

E/ECE/324 }
E/ECE/TRANS/505 } Rev.1/Add.94/Amend.3

10 September 2003

AGREEMENT

**CONCERNING THE ADOPTION OF UNIFORM TECHNICAL PRESCRIPTIONS
FOR WHEELED VEHICLES, EQUIPMENT AND PARTS WHICH CAN BE FITTED
AND/OR BE USED ON WHEELED VEHICLES AND THE CONDITIONS FOR
RECIPROCAL RECOGNITION OF APPROVALS GRANTED ON THE BASIS OF
THESE PRESCRIPTIONS */**

(Revision 2, including the amendments which entered into force on 16 October 1995)

Addendum 94: Regulation No. 95

Amendment 3

02 series of amendments - Date of entry into force: 16 July 2003

**UNIFORM PROVISIONS CONCERNING THE APPROVAL OF VEHICLES
WITH REGARD TO THE PROTECTION OF THE OCCUPANTS
IN THE EVENT OF A LATERAL COLLISION**



UNITED NATIONS

*/ Former title of the Agreement:

Agreement Concerning the Adoption of Uniform Conditions of Approval and Reciprocal Recognition of Approval for Motor Vehicle Equipment and Parts, done at Geneva on 20 March 1958.

Paragraphs 10. to 10.3., amend to read:

"10. TRANSITIONAL PROVISIONS

- 10.1. As from the official date of entry into force of the 02 series of amendments, no Contracting Party applying this Regulation shall refuse to grant ECE approval under this Regulation as amended by the 02 series of amendments.
- 10.2. As from 12 months after the entry into force of the 02 series of amendments Contracting Parties applying this Regulation shall grant ECE approvals only to those types of vehicles which comply with the requirements of this Regulation as amended by the 02 series of amendments.
- 10.3. As from 60 months after the entry into service of the 02 series of amendments Contracting Parties applying this Regulation may refuse first national registration (first entry into service) of vehicles which do not meet the requirements of this Regulation as amended by the 02 series of amendments."

Annex 5, amend to read:

"Annex 5

MOBILE DEFORMABLE BARRIER CHARACTERISTICS

1. CHARACTERISTICS OF THE MOBILE DEFORMABLE BARRIER
- 1.1. The mobile deformable barrier (MDB) includes both an impactor and a trolley.
- 1.2. The total mass shall be 950 ± 20 kg.
- 1.3. The centre of gravity shall be situated in the longitudinal median vertical plane within 10 mm, $1,000 \pm 30$ mm behind the front axle and 500 ± 30 mm above the ground.
- 1.4. The distance between the front face of the impactor and the centre of gravity of the barrier shall be $2,000 \pm 30$ mm.
- 1.5. The ground clearance of the impactor shall be 300 ± 5 mm measured in static conditions from the lower edge of the lower front plate, before the impact.
- 1.6. The front and rear track width of the trolley shall be $1,500 \pm 10$ mm.
- 1.7. The wheelbase of the trolley shall be $3,000 \pm 10$ mm.

2. CHARACTERISTICS OF THE IMPACTOR

The impactor consists of six single blocks of aluminium honeycomb, which have been processed in order to give a progressively increasing level of force with increasing deflection (see paragraph 2.1.). Front and rear aluminium plates are attached to the aluminium honeycomb blocks.

2.1. Honeycomb blocks

2.1.1. Geometrical characteristics

2.1.1.1. The impactor consists of 6 joined zones whose forms and positioning are shown in figures 1 and 2. The zones are defined as 500 ± 5 mm x 250 ± 3 mm in figures 1 and 2. The 500 mm should be in the W direction and the 250 mm in the L direction of the aluminium honeycomb construction (see figure 3).

2.1.1.2. The impactor is divided into 2 rows. The lower row shall be 250 ± 3 mm high, and 500 ± 2 mm deep after pre-crush (see paragraph 2.1.2.), and deeper than the upper row by 60 ± 2 mm.

2.1.1.3. The blocks must be centred on the six zones defined in figure 1 and each block (including incomplete cells) should cover completely the area defined for each zone).

2.1.2. Pre-crush

2.1.2.1. The pre-crush shall be performed on the surface of the honeycomb to which the front sheets are attached.

2.1.2.2. Blocks 1, 2 and 3 should be crushed by 10 ± 2 mm on the top surface prior to testing to give a depth of 500 ± 2 mm (figure 2).

2.1.2.3. Blocks 4, 5 and 6 should be crushed by 10 ± 2 mm on the top surface prior to testing to give a depth of 440 ± 2 mm.

2.1.3. Material characteristics

2.1.3.1. The cell dimensions shall be 19 mm ± 10 per cent for each block (see figure 4).

2.1.3.2. The cells must be made of 3003 aluminium for the upper row.

2.1.3.3. The cells must be made of 5052 aluminium for the lower row.

2.1.3.4. The aluminium honeycomb blocks should be processed such that the force deflection-curve when statically crushed (according to the procedure defined in

paragraph 2.1.4.) is within the corridors defined for each of the six blocks in appendix 1 to this annex. Moreover, the processed honeycomb material used in the honeycomb blocks to be used for constructing the barrier, should be cleaned in order to remove any residue that may have been produced during the processing of the raw honeycomb material.

- 2.1.3.5. The mass of the blocks in each batch shall not differ by more than 5 per cent of the mean block mass for that batch.
- 2.1.4. Static tests
- 2.1.4.1. A sample taken from each batch of processed honeycomb core shall be tested according to the static test procedure described in paragraph 5.
- 2.1.4.2. The force-compression for each block tested shall lie within the force deflection corridors defined in appendix 1. Static force-deflection corridors are defined for each block of the barrier.
- 2.1.5. Dynamic test
- 2.1.5.1. The dynamic deformation characteristics, when impacted according to the protocol described in paragraph 6.
- 2.1.5.2. Deviation from the limits of the force-deflection corridors characterising the rigidity of the impactor - as defined in appendix 2 - may be allowed provided that:
- 2.1.5.2.1. the deviation occurs after the beginning of the impact and before the deformation of the impactor is equal to 150 mm;
- 2.1.5.2.2. the deviation does not exceed 50 per cent of the nearest instantaneous prescribed limit of the corridor;
- 2.1.5.2.3. each deflection corresponding to each deviation does not exceed 35 mm of deflection, and the sum of these deflections does not exceed 70 mm (see appendix 2 to this annex);
- 2.1.5.2.4. the sum of energy derived from deviating outside the corridor does not exceed 5 per cent of the gross energy for that block.
- 2.1.5.3. Blocks 1 and 3 are identical. Their rigidity is such that their force deflection curves fall between corridors of figure 2a.
- 2.1.5.4. Blocks 5 and 6 are identical. Their rigidity is such that their force deflection curves fall between corridors of figure 2d.

- 2.1.5.5 The rigidity of block 2 is such that its force deflection curves fall between corridors of figure 2b.
- 2.1.5.6. The rigidity of block 4 is such that its force deflection curves fall between corridors of figure 2c.
- 2.1.5.7. The force-deflection of the impactor as a whole shall fall between corridors of figure 2e.
- 2.1.5.8. The force-deflection curves shall be verified by a test detailed in annex 5, paragraph 6., consisting of an impact of the barrier against a dynamometric wall at 35 ± 0.5 km/h.
- 2.1.5.9. The dissipated energy 1/ against blocks 1 and 3 during the test shall be equal to 9.5 ± 2 kJ for these blocks.
- 2.1.5.10. The dissipated energy against blocks 5 and 6 during the test shall be equal to 3.5 ± 1 kJ for these blocks.
- 2.1.5.11. The dissipated energy against block 4 shall be equal to 4 ± 1 kJ.
- 2.1.5.12. The dissipated energy against block 2 shall be equal to 15 ± 2 kJ.
- 2.1.5.13. The dissipated total energy during the impact shall be equal to 45 ± 3 kJ.
- 2.1.5.14. The maximum impactor deformation from the point of first contact, calculated from integration of the accelerometers according to paragraph 6.6.3., shall be equal to 330 ± 20 mm.
- 2.1.5.15. The final residual static impactor deformation measured after the dynamic test at level B (figure 2) shall be equal to 310 ± 20 mm.
- 2.2. Front plates
- 2.2.1. Geometrical characteristics
- 2.2.1.1. The front plates are $1,500 \pm 1$ mm wide and 250 ± 1 mm high. The thickness is 0.5 ± 0.06 mm.
- 2.2.1.2. When assembled the overall dimensions of the impactor (defined in figure 2) shall be: $1,500 \pm 2.5$ mm wide and 500 ± 2.5 mm high.

1/ The amounts of energy indicated are the amounts of energy dissipated by the system when the extent to which the impactor is crushed is greatest.

- 2.2.1.3. The upper edge of the lower front plate and the lower edge of the upper front plate should be aligned within 4 mm.
- 2.2.2. Material characteristics
- 2.2.2.1. The front plates are manufactured from aluminium of series AlMg₂ to AlMg₃ with elongation ≥ 12 per cent, and a UTS ≥ 175 N/mm².
- 2.3. Back plate
- 2.3.1. Geometric characteristics
- 2.3.1.1. The geometric characteristics shall be according to figures 5 and 6.
- 2.3.2. Material characteristics
- 2.3.2.1. The back plate shall consist of a 3 mm aluminium sheet. The back plate shall be manufactured from aluminium of series AlMg₂ to AlMg₃ with a hardness between 50 and 65 HBS. This plate shall be perforated with holes for ventilation: the location, the diameter and pitch are shown in figures 5 and 7.
- 2.4. Location of the honeycomb blocks
- 2.4.1. The honeycomb blocks shall be centred on the perforated zone of the back plate (figure 5).
- 2.5. Bonding
- 2.5.1. For both the front and the back plates, a maximum of 0.5 kg/m² shall be applied evenly directly over the surface of the front plate, giving a maximum film thickness of 0.5 mm. The adhesive to be used throughout should be a two-part polyurethane {such as Ciba Geigy XB5090/1 resin with XB5304 hardener} or equivalent.
- 2.5.2. For the back plate the minimum bonding strength shall be 0.6 MPa, (87 psi), tested according to paragraph 2.4.3.
- 2.5.3. Bonding strength tests:
- 2.5.3.1. Flatwise tensile testing is used to measure bond strength of adhesives according to ASTM C297-61.
- 2.5.3.2. The test piece should be 100 mm x 100 mm, and 15 mm deep, bonded to a sample of the ventilated back plate material. The honeycomb used should be representative of that in the impactor, i.e. chemically etched to an equivalent degree as that near to the back plate in the barrier but without pre-crushing.

2.6. Traceability

- 2.6.1. Impactors shall carry consecutive serial numbers which are stamped, etched or otherwise permanently attached, from which the batches for the individual blocks and the date of manufacture can be established

2.7. Impactor attachment

- 2.7.1. The fitting on the trolley must be according to figure 8. The fitting will use six M8 bolts, and nothing shall be larger than the dimensions of the barrier in front of the wheels of the trolley. Appropriate spacers must be used between the lower back plate flange and the trolley face to avoid bowing of the back plate when the attachment bolts are tightened.

3. VENTILATION SYSTEM

- 3.1. The interface between the trolley and the ventilation system should be solid, rigid and flat. The ventilation device is part of the trolley and not of the impactor as supplied by the manufacturer. Geometrical characteristics of the ventilation device shall be according to figure 9.

3.2. Ventilation device mounting procedure.

- 3.2.1. Mount the ventilation device to the front plate of the trolley;

- 3.2.2. Ensure that a 0.5 mm thick gauge cannot be inserted between the ventilation device and the trolley face at any point. If there is a gap greater than 0.5 mm, the ventilation frame will need to be replaced or adjusted to fit without a gap of > 0.5 mm.

- 3.2.3. Dismount the ventilation device from the front of the trolley;

- 3.2.4. Fix a 1.0 mm thick layer of cork to the front face of the trolley;

- 3.2.5. Re-mount the ventilation device to the front of the trolley and tighten to exclude air gaps.

4. CONFORMITY OF PRODUCTION

The conformity of production procedures shall comply with those set out in the Agreement, Appendix 2 (E/ECE/324-E/ECE/TRANS/505/Rev.2), with the following requirements:

- 4.1. The manufacturer shall be responsible for the conformity of production procedures and for that purpose must in particular:
 - 4.1.1. Ensure the existence of effective procedures so that the quality of the products can be inspected,
 - 4.1.2. Have access to the testing equipment needed to inspect the conformity of each product,
 - 4.1.3. Ensure that the test results are recorded and that the documents remain available for a time period of 10 years after the tests,
 - 4.1.4. Demonstrate that the samples tested are a reliable measure of the performance of the batch (examples of sampling methods according to batch production are given below).
 - 4.1.5. Analyse results of tests in order to verify and ensure the stability of the barrier characteristics, making allowance for variations of an industrial production, such as temperature, raw materials quality, time of immersion in chemical, chemical concentration, neutralisation etc, and the control of the processed material in order to remove any residue from the processing,
 - 4.1.6. Ensure that any set of samples or test pieces giving evidence of non-conformity gives rise to a further sampling and test. All the necessary steps must be taken to restore conformity of the corresponding production.
- 4.2. The manufacturer's level of certification must be at least ISO 9002 standard.
- 4.3. Minimum conditions for the control of production: the holder of an agreement will ensure the control of conformity following the methods hereunder described.
- 4.4. Examples of sampling according to batch
 - 4.4.1. If several examples of one block type are constructed from one original block of aluminium honeycomb and are all treated in the same treatment bath (parallel production), one of these examples could be chosen as the sample, provided care is taken to ensure that the treatment is evenly applied to all blocks. If not, it may be necessary to select more than one sample.
 - 4.4.2. If a limited number of similar blocks (say three to twenty) are treated in the same bath (serial production), then the first and last block treated in a batch, all of which are constructed from the same original block of aluminium honeycomb, should be taken as representative samples. If the first sample complies with the requirements but the last does not, it may be necessary to take further samples from earlier in the

production until a sample that does comply is found. Only the blocks between these samples should be considered to be approved.

- 4.4.3. Once experience is gained with the consistency of production control, it may be possible to combine both sampling approaches, so that more than one groups of parallel production can be considered to be a batch provided samples from the first and last production groups comply.

5. STATIC TESTS

- 5.1. One or more samples (according to the batch method) taken from each batch of processed honeycomb core shall be tested, according to the following test procedure:
- 5.2. The sample size of the aluminium honeycomb for static tests shall be the size of a normal block of the impactor, that is to say 250 mm x 500 mm x 440 mm for top row and 250 mm x 500 mm x 500 mm for the bottom row.
- 5.3. The samples should be compressed between two parallel loading plates which are at least 20 mm larger than the block cross section.
- 5.4. The compression speed shall be 100 millimetres per minute, with a tolerance of 5 per cent.
- 5.5. The data acquisition for static compression shall be sampled at a minimum of 5 Hz.
- 5.6. The static test shall be continued until the block compression is at least 300 mm for blocks 4 to 6 and 350 mm for blocks 1 to 3.

6. DYNAMIC TESTS

For every 100 barrier faces produced, the manufacturer shall make one dynamic test against a dynamometric wall supported by a fixed rigid barrier, according to the method described below.

6.1. Installation

6.1.1. Testing ground

- 6.1.1.1. The test area shall be large enough to accommodate the run-up-track of the mobile deformable barrier, the rigid barrier and the technical equipment necessary for the test. The last part of the track, for at least 5 metres before the rigid barrier, shall be horizontal, flat and smooth.

6.1.2. Fixed rigid barrier and dynamometric wall

- 6.1.2.1. The rigid wall shall consist of a block of reinforced concrete not less than 3 metres wide and not less than 1.5 metres high. The thickness of the rigid wall shall be such that it weighs at least 70 tonnes.
- 6.1.2.2. The front face shall be vertical, perpendicular to the axis of the run-up-tack and equipped with six load cell plates, each capable of measuring the total load on the appropriate block of the mobile deformable barrier impactor at the moment of impact. The load cell impact plate area centres shall align with those of the six impact zones of the mobile deformable barrier face. Their edges shall clear adjacent areas by 20 mm such that, within the tolerance of impact alignment of the MDB, the impact zones will not contact the adjacent impact plate areas. Cell mounting and plate surfaces shall be in accordance with the requirements set out in the annex to standard ISO 6487:1987.
- 6.1.2.3. Surface protection, comprising a plywood face (thickness: 12 ± 1 mm), is added to each load cell plate such that it shall not degrade the transducer responses.
- 6.1.2.4. The rigid wall shall be either anchored in the ground or placed on the ground with, if necessary, additional arresting devices to limit its deflection. A rigid wall (to which the load cells are attached) having different characteristics but giving results that are at least equally conclusive may be used.

6.2. Propulsion of the mobile deformable barrier

At the moment of impact the mobile deformable barrier shall no longer be subject to the action of any additional steering or propelling device. It shall reach the obstacle on a course perpendicular to the front surface of the dynamometric wall. Impact alignment shall be accurate to within 10 mm.

6.3. Measuring instruments

6.3.1. Speed

The impact speed shall be 35 ± 0.5 km/h the instrument used to record the speed on impact shall be accurate to within 0.1 percent.

6.3.2. Loads

Measuring instruments shall meet the specifications set forth in ISO 6487:1987

CFC for all blocks:	60 Hz
CAC for blocks 1 and 3:	200 kN
CAC for blocks 4,5 and 6:	100 kN
CAC for block 2:	200 kN

6.3.3. Acceleration

6.3.3.1. The acceleration in the longitudinal direction shall be measured at three separate positions on the trolley, one centrally and one at each side, at places not subject to bending.

6.3.3.2. The central accelerometer shall be located within 500 mm of the location of the centre of gravity of the MDB and shall lie in a vertical longitudinal plane which is within ± 10 mm of the centre of gravity of the MDB.

6.3.3.3. The side accelerometers shall be at the same height as each other ± 10 mm and at the same distance from the front surface of the MDB ± 20 mm

6.3.3.4. The instrumentation shall comply with ISO 6487:1987 with the following specifications:

CFC 1,000 Hz (before integration)
CAC 50 g

6.4. General specifications of barrier

6.4.1. The individual characteristics of each barrier shall comply with paragraph 1. of this annex and shall be recorded.

6.5. General specifications of the impactor

6.5.1. The suitability of an impactor as regards the dynamic test requirements shall be confirmed when the outputs from the six load cell plates each produce signals complying with the requirements indicated in this annex.

6.5.2. Impactors shall carry consecutive serial numbers which are stamped, etched or otherwise permanently attached, from which the batches for the individual blocks and the date of manufacture can be established.

6.6. Data processing procedure

6.6.1. Raw data: At time $T = T_0$, all offsets should be removed from the data. The method by which offsets are removed shall be recorded in the test report.

6.6.2. Filtering

6.6.2.1. The raw data will be filtered prior to processing/calculations.

6.6.2.2. Accelerometer data for integration will be filtered to CFC 180, ISO 6487:1987.

- 6.6.2.3. Accelerometer data for impulse calculations will be filtered to CFC 60, ISO 6487:1987.
- 6.6.2.4. Load cell data will be filtered to CFC 60, ISO 6487:1987.
- 6.6.3. Calculation of MDB face deflection
- 6.6.3.1. Accelerometer data from all three accelerometers individually (after filtering at CFC 180), will be integrated twice to obtain deflection of the barrier deformable element.
- 6.6.3.2. The initial conditions for deflection are:
- 6.6.3.2.1. velocity = impact velocity (from speed measuring device).
- 6.6.3.2.2. deflection = 0
- 6.6.3.3. The deflection at the left hand side, mid-line and right hand side of the mobile deformable barrier will be plotted with respect to time.
- 6.6.3.4. The maximum deflection calculated from each of the three accelerometers should be within 10 mm. If it is not the case, then the outlier should be removed and difference between the deflection calculated from the remaining two accelerometers checked to ensure that it is within 10 mm.
- 6.6.3.5. If the deflections as measured by the left hand side, right hand side and mid-line accelerometers are within 10 mm, then the mean acceleration of the three accelerometers should be used to calculate the deflection of the barrier face.
- 6.6.3.6. If the deflection from only two accelerometers meets the 10 mm requirement, then the mean acceleration from these two accelerometers should be used to calculate the deflection for the barrier face.
- 6.6.3.7. If the deflections calculated from all three accelerometers (left hand side, right hand side and mid-line) are NOT within the 10 mm requirement, then the raw data should be reviewed to determine the causes of such large variation. In this case the individual test house will determine which accelerometer data should be used to determine mobile deformable barrier deflection or whether none of the accelerometer readings can be used, in which case, the certification test must be repeated. A full explanation should be given in the test report.
- 6.6.3.8. The mean deflection-time data will be combined with the load cell wall force-time data to generate the force-deflection result for each block.

6.6.4. Calculation of energy

The absorbed energy for each block and for the whole MDB face should be calculated up to the point of peak deflection of the barrier.

$$E_n = \int_{t_0}^{t_1} F_n \cdot ds_{\text{mean}}$$

where:

t_0 is the time of first contact

t_1 is the time where the trolley comes to rest, i.e. where $u = 0$.

s is the deflection of the trolley deformable element calculated according to paragraph 6.6.3.

6.6.5. Verification of dynamic force data

6.6.5.1. Compare the total impulse, I , calculated from the integration of the total force over the period of contact, with the momentum change over that period ($M \cdot \Delta V$).

6.6.5.2. Compare the total energy change to the change in kinetic energy of the MDB, given by:

$$E_K = \frac{1}{2} M V_i^2$$

where V_i is the impact velocity and M the whole mass of the MDB

If the momentum change ($M \cdot \Delta V$) is not equal to the total impulse ($I \pm 5$ per cent), or if the total energy absorbed ($\sum E_n$) is not equal to the kinetic energy, $E_K \pm 5$ per cent, then the test data must be examined to determine the cause of this error.

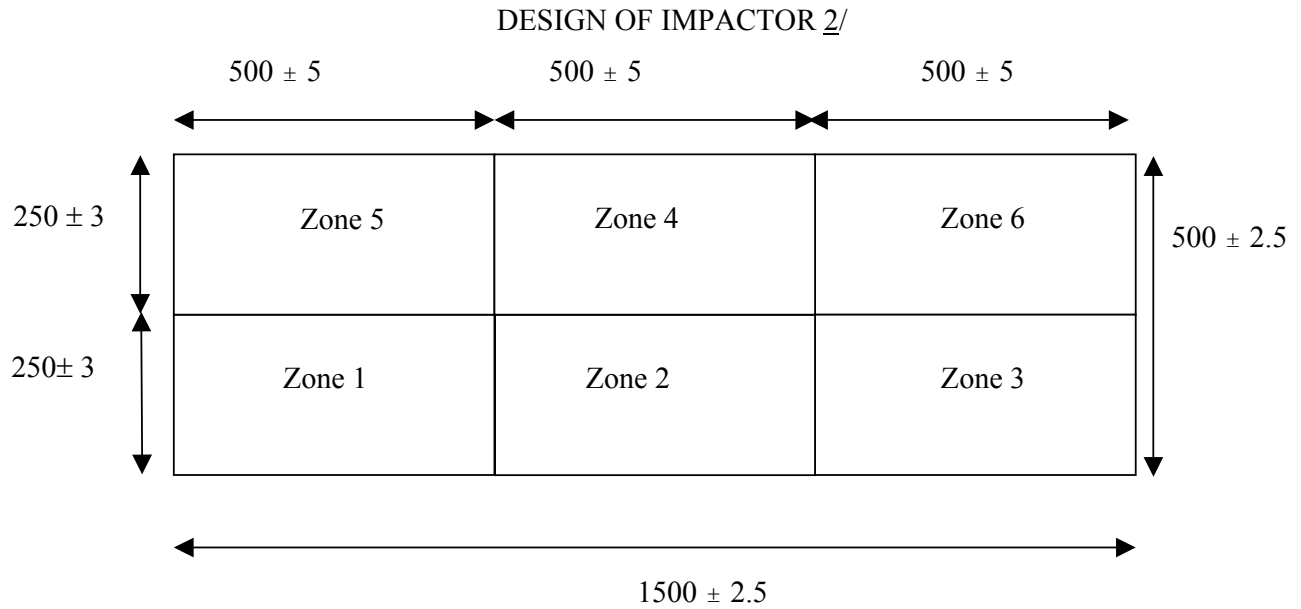

Figure 1

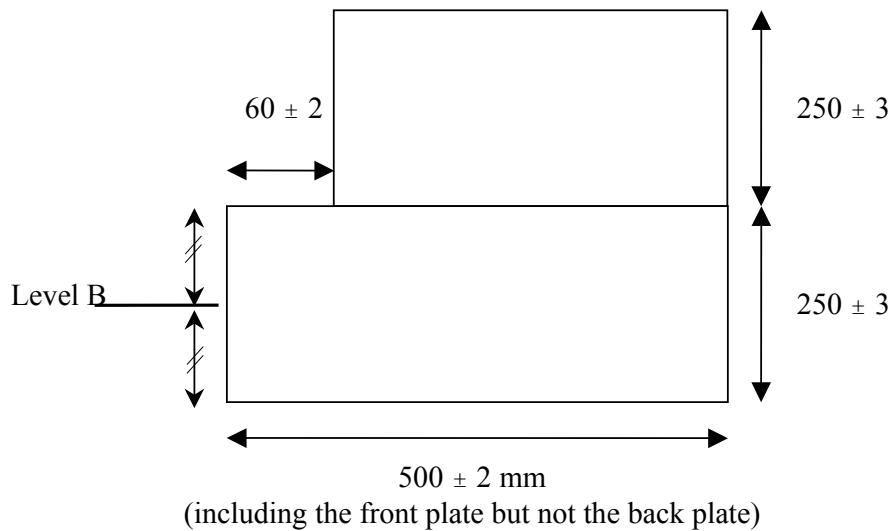

Figure 2

2/ All dimensions are in mm. The tolerances on the dimensions of the blocks allow for the difficulties of measuring cut aluminium honeycomb. The tolerance on the overall dimension of the impactor is less than that for the individual blocks since the honeycomb blocks can be adjusted, with overlap if necessary, to maintain a more closely defined impact face dimension.

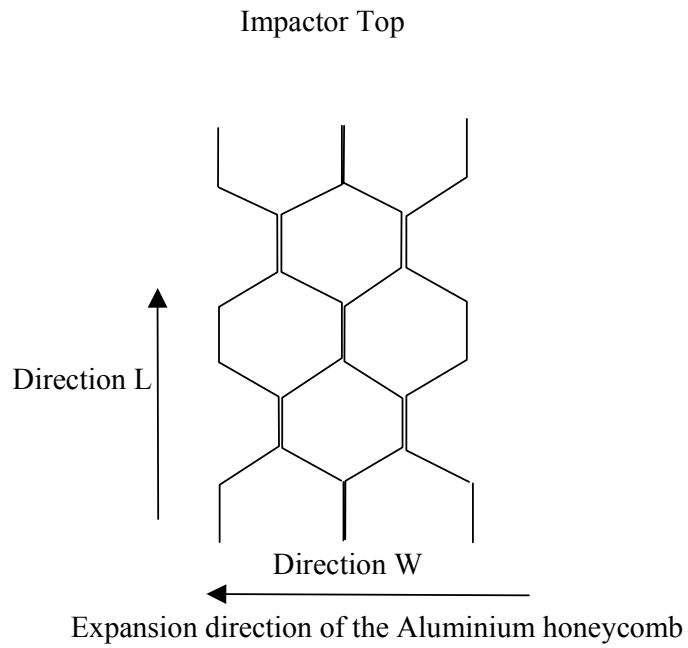

Figure 3 - Aluminium Honeycomb Orientation

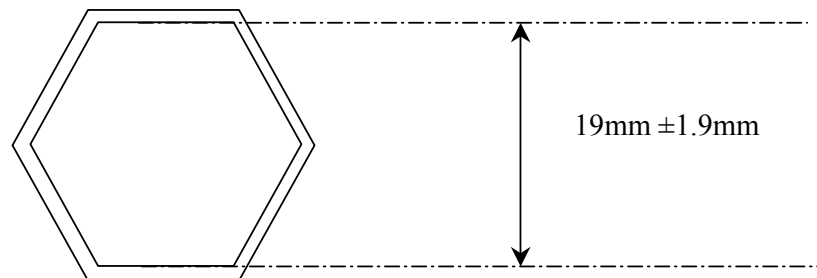

Figure 4 - Dimension of Aluminium Honeycomb Cells

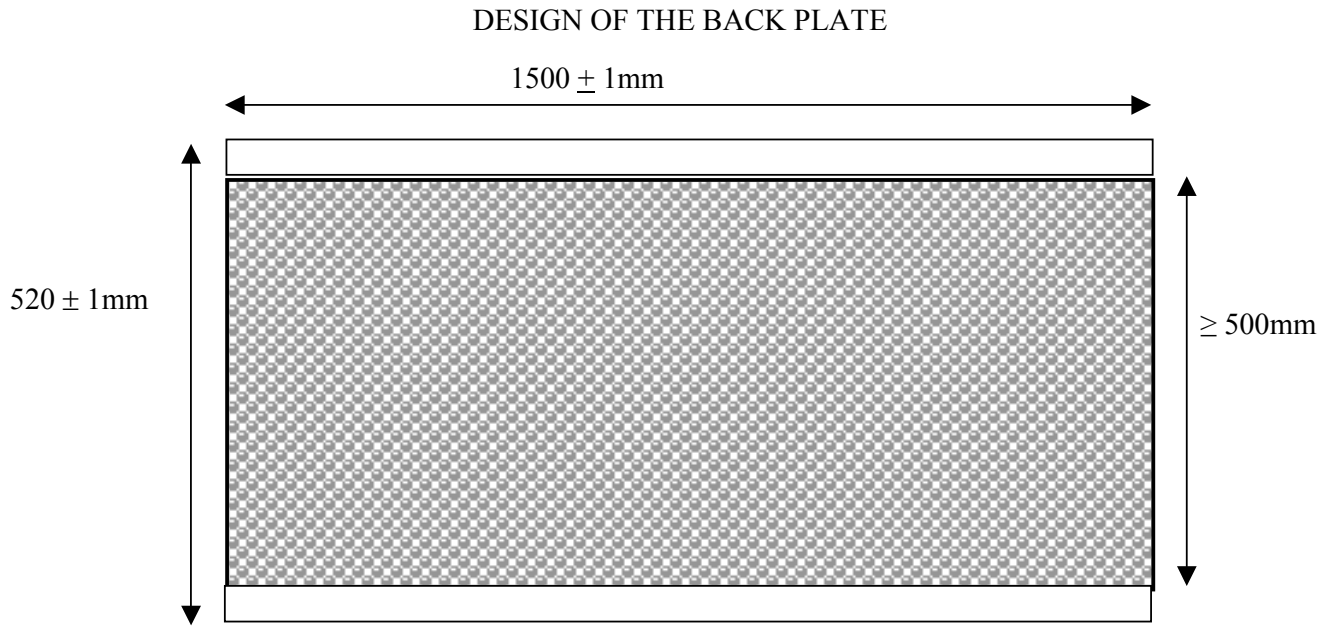
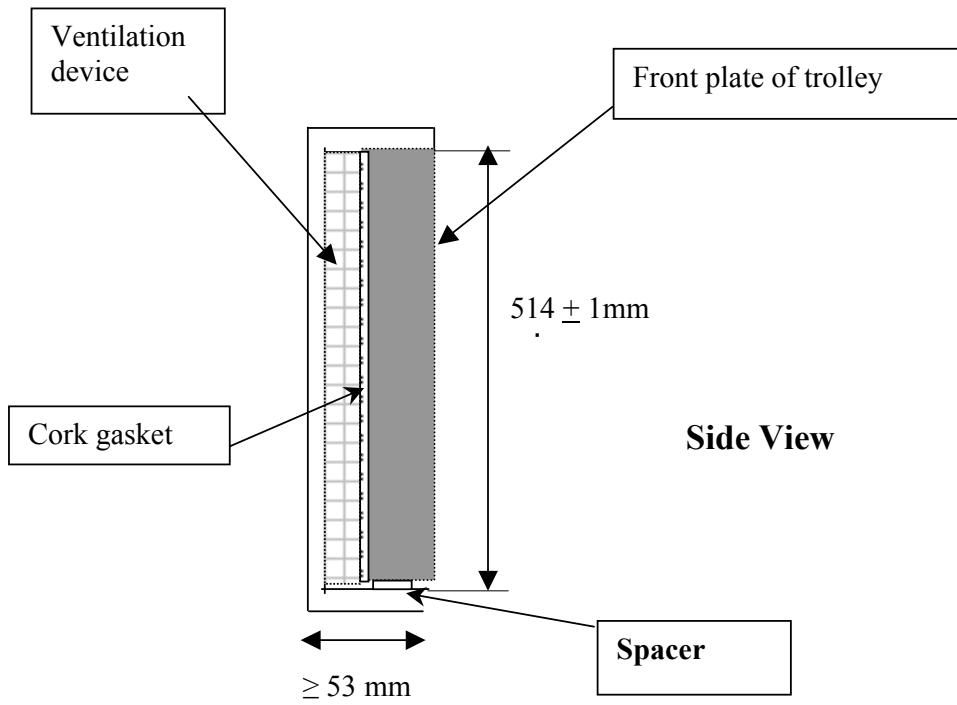

Figure 5

Front View



Side View

Figure 6

Attachment of backplate to ventilation device and trolley face plate

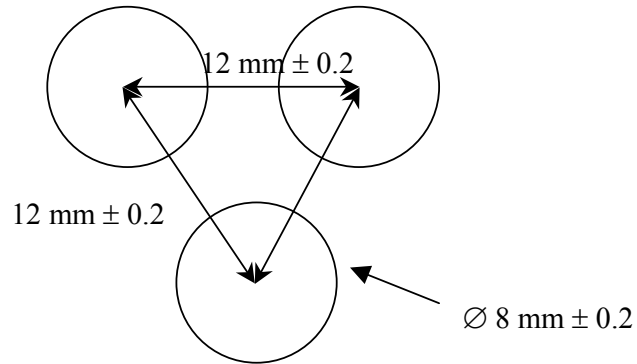
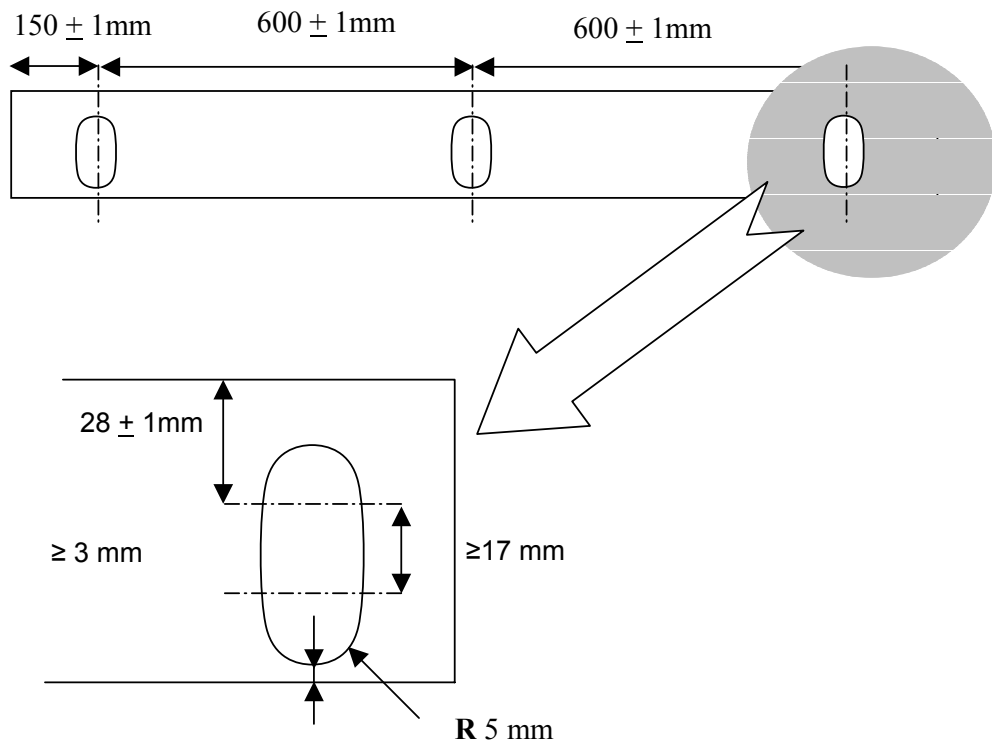

Figure 7 - Staggered pitch for the back plate ventilation holes



Top and bottom back plate flanges

Note: The attachment holes in the bottom flange may be opened to slots, as shown below, for ease of attachment provided sufficient grip can be developed to avoid detachment during the whole impact test.

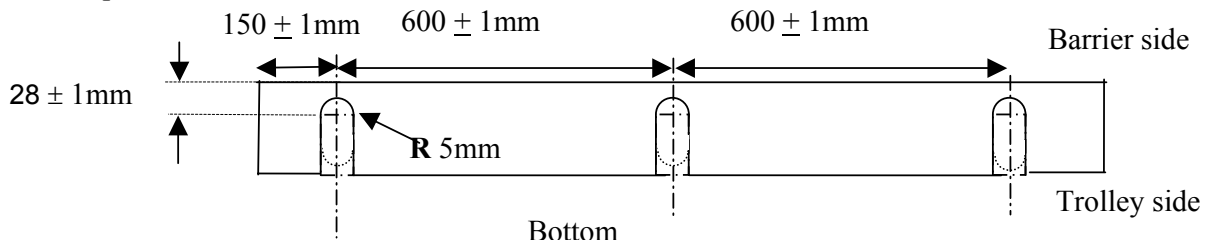
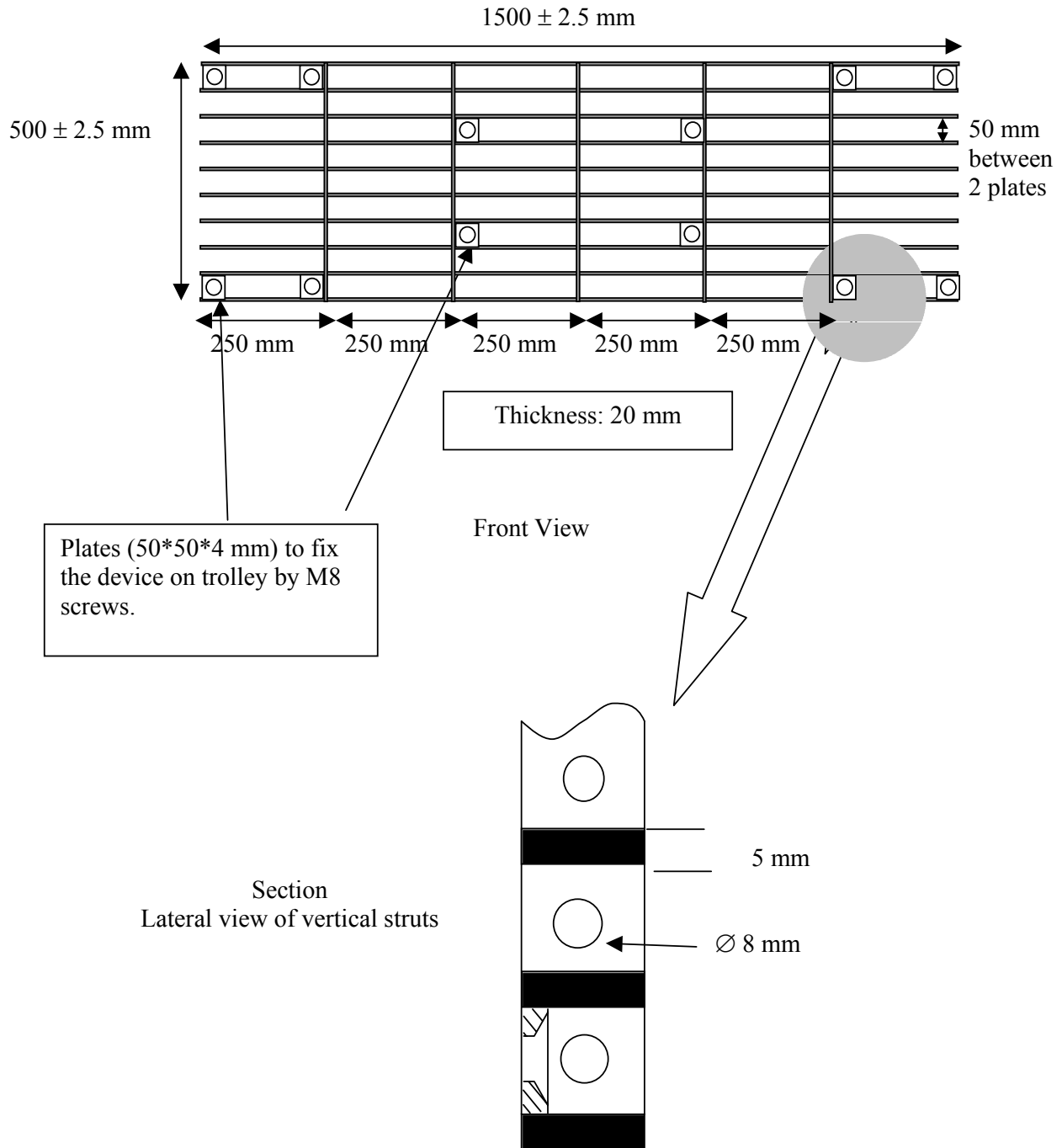

Figure 8

VENTILATION FRAME

The ventilation device is a structure made of a plate that is 5 mm thick and 20 mm wide. Only the vertical plates are perforated with nine 8 mm holes in order to let air circulate horizontally.



Side View
 Figure 9

"

Annex 5, Appendices 1 and 2, amend to read:

"Annex 5 - Appendix 1

FORCE-DEFLECTION CURVES FOR STATIC TESTS

Blocks 1 & 3
Figure 1a

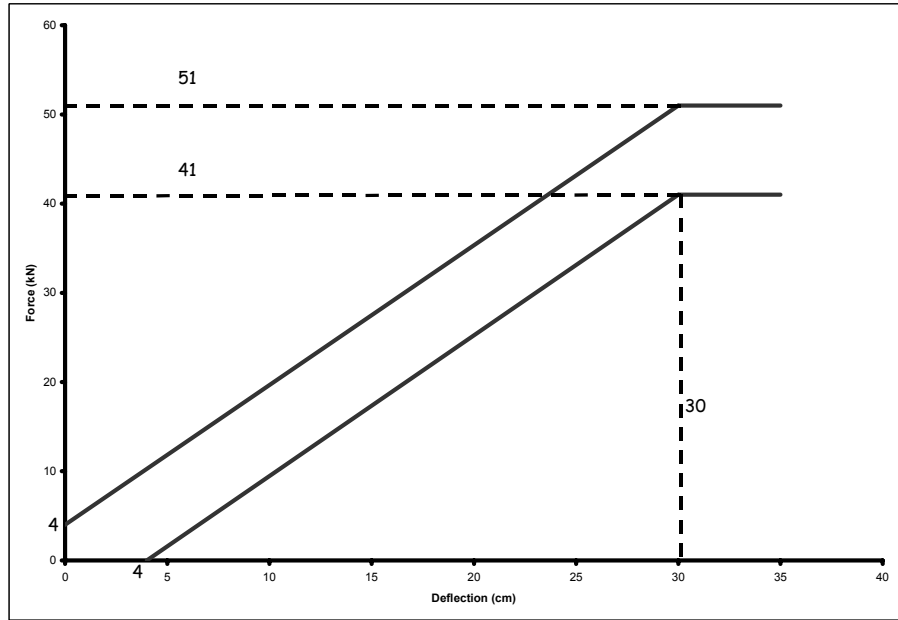

Block 2
Figure 1b

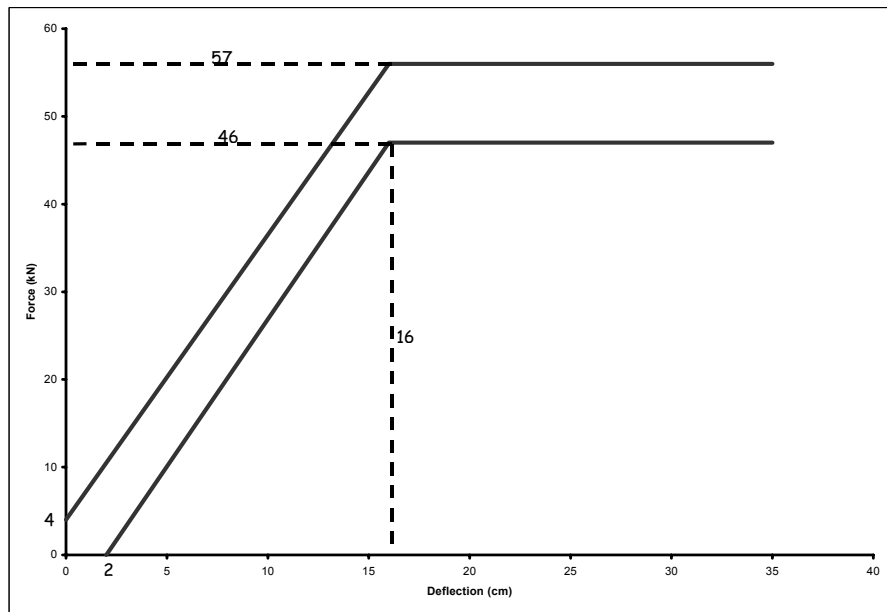

Block 4
Figure 1c

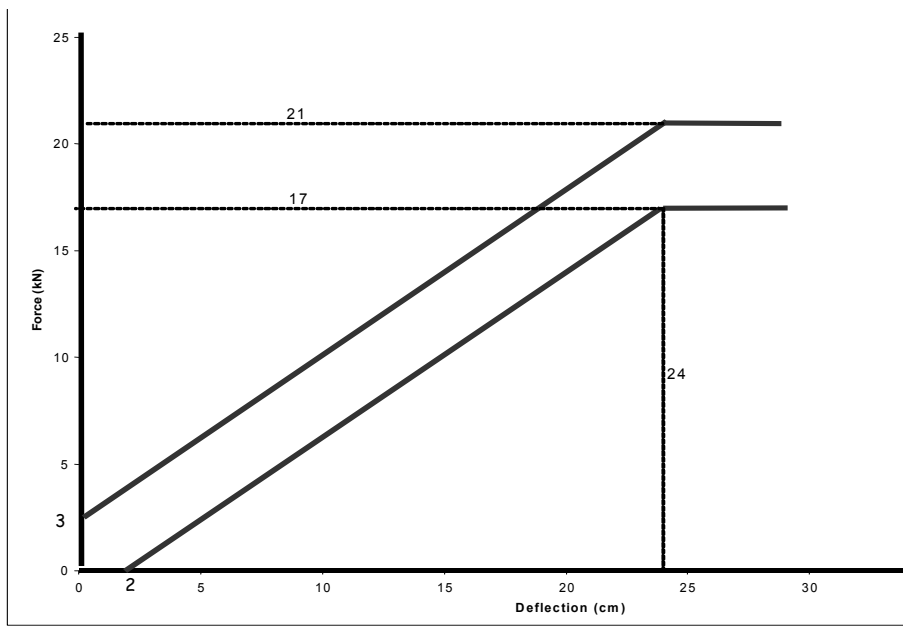

Blocks 5 & 6
Figure 1d

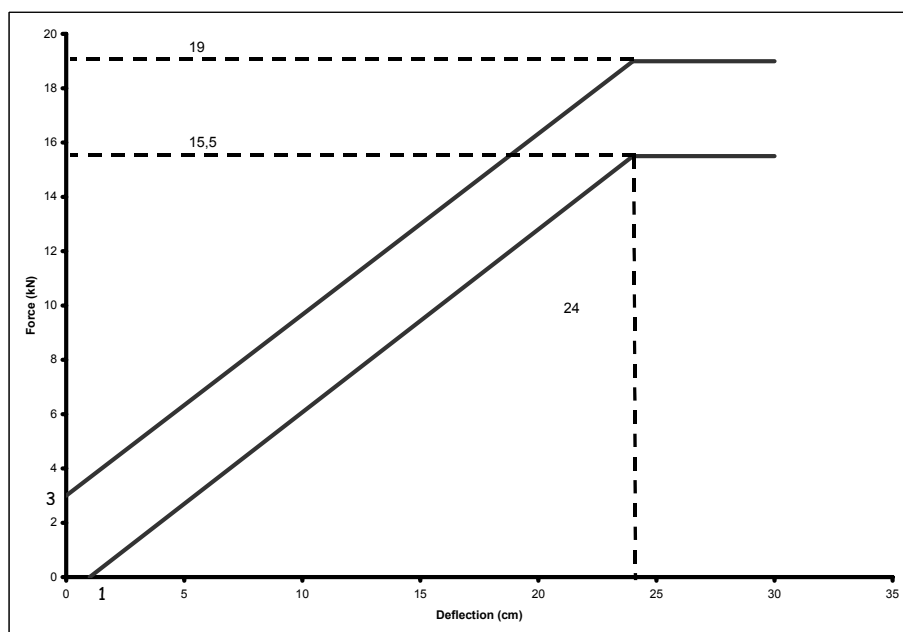

Annex 5 - Appendix 2

FORCE-DEFLECTION CURVES FOR DYNAMIC TESTS

Blocks 1 & 3
Figure 2a

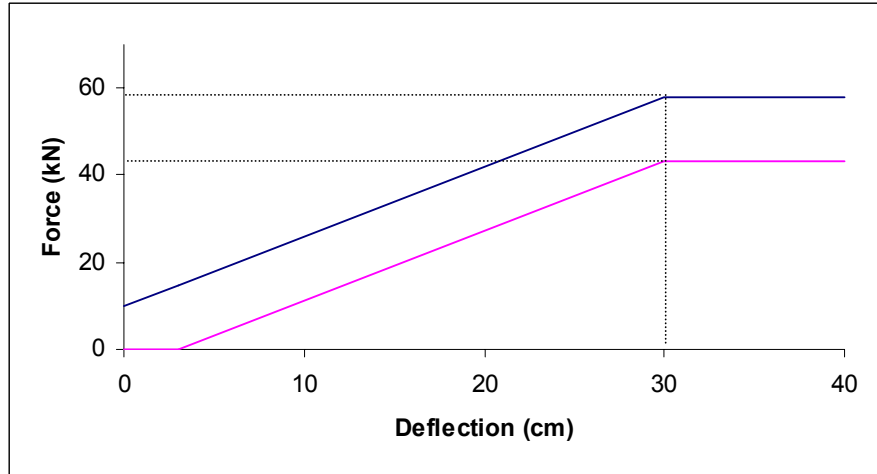

Block 2
Figure 2b

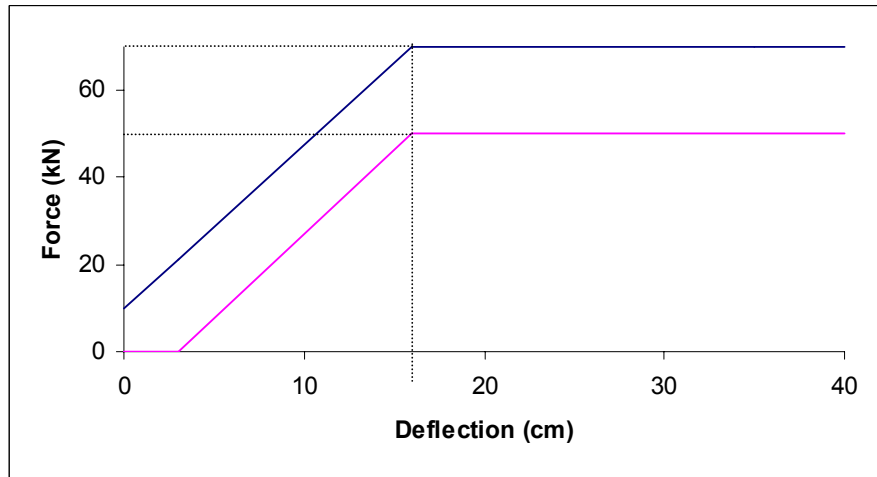

Block 4
Figure 2c

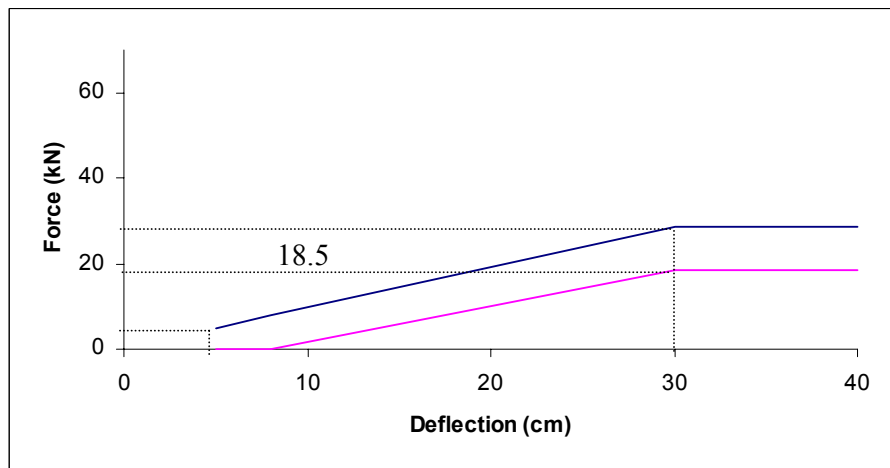

Blocks 5 & 6
Figure 2d

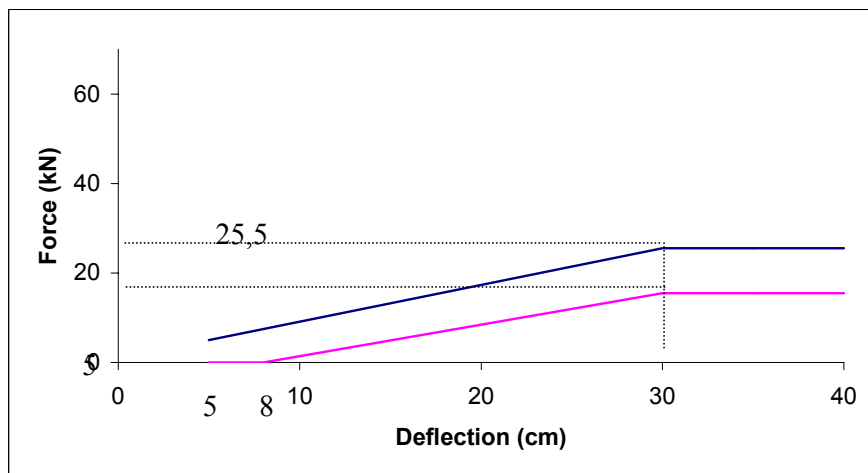

Blocks total
Figure 2e

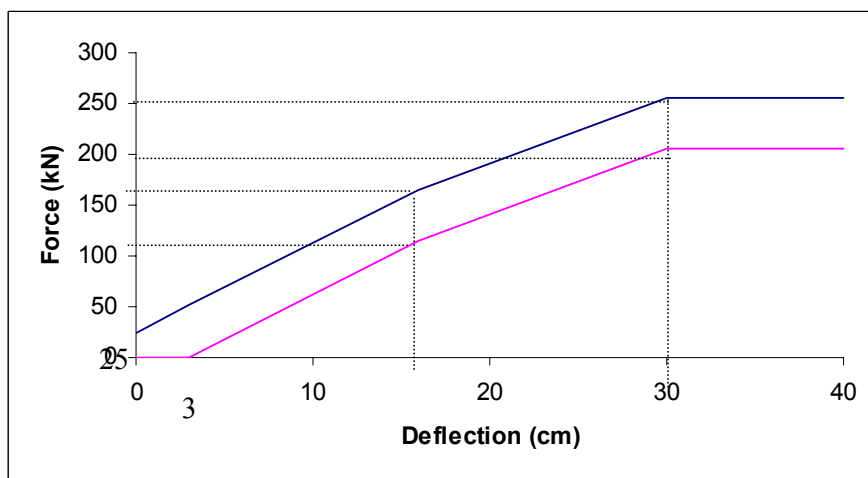

"