



Economic and Social Council

Distr.: General
8 April 2024

Original: English

Economic Commission for Europe

Inland Transport Committee

World Forum for Harmonization of Vehicle Regulations

193rd session

Geneva, 25–28 June 2024

Item 4.9.4 of the provisional agenda

1958 Agreement:

Consideration of draft amendments to existing

UN Regulations submitted by GRBP

Proposal for the 02 series of amendments to UN Regulation No. 138 (Quiet road transport vehicles)

Submitted by the Working Party on Noise and Tyres*

The text reproduced below was adopted by the Working Party on Noise and Tyres (GRBP) at its seventy-ninth session (ECE/TRANS/WP.29/GRBP/77, para. 16). It is based on ECE/TRANS/WP.29/GRBP/2024/2 as amended by GRBP-79-34-Rev.2. It is submitted to the World Forum for Harmonization of Vehicle Regulations (WP.29) and to the Administrative Committee (AC.1) for consideration at their June 2024 sessions.

* In accordance with the programme of work of the Inland Transport Committee for 2024 as outlined in proposed programme budget for 2024 (A/78/6 (Sect. 20), table 20.5), the World Forum will develop, harmonize and update UN Regulations in order to enhance the performance of vehicles. The present document is submitted in conformity with that mandate.



Uniform provisions concerning the approval of Quiet Road Transport Vehicles with regard to their reduced audibility

Contents

	<i>Page</i>
Regulation	
1. Scope.....	3
2. Definitions	3
3. Application for approval	6
4. Markings	7
5. Approval	7
6. Specifications	8
7. Modification and extension of approval of a vehicle type	11
8. Conformity of production.....	12
9. Penalties for non-conformity of production	12
10. Production definitively discontinued.....	12
11. Transitional provisions	13
12. Names and addresses of Technical Services responsible for conducting approval tests and of Type Approval Authorities.....	13
Annexes	
1. Communication.....	14
Addendum to the Communication Form (Technical Information document)	16
2. Arrangements of the approval mark	19
3. Methods and instruments for measuring the sound made by motor vehicles	20
Appendix: Figures and Flowcharts.....	32
4. Statement of compliance of Quiet Road Transport Vehicles (QRTV) with regard to their reduced audibility	41

1. Scope

This Regulation applies to electrified vehicles of categories M and N¹ which can be propelled in the normal mode, in reverse or at least one forward drive gear, without an internal combustion engine operating² in respect to their reduced audibility³.

2. Definitions

For the purpose of this Regulation,

- 2.1. "*Approval of a vehicle*" means the approval of a vehicle type with regard to sound;
- 2.2. "*Natural sound*" means sound coming from the vehicle and its components as a result of e.g. providing propulsion, braking, steering, cooling, or any other function.
- An exterior sound enhancement system, as defined in UN Regulation No. 51, Annex 9, paragraph 2.2. does not produce natural sound.
- 2.3. "*Acoustic Vehicle Alerting System*" (AVAS) means a component or set of components installed in vehicles with the primary purpose to fulfil the requirements of this Regulation;
- 2.3.1. "*AVAS sound*" means a synthetic created sound which is controllable by an acoustic vehicle alerting systems. This means the sound(s) and sound characteristic(s) emitted by an Acoustic Vehicle Alerting System (AVAS) to fulfil the requirements of this Regulation. The AVAS sound provides only acoustic safety information to pedestrians and other road users on the vehicle's presence and operation.
- 2.4. "*Vehicle type*" means a category of motor vehicles which does not differ essentially in such respects as:
- 2.4.1. The shape and the materials of the bodywork of the vehicle which affect the sound level emitted.
- 2.4.2. The principle of the drivetrain (from the batteries to the wheels). Notwithstanding the provisions of 2.4.1. vehicles which differ with respect to overall gear ratios, battery type or the fitment of a range extender may be considered vehicles of the same type;
- 2.4.3. If applicable, the number and type(s) of sound emitting devices (hardware) of AVAS fitted on the vehicle;
- 2.4.4. If applicable, the position of the AVAS on the vehicle.
- 2.5. "*Frequency Shift*" means the variation of the frequency content of the AVAS sound as a function of the vehicle speed.
- 2.6. "*Electrified vehicle*" means a vehicle with a powertrain containing at least one electric motor or electric motor-generator.
- 2.6.1. "*Pure Electric Vehicle*" (PEV) means a motor vehicle with an electric motor as its sole mean of propulsion.

¹ As defined in the Consolidated Resolution on the Construction of Vehicles (R.E.3).

² At this stage, only acoustic measures shall be developed in order to overcome the concern of reduced audible signals from electrified vehicles. After finalisation, the appropriate GR shall be assigned with the enhancement of the Regulation in order to develop alternative, non-acoustic measures, taking into account active safety systems such as, but not limited to, pedestrian detection systems. To provide for environmental protection, this Regulation specifies also maximum limits.

³ See paragraph 5.1.1. for more detailed specifications on the application.

- 2.6.2. "Hybrid Electric Vehicle" (HEV) means a vehicle with a powertrain containing at least one electric motor or electric motor generator and at least one internal combustion engine as propulsion energy converters.
- 2.6.3. "Fuel Cell vehicle" (FCV) means a vehicle with a fuel cell and an electric machine as propulsion energy converters.
- 2.6.4. "Fuel Cell Hybrid Vehicle" (FCHV) means a vehicle with at least one fuel storage system and at least one Rechargeable Electric Energy Storage System (REESS) as propulsion energy storage system.
- 2.7. "Mass in running order" means the mass of the vehicle, with its fuel tank(s) filled to at least 90% of its or their capacity/ies, including the mass of the driver (75 kg), of the fuel and liquids, fitted with the standard equipment in accordance with the manufacturer's specifications and, when they are fitted, the mass of the bodywork, the cabin, the coupling and the spare wheel(s) as well as the tools.
- 2.8. "Pause function" means a mechanism to enable the driver to halt the operation of an AVAS.
- 2.9. "Front plane of the vehicle" means a vertical plane tangent to the leading edge of the vehicle.
- 2.10. "Rear plane of the vehicle" means a vertical plane tangent to the trailing edge of the vehicle.
- 2.11. "Mandatory speed range": the speed range where an AVAS shall emit sound (AVAS sound) to fulfil the requirements of this Regulation.
- 2.12. "Lowest frequency of interest": the frequency below which there is no signal content relevant to the measurement of sound emission for the vehicle under test.
- 2.13. Symbols and abbreviated terms and the paragraph in which they are first used.

Table 1
Symbols and Abbreviations

Symbol	Unit	Paragraph	Explanation
Method (A)			Test of the complete vehicle in motion on an outdoor test track , limit values of paragraph. 6.2.8. means the whole vehicle sound
Method (B)			Test of the complete vehicle without movement in standstill condition on an outdoor test track with simulation of the vehicle movement to the AVAS by an external signal generator; limit values of paragraph 6.2.8. means AVAS sound
Method (C)			Test of the complete vehicle without movement with turning wheels in an indoor facility on a chassis dynamometer; limit values of paragraph. 6.2.8. means the whole vehicle sound
Method (D)			Test of the complete vehicle without movement in an indoor facility with simulation of the vehicle movement to the AVAS by an external signal generator; limit values of paragraph 6.2.8. means AVAS sound
ICE	-	6.2.	Internal Combustion Engine
AA'	-	Annex 3 para.3.	Line perpendicular to vehicle travel which indicates the beginning of the zone to record sound pressure level during test
BB'	-	Annex 3 para.3.	Line perpendicular to vehicle travel which indicates end of the zone to record sound pressure level during test
PP'	-	Annex 3 para.3.	Line perpendicular to vehicle travel which indicates location of microphones
CC'	-	Annex 3 para.3	Centreline of vehicle travel

<i>Symbol</i>	<i>Unit</i>	<i>Paragraph</i>	<i>Explanation</i>
v_{test}	km/h	Annex 3 para.3.	Target vehicle test velocity
i	—	3.1.	Index for left or right microphone locations
j	-	Annex 3 para.3.	Index for single test run within standstill or constant speed test conditions
$L_{reverse}$	dB(A)	Annex 3 para.3.	Vehicle A-weighted sound pressure level for reversing test
$L_{crs,10}$	dB(A)	Annex 3 para.3.	Vehicle A-weighted sound pressure level for constant speed test at 10 km/h.
$L_{crs,20}$	dB(A)	Annex 3 para.3.	Vehicle A-weighted sound pressure level for constant speed test at 20 km/h.
$L_{test,j}$	dB(A)	Annex 3 para.2.3.2.	A-weighted sound pressure level result of j^{th} test run
L_{bgn}	dB(A)	Annex 3 para.2.3.1.	Background A-weighted sound pressure level.
L_{bgn_BAND}	dB(A)	Annex 3 paragraph 2.3.1.	Background noise one-third octave A-weighted sound pressure level.
v_{ref}	km/h	Annex 3 para.4.	Reference vehicle velocity used for calculating frequency shift percentage.
$f_{j, speed}$	Hz	Annex 3 para.4.	Single frequency component at a given vehicle speed per sample segment, e.g. $f_1, 5$
f_{ref}	Hz	Annex 3 para.4.	Single frequency component at reference vehicle speed
f_{speed}	Hz	Annex 3 para.4.	Single frequency component at a given vehicle speed, e.g. f_5
l_{veh}	m	Annex 3, Appendix	Length of vehicle
MicLeft $_i$	—	Annex 3 para. 3.1.	i th Microphone situated at left side of vehicle
MicRight $_i$	— —	Annex 3 para. 3.1. 7.1.1	i th Microphone situated at right side of vehicle
MicLeft $_1$	—	Annex 3 para. 3.1.	Microphone situated at left side of vehicle, with height of 0,8 m above ground
MicLeft $_2$	—	Annex 3 para. 3.1.	Microphone situated at left side of vehicle, with height of 1,0 m above ground
MicLeft $_3$	—	Annex 3 para. 3.1	Microphone situated at left side of vehicle, with height of 1,2 m above ground
MicLeft $_4$	—	Annex 3 para. 3.1.	Microphone situated at left side of vehicle, with height of 1,4 m above ground
MicLeft $_5$	—	Annex 3 para. 3.1.	Microphone situated at left side of vehicle, with height of 1,6 m above ground
MicRight $_1$	—	Annex 3 para. 3.1.	Microphone situated at right side of vehicle, with height of 0,8 m above ground
MicRight $_2$	—	Annex 3 para. 3.1.	Microphone situated at right side of vehicle, with height of 1,0 m above ground
MicRight $_3$	—	Annex 3 para. 3.1.	Microphone situated at right side of vehicle, with height of 1,2 m above ground
MicRight $_4$	—	Annex 3 para. 3.1.	Microphone situated at right side of vehicle, with height of 1,4 m above ground

<i>Symbol</i>	<i>Unit</i>	<i>Paragraph</i>	<i>Explanation</i>
MicRight ₅	—	Annex 3 para. 3.1.	Microphone situated at right side of vehicle, with height of 1,6 m above ground
$L_{\text{MicLeft}_i\text{OA}, j}$	dB(A)	Annex 3 para. 3.4.1.	Maximum overall sound pressure level result over the entire measurement interval for each MicLeft _{<i>i</i>} location for the <i>j</i> th measurement run
$L_{\text{MicRight}_i\text{OA}, j}$	dB(A)	Annex 3 para. 3.4.1.	Maximum overall sound pressure level result over the entire measurement interval for each MicRight _{<i>i</i>} location for the <i>j</i> th measurement run
$L_{\text{MicLeftOA}, j}$	dB(A)	Annex 3 para. 3.4.1.	Maximum overall sound pressure level result over the entire measurement interval for all MicLeft _{<i>i</i>} locations for the <i>j</i> th measurement run
$L_{\text{MicRightOA}, j}$	dB(A)	Annex 3 para. 3.4.1.	Maximum overall sound pressure level result over the entire measurement interval for all MicRight _{<i>i</i>} locations for the <i>j</i> th measurement run
$L_{\text{MicLeftOA}}$	dB(A)	Annex 3 para. 3.5.2.	Maximum overall sound pressure level result over the entire measurement interval for all MicLeft _{<i>i</i>} locations
$L_{\text{MicRightOA}}$	dB(A)	Annex 3 para. 3.5.2.	Maximum overall sound pressure level result over the entire measurement interval for all MicRight _{<i>i</i>} locations
$L_{\text{MicLeft}_i\text{BAND}, j}$	dB(A)	Annex 3 para. 3.4.1.	Maximum one-third-octave sound pressure level result for each band over the entire measurement interval for each MicLeft _{<i>i</i>} location for the <i>j</i> th measurement run
$L_{\text{MicRight}_i\text{BAND}, j}$	dB(A)	Annex 3 para. 3.4.1.	Maximum one-third-octave sound pressure level result for each band over the entire measurement interval for each MicRight _{<i>i</i>} location for the <i>j</i> th measurement run
$L_{\text{MicLeftBAND}, j}$	dB(A)	Annex 3 para. 3.5.1.	Maximum one-third octave results for each band over the entire measurement interval for all MicLeft _{<i>i</i>} locations for the <i>j</i> th measurement run
$L_{\text{MicRightBAND}, j}$	dB(A)	Annex 3 para. 3.5.1.	Maximum one-third octave results for each band over the entire measurement interval for all MicRight _{<i>i</i>} locations for the <i>j</i> th measurement run
$L_{\text{MicLeftBAND}}$	dB(A)	Annex 3 para. 3.5.3.	Maximum one-third octave sound pressure level over the entire measurement interval for all MicLeft _{<i>i</i>} locations averaged over all <i>j</i> measurement runs
$L_{\text{MicRightBAND}}$	dB(A)	Annex 3 para. 3.5.3.	Maximum one-third octave sound pressure level over the entire measurement interval for all MicRight _{<i>i</i>} locations averaged over all <i>j</i> measurement runs

3. Application for approval

- 3.1. The application for approval of a vehicle type with regard to reduced audibility shall be submitted by its manufacturer or by a duly accredited representative.
- 3.2. It shall be accompanied by the undermentioned documents and the following particulars:
 - 3.2.1. A description of the vehicle type with regard to the items mentioned in paragraph 2.4. above;
 - 3.2.2. A description of the engine(s) as mentioned in Annex 1, Addendum;
 - 3.2.3. If applicable, a list of the components constituting the AVAS;
 - 3.2.4. If applicable, a drawing of the assembled AVAS and an indication of its position on the vehicle.

- 3.3. In the case of paragraph 2.4., the single vehicle, representative of the type in question, will be selected by the Technical Service conducting approval tests, in agreement with the vehicle manufacturer.
- 3.4. The Type Approval Authority shall verify the existence of satisfactory arrangements for ensuring effective control of the conformity of production before type approval is granted.

4. Markings

- 4.1. The components of the AVAS (if applicable) shall bear:
 - 4.1.1. The trade name or mark of the manufacturer(s) of the AVAS components;
 - 4.1.2. A designated identification number(s).
- 4.2. These markings shall be clearly legible and be indelible.

5. Approval

- 5.1. Type approval shall only be granted if the vehicle type meets the requirements of paragraphs 6. and 7. below.
 - 5.1.1. In case of hybrid vehicles, equipped with an internal combustion engine: If the manufacturer can demonstrate to the Type Approval Authority that the vehicle cannot be assessed according to the provisions of the regulation because the internal combustion engine used for direct propulsion will be operational during the specified tests within this regulation, this regulation shall be deemed not to be applicable to this vehicle.
- 5.2. An approval number shall be assigned to each type approved. Its first two digits (at present 2 corresponding to the 2 series of amendments) shall indicate the series of amendments incorporating the most recent major technical amendments made to the Regulation at the time of issue of the approval. The same Contracting Party shall not assign the same number to another vehicle type.
- 5.3. Notice of approval or of extension or of refusal or withdrawal of approval or of production definitively discontinued of a vehicle type pursuant to this Regulation shall be communicated to the Parties to the Agreement applying this Regulation by means of a form conforming to the model in Annex 1 to this Regulation.
- 5.4. There shall be affixed to every vehicle conforming to a vehicle type approved under this Regulation, conspicuously and in a readily accessible place specified on the approval form, an international approval mark consisting of:
 - 5.4.1. A circle surrounding the letter "E" followed by the distinguishing number of the country which has granted approval;
 - 5.4.2. The number of this Regulation, followed by the letter "R", a dash and the approval number to the right of the circle prescribed in paragraph 5.4.1.
- 5.5. If the vehicle conforms to a vehicle type approved, under one or more other Regulations annexed to the Agreement, in the country which has granted approval under this Regulation, the symbol prescribed in paragraph 5.4.1. need not be repeated. In such a case the regulation and approval numbers and the additional symbols of all the Regulations under which approval has been granted in the country which has granted approval under this Regulation shall be placed in vertical columns to the right of the symbol prescribed in paragraph 5.4.1.
- 5.6. The approval mark shall be clearly legible and indelible.

- 5.7. The approval mark shall be placed close to or on the vehicle data plate affixed by the manufacturer.
- 5.8. Annex 2 to this Regulation gives examples of arrangements of the approval mark.

6. Specifications

6.1. General specifications

For the purpose of this Regulation, the vehicle shall fulfil the following requirements:

6.2. Acoustics characteristics

The sound emitted by the vehicle type submitted for approval shall be measured by the methods described in Annex 3 to this Regulation.

The specifications of this Regulation are applicable in forward and reverse driving condition for the mandatory speed range of greater than 0 km/h up to and inclusive 20 km/h. Operation of an AVAS is permitted at vehicle speeds outside the mandatory speed range, the maximum sound pressure levels for the AVAS sound specified in this Regulation in Table 2a and Table 2b of paragraph 6.2.8. apply. An AVAS sound is only allowed in forward driving direction of the vehicle in the speed range mentioned in Table 2a and for all speeds in reverse direction.

AVAS characteristics beside the tested vehicle speeds during type approval can be declared either by manufacturer declaration in Annex 4 or by additional tests. These tests shall be agreed between the manufacturer and the type approval authority.

AVAS may be operational independent of the operation of an internal combustion engine inside or outside the mandatory speed range.

If a vehicle that is not equipped with an AVAS fulfils the minimum overall levels as specified in Table 2a below with a margin of +3 dB(A) by its natural sound, the specification for one-third octave bands as specified in paragraph 6.2.8. Table 3 and the frequency shift as specified in paragraph 6.2.3. do not apply.

If a vehicle in scope of UN Regulation No. 165 is equipped with an audible reverse warning system, providing an audible signal that exceeds the minimum overall levels as specified in Table 2b of this regulation, the audible reverse warning signal is deemed to fulfil this regulation in reverse driving, without the sound from an AVAS.

6.2.1. Constant speed tests for forward driving

6.2.1.1.1. The test speeds for approval tests are 10 km/h and 20 km/h. Compliance with other speeds covered by Table 2a of paragraph 6.2.8. shall be given by a manufacturer declaration (Annex 4).

6.2.1.1.2. When tested under the conditions of Annex 3 paragraph 3.3.2., the vehicle shall emit a sound

- (a) That has a minimum overall sound pressure level for the specified speed range - according to Table 2a of paragraph 6.2.8.;
- (b) That has at least two of the one-third octave bands according to Table 3 of paragraph 6.2.8. At least one of these bands shall be below or within the 1,600 Hz one-third octave band;
- (c) With minimum sound pressure levels in the chosen bands for the applicable test speeds according to Table 3 of paragraph 6.2.8.;

- 6.2.1.1.3. If after a vehicle is tested in accordance with Annex 3 paragraph 3.3.2., for ten consecutive times within a series of measurements without recording a valid measurement because the vehicle's internal combustion engine (ICE) remains active or restarts and interferes with the measurements, the vehicle is exempted from this particular test.
- 6.2.2. Reversing test
- 6.2.2.1. When tested under the conditions of Annex 3 paragraph 3.3.3. the vehicle must emit a sound that has a minimum overall sound pressure level according to Table 2b of paragraph 6.2.8. Compliance with other speeds covered by Table 2b of paragraph 6.2.8. shall be given by a manufacturer declaration (Annex 4).
- 6.2.2.1.1. If after a vehicle is tested in accordance with Annex 3, paragraph 3.3.3., for ten consecutive times within a series of measurements without recording a valid measurement because the vehicle's ICE remains active or restarts and interferes with the measurements, the vehicle is exempted from this particular test.
- 6.2.3. Frequency shift to signify acceleration and deceleration
- 6.2.3.1.1. The intention of frequency shift is to acoustically inform road users about the change in vehicle speed.
- 6.2.3.1.2. When tested under the conditions of Annex 3 paragraph 4, at least one tone within the frequency range as specified in paragraph 6.2.8. emitted by the vehicle shall vary proportionally with speed within each individual gear ratio by an average of at least 0.8 % per 1 km/h in the speed range from 5 km/h to 20 km/h inclusive when driving in forward direction. In case more than one frequency is shifted, only one frequency shift needs to fulfil the requirements.
- 6.2.4. Sound of the vehicle in standstill condition
- An AVAS sound in standstill condition shall be in compliance with the specifications outlined in paragraph 6.2.8, Tables 2a and 2b.
- The vehicle may emit an AVAS sound only when it is in standstill condition and the propulsion system is activated and:
- in case of a vehicle with an automatic transmission, the vehicle's gear selector is any gear position other than Park; or
 - in case of a vehicle with a manual transmission, the vehicle's parking brake is released.
- When the vehicle is in standstill condition and the gear selector is in reverse driving position, an AVAS sound is mandatory.
- 6.2.5. Driver selectable AVAS sounds
- The vehicle manufacturer may define alternative sounds which can be selected by the driver; each of these sounds shall be in compliance and approved with the provisions in paragraphs 6.2.1. to 6.2.4.
- The compliance with paragraph 6.2.8., Tables 2a and 2b of non-tested sound modes during type approval in respect to Annex 3, paragraph 3.2.3. shall be confirmed by the manufacturer declaration (Annex 4).
- 6.2.6. AVAS Sound Level Variation
- If fitted, an AVAS may operate at different sound levels either automatically managed by the control unit or manually selected by the driver. Each selected sound level shall be in compliance with the specifications outlined in paragraphs 6.2.1. to 6.2.4. and paragraph 6.2.8.
- The compliance with paragraph 6.2.8., Tables 2a and 2b of non-tested sound modes during type approval in respect to Annex 3, paragraph 3.2.3. shall be confirmed by the manufacturer declaration (Annex 4).

All combinations of AVAS sound level variations and AVAS sound shall fulfil the requirements of paragraph 6.2.8., Table 2a, Table 2b and Table 3.

6.2.7. Pause function

In the mandatory speed range as defined in the second sentence of paragraph 6.2. the AVAS sound shall always be emitted.

Any pause function as defined in paragraph 2.8. shall be allowed only outside the mandatory speed range.

6.2.8. Specifications on minimum and maximum sound level for AVAS sound

When tested under the conditions of Annex 3 paragraph 3.3.2, a vehicle which is equipped with an AVAS shall fulfil the requirements of Table 2a, Table 2b and Table 3.

The sound emission of the vehicle under typical on-road driving conditions, which are different from those under which the type approval test set out in Annex 3 was carried out, shall not deviate from the test result in a significant manner.

In the speed range of Table 2a and Table 2b and when tested under the conditions of Annex 3 paragraph 3.3.2., a vehicle which is equipped with an AVAS, shall not emit an AVAS overall sound level of more than 75 dB(A), if driving in forward direction. This test can be stated by manufacturer declaration.

During measurement in reverse the maximum level requirement in the frontline of the vehicle for forward driving has to be fulfilled in addition. This can be stated by manufacturer declaration.

The sound levels measured and reported shall be mathematically rounded to the nearest integer value.

Table 2a
AVAS Minimum and Maximum Overall Sound Pressure Levels⁴ for Forward Driving (e.g., "D")

Vehicle-Speed <i>v</i> in km/h	Minimum Overall SPL in dB(A)		Maximum Overall SPL in dB(A)	
	Forward Driving (e.g., "D")	Vehicle movement blocked (e.g., Position "P")	Forward Driving	Vehicle movement blocked (e.g., Position "P")
0 Standstill	-	x	69	x
0 < <i>v</i> < 10	45		75	
10	50		75	
10 < <i>v</i> < 20	50		75	
20	56		75	
20 < <i>v</i> ≤ 50	-		75	

⁴ The overall sound pressure level in Tables 2a and 2b is measured at a distance of 2 m, which implies that 75 dB(A) is corresponding to the overall sound pressure level of 66 dB(A) measured at a distance of 7.5 m. The limit value of 66 dB(A) at a distance of 7.5 m is the lowest permitted maximum value in Regulations established under the 1958 Agreement.

Table 2b
AVAS Minimum and Maximum Overall Sound Pressure Levels for Reverse Driving (e.g., "R")

Vehicle-Speed v in km/h	Minimum Overall SPL in dB(A)		Maximum Overall SPL in dB(A)	
	Reverse Driving (e.g., "R")	Vehicle movement blocked (e.g., Position "P")	Reverse Driving	Vehicle movement blocked (e.g., Position "P")
0 Standstill	47	x	69	x
$0 < v < 6$	47		75	
6	47		75	
$6 < v \leq 20$	47		75	

Explanation for Table 2a and Table 2b

##	Tests have to be done during type approval and reported inside the Test Report
##	Compliance with the regulation by manufacturer declaration
-	No required sound pressure level for AVAS sound
x	No AVAS sound allowed

Table 3
1/3rd Octave-Bands Minimum Sound Level Requirements in dB(A)

Frequency in Hz	Constant Speed Test paragraph 3.3.2. (10 km/h)	Constant Speed Test paragraph 3.3.2. (20 km/h)
	1/3 rd Octave Bands	160
200		44
250		43
315		44
400		45
500		45
630		46
800		46
1,000		46
1,250		46
1,600		44
2,000		42
2,500		39
3,150		36
4,000		34
5,000	31	

7. Modification and extension of approval of a vehicle type

- 7.1. Every modification of the vehicle type shall be notified to the Type Approval Authority which approved the vehicle type. The Type Approval Authority may then either:
- 7.1.1. consider that the modifications made are unlikely to have an appreciable adverse effect and that in any case the vehicle still complies with the requirements, or

- 7.1.2. require a further test report from the Technical Service responsible for conducting the tests.
- 7.2. Confirmation or refusal of approval, specifying the alterations shall be communicated by the procedure specified in paragraph 5.3. above to the Parties to the Agreement applying this Regulation.
- 7.3. The Type Approval Authority issuing the extension of approval shall assign a series number for such an extension and inform thereof the other Parties to the 1958 Agreement applying this Regulation by means of a communication form conforming to the model in Annex 1 to this Regulation.

8. Conformity of production

The conformity of production procedures shall comply with those set out in the Agreement, Schedule 1 (E/ECE/324-E/ECE/TRANS/505/Rev.3) with the following requirements:

- 8.1. Vehicles approved according to this Regulation shall be manufactured so as to conform to the type approved and satisfy the requirements set forth in paragraph 6.2. above.
- 8.2. The authority which has granted type approval may at any time verify the conformity control methods applied in each production facility. The normal frequency of these verifications shall be one every two years.

In case of Conformity of Production tests, only tests according to paragraph 6.2. shall be performed.

If the sound level of the vehicle tested pursuant to paragraphs 3.3.2. and 3.3.3. of Annex 3 does not exceed by more than 1 dB(A) the maximum sound pressure level limit value and without a tolerance to the minimum sound pressure level limit value prescribed in paragraph 6.2.8., Tables 2a and 2b of this Regulation,

the vehicle type shall be considered to conform to the requirements of this Regulation.

If Conformity of Production is performed using Method (A) and the original Type Approval was conducted using Methods (B) or (D), an additional 1 dB(A) tolerance is applied only for maximum overall sound pressure level requirements.

9. Penalties for non-conformity of production

- 9.1. The approval granted in respect of a vehicle type pursuant to this Regulation may be withdrawn if the requirements set forth above are not met.
- 9.2. If a Contracting Party to the Agreement applying this Regulation withdraws an approval it has previously granted, it shall forthwith so notify the other Contracting Parties applying this Regulation, by means of a communication form conforming to the model in Annex 1 to this Regulation.

10. Production definitively discontinued

If the holder of the approval completely ceases to manufacture a vehicle type approved in accordance with this Regulation, he shall so inform the authority which granted the approval. Upon receiving the relevant communication that authority shall inform thereof the other Parties to the 1958 Agreement applying this Regulation by means of a communication form conforming to the model in Annex 1 to this Regulation.

11. Transitional provisions

- 11.1. Until 24 September 2028, ISO 10844:2014 may be applied as an alternative to ISO 10844:2021 to check compliance of the test track as described in Annex 3, paragraph 2.1.2. of this Regulation.
- 11.2. As from the official date of entry into force of the 02 series of amendments, no Contracting Party applying this Regulation shall refuse to grant or refuse to accept type approvals under this Regulation as amended by the 02 series of amendments.
- 11.3. As from 1 September 2026, Contracting Parties applying this Regulation shall not be obliged to accept type approvals to this Regulation as amended by the 01 series of amendments, first issued after 1 September 2026.
- 11.4. Until 1 September 2028, Contracting Parties applying this Regulation shall accept type approvals to this Regulation in its 01 series of amendments, first issued before 1 September 2026.
- 11.5. As from 1 September 2028, Contracting Parties applying this Regulation shall not be obliged to accept type approvals to this Regulation in its 01 series of amendments.
- 11.6. Notwithstanding the transitional provisions above, Contracting Parties whose application of this Regulation comes into force after the date of entry into force of the 02 series of amendments are not obliged to accept type approvals which were granted in accordance with this Regulation in its earlier series of amendments and are only obliged to accept type approval granted in accordance with the 02 series of amendments.
- 11.6. Contracting Parties applying this Regulation shall not refuse to grant type approvals, or extensions thereof, under this Regulation in its 01 series of amendments.

12. Names and addresses of Technical Services responsible for conducting approval tests and of Type Approval Authorities

The Contracting Parties to the 1958 Agreement applying this Regulation shall communicate to the United Nations Secretariat the names and addresses of the Technical Services responsible for conducting approval tests and of the Type Approval Authorities which grant approval and to which forms certifying approval or extension or refusal or withdrawal of approval, issued in other countries, are to be sent.

Annex 1

Communication

(maximum format: A4 (210 x 297 mm))



issued by: _____
 Name of administration: _____

concerning:² Approval granted
 Approval extended
 Approval refused
 Approval withdrawn
 Production definitively discontinued

of a vehicle type with regard to its sound emission pursuant to UN Regulation No. 138

Approval No. Extension No.

Section I

- 0.1. Make (trade name of manufacturer):
- 0.2. Vehicle Type:
- 0.3. Means of identification of type if marked on the vehicle:³
- 0.3.1. Location of that marking:
- 0.4. Category of vehicle:⁴
- 0.5. Propulsion principle (PEV/HEV/FCV/FCHV):.....
- 0.6. Company name and address of manufacturer:.....
- 0.7. Names and Address(es) of assembly plant(s):
- 0.8. Name and address of the manufacturer's representative (if any):

Section II

- 1. Additional information (where applicable): See Addendum
- 2. Technical service responsible for carrying out the tests:
- 3. Date of test report:
- 4. Number of test report:
- 5. Remarks (if any): See Addendum
- 6. Place:

¹ Distinguishing number of the country which has granted/extended/refused/withdrawn approval (see approval provisions in the Regulation).
² Delete what does not apply.
³ If the means of identification of type contains characters not relevant to describe the vehicle, types covered by the type-approval certificate such characters shall be represented in the documentation by the symbol: '?' (e.g. ABC??123??).
⁴ As defined in R.E.3.

- 7. Date:
- 8. Signature:
- 9. Reasons for Extensions
Attachments:
Information package
Test report(s)

Addendum to the communication form No ...

Technical Information

- 0. General
 - 0.1. Make (trade name of manufacturer):
 - 0.2. Means of identification of type, if marked on the vehicle:¹
 - 0.2.1. Location of that marking:
 - 0.3. Category of vehicle:²
 - 0.4. Company name and address of manufacturer:
 - 0.5. Name and address of the manufacturer's representative (if any):
 - 0.6. Name(s) and Address(es) of assembly plant(s):
- 1. Additional information
 - 1.1. Power plant
 - 1.1.1. Propulsion principle (PEV/HEV/FCV/FCHV) :
 - 1.1.2. Manufacturer of the engine(s):
 - 1.1.3. Manufacturer's engine code(s):
 - 1.2. Description³ of AVAS (if applicable):
 - 1.2.1. Sound at Stationary (yes/no)
 - 1.2.2. No. of driver selectable sounds (1/2/3/...)
 - 1.2.3. AVAS switch off speed: km/h
- 2. Test results
 - 2.1. Sound level of moving vehicle: dB(A) at 10 km/h
 - 2.2. Sound level of moving vehicle: dB(A) at 20 km/h
 - 2.3. Sound level of moving vehicle: dB(A) at 6km/h in reversing
 - 2.4. Sound level of the vehicle: dB(A) at standstill condition in reverse direction
 - 2.5. Frequency shift: % /km/h
- 3. Remarks

¹ If the means of identification of type contains characters not relevant to describe the vehicle, types covered by the type-approval certificate such characters shall be represented in the documentation by the symbol: '?' (e.g. ABC??123??).

² As defined in R.E.3.

³ The description shall also give information about the fading out characteristic and its speeds.

Technical Information Document⁴

- 0. General
 - 0.1. Make (trade name of manufacturer):
 - 0.2. Type
 - 0.3. Means of identification of type, if marked on the vehicle:⁵
 - 0.3.1. Location of that marking:
 - 0.4. Category of vehicle:⁶
 - 0.5. Company name and address of manufacturer:
 - 0.6. Name and address of the manufacturer's representative (if any):
 - 0.8. Name(s) and Address(es) of assembly plant(s):
- 1. General construction characteristics of the vehicle
 - 1.1. Photographs and/or drawings of a representative vehicle:.....
 - 1.3. Number of axles and wheels:⁷.....
 - 1.3.3. Powered axles (number, position, interconnection):.....
 - 1.6. Position and arrangement of the engine(s):
- 2. Masses and dimensions⁸ (in kg and mm) (Refer to drawing where applicable):
 - 2.4. Range of vehicle dimensions (overall):
 - 2.4.1 For chassis without bodywork:
 - 2.4.1.1. Length:.....
 - 2.4.1.2. Width:
 - 2.4.2. For chassis with bodywork
 - 2.4.2.1. Length:.....
 - 2.4.2.2. Width:
- 2.6. Mass in running order
 - minimum and maximum:.....
- 3. Power plant⁹
 - 3.1. Manufacturer of the engine(s):

⁴ Manufactures may automatically create this Technical Information Document by selecting the relevant items from the commonly agreed matrix. These items will appear in the Technical Information Document under the same numbers as in the matrix. Thus, the numbering of items in the Technical Information Document may not necessarily be continuous.

⁵ If the means of identification of type contains characters not relevant to describe the vehicle, types covered by the type-approval certificate such characters shall be represented in the documentation by the symbol: '?' (e.g. ABC??123??).

⁶ As defined in R.E.3.

⁷ Only for the purpose of defining "off-road vehicles".

⁸ (a) Standard ISO 612: 1978 — Road vehicles — Dimensions of motor vehicles and towed vehicles - terms and definitions.

(b) Where there is one version with a normal cab and another with a sleeper cab, both sets of masses and dimensions are to be stated.

(c) Optional equipment that affects the dimensions of the vehicle shall be specified.

⁹ In the case of a vehicle that can run either on petrol, diesel, etc., or also in combination with another fuel, items shall be repeated. In the case of non-conventional engines and systems, particulars equivalent to those referred here shall be supplied by the manufacturer.

- 3.1.1. Manufacturer's engine code(s) (as marked on the engine(s), or other means of identification):
- 3.3. Electric motor
 - 3.3.1. Type of the electric motor (winding, excitation):
- 3.4. Engine or motor combination:
 - 3.4.4. Electric motor (describe each type of electric motor separately)
 - 3.4.4.1. Make:
 - 3.4.4.2. Type:
 - 3.4.4.3. Maximum power:kW
- 6. Suspension
 - 6.6. Tyre size
 - 6.6.2. Upper and lower limits of rolling radii
 - 6.6.2.1. Axle 1:
 - 6.6.2.2. Axle 2:
 - 6.6.2.3. Axle 3:
 - 6.6.2.4. Axle 4:
- etc.
- 9. Bodywork
 - 9.1. Type of bodywork:
 - 9.2. Materials used and methods of construction:
- 12. Miscellaneous
 - 12.5. Details of materials and components influencing the sound emission of the vehicle (if not covered by other items):
- 17. AVAS (if applicable)
 - 17.1. Type of the AVAS (loudspeaker ...):
 - 17.1.1. Make:
 - 17.1.2. Type:
 - 17.1.3. Geometrical characteristics (internal length and diameter)
 - 17.2. The following documents are annexed to this communication:
 - 17.2.1. drawings of the mountings of the sound emitting device(s),
 - 17.2.2. ... drawings and diagrams giving the mounting positions and characteristics of the parts of the structure on which the devices are fitted.
 - 17.2.3. ... over-all views of the front of the vehicle and of the compartment in which the device is situated and description of the component materials.
- Signed:
- Position in company:
- Date:

Annex 2

Arrangements of the approval mark

Model A
(See paragraph 5.4. of this Regulation)



$a = 8 \text{ mm min.}$

The above approval mark affixed to a vehicle shows that the vehicle type concerned has, with regard to its audibility, been approved in the Netherlands (E 4) pursuant to UN Regulation No. 138 under approval No. 002439.

The first two digits of the approval number indicate that UN Regulation No. 138 already included the 02 series of amendments when the approval was granted.

Model B
(See paragraph 5.5. of this Regulation)

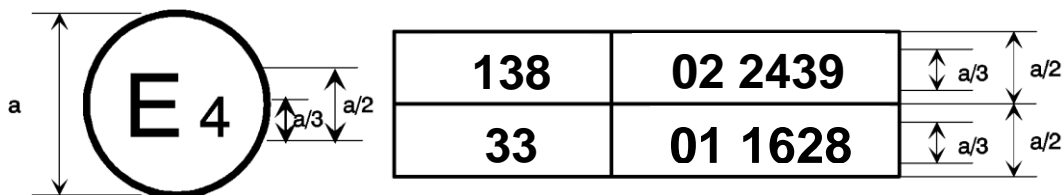

$a = 8 \text{ mm min.}$

The above approval mark affixed to a vehicle shows that the vehicle type concerned has been approved in the Netherlands (E 4) pursuant to UN Regulations Nos. 138 and 33.¹ The approval numbers indicate that, at the dates when the respective approvals were granted, UN Regulation No. 138 included the 02 series of amendments while UN Regulation No. 33 included the 01 series of amendments.

¹ The latter number is given as an example only.

Annex 3

Methods and instruments for measuring the sound made by motor vehicles

1. Instrumentation

1.1. Instruments for acoustic measurement

1.1.1. General

The apparatus used for measuring the sound pressure level shall be a sound level meter or equivalent measurement system meeting the requirements of Class 1 instruments (inclusive of the recommended windscreen, if used). These requirements are described in IEC 61672-1:2013.

The entire measurement system shall be checked by means of a sound calibrator that fulfils the requirements of Class 1 sound calibrators in accordance with IEC 60942-1:2017.

Measurements shall be carried out using the time weighting "F" of the acoustic measurement instrument and the "A" frequency weighting also described in IEC 61672-1:2013. When using a system that includes a periodic monitoring of the A-weighted sound pressure level, a reading should be made at a time interval not greater than 30 ms.

When no general statement or conclusion can be made about conformance of the sound level meter model to the full specifications of IEC 61672-1:2013, the apparatus used for measuring the sound pressure level shall be a sound level meter or equivalent measurement system meeting the conformity requirements of Class 1 instruments as described in IEC 61672-3:2013.

When measurements are carried out for one-third octaves, the instrumentation shall meet all requirements of IEC 61260-1:2014, class 1.

When measurements are carried out for frequency shift, the digital sound recording system shall have at least a 16-bit quantization. The sampling rate and the dynamic range shall be appropriate to the signal of interest.

The instruments shall be maintained and calibrated in accordance with the instructions of the instrument manufacturer.

1.1.2. Calibration

At the beginning of every measurement session, the entire acoustic measurement system shall be checked and adjusted by means of a sound calibrator as described in 1.1.1. At the end of every measurement session, the entire acoustic measurement system shall be checked by means of a sound calibrator as described in 1.1.1.

Without any further adjustment, the difference between the readings at the beginning and the end shall be less than or equal to 0,5 dB. If this value is exceeded, the results of the measurements obtained after the previous satisfactory check shall be discarded.

The checking and adjustment described in 1.1.2 does not invalidate the compliance of IEC 61672-1:2013 described in 1.1.3. for the purpose of this regulation.

A bi-yearly IEC 61672-3:2013 calibration permits the use of a daily sensitivity check and adjustment.

1.1.3. Compliance with requirements

Compliance of the sound calibrator with the requirements of IEC 60942-1:2017 shall be verified once a year. Compliance of the instrumentation system with the requirements of IEC 61672-3:2013 shall be verified at least every 2 years. All compliance testing shall be conducted by a laboratory which is authorized to perform calibrations traceable to the appropriate standards.

1.2. Instrumentation for speed measurements

The road speed of the vehicle shall be measured with instruments meeting specification limits of at least $\pm 0,5$ km/h when using continuous measuring devices.

1.3. Meteorological instrumentation

The meteorological instrumentation used to monitor the environmental conditions during the test shall meet the specifications of:

- (a) ± 1 °C or less for a temperature measuring device;
- (b) $\pm 1,0$ m/s for a wind speed-measuring device;
- (c) ± 5 hPa for a barometric pressure measuring device;
- (d) ± 5 % for a relative humidity measuring device.

2. Acoustic environment, meteorological conditions, and background noise

2.1. Test site

2.1.1. General

The specifications for the test site provide the necessary acoustic environment to carry out the vehicle tests documented in this regulation. Outdoor and indoor test environments that meet the specifications of this regulation provide equivalent acoustic environments and produce results that are equally valid.

2.1.2. Outdoor testing

For the measurement of vehicles in motion, the test track construction and surface shall meet the requirements of ISO 10844:2021.

For the measurement of vehicles at a standstill, the test area shall be either:

- (a) ISO 10844:2014 or ISO 10844:2021; or
- (b) Other dense asphalt; or
- (c) Dense concrete.

The test site shall be substantially level.

Within a radius of 50 m around the centre of the track, the space shall be free of large reflecting objects such as fences, rocks, bridges or buildings. The test track and the surface of the site shall be dry and free from absorbing materials such as powdery snow, or loose debris.

In the vicinity of the microphones, there shall be no obstacle that could influence the acoustic field and no person shall remain between the microphone and the noise source. The meter observer shall be positioned so as not to influence the meter reading. Microphones shall be located as specified in Figures 1 of the Appendix to this annex.

2.1.3. Indoor hemi anechoic or anechoic testing

This paragraph specifies conditions applicable when testing a vehicle, either operating as it would on the road with all systems operational, or operating in a mode where only the AVAS is operational.

The test facility shall meet requirements of ISO 26101:2012 2021 with the following qualification criteria and measurement requirements appropriate to this test method.

Space to be deemed hemi-anechoic shall be defined as shown in Figure 3 of the Appendix to this annex.

For qualifying the hemi acoustic space, the following evaluation shall be conducted:

- (a) Sound source location shall be place on the floor in middle of the space deemed to be anechoic;
- (b) Sound source shall provide a broadband input for measurement;
- (c) Evaluation shall be conducted in one-third-octave bands;
- (d) Microphone locations for evaluation shall be on a line from the source location to each position of microphones used for measurement in this Regulation as shown in Figure 3 of the Appendix to this annex. This is commonly referred to as the microphone transverse;
- (e) A minimum of 10 points shall be used for evaluation on the microphone transverse line;
- (f) The one third octave bands used to establish hemi-anechoic qualification shall be defined to cover the spectral range of interest.

The test facility shall have a cut-off frequency, as defined in ISO 26101:2012, lower than the lowest frequency of interest. The lowest frequency of interest is the frequency below which there is no signal content relevant to the measurement of sound emission for the vehicle under test.

In the vicinity of the microphones, there shall be no obstacle that could influence the acoustic field and no person shall remain between the microphone and the noise source. The meter observer shall be positioned so as not to influence the meter reading. Microphones shall be located as specified in Figures 2 of the Appendix to this annex.

2.2. Meteorological conditions

2.2.1. For outdoor facilities

Metrological conditions are specified to provide a range of normal operating temperatures and to prevent abnormal readings due to extreme environmental conditions.

The meteorological instrumentation shall deliver data representative for the test site and shall be positioned adjacent to the test area at a height representative of the height of the measuring microphone.

A value representative of temperature, relative humidity, and barometric pressure shall be recorded during the measurement interval.

The measurements shall be made when the ambient air temperature is within the range from 5 °C to 40 °C.

The ambient temperature may of necessity be restricted to a narrower temperature range such that all key vehicle functionalities that can reduce vehicle noise emissions (e.g. start/stop, hybrid propulsion, battery propulsion, fuel-cell stack operation) are enabled according to manufacturer's specifications.

The tests shall not be carried out if the wind speed, including gusts, at microphone height exceeds 5 m/s, during the measurement interval.

2.2.2 For indoor facilities

Meteorological conditions are specified to provide a range of normal operating temperatures and to prevent abnormal readings due to extreme environmental conditions.

The meteorological instrumentation shall deliver data representative for the

test site and values of temperature, relative humidity, and barometric pressure shall be recorded during the measurement interval.

The measurements shall be made when the ambient air temperature is within the range from 5 °C to 40 °C.

The ambient temperature may of necessity be restricted to a narrower temperature range such that all key vehicle functionalities that can reduce vehicle noise emissions (e.g. start/stop, hybrid propulsion, battery propulsion, fuel-cell stack operation) are enabled according to manufacturer's specifications.

2.3. Background noise

2.3.1. Measurement criteria for A-weighted sound pressure level

The background, or ambient noise, shall be measured for a duration of at least 10 seconds. A 10 second sample taken from these measurements shall be used to calculate the reported background noise, ensuring the 10 seconds sample selected is representative of the background noise in absence of any transient disturbance. The measurements shall be made with the same microphones and microphone locations used during the test.

When testing in an indoor facility, the noise emitted by the roller-bench, chassis dynamometer or other test facility equipment, without the vehicle installed or present, inclusive of the noise caused by air handling of the facility and vehicle cooling, shall be reported as the background noise.

The overall sound pressure level of the background shall be reported as the largest overall sound pressure level from all microphones, L_{bgn} .

The one-third octave sound pressure level of the background shall be reported as the maximum one-third octave sound pressure level from all microphones in each individual one-third octave band, L_{bgn_BAND} .

Report one-third octave bands as specified in paragraph 6.2.8., Table 3.

As an aid for measurement and reporting of background noises see flowchart in Figure 4 of the Appendix to this annex.

2.3.2. Vehicle A-weighted sound pressure level background noise requirements

The A-weighted overall sound pressure level of the background noise shall be at least 6 dB below the measurement of the vehicle or AVAS subjected to testing.

If a sound peak obviously out of character with the general sound pressure level is observed, that measurement shall be discarded.

2.3.3. Background noise requirements when analyzing in one-third-octave bands

When analyzing one-third octaves according to this regulation, the level of background noise in each one-third octave of interest, analyzed according to paragraph 2.3.1, shall be at least 6 dB below the measurement of the vehicle or AVAS under test in each one-third-octave band of interest.

As an aid for background noise requirements when analyzing in one-third-octave bands see flowchart in Figure 5 of the Appendix to this annex.

3. Test procedures for vehicle sound level

3.1. Microphone positions

The distance from the microphone positions on the microphone line PP' to the perpendicular reference line CC' as specified in Figure 1 and 2 of the Appendix to this annex on the test track or in an indoor test facility shall be $2,0\text{ m} \pm 0,05\text{ m}$.

The microphones shall be located $1,2\text{ m} \pm 0,02\text{ m}$ above the ground level. In

case of a 5 microphone array, the microphones shall be located $1,6 \text{ m} \pm 0,02 \text{ m}$, $1,4 \text{ m} \pm 0,02 \text{ m}$, $1,2 \text{ m} \pm 0,02 \text{ m}$, $1,0 \text{ m} \pm 0,02 \text{ m}$, $0,8 \text{ m} \pm 0,02 \text{ m}$ above the ground level. The reference direction for free field conditions as specified in IEC 61672-1:2013 shall be horizontal and directed perpendicularly towards the path of the vehicle line CC'. Table 1 provides definitions of MicLeft_i and MicRight_i.

In case of measurement Method (B), (C) and (D) the microphones have to be located on the front and rear plane of the vehicle (see Figure 2a and 2b).

3.2. Conditions of the vehicle

3.2.1. General conditions

The vehicle shall be representative of vehicles to be put on the market as specified by the manufacturer in agreement with the technical service to fulfil the requirements of this Regulation.

Measurements shall be made without any trailer, except in the case of non-separable vehicles.

In the case of HEVs/FCHVs, the test shall be carried out in the most energy efficient mode so to avoid the restart of the ICE, e.g. all audio-, entertainment-, communication- and navigation-systems shall be switched off.

Before the measurements are started, the vehicle shall be brought to its normal operating conditions.

3.2.2. Battery state of charge

If so equipped, propulsion batteries shall have a state-of-charge sufficiently high to enable all key functionalities according to the manufacturer's specifications. Propulsion batteries shall be within their component-temperature window to enable all key functionalities that could reduce vehicle sound emissions. Any other type of rechargeable energy storage system shall be ready to operate during the test.

3.2.3. Multi-mode operation

If the vehicle is equipped with multiple driver selectable operating modes, the mode which provides the lowest sound emission during the test conditions of paragraph 3.3. shall be selected. The lowest sound emission shall include both the overall sound pressure level and the minimum of all one-third octave bands of interest.

When the vehicle provides multiple operating modes that are automatically selected by the vehicle, it is the responsibility of the manufacturer to determine the correct manner of testing to achieve the minimum sound emission.

In cases where it is not possible to determine the vehicle operating mode providing the lowest sound emission, all modes shall be tested and the mode giving the lowest test result shall be used to report the vehicle sound emission in accordance with this regulation.

Determination of lowest sound emission will likely require testing of all operating modes to confirm that the one-third octave spectra is the lowest for each and every band of interest at both left and right microphone locations.

3.2.4. Test mass of vehicle

Measurements shall be made on vehicles at mass in running order with an allowable tolerance of +/- 25 %.

3.2.5. Tyre selection and condition

The tyres fitted to the vehicle during testing are selected by the vehicle manufacturer, and shall correspond to one of the tyre sizes and types designated for the vehicle by the vehicle manufacturer.

The tyres shall be inflated to the pressure recommended by the vehicle manufacturer for the test mass of the vehicle.

3.3. Operating conditions

3.3.1. General

For each operating condition, the vehicle can be tested either indoor or outdoor.

For constant speed and reversing tests the vehicle may be tested either in motion or in simulated operating condition. For simulated vehicle operation, signals shall be applied to the vehicle to simulate actual in-use operation.

If the vehicle is equipped with an internal combustion engine, it shall be turned off.

3.3.2. Constant speed tests

These tests are conducted with the vehicle in forward motion or with the vehicle speed simulated by an external signal to the AVAS with the vehicle in standstill condition.

3.3.2.1. Constant speed tests in forward motion

Method (A): For a vehicle tested in an outdoor facility, the path of the centreline of the vehicle shall follow line CC' as closely as possible with constant speed v_{test} throughout the entire test. The front plane of the vehicle shall pass from the line AA' at the start of the test and the rear plane of the vehicle shall pass from the line BB' at the end of the test, as shown in Figure 1a of the Appendix to this annex. Any trailer, which is not readily separable from the towing vehicle, shall be ignored when considering the crossing of the line BB'.

Method (C): For a vehicle tested in an indoor facility, shall be located with the front plane of the vehicle on the PP' line as shown in Figure 2a of the Appendix to this annex. The vehicle shall maintain a constant test speed, v_{test} for at least 5 seconds.

For constant speed test condition of 10 km/h, the test speed v_{test} shall be 10 km/h ± 2 km/h. The measured values are valid for the nominal speed of 10 km/h.

For constant speed test condition of 20 km/h, the test speed v_{test} shall be 20 km/h ± 2 km/h. The measured values are valid for the nominal speed of 20 km/h.

For automatic transmission vehicles, the gear selector shall be placed as specified by the manufacturer for normal driving.

For manual transmission vehicles, the gear selector shall be placed in the highest gear which can achieve the target vehicle speed with constant engine speed.

3.3.2.2. Constant speed tests simulated by an external signal to the AVAS with the vehicle in standstill condition

Method (B) or (D): For a vehicle tested in an indoor or outdoor facility, shall be located with the front plane of the vehicle on the PP' line as shown in Figure 2b of the Appendix to this annex. The vehicle shall maintain a constant simulated test speed, v_{test} for at least 5 seconds.

For constant speed test condition of 10 km/h, the simulated test speed v_{test} shall be 10 km/h $+1,0$ km/h.

For constant speed test condition of 20 km/h, the simulated test speed v_{test} shall be 20 km/h $+1,0$ km/h

3.3.3. Reversing tests

The tests related to paragraph 3.3.3.1. and paragraph 3.3.3.2. may be conducted with the vehicle in rearward motion or with the vehicle speed simulated by an external signal to the AVAS or with the vehicle in standstill condition.

3.3.3.1. Reversing test in motion

Method (A): For a vehicle tested in an outdoor facility, the path of the centreline of the vehicle shall follow line CC' as closely as possible with constant speed v_{test} throughout the entire test. The rear plane of the vehicle shall pass from the line AA' at the start of the test and the front plane of the vehicle shall pass from the line BB' at the end of the test, as shown on Figure 1b of the Appendix to this annex. Any trailer, which is not readily separable from the towing vehicle, shall be ignored when considering the crossing of the line BB'.

Method (C): For a vehicle tested in an indoor facility, shall be located with the rear plane of the vehicle on the PP' line as shown in Figure 2b of the Appendix to this annex. The vehicle shall maintain a constant test speed, v_{test} for at least 5 seconds.

For constant speed test condition of 6 km/h, the test speed v_{test} shall be 6 km/h \pm 2 km/h.

For automatic transmission vehicles, the gear selector shall be placed as specified by the manufacturer for normal reverse driving.

For manual transmission vehicles, the gear selector shall be placed in the highest reverse gear which can achieve the target vehicle speed with constant engine speed.

3.3.3.2. Reversing test simulated by an external signal to the AVAS with the vehicle in standstill condition

Method (B) or (D): For a vehicle tested in an indoor or outdoor facility, shall be located with the rear plane of the vehicle on the PP' line as shown in Figure 2b of the Appendix to this annex. The vehicle shall maintain a constant simulated test speed, v_{test} for at least 5 seconds.

For constant test condition of 6 km/h, the simulated test speed v_{test} shall be 6 km/h \pm 0,5 km/h.

3.3.3.3. Reversing test in standstill condition

A vehicle tested in an indoor or outdoor facility, shall be located with the rear plane of the vehicle on the PP' line as shown in Figure 2b of the Appendix to this annex.

The vehicle's gear selection control shall be in the reverse position and the brake released for the test.

3.4. Measurement readings and reported values

At least four measurements for each test condition shall be made on both sides of the vehicle.

The first four valid consecutive measurement results for each test condition, $L_{\text{MicRight_OA}, j}$ and $L_{\text{MicLeft_OA}, j}$, within 2,0 dB(A) per side, allowing for the deletion of non-valid results, shall be used for the calculation of the intermediate or final result.

If a sound peak obviously out of character with the general sound pressure level is observed, that measurement shall be discarded.

For measurement of a vehicle in motion (forward and reversing) outdoor, the maximum A-weighted sound pressure level indicated during each passage of the vehicle between AA' and PP' ($L_{\text{test},j}$) shall be noted for each microphone position, to the first significant digit after the decimal place (for example XX,X).

The reference point for forward conditions is the front plane of the vehicle. The reference point for reverse conditions is the rear plane of the vehicle.

For minimum specifications as given in paragraph 6.2.8, results are reported over the distance covered by the reference point from AA' to PP'.

For maximum specifications as given in 6.2.8, results are reported over the distance covered by the reference point from AA' to PP' plus the vehicle length.

For measurement of a vehicle in motion indoor and in standstill (forward and reversing), the maximum A-weighted sound pressure level indicated during each period of 5 seconds for each microphone position, $L_{\text{test},j}$, shall be noted, to the first significant digit after the decimal place (for example XX,X).

For one-third-octave measurements, the frequency range shall be reported from 160 Hz to 5000 Hz.

3.4.1. Vehicle stationary (Indoors or outdoors)

For each individual test run j and microphone position i , the vehicle A-weighted sound pressure level for each microphone MicLeft_i and MicRight_i shall be measured for a duration of at least 5 s and the maximum value reported as $L_{\text{MicLeft}_i\text{OA}, j}$ and $L_{\text{MicRight}_i\text{OA}, j}$.

For each individual test run j and microphone position i , the one-third-octave frequency spectrum for each microphone MicLeft_i and MicRight_i shall be measured for a duration of at least 5 s and the maximum hold in each individual one-third-octave-band A-weighted sound pressure level shall be reported as $L_{\text{MicLeft}_i\text{BAND}, j}$ and $L_{\text{MicRight}_i\text{BAND}, j}$.

3.4.2. Vehicle in motion measured with Method A

For each individual test run j and microphone position i , the vehicle A-weighted sound pressure level for each microphone MicLeft_i and MicRight_i shall be measured between the AA' and PP' line and the maximum value reported as $L_{\text{MicLeft}_i\text{OA}, j}$ and $L_{\text{MicRight}_i\text{OA}, j}$.

For each individual test run j and microphone position i , the one-third-octave frequency spectrum for each microphone MicLeft_i and MicRight_i shall be measured between the AA' and PP' line. The maximum hold in each individual one-third-octave-band A-weighted sound pressure level shall be reported as $L_{\text{MicLeft}_i\text{BAND}, j}$ and $L_{\text{MicRight}_i\text{BAND}, j}$.

3.5. Data compilation and reported results

For each test condition described in paragraph 3.3., the overall Sound Pressure Level and the corresponding one third octave spectra of both sides of the vehicle individually shall be arithmetically averaged and rounded to the first decimal place.

For the measurements of the opposite side of driving direction at method "B", "C" and "D" additional microphones are necessary (see figure 2a , 2b).

The final A-weighted overall sound pressure level results $L_{\text{crs } 10}$, $L_{\text{crs } 20}$ and L_{reverse} to be reported are the lower values of the two averages of both sides, rounded to the nearest integer. The one third octave band frequency-spectrum, shall be reported for both sides of the vehicle, $L_{\text{MicLeftBAND}}$ and $L_{\text{MicRightBAND}}$.

3.5.1. Intermediate processing when 5 microphone array is used

For each vehicle operating condition, stationary or moving, the five left and right microphone results shall be processed to provide a single left and right result for each measurement run j .

The intermediate processing for each measurement run j and for the five microphone positions i will produce a single result for the overall sound pressure level for the left and right side of the vehicle and a single one-third

octave spectra for the left and right side of the vehicle. All further processing is done using these results.

Figures 6 and 7 in the appendix to Annex A gives measurement criteria for overall sound pressure level and one-third octave band sound pressure levels in flowchart form as an aid to measurement and reporting results.

3.5.1.1. Overall sound pressure level

The value $L_{\text{MicLeft_OA}, j}$ and $L_{\text{MicRight_OA}, j}$ for each test run j shall be the arithmetic average of each of the five microphone positions i .

$$L_{\text{MicLeft_OA}, j} = \left(\sum_{i=1}^5 L_{\text{MicLeft}_i\text{OA}, j} \right) / 5$$

$$L_{\text{MicRight_OA}, j} = \left(\sum_{i=1}^5 L_{\text{MicRight}_i\text{OA}, j} \right) / 5$$

3.5.1.2. One-third octave band sound pressure level

The value $L_{\text{MicLeft_BAND}, j}$ and $L_{\text{MicRight_BAND}, j}$ for each test run j shall be the maximum hold of each of the five microphone positions i in all individual one-third octave bands for each measurement run j

$$L_{\text{MicLeft_BAND}, j} = \max(L_{\text{MicLeft}_i\text{BAND}, j})$$

$$L_{\text{MicRight_BAND}, j} = \max(L_{\text{MicRight}_i\text{BAND}, j})$$

3.5.2. Maximum A-weighted sound pressure level data compilation

For a given test condition and mode, the four j test runs are averaged to determine the intermediate result on each side.

For a given test condition and mode, the runs shall be averaged separately for each side.

Calculate $L_{\text{MicLeftOA}}$

Calculate $L_{\text{MicRightOA}}$

$$L_{\text{MicLeftOA}} = \left(\sum_{i=1}^4 L_{\text{MicLeftOA}, j} \right) / 4$$

$$L_{\text{MicRightOA}} = \left(\sum_{i=1}^4 L_{\text{MicRightOA}, j} \right) / 4$$

Calculate the final reported overall sound pressure level for each condition and mode as the lowest of the left and right side.

$$L_{(\text{condition})} = \min(L_{\text{MicLeftOA}}, L_{\text{MicRightOA}})$$

For each test condition described in paragraph 3.3., the overall Sound Pressure Level both sides of the vehicle individually shall be arithmetically averaged and rounded to the first decimal place.

For the measurements at the frontline of the vehicle according to annex 3 Paragraph 3.3.2. with Method B, C and D additional microphones are necessary and to be rounded to the first decimal place.

3.5.3. One-third-octave sound pressure level data compilation

For a given test condition and mode, the four j test runs are averaged to determine the result on each side.

$$L_{\text{MicLeftBAND}} = \left(\sum_{i=1}^4 L_{\text{MicLeftBAND}, j} \right) / 4$$

$$L_{\text{MicRightBAND}} = \left(\sum_{i=1}^4 L_{\text{MicRightBAND}, j} \right) / 4$$

Any further processing of the one-third-octave-band values shall use these results.

Both the $L_{\text{MicLeftBAND}}$ and the $L_{\text{MicRightBAND}}$ shall be reported.

Report one-third octave bands as specified in paragraph 6.2.8., Table 3.

4. Test procedures for frequency shift

4.1. General

The provisions on frequency shift outlined in 6.2.3 of the main body shall be checked using one of the test methods A, B, C and D to be selected by the manufacturer.

The facility requirements as well as the vehicle and test setup specifications are the same as given in paragraphs 1, 2, 3.1 and 3.2 of this Annex according to the selected test method unless the following paragraphs below provide different or additional specifications.

No background noise correction shall be applied to any measurement. Special care must be given for outdoor measurements. Any interference of the background noise shall be avoided. If a sound peak obviously out of character with the general signal is observed, that measurement shall be discarded.

4.2. Instrumentation and signal processing

Analyser settings shall be agreed between the manufacturer and the technical service to provide data according to these requirements.

The sound analysis system shall be capable of performing spectral analysis at a sampling rate and over a frequency range containing all frequencies of interest. The frequency resolution shall be sufficiently precise to differentiate between the frequencies of the various test conditions.

4.3. Test methods

The vehicle sound emission tests, which are basis for the type approval test shall be The type approval has to be

4.3.1. Method (A)

The vehicle shall be operated in the same outdoor test facility and according to the same general operating condition as for the vehicle constant speed testing (paragraph 3.3.2 and paragraph 3.3.3.).

4.3.2. Method (B) and Method (D)

The vehicle shall be operated in a test facility where the vehicle can accept an external vehicle speed signal to the AVAS simulating vehicle operation. The microphone locations shall be as for the complete vehicle test conditions as specified in Figure 2a of the Appendix to this annex. The front plane of the vehicle shall be placed on line PP'.

4.3.3. Method (C) – Indoor facility and vehicle in motion

The vehicle shall be installed in an indoor test facility where the vehicle can operate on a chassis dynamometer in the same manner as outdoors. All microphone locations shall be as for the vehicle test conditions as specified in Figure 2a of the Appendix to this annex. The front plane of the vehicle shall be placed on line PP'.

4.4. Measurement Readings

4.4.1. Test Method (A)

At least four measurements shall be made at every speed specified in paragraph 4.3.1. The emitted sound shall be recorded during each passage of the vehicle between AA' and BB' for each microphone position.

From each measurement sample a segment taken from AA until 1 meter before PP' shall be used for further analysis.

4.4.2. Test Methods (B), (C) and (D)

The emitted sound shall be measured at every speed specified in correlated paragraphs above for at least 5 seconds.*

4.5. Signal Processing

For each recorded sample the average auto power spectrum shall be determined, using a Hanning window and at least 66.6% overlap averages. The frequency resolution shall be chosen to be sufficiently narrow as to allow a separation of the frequency shift per target condition. The reported speed per sample segment is the average vehicle speed over the time of the sample segment rounded to the first decimal place.

In case of test method (A) the frequency that is intended to be changed with the speed shall be determined per sample segment. The reported frequency per target condition f_{speed} shall be the mathematical average of the frequencies determined per measurement sample and rounded to the nearest integer. The reported speed per target condition shall be the mathematical average of the four sample segments.

Table 4
Analysis of the shifted frequency per target condition per side

<i>Target speed</i>	<i>Test run per target condition</i>	<i>Reported speed (average per sample segment)</i>	<i>Determined frequency of interest ($f_{j, speed}$)</i>	<i>Reported Speed per target condition (average of the reported speeds)</i>	<i>Reported frequency of interest per target condition (f_{speed})</i>
<i>km/h</i>	<i>No</i>	<i>km/h</i>	<i>Hz</i>	<i>km/h</i>	<i>Hz</i>
5*	1				
	2				
	3				
	4				
10	1				
	2				
	3				
	4				
15	1				
	2				
	3				
	4				
20	1				
	2				
	3				
	4				

*) not for Method A

For all other test methods the derived frequency spectrum shall directly be used for the further calculation.

* Note by the secretariat: as an aid for measurement of frequency shift see flowchart in Figure 7a, 7b or 7c of the Appendix to this annex.

4.5.1. Data compilation and reported results

The frequency intended to be shifted shall be used for the further calculation. The frequency of the lowest reported test speed rounded to the nearest integer is taken as the reference frequency f_{ref} .

For the other vehicle speeds, the corresponding shifted frequencies f_{speed} rounded to the nearest integer shall be taken from the spectra analysis. Calculate del_f , the frequency shift of the signal according to equation (1):

$$del_f = \{ [(f_{speed} - f_{ref}) / (v_{test} - v_{ref})] / f_{ref} \} \cdot 100 \quad \text{equation (1)}$$

where

f_{speed} is the frequency at a given speed value;

f_{ref} is the frequency at the reference speed of 5 km/h or the lowest reported speed;

v_{test} is the vehicle speed, actual or simulated, corresponding to the frequency f_{speed} ;

v_{ref} is the vehicle speed, actual or simulated, corresponding to the frequency f_{ref} ;

The results shall be reported using the following table:

Table 5

Report table, to be completed for each frequency analysed

		<i>Test Results at Target Speeds</i>			
		<i>5 km/h*</i> <i>(Reference)</i>	<i>10 km/h</i> <i>(Reference*)</i>	<i>15km/h</i>	<i>20 km/h</i>
Reported Speed	km/h				
Frequency, f_{speed} , Left Side	Hz				
Frequency, f_{speed} , Right Side	Hz				
Frequency Shift, del_f , Left Side	%	n.a.	n.a*		
Frequency Shift, del_f , Right Side	%	n.a.	n.a*		

*) not for Method A

Annex 3 – Appendix

Figures and flowcharts

Figures 1a and 1b
Measuring positions for vehicles in motion outdoor

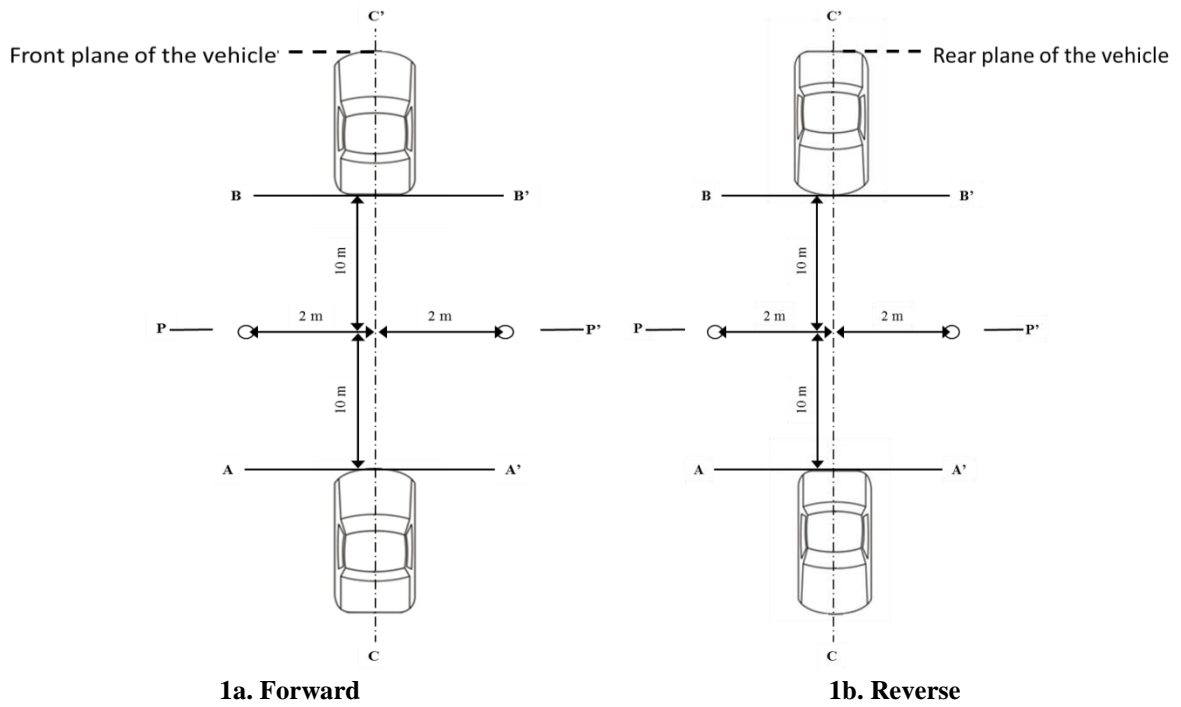

Figures 2a and 2b
Measuring positions for vehicles in motion indoor and in standstill
additional 2 microphones needed at the front and in the back in 2 m distance

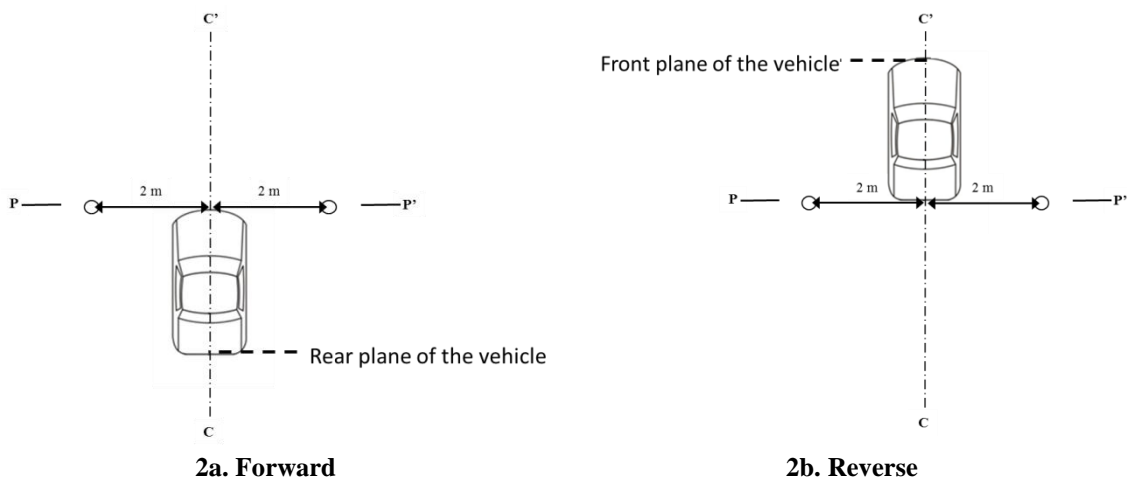

Figure 3
Minimum space to be qualified as Semi-Anechoic chamber

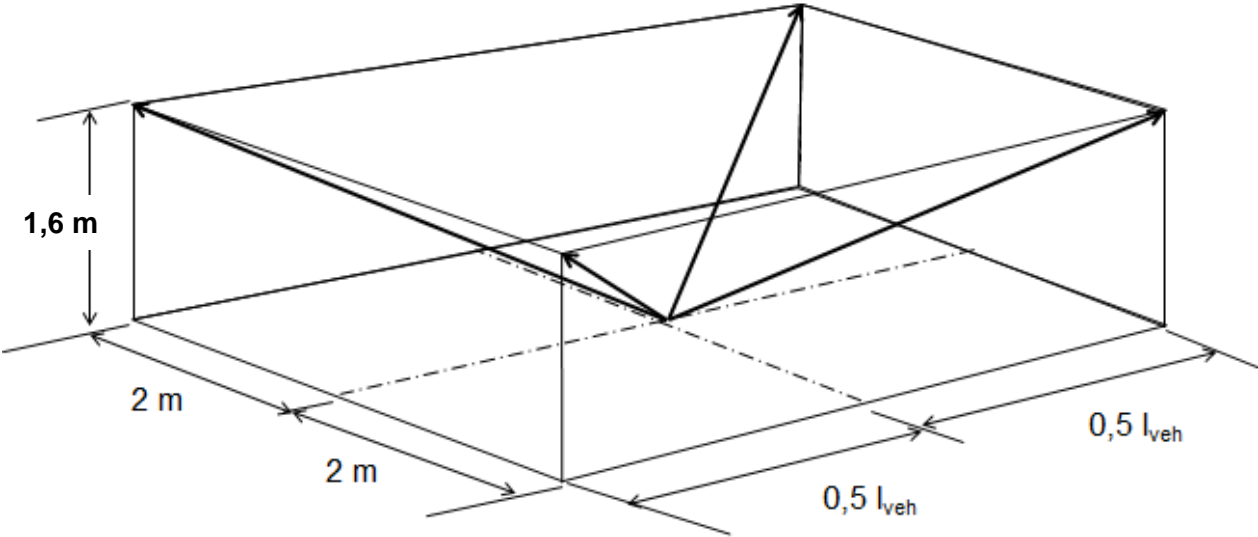

Figure 4
Background Noise Measurement

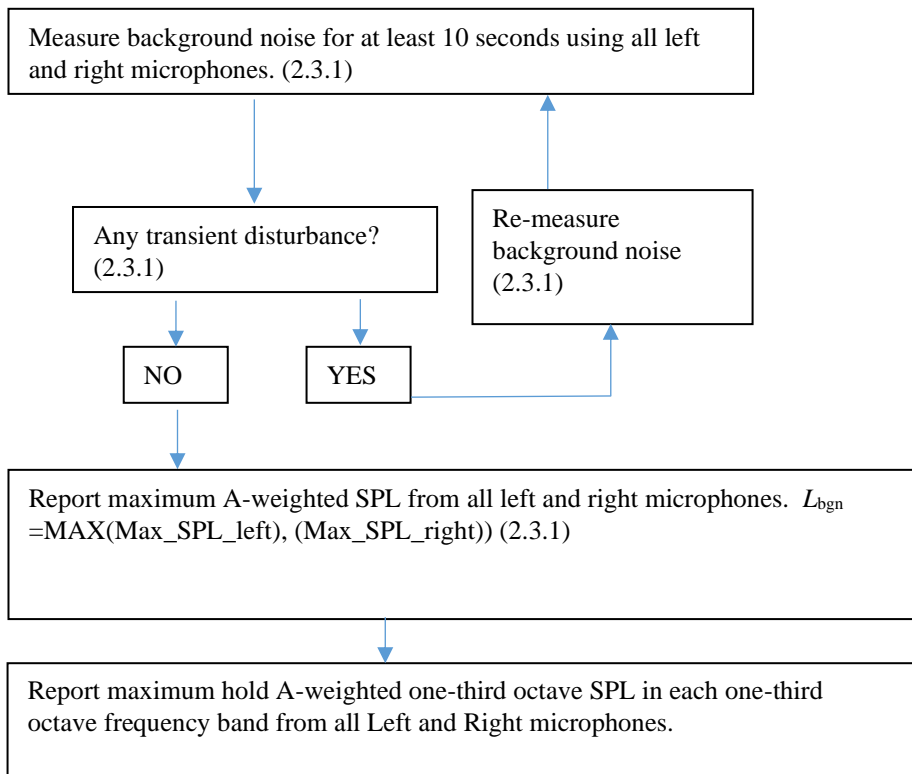

Figure 5
Background noise requirements

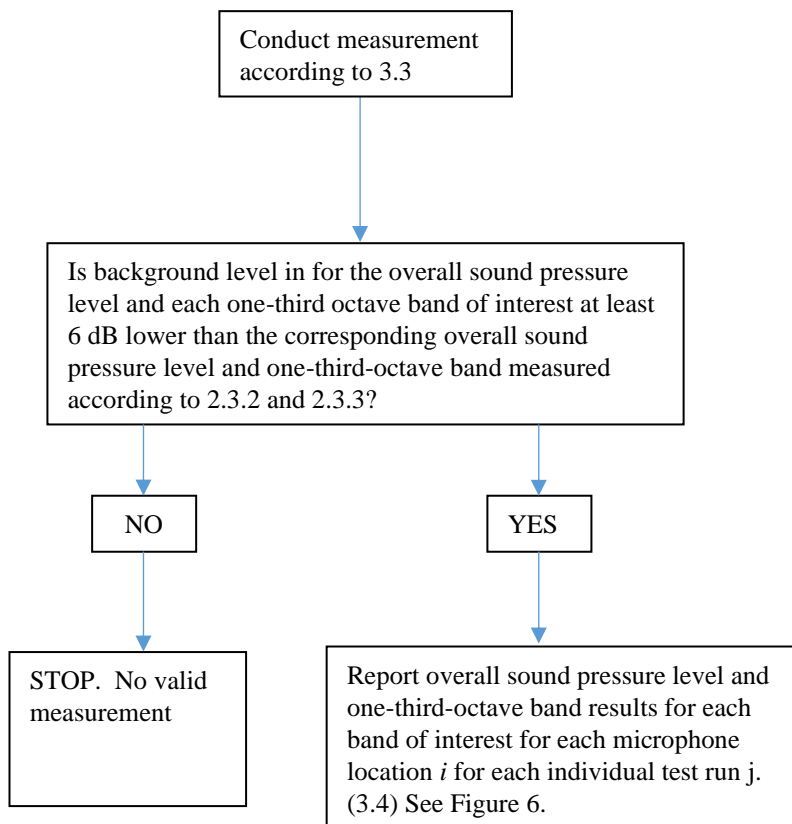
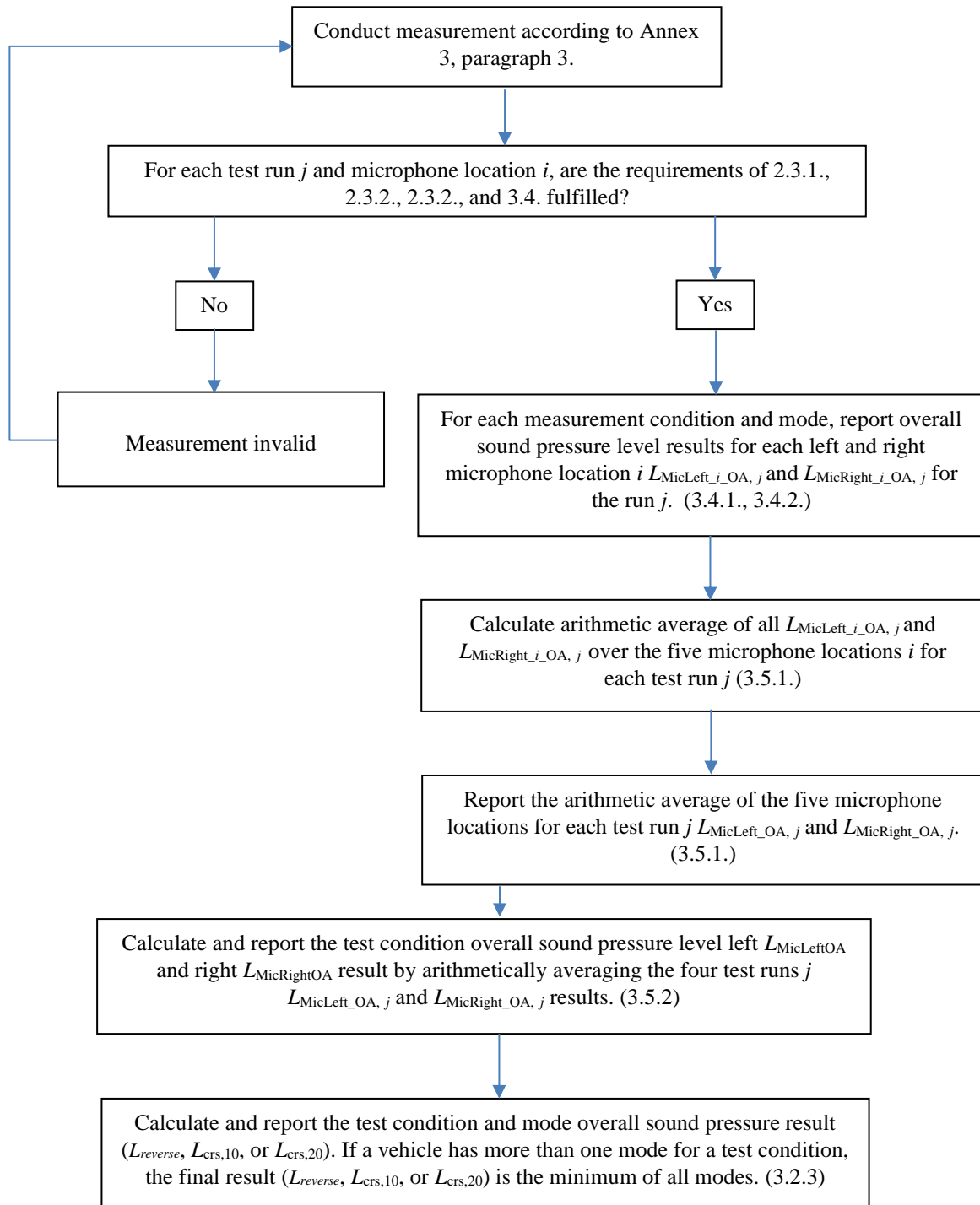

Figure 6.
Flowchart for the procedure to measure and report overall A-weighted sound pressure levels



The purpose of Figure 6 is to show how to go from the five microphone results for each measurement run to a final answer. It conceptually has two major steps:

1. First reduce the five microphones to a single result for each measurement run *j*. In this case, the maximum overall sound pressure level in each microphone *i* is arithmetically averaged to produce the final result.
2. Average the four *j* measurement runs to provide the final answer for the test condition and mode.

Figure 7.

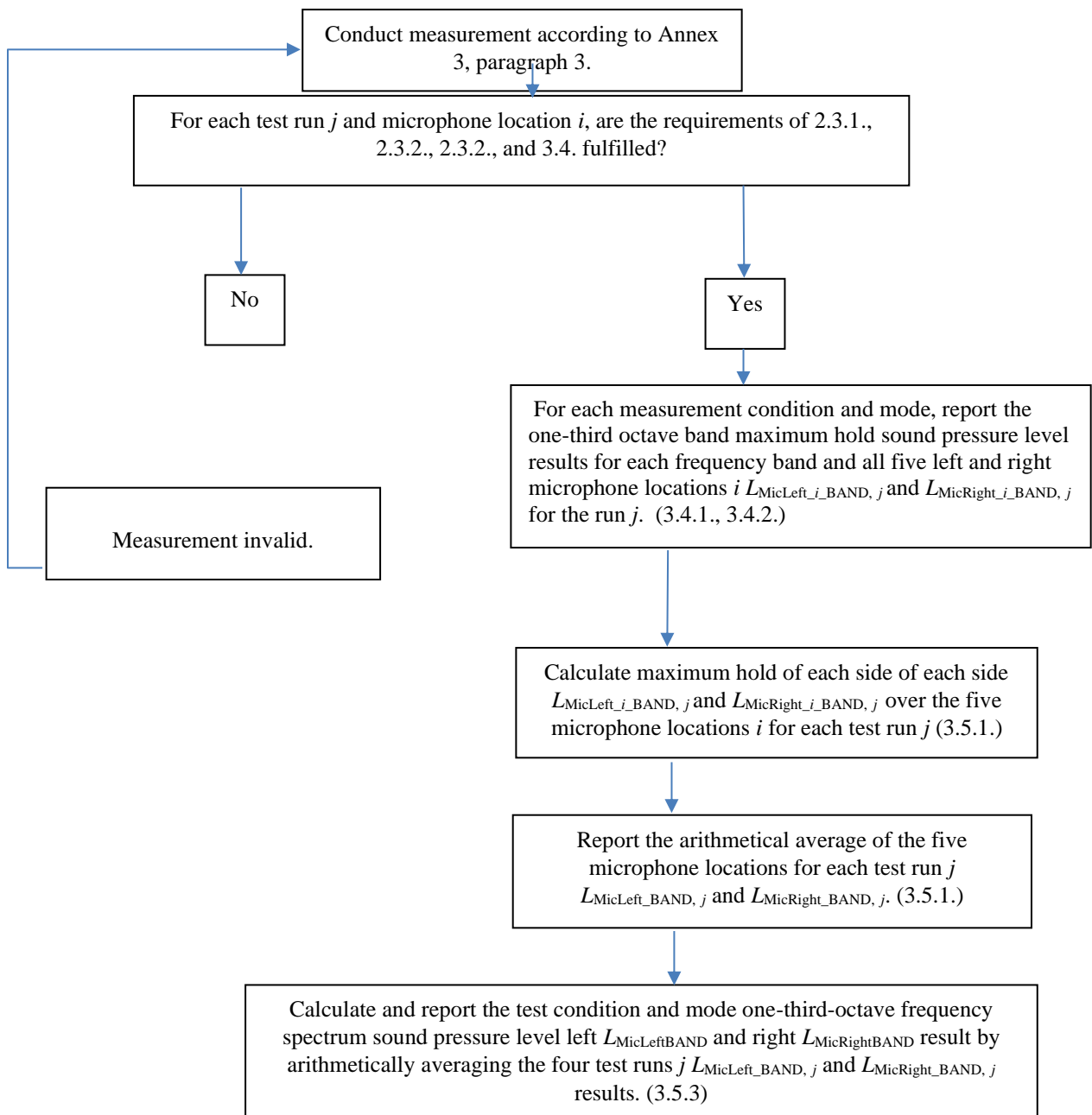
Flowchart for the procedure to measure and report A-weighted one third octave sound pressure levels

The purpose of Figure 7 is to show how to go from the five microphone results for each measurement run to a final answer. It conceptually has two major steps:

1. First reduce the five microphones to a single result for each measurement run j . In this case, the maximum one-third-octave sound pressure level in each frequency in each microphone i is measured. Then these five spectra are again reduced to a single spectrum by taking the maximum one-third-octave sound pressure level in each frequency. The result is then the reported frequency spectrum for a given test run j .
2. Average the four j measurement runs to provide the final answer for the test condition and mode.

Figure 7a
Test procedures for measurement of frequency shift

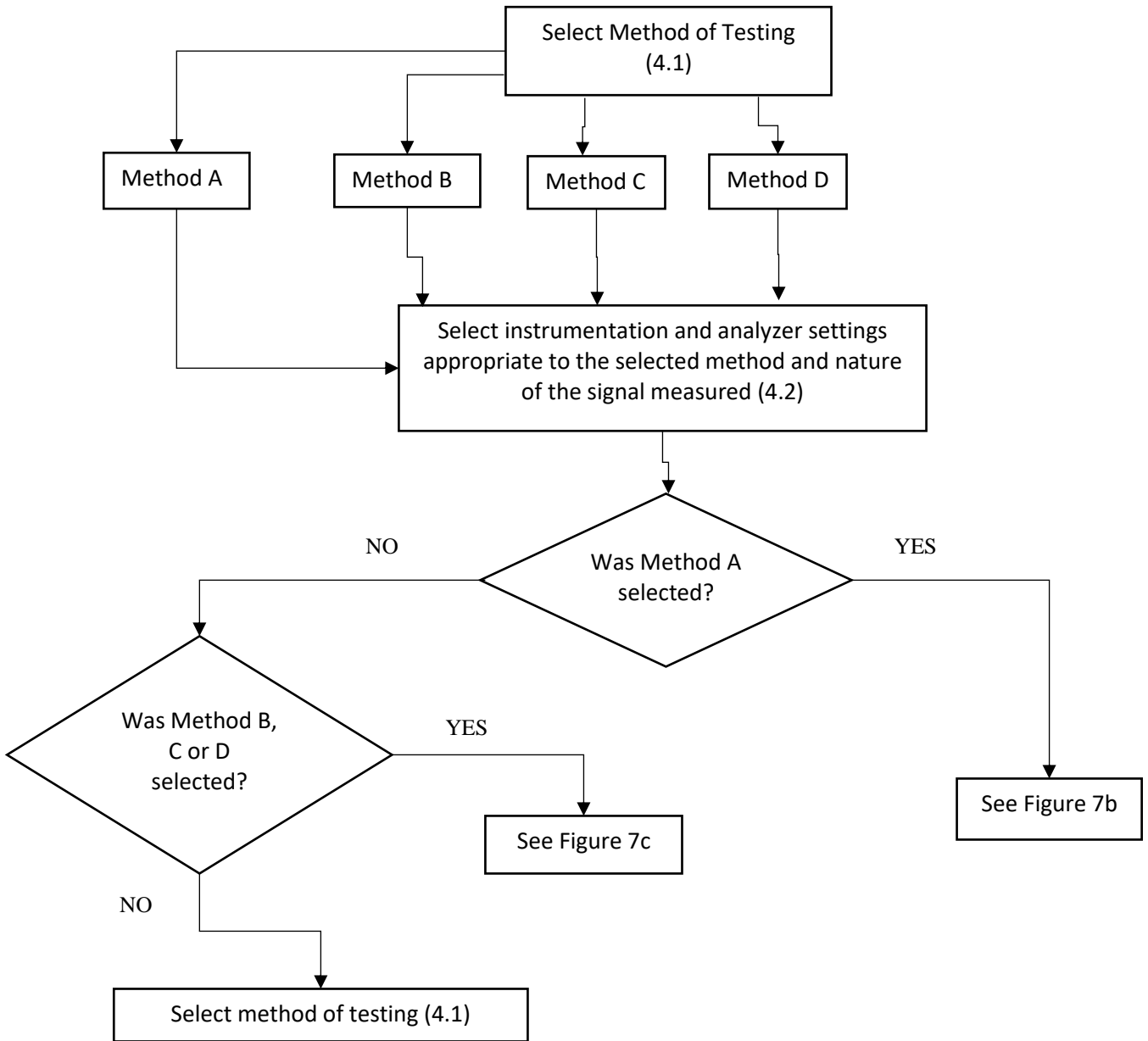
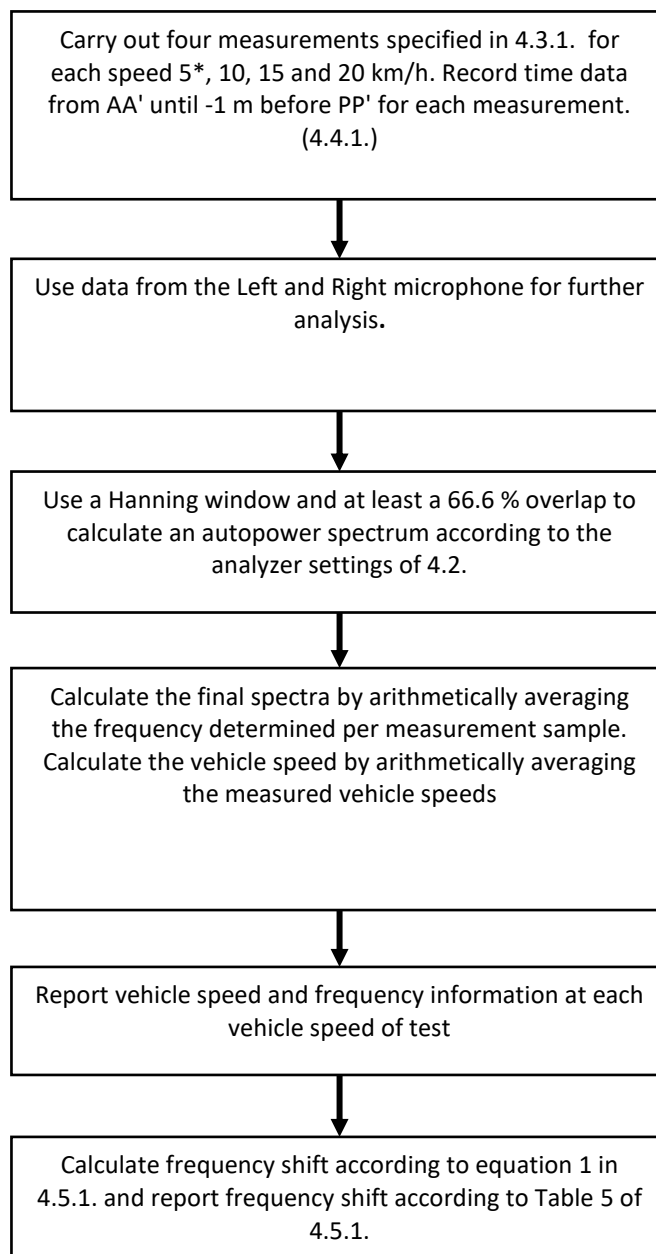
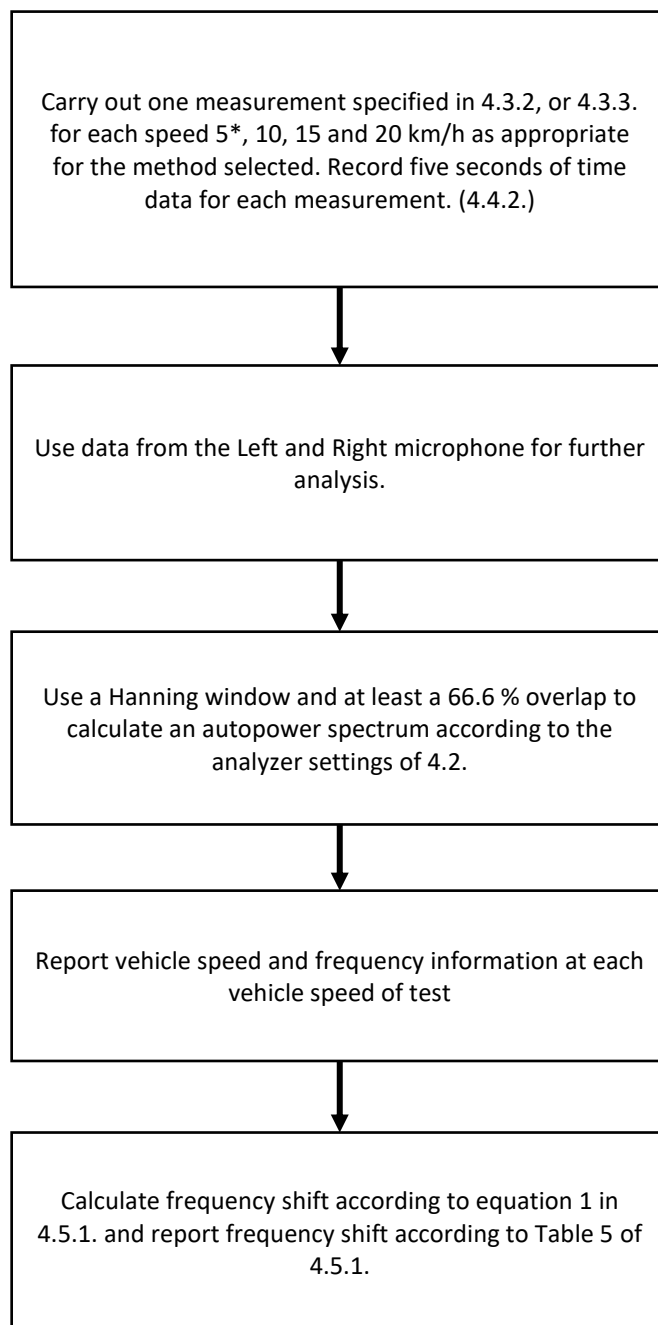

Figure 7b
Test procedures for measurement of frequency shift, Method A



*) not for Method A

Figure 7c
Test procedures for measurement of frequency shift, Methods B, C and D



*) not for Method A

Annex 4

Statement of compliance of Quiet Road Transport Vehicles (QRTV) with regard to their reduced audibility

Even if this statement is declared, the approval authority may ask for additional information about the declaration of compliance and carry out the tests according to the appropriate paragraphs of Annex 3 respectively.

(Maximum format: A4 (210 x 297 mm))

..... (Name of manufacturer) attests that vehicles of this type (type with regard to its sound emission pursuant to UN Regulation No. 138) comply with the requirements of paragraph 6. of UN Regulation No. 138 in all vehicle modes and all selectable driving sounds.

..... (Name of manufacturer) makes this statement in good faith, after having performed parts or vehicles evaluation of the sound emission performance.

Date:

Name of authorized representative:

Signature of authorized representative:
