

Proposal for amendment to ECE/TRANS/WP.29/GRSG/2024/12

(Vulnerable Road Users in Front and Side Close Proximity)

Submitted by the expert from Japan

The text reproduced below was prepared by the experts from Japan to amend UN Regulation No. 166 for avoiding misunderstandings in the certification process. This proposal amends ECE/TRANS/WP.29/GRSG/2024/12. The modifications to the existing Regulation are marked in bold for new or strikethrough for deleted characters. The additional modifications to ECE/TRANS/WP.29/GRSG/2024/12 are marked in **Red**.

I. Proposal

Table of contents, amend to read:

"Contents

Page**

Regulation

0. Introduction

...

Annexes

...

13 Necessity of Pendulum Impact Test..... "

Paragraphs 1.1.1. and 1.1.2., add footnote 1 and amend to read:

"1.1.1. Approval of means of front and lateral vision defined in Part I intended to be fitted to vehicles of category M₁ and N₁.

1.1.2. Approval of vehicle installation of devices of front and lateral vision or detection defined in Part II intended to be fitted to vehicles of category M₁ and N₁.¹

"

Paragraph 1.1.3. amend to read:

"1.1.3. At the request of the manufacturer, Contracting Parties may grant approvals under Parts ~~I and~~ II to vehicles, and to the installation of devices for fitting to such vehicles, of other categories and devices for fitting to such vehicles. "

Paragraph 5.2. amend to read:

** Page numbers will be added at a later stage.

¹ As defined in the Consolidated Resolution on the Construction of Vehicles (R.E.3.), document ECE/TRANS/WP.29/78/Rev.7. -

www.unece.org/trans/main/wp29wgs/wp29gen/wp29resolutions.html

"5.2. ~~An approval number shall be assigned to each type approved. Its first two digits (at present 00) shall indicate the series of amendments incorporating the most recent major technical amendments made to the Regulation at the time of issue of the approval. An approval number shall be assigned to each approved type in accordance with Schedule 4 of the Agreement (E/ECE/TRANS/505/Rev.3). The same Contracting Party shall not assign the same number to another type of device for means of front and lateral vision.~~"

Insert new paragraphs 6.1.3. to 6.1.4., to read:

"6.1.3 Protective housing

6.1.3.1. When the edge of the reflective surface is enclosed in a protective housing, the radius of curvature "c" on the housing's perimeter shall be not less than 2.5 mm at all points and in all directions.

When the edge of the reflecting surface is not enclosed by the protective housing independent from any adjustment position, the radius of curvature "c" on its perimeter shall be not less than 2.5 mm at all points and in all directions and shall apply to the edge of the projecting part.

6.1.3.2. When the mirror is mounted on a plane surface, all parts, irrespective of the adjustment position of the device, including those parts remaining attached to the support after the test provided for in paragraph 6.2.2. below, which are in potential, static contact with a sphere either 165 mm in diameter in the case of interior mirror or 100 mm in diameter in the case of exterior mirror, shall have a radius of curvature "c" of not less than 2.5 mm.

6.1.3.3. The requirements in paragraphs 6.1.3.1. and 6.1.3.2. above shall not apply to parts of the external surface which protrude less than 5 mm, but the outward facing angles of such parts shall be blunted, save where such parts protrude less than 1.5 mm. To determine the dimension of the projection, the following method shall apply:

6.1.3.3.1. The dimension of the projection of a component which is mounted on a convex surface may be determined either directly or by reference to a drawing of an appropriate section of this component in its installed condition.

6.1.3.3.2. If the dimension of the projection of a component which is mounted on a surface other than convex cannot be determined by simple measurement, it shall be determined by the maximum variation of the distance of the centre of a 100 mm diameter sphere from the nominal line of the panel when the sphere is moved over and is in constant contact with that component.

Figure 1 shows an example of the use of this procedure.

**Figure 1
Example for the measurement by maximum variation**

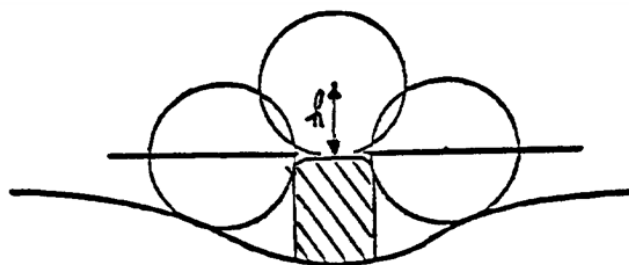

6.1.3.4. Edges of fixing holes or recesses of which the diameter or longest diagonal is less than 12 mm are exempt from the radius requirements of paragraph 6.1.3.2. above, provided that they are blunted.

- 6.1.3.5. The device for the attachment of mirrors to the vehicle shall be so designed that a cylinder with a 70 mm radius, having as its axis the axis, or one of the axes, of pivot or rotation which ensures deflection of the mirror in the direction of impact concerned, passes through at least part of external original surface where the device is protruding from.
- 6.1.3.6. The parts of exterior mirrors referred to in paragraphs 6.1.3.1. and 6.1.3.2. above which are made of a material with a Shore A hardness not exceeding 60 are exempt from the relevant provisions.
- 6.1.3.7. In the case of those parts of interior mirrors which are made of a material with a Shore A hardness of less than 50 and which are mounted on a rigid support, the requirements of paragraphs 6.1.3.1. and 6.1.3.2. above shall only apply to the support.
- 6.1.3.8. The requirements of paragraph 6.1.3.2. do not apply to mirrors, if their lower edge is mounted not less than 2 m above the ground when the vehicle is under a load corresponding to its maximum technical permissible mass.
- 6.1.4. The devices that approved by UN Regulation No.26 or No.61 shall be exempted the requirements of paragraph 6.1.3. of this Regulation."

Insert new paragraphs 6.2. to 6.2.4., to read:

- "6.2. **Test for close-proximity of front and lateral vision mirrors**
The requirements of paragraph 6.2. shall be considered to be satisfied in the case of mirrors of a vehicle fulfilling the provisions of Regulation No. 21.
- 6.2.1. **Devices for mirrors shall be subjected to the tests described in paragraphs 6.2.2.1. and 6.2.2.2. below. Exterior mirrors with a stem, shall be subjected to the tests described in paragraph 6.2.2.3. below.**
- 6.2.1.1. **The test provided for in paragraph 6.2.2. below shall not be required in the case of any exterior device for indirect vision of which no part is less than 2 m from the ground, regardless of the adjustment position, when the vehicle is under a load corresponding to its maximum technically permissible mass.**

This derogation also applies to the attachments of devices for indirect vision (attachment plates, arms, swivel joints, etc.) which are situated less than 2 m from the ground and which do not project beyond the overall width of the vehicle, measured in the transverse plane passing through the lowest device for indirect vision attachments or any other point forward of this plane if this configuration produces a greater overall width.

In such cases, a description specifying that the device for indirect vision shall be mounted so as to conform to the above-mentioned conditions for the positioning of its attachments on the vehicle shall be provided.

Where advantage is taken of this derogation, the arm shall be indelibly marked with the symbol

$$\frac{\Delta}{2m}$$

and the type approval certificate shall be endorsed to this effect.

- 6.2.2. **Impact test**
The test according to this paragraph is not to be carried out for:
 - (a) exterior devices not projecting beyond the overall width and length of the vehicle and providing a frontal deflecting area of an angle not more than 45° measured in relation to the longitudinal median plane of the vehicle; or

- (b) devices not protruding more than 100 mm measured at the attachment point beyond the circumscribing external original surface of the vehicle according to UN Regulation No. 26 (See Annex 13).

6.2.2.1. Description of the test rig

6.2.2.1.1. The test rig consists of a pendulum capable of swinging about two horizontal axes at right angles to each other, one of which is perpendicular to the plane containing the "release" trajectory of the pendulum.

The end of the pendulum comprises a hammer formed by a rigid sphere with a diameter of 165 ± 1 mm and 5 ± 1 mm thick rubber covering of Shore A hardness 50.

A device is provided which permits determination of the maximum angle assumed by the arm in the plane of release.

A support firmly fixed to the structure of the pendulum serves to hold the specimens in compliance with the impact requirements specified in paragraph 6.2.2.2.6. below.

Figure 2 below gives the dimensions (in mm) of the test rig and the special design specifications:

Figure 2
Dimensions of the Test Rig and the Special Design
(in millimeters)

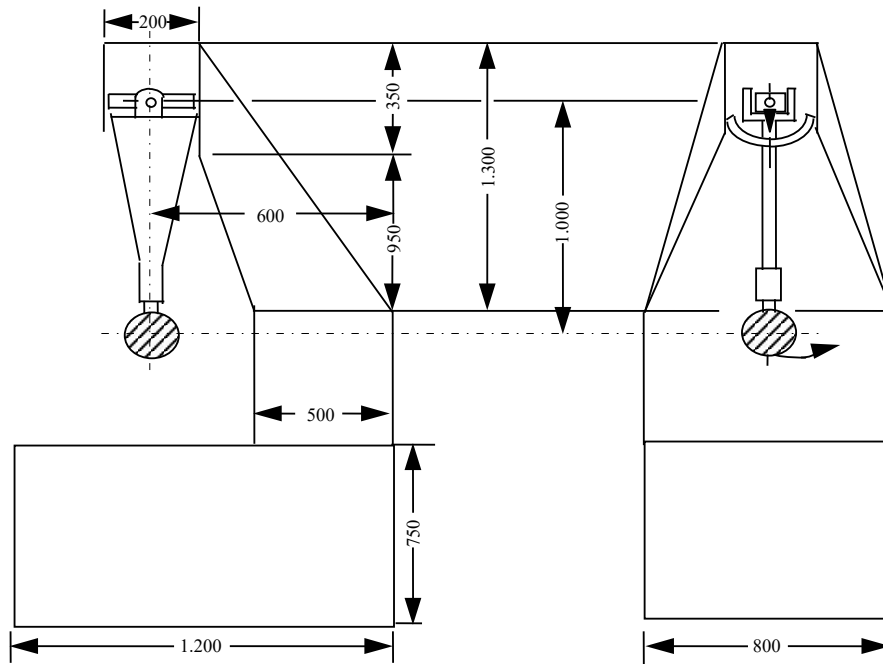

6.2.2.1.2. The centre of percussion of the pendulum coincides with the centre of the sphere, which forms the hammer. It is at a distance l from the axis of oscillation in the release plane, which is equal to $1 \text{ m} \pm 5 \text{ mm}$. The reduced mass of the pendulum is $m_o = 6.8 \pm 0.05$ kilograms. The relationship of m_o to the total mass m of the pendulum and to the distance d between the centre of gravity of the pendulum and its axis of rotation is expressed in the equation:

$$m_o = m \times \frac{d}{l}$$

6.2.2.2. Description of the test

- 6.2.2.2.1.** The procedure used to clamp the device for indirect vision to the support shall be that recommended by the manufacturer of the device or, where appropriate, by the vehicle manufacturer.
- 6.2.2.2.2.** Positioning of the device for indirect vision for the test
- 6.2.2.2.2.1.** Devices for indirect vision shall be positioned on the pendulum impact rig in such a way that the axes which are horizontal and vertical when the mirror is installed on a vehicle, in accordance with the applicant's mounting instructions, are in a similar position;
- 6.2.2.2.2.2.** When the edge of the reflecting surface is not enclosed by the protective housing, the worst case test positions for both impact directions shall be identified by the Technical Service in consultation with the manufacturer.
- 6.2.2.2.3.** In the case of mirrors, except in the case of test 2 for interior mirrors (see paragraph 6.2.2.2.7.1. below), when the pendulum is in a vertical position the horizontal and longitudinal vertical planes passing through the centre of the hammer shall pass through the centre of the reflecting surface as defined in paragraph 2.1.2.2.7. of this Regulation. The longitudinal direction of oscillation of the pendulum shall be parallel to the longitudinal median plane of the vehicle.
- 6.2.2.2.4.** When, under the conditions governing adjustment laid down in paragraphs 6.2.2.2.1. and 6.2.2.2.2. above parts of the device for indirect vision limit the return of the hammer, the point of impact shall be displaced in a direction perpendicular to the axis of rotation or pivoting in question.
- The displacement shall be no greater than is strictly necessary for the execution of the test; it shall be limited in such a way that:
- (a) Either the sphere delimiting the hammer remains at least tangential to the cylinder as defined in paragraph 6.1.3.5.;
 - (b) Or, in the case of mirrors, the impact point of the hammer is located on the reflecting surface at least 10 mm from the periphery of the reflecting surface.
- 6.2.2.2.5.** The test consists in allowing the hammer to fall from a height corresponding to a pendulum angle of 60° from the vertical so that the hammer strikes the device for indirect vision at the moment when the pendulum reaches the vertical position.
- 6.2.2.2.6.** The devices for indirect vision are subjected to impact under the following different conditions:
- 6.2.2.2.6.1.** Interior mirrors
- (a) Test 1: The points of impact shall be as defined in paragraph 6.2.2.2.3. above. The impact shall be such that the hammer strikes the mirror on the reflecting surface side.
 - (b) Test 2: Point of impact on the edge of the protective housing, such that the impact produced makes an angle of 45° with the plane of the reflecting surface and is situated in the horizontal plane passing through the centre of that surface. The impact shall occur on the reflecting surface side.
- 6.2.2.2.6.2.** Exterior mirrors
- (a) Test 1: The point of impact shall be as defined in paragraphs 6.2.2.2.3. or 6.2.2.2.5. above. The impact shall be such that the hammer strikes the mirror on the reflecting surface side.

- (b) Test 2: The point of impact shall be as defined in paragraphs 6.2.2.2.3. or 6.2.2.2.5. above. The impact shall be such that the hammer strikes the mirror on the side opposite to the reflecting surface.

Where exterior mirrors are fixed to the same mounting as other mirrors, the above-mentioned tests shall be executed on the lower mirror. Nevertheless, the Technical Service responsible for testing may repeat one or both of these tests on the upper mirror if this is less than 2 m from the ground.

6.2.2.3. Bending test on the protective housing attached to the stem (Exterior mirror)

6.2.2.3.1. Description of test

The protective housing is placed horizontally in a device in such a way that it is possible to lock the attachment support adjusters firmly. In the direction of the largest dimension of the housing, the end closest to the point of attachment on the adjuster for the support shall be immobilized by a 15 mm-wide rigid stop covering the entire width of the housing.

At the other end, a stop identical to the one described above is placed on the housing so that the specified test load can be applied to it (Figure 3).

The end of the housing opposite to that where the force is exerted may be locked rather than held in position as shown in Figure 3.

Figure 3
Example of Mirror Bending-Test Rig

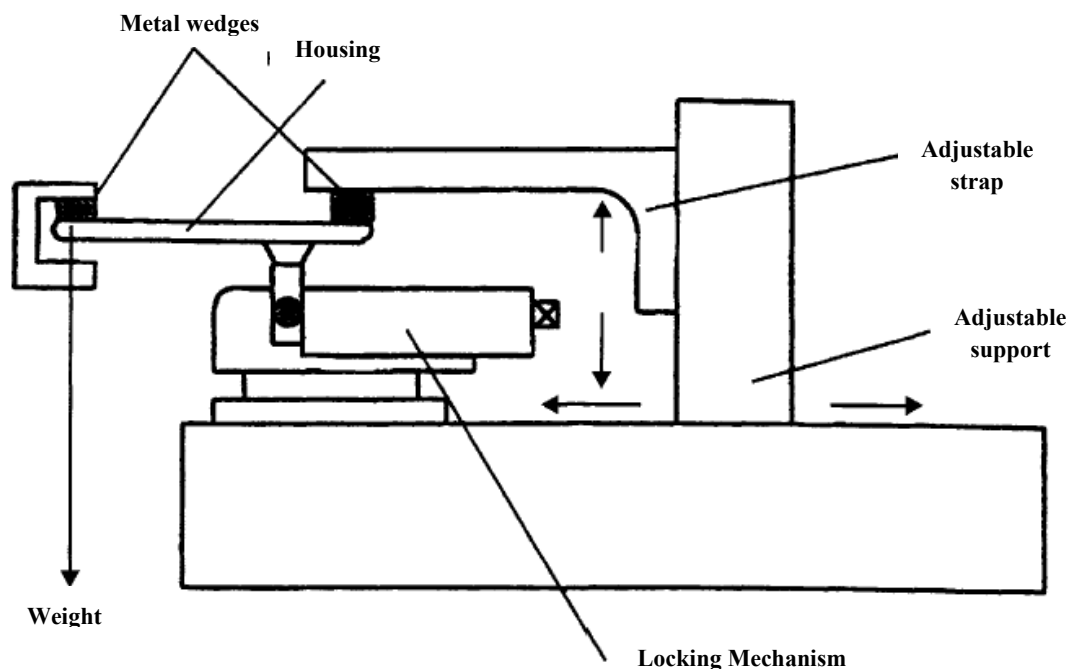

- 6.2.2.3.2.** The test loading shall be 25 kilograms and shall be maintained for one minute.
- 6.2.3.** Results of the tests
- 6.2.3.1.** In the tests described in paragraph 6.2.2. above, the pendulum shall continue to swing after impact in such a way that the projection of the position assumed by the arm on the plane of release makes an angle of at least 20° with the vertical. The accuracy of measurement of the angle shall be within ±1°.
- 6.2.3.1.1.** In the case of mirrors, this requirement is not applicable to mirrors stuck to the windscreen, in respect of which the requirement stipulated in paragraph 6.2.3.2. shall apply after the test.
- 6.2.3.1.2.** The required angle to the vertical is reduced from 20° to 10° for all mirrors for indirect vision.
- 6.2.3.2.** Mirrors should the mounting of the mirror break during the tests described in paragraph 6.2.2. above for mirrors stuck to the windscreen, the part remaining shall not project beyond the base by more than 10 mm and the configuration remaining after the test shall satisfy the conditions laid down in paragraph 6.1.3.2. of this Regulation.
- 6.2.3.3.** The reflecting surface shall not break during the tests described in paragraph 6.2.2. However, breakage of the reflecting surface will be allowed if one of the following conditions is fulfilled.
- 6.2.3.3.1.** The fragments of glass still adhere to the back of the housing or to a surface firmly attached to the housing; partial separation of the glass from its backing is admissible provided that this does not exceed 2.5 mm on either side of the cracks. It is permissible for small splinters to become detached from the surface of the glass at the point of impact.
- 6.2.3.3.2.** The reflecting surface is made of safety glass.
- 6.2.4.** The devices that approved by UN Regulation No.26 or No.61 shall be exempted the requirements of paragraph 6.2. of this Regulation."

Paragraph 12.2., amend to read:

"12.2. "*Ambinocular vision*" means the total field of vision obtained by the superimposition of the monocular fields of the right eye and the left eye (see Figure 4 below).

Figure 4
Monocular Fields
(Direct vision case)

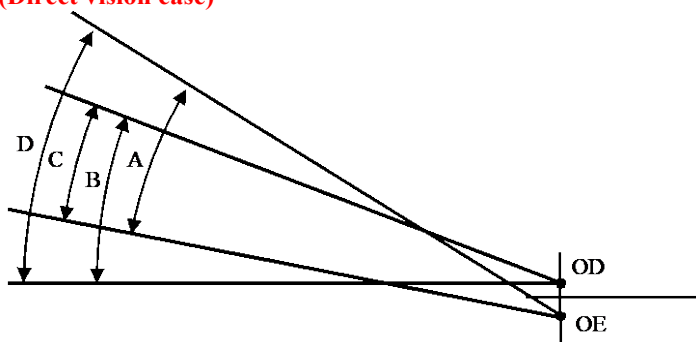

(Indirect vision case)

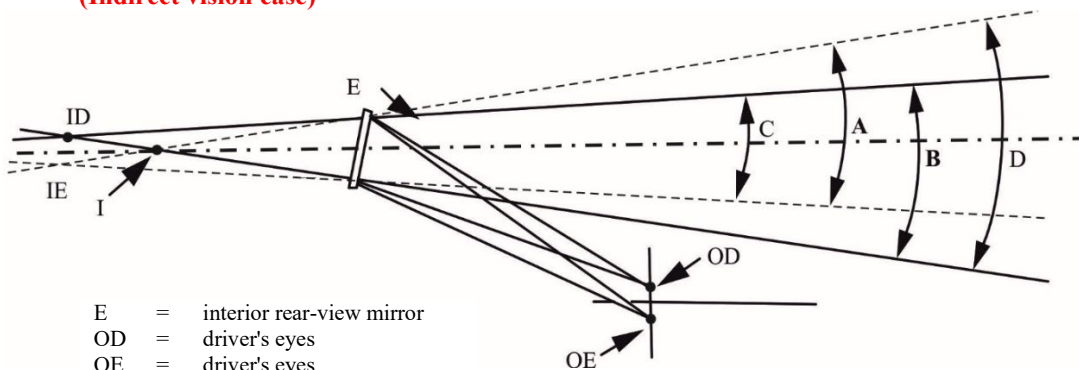

- E = interior rear-view mirror
- OD = driver's eyes
- OE = driver's eyes
- ID = virtual monocular images
- IE = virtual monocular images
- I = virtual ambinocular image
- A = angle of vision of left eye
- B = angle of vision of right eye
- C = binocular angle of vision
- D = ambinocular angle of vision

“

Paragraph 14.2., amend to read:

"14.2. An approval number shall be assigned to each type approved. Its first two digits (at present 00) shall indicate the series of amendments incorporating the most recent major technical amendments made to the Regulation at the time of issue of the approval. **An approval number shall be assigned to each approved type in accordance with Schedule 4 of the Agreement (E/ECE/TRANS/505/Rev.3).** ~~The same Contracting Party shall not assign the same number to another type of device for means of front and lateral vision.~~"

Paragraph 15.1., amend to read:

"15.1. General

For the purposes of this UN Regulation, the vehicle shall fulfil the following requirements:

The vehicle shall be equipped with at least one means of vision or awareness.

Any means using one or several electronic system(s) (e.g. vision camera systems, detection systems), may be activated upon the driver's request.

The combination of means of vision provide a close-proximity front and lateral field of vision as defined in paragraph 15.2. These means shall be selected from:

- (a) Direct vision;
- (b) Devices approved to UN Regulation No. 46, 04 Series of amendments;

- (c) Close-proximity front and lateral view mirror complying with this Regulation; and
- (d) Close-proximity front and lateral view camera system (FLVCS) complying with this Regulation.

The combination of means of awareness shall provide information for field of detection as defined in paragraph 15.3. Possible means are:

These means shall be detection systems complying with this UN Regulation.

Via a combination of the means of vision and awareness, and declared by the manufacturer.

Overlaps of designated areas by different means (see examples in Figure 5) shall be permitted.

The manufacturer shall declare to the technical service which means is used for which designated area, so that the technical service can set up the testing equipment accordingly. This shall be recorded in the test report.

Figure 5
Examples of Designated Area of Each Means (Right-Handed Drive Case)

- (a) **In the case of direct vision, detection system, FLVCS.**

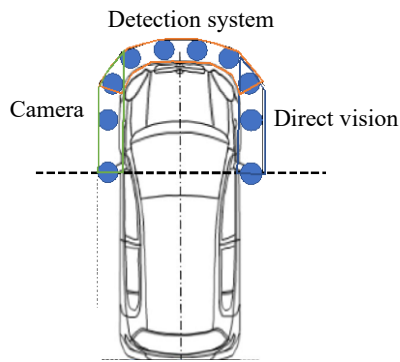

- (b) **In the case of direct vision and mirror.**

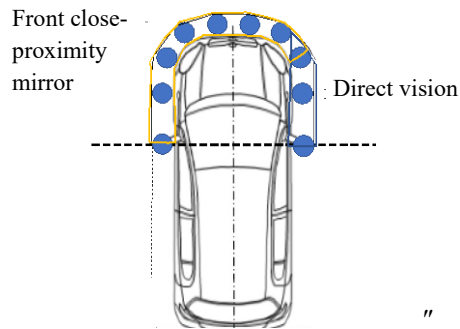

Paragraph 15.2., delete Figure 2 and amend to read:

"15.2. Close-proximity front and lateral sides field of vision

The field of vision (see Figure 2 6 below) shall be bounded by the following planes:

- (a) A **longitudinal** ~~transverse~~ vertical plane passing through a point 300 mm from the contour of the sides of the vehicle;
- (b) A transverse **vertical** ~~horizontal~~ plane passing through a point 300 mm from the contour of the front of the vehicle;
- (c) Areas ahead of the centre of the side mirrors on the driver's seat side and the passenger seat side. In the case of the vehicle that equipped with CMS that comply UN Regulation No. 46, 04 Series of amendments, the

manufacturer shall consider the same vehicle equipped with side mirrors or to use the centre of Class III or II CMS camera lens instead of the centre of the side mirrors.

The contour shall be defined by the vehicle outside shape projection to the ground that can place the test object defined in Annex 9 of this Regulation (300mm diameter pole). Small outside shape irregularity is not included.

Figure 6
Close-Proximity Front and Lateral Sides View Field of Vision

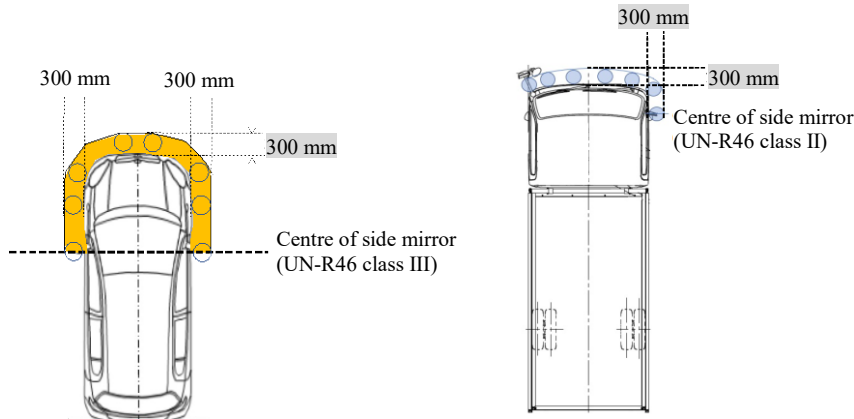

"

Paragraph 15.2.1. amend to read:

"15.2.1. Requirements

When tested under the test method described in Annex 9 and **using ambinocular vision from the adjusted driver's ocular points, or binocular vision from the adjusted ocular reference point calculated by the methods described in Annex 10**, the test object shall be revealed.

The adjusted driver's ocular points calculated by the methods described in Annex 10 does not apply to devices using monitors. "

Paragraph 15.2.1.3., amend to read:

"15.2.1.3. Via a means of indirect vision for front and lateral vision (mirror or camera system or other) complying with this Regulation; ~~or~~"

Paragraphs 15.2.1.4. to 15.2.4.2., shall be deleted.

Paragraphs 15.2.5.(former), renumber as paragraph 15.2.2. and amend to read:

"15.2.2. The close-proximity front and lateral field of vision shall be established using ambinocular vision from the adjusted driver's ocular points, the eyes being at the "driver's ocular points" as defined in paragraph 12.1. or binocular vision from the adjusted ocular reference point **calculated by the methods described in Annex 10**. The fields of vision shall be determined when the vehicle is in running order as defined in the consolidated Resolution on the Construction of vehicles (R.E.3) (ECE/TRANS/WP.29/78/Rev.6 7, paragraph 2.2.5.4.), plus for M1 and N1 vehicles one front seat passenger (75 kg). When established through windows, the glazing shall have a total light transmission factor in accordance with UN Regulation No. 43, ~~01 04~~ series of amendments, Annex 24. "

Paragraph 15.2.6. (former), renumber as paragraph 15.2.3. and amend to read:

"15.2.3. In the case of mirrors consisting of several reflecting surfaces which are either of different curvature or not in the same plane, at least one of the reflecting surfaces shall provide the field of vision ~~and have the dimensions specified for the class to which they belong.~~"

Insert new paragraphs 15.4.1. to 15.4.1.2, to read:

"15.4.1. Activation

15.4.1.1. It shall be possible to easily activate FLVCS and the detection system when the gear is in the out-of-parking or neutral range.

15.4.1.2. FLVCS or detection system that cannot cover all field of means for driver awareness at the same time shall easily show area of the driver's interest by the driver's operations.

It shall be possible to easily activate FLVCS or detection system. In case their combination cannot cover the full field of view, they shall show at least the area of driver's interest. "

Paragraphs 15.4.1. to 15.4.1.4.(former), renumber as paragraphs 15.4.2. to 15.4.2.4.

Insert new paragraphs 15.4.3. to 15.4.3.6., to read:

"15.4.3. Protective housing for the device(s) other than mirrors

~~**15.4.3.1. The edge of the reflecting surface shall be enclosed in a protective housing (holder, etc.) which, on its perimeter, shall have a value "e" greater than or equal to 2.5 mm at all points and in all directions. If the reflecting surface projects beyond the protective housing, the radius of curvature "e" on the edge of the projecting part shall be not less than 2.5 mm and the reflecting surface shall return into the protective housing under a force of 50 N applied to the point of greatest projection, relative to the protective housing, in a horizontal direction, approximately parallel to the longitudinal median plane of the vehicle.**~~

15.4.3.1. When the devices for means of front and lateral vision or detection are mounted in the position recommended by the manufacturer for normal driving, all parts, irrespective of the adjustment position of the device, including those parts remaining attached to the support after the test provided for in paragraph 6.2.2. which are in potential, static contact with a sphere either 165 mm in diameter in the case of devices for means of front and lateral vision or detection or parts of devices for means of front and lateral vision or detection installed inside the vehicle or 100 mm in diameter in the case of devices for means of front and lateral vision or detection or parts of devices for means of front and lateral vision or detection installed outside the vehicle, shall have a radius of curvature "c" of not less than 2.5 mm.

15.4.3.2. The requirements in paragraphs 15.4.3.1. ~~and 15.4.3.2.~~ above shall not apply to parts of the external surface which protrude less than 5 mm, but the outward facing angles of such parts shall be blunted, save where such parts protrude less than 1.5 mm. For determining the dimension of the projection, the following method shall apply:

15.4.3.2.1. The dimension of the projection of a component which is mounted on a convex surface may be determined either directly or by reference to a drawing of an appropriate section of this component in its installed condition.

15.4.3.2.2. If the dimension of the projection of a component which is mounted on a surface other than convex cannot be determined by simple measurement, it shall be determined by the maximum variation of the distance of the centre of a 100 mm diameter sphere from the nominal line of the panel when the sphere is moved over and is in constant contact with that component.

Figure 7 shows an example of the use of this procedure.

Figure 7
Example for the Measurement by Maximum Variation

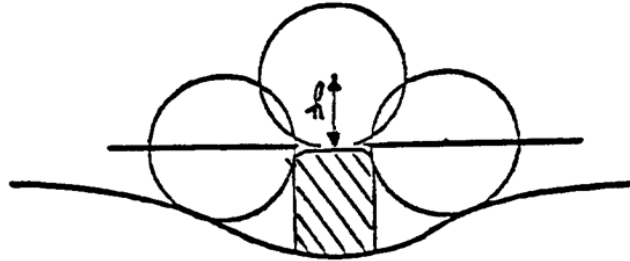

15.4.3.3. Edges of fixing holes or recesses of which the diameter or longest diagonal is less than 12 mm are exempt from the radius requirements of paragraph 15.4.3.2. above, provided that they are blunted.

~~15.4.3.5. The component for the attachment of the device to the vehicle shall be so designed that a cylinder with a 70 mm radius, having as its axis the axis, or one of the axes, of pivot or rotation which ensures deflection of the mirror in the direction of impact concerned, passes through at least part of the surface to which the device is attached.~~

~~15.4.3.6. The parts of exterior the devices referred to in paragraphs 15.4.3.1. and 15.4.3.2. above which are made of a material with a Shore A hardness not exceeding 60 are exempt from the relevant provisions.~~

15.4.3.4. In the case of those parts of interior the devices which are made of a material with a Shore A hardness of less than 50 and which are mounted on a rigid support, the requirements of paragraphs 15.4.3.1. and 15.4.3.2. above shall only apply to the support.

15.4.3.5. The requirements of paragraph 15.4.3.2. do not apply to the devices, if their lower edge is mounted not less than 2 m above the ground when the vehicle is under a load corresponding to its maximum technical permissible mass.

15.4.3.6. The devices that approved by UN Regulation No.26 or No.61 shall be exempted the requirements of paragraph 15.4.3. of this Regulation."

Paragraph 16.2., amend to read:

16.2. Default view

In default view the FLVCS shall show at least the part of the field of view as described in paragraph 15.2.

The FLVCS must default to the front and/or lateral side(s) view image the instruction to activate it is given by the driver."

Insert new Paragraphs 23. to 23.7., to read:

"23. Transitional provisions

23.1. As from the official date of entry into force of the 01 series of amendments to this Regulation, no Contracting Party applying this Regulation shall refuse to grant or refuse to accept type approvals under this Regulation as amended by the 01 series of amendments.

23.2. As from 1 September 2026, Contracting Parties applying this Regulation shall not be obliged to accept type approvals to the preceding series of amendments, first issued after 1 September 2026.

23.3. Until 1 September 2027, Contracting Parties applying this Regulation shall accept type approvals to the preceding series of amendments, first issued before 1 September 2026.

- 23.4. As from 1 September 2027, Contracting Parties applying this Regulation shall not be obliged to accept type approvals issued to the preceding series of amendments to this Regulation.
- 23.5. Notwithstanding paragraph 23.4., Contracting Parties applying this Regulation shall continue to accept type approvals issued according to the preceding series of amendments to this Regulation, for the vehicles and devices for means of front and lateral vision which are not affected by the changes introduced by the 01 series of amendments.
- 23.6. Contracting Parties applying this Regulation may grant type approvals according to any preceding series of amendments to this Regulation.
- 23.7. Contracting Parties applying this Regulation shall continue to grant extensions of existing approvals to any preceding series of amendments to this Regulation."

Annex 5, amend to read:

"Annex 5

Arrangement of Approval Mark for a Device for Means of Front and Lateral Vision

(See paragraph 5.4. of the Regulation)

$a = 5$ millimetre min.

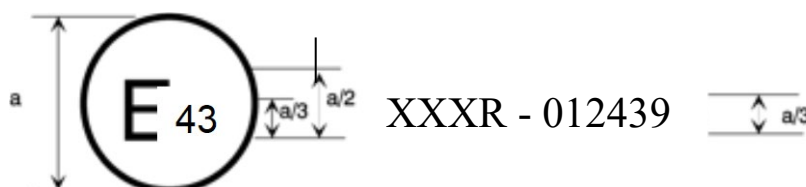

The above approval mark affixed to a device for means of front and lateral vision indicates that the device is a main close-proximity front and lateral view device, which has been approved in Japan (E 43) pursuant to UN Regulation No. 166 and under approval number ~~002439~~ **012439**. The first two digits of the approval number indicate that **UN Regulation No.166 already included the 01 series of amendments when the approval was granted in accordance with the requirements of UN Regulation No. 166 in its original form.** ..."

Annex 9, paragraphs 1.2., amend to read:

- "1.2. The test object shall be in contact with the vehicle's front and lateral side from the centre of passenger side mirror to driver's side mirror shall be seen in the close-proximity front and lateral view field of vision. In the case of the vehicle that equipped with CMS that comply UN Regulation No. 46, 04 Series of amendments, the manufacturer shall consider the same vehicle equipped with side mirrors or to use centres of Class **III or II** CMS camera lens instead of the centres of the side mirrors.

Figure 2
Test Object Locations

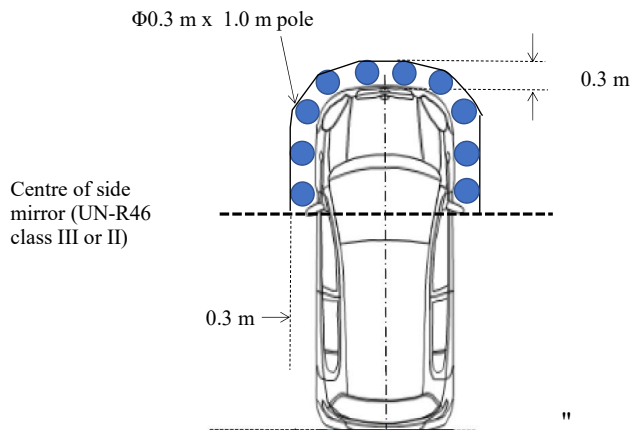

Annex 10, paragraph 1., amend to read (Table 1 unchanged.):

"1. Back angle compensation

~~In testing according to paragraph 15.2.1.1.,~~ Driver's ocular points, or the ocular reference point shall be adjusted in the forward/rearward or upward/downward direction by a specific compensation distance defined according to the respective back angle of the test vehicle, as shown in Table 1.

Table 1
Back Angle Compensation

... "

Annex 10, paragraph 2., amend to read (Table 2 unchanged.):

"2. Movable range compensation for the **front and** passenger's side

~~In testing according to paragraph 15.2.1.1.,~~ As compensation of the driver's ocular points (binocular) or the ocular reference point of the driver moving the body in forward/rearward, lateral, or upward/downward directions to check the vehicle's surroundings at the start of the vehicle, measurements may be taken with the driver's ocular points adjusted in the forward/rearward, lateral, or upward/downward directions, respectively, based on the driver's ocular points or the ocular reference point, provided that it is within the range of compensation distances listed in each column of Table 2.

Adjusted driver's ocular points or the ocular reference point shall be located in a three-dimensional space consisting of four points as follows, the driver's ocular points defined in 12.1. or the ocular reference point defined in 12.2. of this Regulation, and driver's ocular points or the ocular reference point compensation for the stretching defined in table 2.

Table 2
Range of Driver's Ocular Points Compensation for the Passenger's Side Stretching

... "

Annex 10, paragraph 3., amend to read (Table 3 unchanged.):

"3. Looking out compensation for the driver's side

~~In testing according to paragraph 15.2.1.1.,~~ As compensation of the driver's ocular points (binocular) or the ocular reference point of the driver moving the body for looking out from side window to check vulnerable road users around the front side corner, measurements may be taken with the driver's ocular points or the ocular reference point adjusted in the forward/rearward, lateral, or upward/downward directions, respectively, based on the driver's ocular points, provided that it is within the range of compensation distances listed in each column of Table 3.

Adjusted driver's ocular points or the ocular reference point shall be located in a three-dimensional space consisting of four points as follows, the driver's ocular points defined in 12.1. or the ocular reference point defined in 12.2. of this Regulation, and

driver's ocular points or the ocular reference point compensation for the stretching defined in table 3.

Table 3

Range of Driver's Ocular Points Compensation for the Driver's Side Stretching

..."

Insert new Annex 13, to read:

"Annex 13

Necessity of Pendulum Impact Test

Figure 1

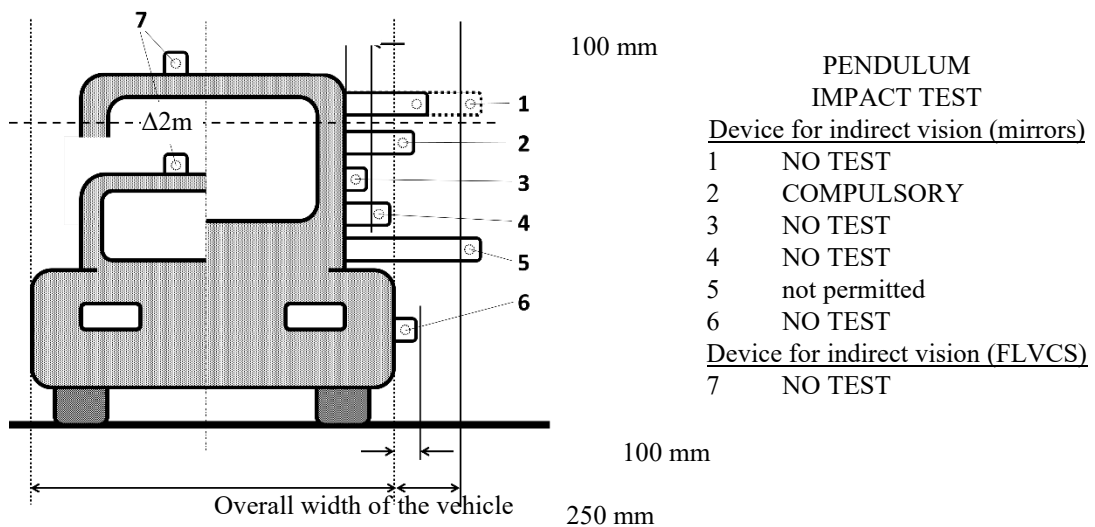

"

II. Justification

1. Paragraphs 1.1.1. and 1.1.2.:
Footnote was missing for the references of vehicle categories.
2. Paragraph 1.1.3.:
This section describes the vehicle approval request by the manufacturer. Therefore, the part on approval (Part I) is not suitable.
3. Paragraphs 5.2. and 14.2.:
The description of approval number harmonized with the 1958 Agreement, Rev.3.
4. Paragraphs 6.1.3. and 6.2.:
The addition of impact safety requirements for mirrors copied from UN Regulation No.46 which reflects the latest amendment (GRSG-126-24r1) and exempt the devices approved by UN Regulation No. 26 or No. 61.
5. Paragraph 12.2.:
Figure was copied from Regulation No.46. It was for indirect vision only. "Ambinocular vision" is for both direct and indirect vision. To prevent misinterpretation, direct vision case figure was added.
6. Paragraphs 15.1., 15.2. and 15.2.1.:

Reorganized between two paragraphs 15.1 and 15.2 for misunderstanding and for clear descriptions. The figures on pole location at the centre of the side mirror were updated to avoid misinterpretation.

~~6. Paragraph 15.1.4.:~~

~~Addition of impact safety requirements for FLVCS and Detection system same as mirror (6.1.3.).~~

7. Paragraph 15.2.5.:

Add description about the driver's ocular point adjustment in Annex 10 for clarification. And, the reference for series of Regulation No.43 is corrected.

8. Paragraphs 15.4.3.1. to 15.4.3.6.:

Addition of impact safety requirements for FLVCS and Detection system same concept as mirror (6.1.3.). These requirements are modified for consistency with CMS requirements of Regulation No.46 Paragraph 6.2.

9. Paragraph 23.:

This proposal is the series of amendment. Therefore, transitional provisions are required.

10. Annex 5:

Corrected to fit the 01 series of amendment.

11. Annex 9:

Add the description for the Class II mirror in the figure.

12. Annex 10:

Remove sentences for clarification

13. Annex 13:

Reflects the latest amendment of UN Regulation No. 46 (GRSG-126-24r1).