



Submitted by the experts of OICA

Informal Document **GRBP-79-37**  
79<sup>th</sup> GRBP, 06 – 09 February 2024  
Agenda Item 7 (c)

# Tyre Abrasion Study for vehicles of category M & N

Study performed by UTAC for ACEA



## Tyre Abrasion Study for ACEA

79<sup>th</sup> GRBP

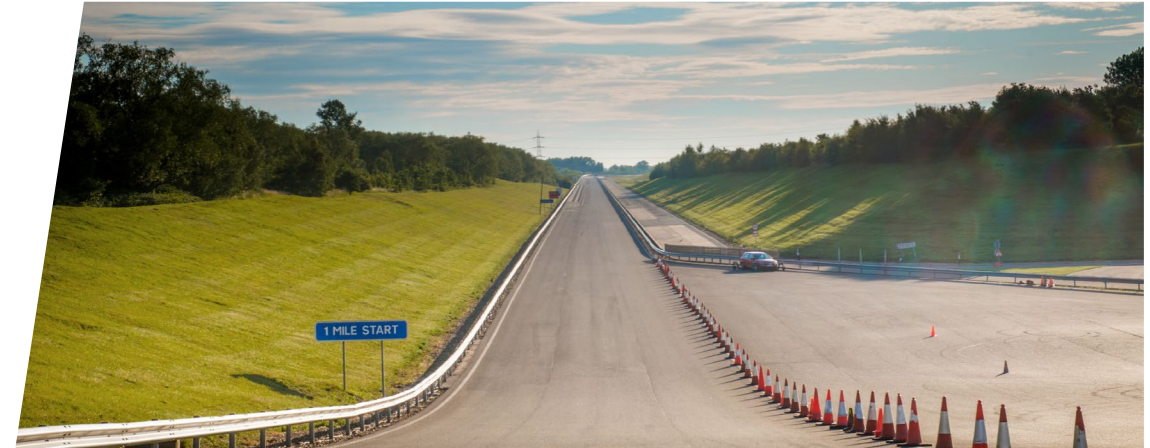

- Tyre Abrasion Study Overview
- WP3 – Real Life Testing
- WP4 – Statistical Analysis
- Conclusions & Recommendations



# TYRE ABRASION STUDY OVERVIEW

- Scope:
  - Theoretical and experimental study of influencing factors on tyre wear / abrasion.
- Objectives:
  - Review GRBP TF TA tyre abrasion requirements proposal: test method, interdependency evaluations, etc,
  - Quantify differences in tyre wear / abrasion in relation to vehicle type (ICE vs BEV),
  - Quantify possible differences between OE and Aftermarket tyres by testing tyres with different label values.
- Work Packages & Timing:

Work Packages		Updated Timing
WP1	Literature Review	Jun-23 (completed)
WP2	EPREL Tyre Database Analysis	Aug-23 (completed)
WP3	Real Life Testing	Aug-23 (completed)
WP4	Test Results Analysis	Analysis: Oct-23 (completed)
WP5	Presentations to GRBP/GRPE:	Interim report: GRBP 78 <sup>th</sup> session (completed) Final report: GRPE 90 <sup>th</sup> session / GRBP 79 <sup>th</sup> session



- Objectives:
  - Quantify differences in tyre wear / abrasion in relation to:
    - Vehicle type: ICE vs BEV,
    - Tyre type: OE vs aftermarket tyres with different label values.
- Vehicles selection:
  - Scope: BEV & ICE vehicles from same model platform,
  - Vehicles: 1 x BMW iX1 xDrive (BEV) vs 5 x BMW X1 (ICE).
- Tyres selection:
  - Scope: C1 summer tyres,
  - Tyre size: 245/45R19 102 Y,
  - Tyre labels (rolling resistance / wet grip):
    - AA (aftermarket, best label combination available, eco tyre for EV),
    - AB (OE homologated, eco tyre),
    - BA (OE homologated, comfort tyre),
    - CA (aftermarket, best-selling based on analysis of French tyre distributors websites, High Performance tyre),
    - DB (aftermarket, worst label combination available, High Performance tyre),
  - Tyres tested before tyre wear test to check wet grip and rolling noise label values.
  - Start of Production: between 23/20 and 29/22
  - DOT: between 20/22 and 19/23

- Circuit:
  - Specifications as close as possible to TADG-ORV Test Method proposal,
  - Open road circuit around UTAC Mortefontaine site (Northern France),
  - Compatible with BEV range & charging constraints.
- Test Method:
  - Test procedure as close as possible to TADG-ORV Test Method proposal,
  - Main differences with TADG-ORV Test Method proposal:
    - 1 double convoy: 3 + 3 vehicles mixing ICE and BEV to limit test time & cost,
    - Reference (REF): BMW X1 (ICE) fitted with AB OE homologated Tyre,
    - Total running distance: 15,000km (8 weeks),
    - Measurement parameters: tyre tread depth and tyre weight.
  - Intermediate measurements every 2,000km:
    - Tyre tread depth,
    - Wheel & tyre assembly weight.
- Timing: July – August 2023

Circuit characteristics	
Length (km)	390
City (km / %)	59 km / 15 %
Road (km / %)	195 km / 50 %
Highway (km / %)	137 km / 35 %
Average speed (km/h)	93,13
Standard deviation speed	32
Standard deviation longi accel (m/s <sup>2</sup> )	0,68
Standard deviation lat accel (m/s <sup>2</sup> )	0,87



- Average weight loss rate per vehicle normalised by vehicle load (Abrasion Level as per TF TA proposal):

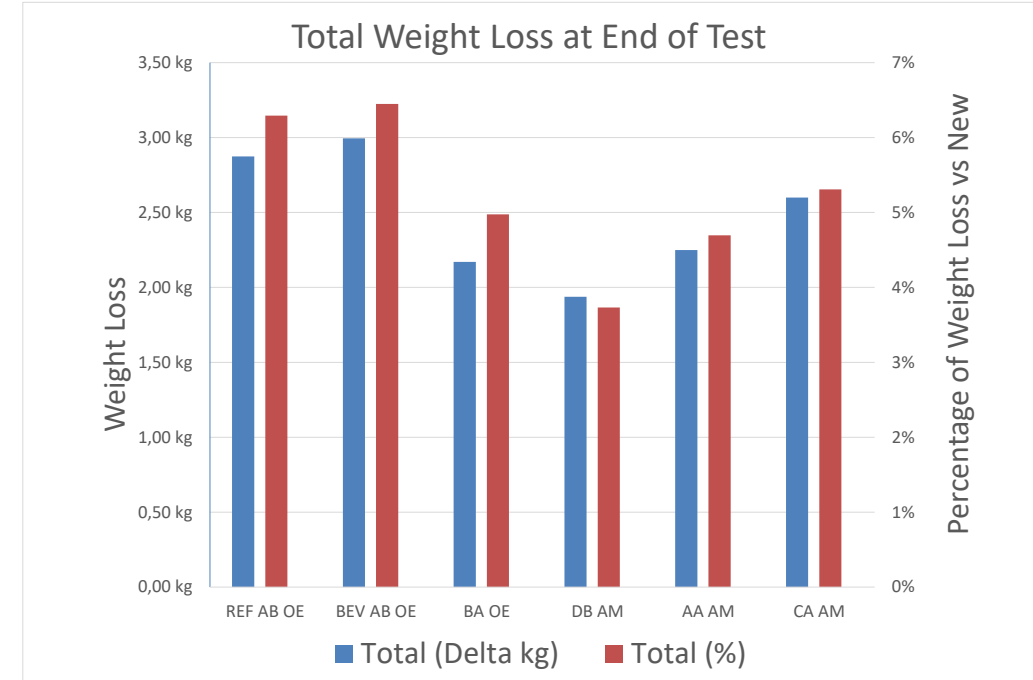
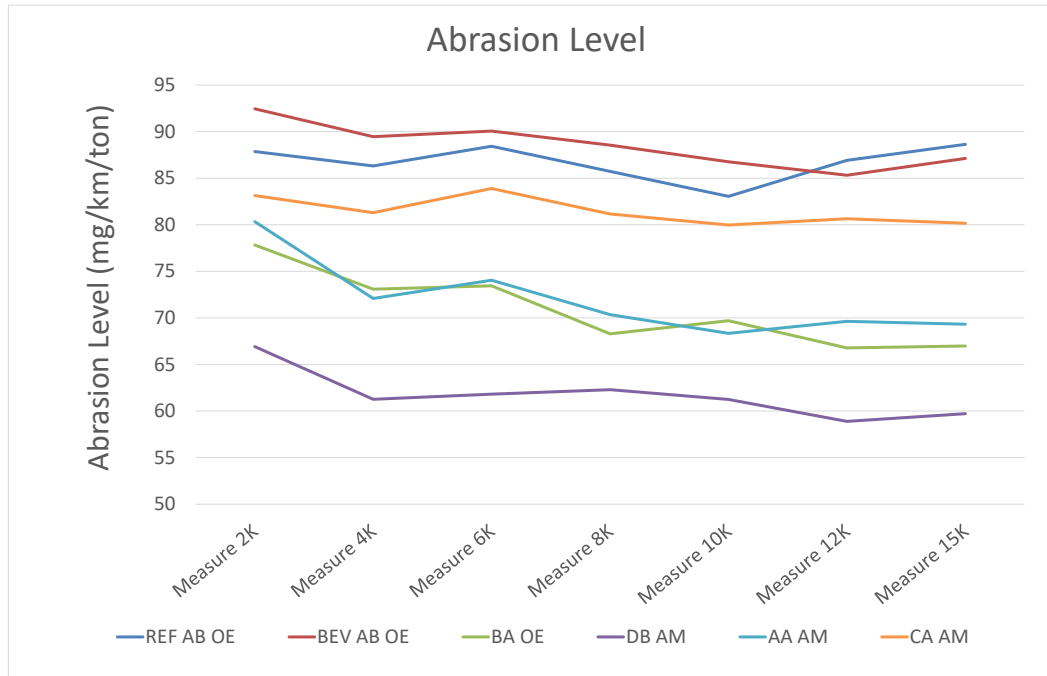

- REF AB OE: Rear Right tyre counted twice due to Rear Left tyre replacement during testing,
- Abrasion level at intermediate distances based on tyre weight loss estimation from W&T assembly measurement,
- Vehicle weight influence observed between ICE and BEV → Change in test results when normalised by vehicle load,
- Similar abrasion level between ICE and BEV when tested in same convoy.

- Average tread depth loss rate per vehicle normalised by vehicle load 15,000km (wear rate):

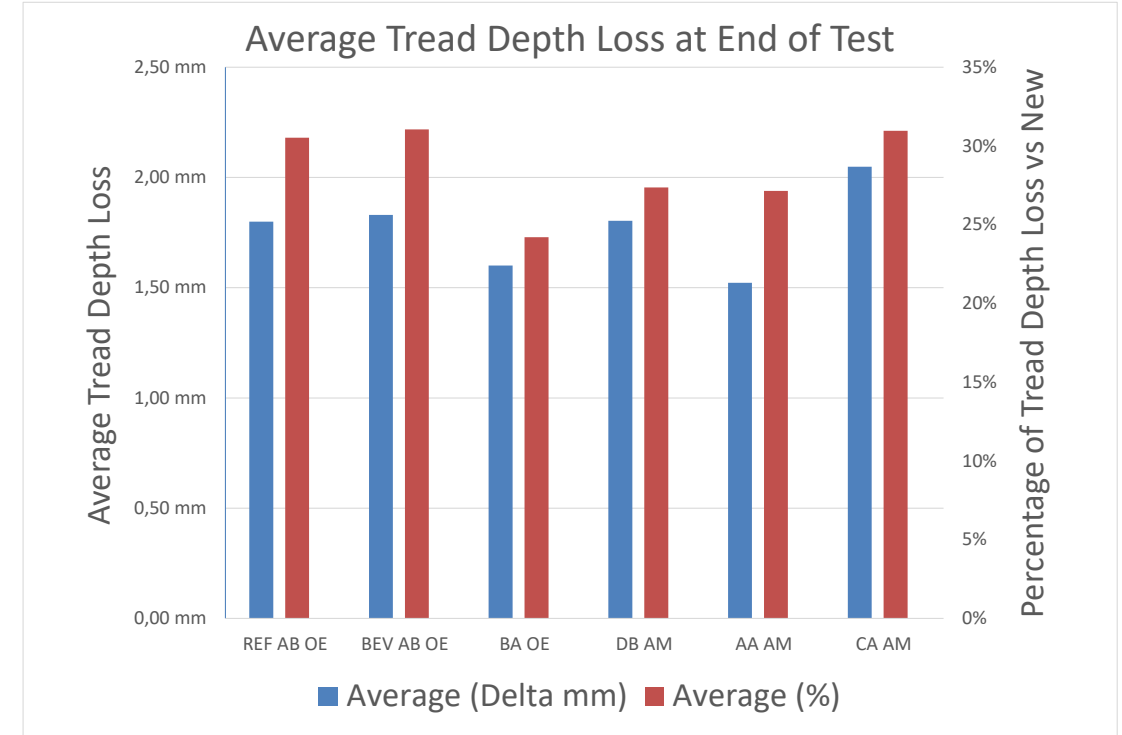
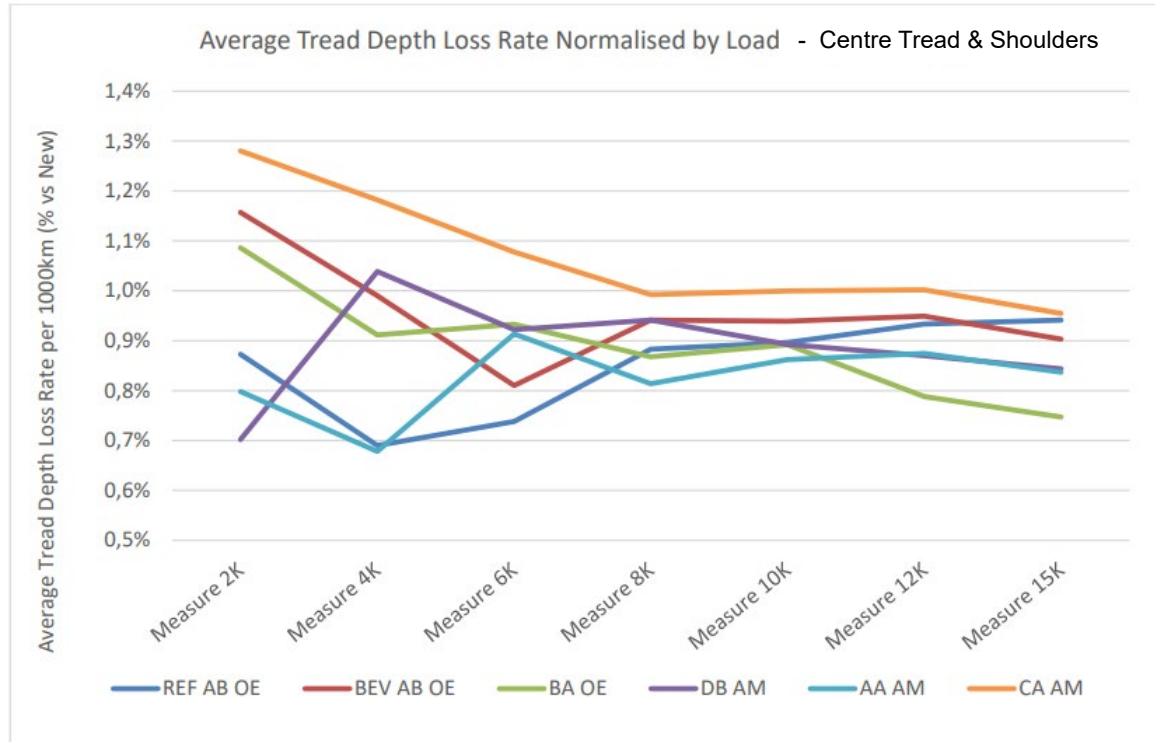

- Difficult to measure accurately tread depth in shoulders area → Larger results dispersion,
- Vehicle weight influence observed between ICE and BEV → Change in test results when normalised by vehicle load,
- Longer test distance required to get stabilized tread depth loss rate compared to abrasion level.



- Statistical analysis of:
  - Tyre label values: Rolling Resistance, Wet Grip, Rolling Noise,
  - Tyre test results: Wet Grip Index, Sound Level, Abrasion Level, Tread Depth Loss Rate.
- Objective:
  - Identify factors involved in tyre wear / abrasion phenomenon from point of view of :
    - Tyre performances interdependency,
    - OE vs AM tyres.
- Analyses carried out:
  - Data exploration: radar chart,
  - Correlation analysis to look for significant relationship between variables when considered one vs another,
  - Principal Component Analysis (PCA) to identify trend between variables.

- Abrasion level:
  - Stabilization at 8,000 km partially confirmed.
  - Vehicle load normalization helps remove impact of vehicle weight on tyre ranking.
- Wear rate:
  - No stabilization observed within 15,000 km → Wear test method specifications for tyre mileage definition to be further investigated included tread depth measurement process.
  - Vehicle load normalization helps remove impact of vehicle weight on tyre ranking.
- Different types of vehicle (ICE vs BEV) does not necessarily lead to significant differences in abrasion level.

- Based on statistical analysis of sample of 6 tyres tested, lower tyre abrasion level tends to imply:
  - Higher noise level,
  - Higher rolling resistance.
- Statistical analysis on larger data set to confirm trends.
- Tyre performance measurement to confirm trends based on tyre label analysis.
- OE Tyre with best safety performance among sample has much higher Wet Grip Index than AM tyres of the same label A.
- Performance trade-offs observed for all tested tyres, no tyre of sample set excels in all performances.



[www.utac.com](http://www.utac.com)

- Tyre performances interdependency:
  - Tyre wear / abrasion vs rolling resistance: good level can be achieved for both performances, depending on:
    - Strategy chosen during tyre development,
    - Type of tyre considered (ie: eco vs high performance / sport).
  - Tyre wear / abrasion vs rolling noise: good level can be achieved for both performances, depending on:
    - Strategy chosen during tyre development,
    - Type of tyre considered (ie: eco vs high performance / sport).
  - Tyre wear / abrasion vs safety: challenging to achieve good level for both performances:
    - Investments required in development and implementation of innovative technical solutions.

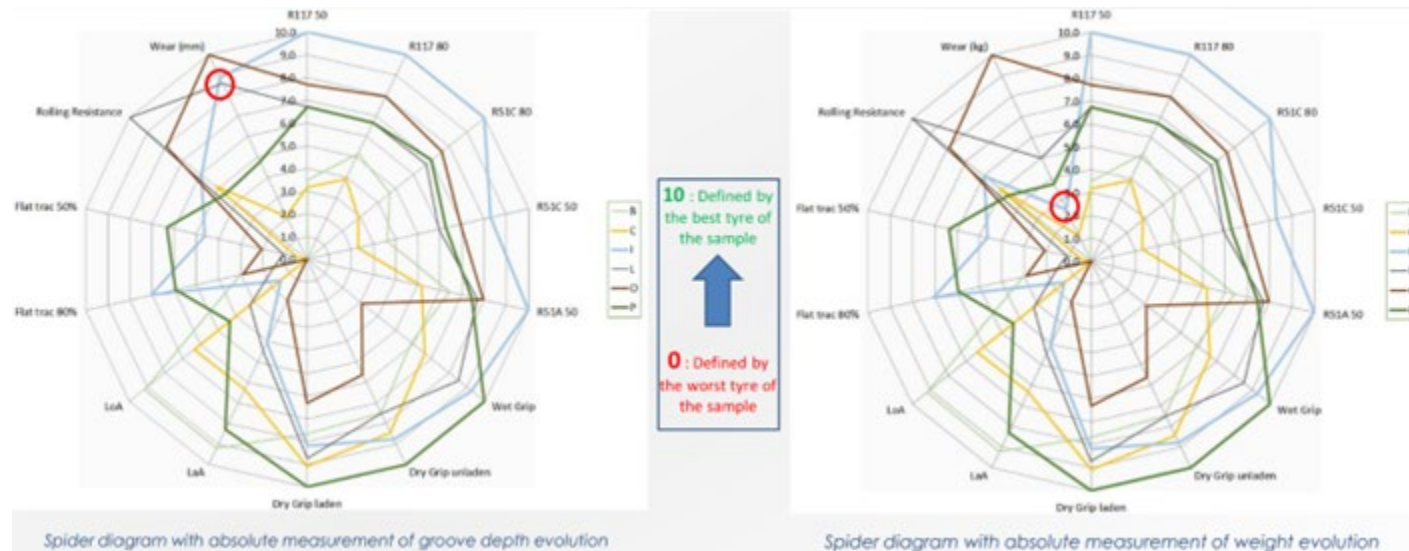

(UTAC, TA-03-04 OICA GRBP-75-19-Rev.1)



- Tyre Labels Value and Tyre Test Results:

Tyre	RR Label	WG Label	Noise Label	WG Index <sup>(1)</sup>	Sound Level (dB(A)) <sup>(2)</sup>	Abrasion Level (mg/km/ton) <sup>(3)</sup>	Tread Depth Loss Rate (mm/1000km/ton) <sup>(4)</sup>
<b>AA - AM</b>	A	A	A (69dB)	1,56	70,2	69,3	0,047
<b>REF AB – OE <sup>(5)</sup></b>	A	B	<b>A (69dB)</b>	1,48	<b>71,2 (B)</b>	88,6	0,055
<b>BEV AB – OE <sup>(6)</sup></b>	A	B	<b>A (69dB)</b>	1,48	<b>71,2 (B)</b>	87,1	0,053
<b>BA – OE</b>	B	A	B (70dB)	1,70	72,5	67,0	0,049
<b>CA – AM</b>	C	A	B (72dB)	1,56	73,8	80,2	0,063
<b>DB – AM</b>	D	<b>B</b>	B (70dB)	<b>1,58 (A)</b>	72,1	58,7	0,056

- Notes:

(1) Wet Grip Index in new state as per Annex 5 to UNR117.

(2) Sound Level only after temperature correction according to §4.3 of Annex 3 to UNR117.

(3) Abrasion Level after 15,000km.

(4) Average Tread Depth Loss rate (centre tread and shoulders) per vehicle normalised by vehicle load after 15,000km.

(5) AB – OE tyre fitted to reference Internal Combustion Engine (ICE) vehicle for tyre abrasion / wear testing.

(6) AB – OE tyre fitted to Battery Electric Vehicle (BEV) for tyre abrasion / wear testing.

- Global Tyre Performance – Radar Chart:

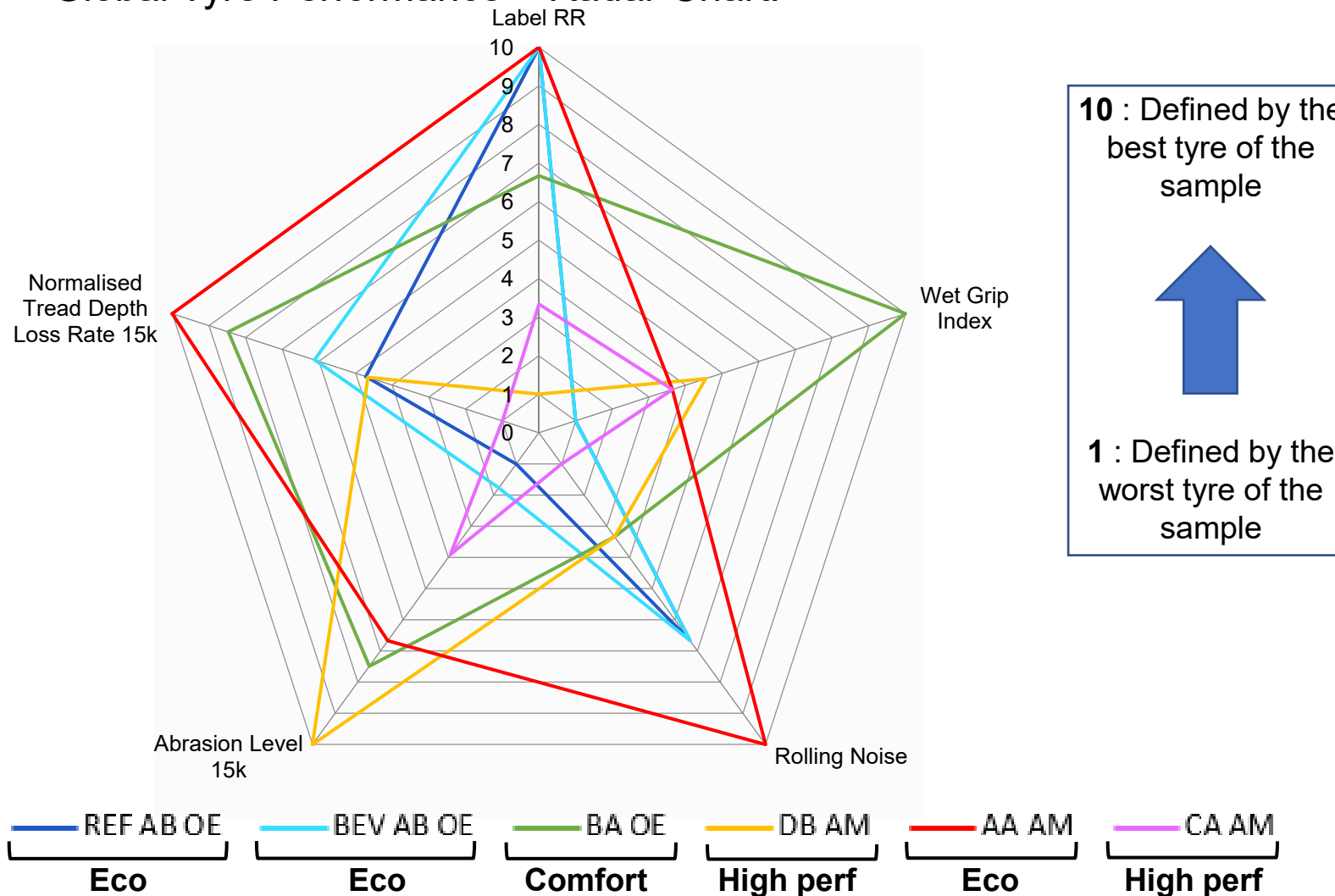

- Observations aligned with WP1 – Literature Review Findings:
  - No clear correlation highlighted with abrasion level or tread depth loss rate.
  - Good tyre in RR can be good for tread depth loss rate.
  - Good tyre in Noise can be good for tread depth loss rate.
  - Good tyre in Wet Grip can be good for tread depth loss rate and abrasion level.
  - Abrasion level and tread depth loss rate not correlated.
- No clear picture to be drawn between:
  - OE vs AM tyres.
  - Eco vs Comfort vs High Performance tyres.
- Handling data would be required to confirm tyres type differences.

- P-Value:
  - The **p-value or probability value** is, for a given statistical model, **the probability that, when the null hypothesis is true, the statistical summary would be greater than or equal to the actual observed results.**
  - In the present case, the null hypothesis is: “**there is no correlation between characteristics**”.
  - In other words, if **p-value is low then the null hypothesis is false** and it can be concluded that **there is a correlation**. The admitted threshold value is: 5%.

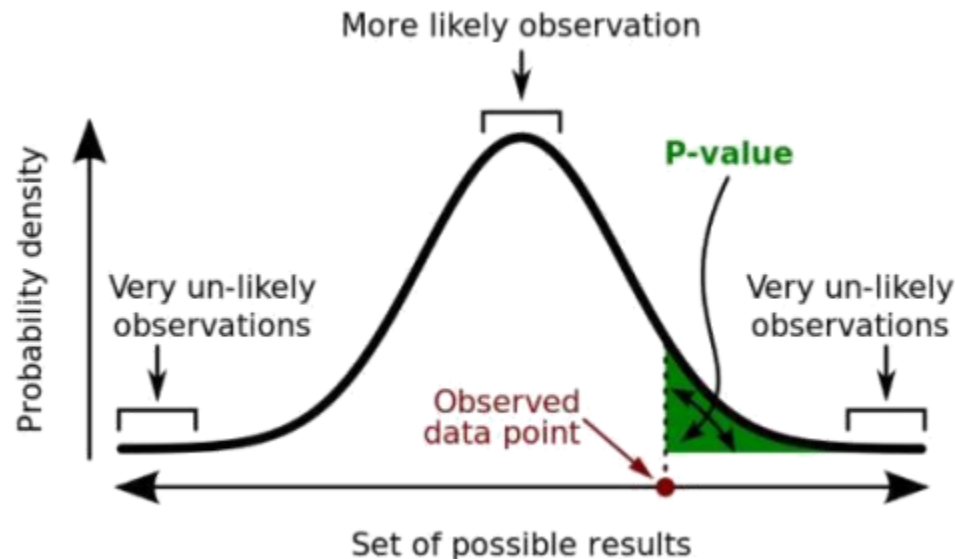

A **p-value** (shaded green area) is the probability of an observed (or more extreme) result assuming that the null hypothesis is true.

- Significant Relationship between variables:
  - Correlation between 2 characteristics if Pearson correlation coefficient is significant (probability value, p-value < 0,05).
- Variables considered:
  - RR label,
  - Wet Grip label,
  - Noise label,
  - RR / Wet Grip / Noise label,
  - Wet Grip Index,
  - Sound Level,
  - Abrasion Level:
    - per Vehicle / Front / Rear,
    - after 2k / 4k / 6k / 8k / 10k / 12k / 15k km,
  - Normalised Tread Depth Loss Rate:
    - per Vehicle / Front / Rear,
    - after 2k / 4k / 6k / 8k / 10k / 12k / 15k km,
    - Centre tread grooves (3 & 4) / Intermediate tread grooves (2 & 5) / shoulders (1 & 6).

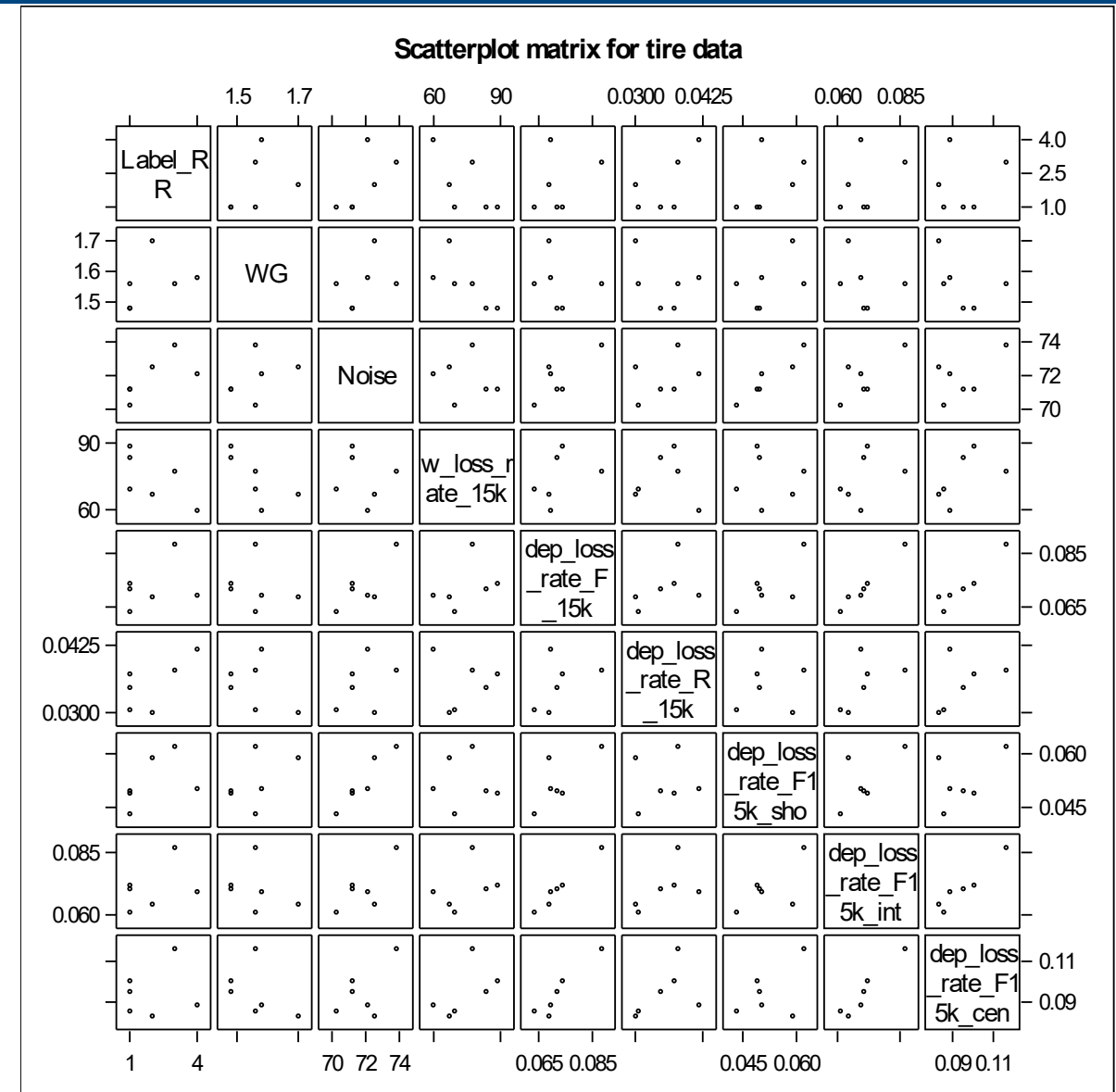

- Significant Relationship with abrasion level or tread depth loss rate:

	Variable 1	Variable 2	Pearson Correlation coefficient example	P-value example
1	Noise	Tread depth loss rate (2k/4k/6k/8k/10k/12k, Front 15k shoulder)	Front 15k shoulder: 0.95	Front 15k shoulder: 0.003
2	Label (RR + WG + Noise) (AAA:3, AAB =4,...)	Tread depth loss rate (2k / 8k, Rear 15k shoulder)	Rear 15k shoulder: 0.93	Rear 15k shoulder: 0.008
3	Label Noise (A=1, B=2 ....)	Abrasion level (Rear 2k / 6k)	Rear 2k: -0.89	Rear 2k: 0.017
4	Label Noise (A=1, B=2 ....)	Tread depth loss rate (2k / 4k / 6k / 8k / 10k, Rear 15k shoulder)	6k: 0.85	6k: 0.031
5	Label RR (A=1, B=2 ....)	Abrasion level (2k, Rear 2k / 6k)	Rear 2k: -0.87	Rear 2k: 0.026
6	Label RR (A=1, B=2 ....)	Tread depth loss rate (2k, Rear 15k shoulder)	2k: 0.87	2k: 0.026

- No correlation found between Noise measurement and abrasion level.
- RR measurements would be required to confirm correlation between RR label and abrasion level.
- No correlation found between Wet Grip and abrasion level or tread depth loss rate.



- Data:
  - n individuals observed on p quantitative variables
  - Individual: element of  $R^p$
  - Variable: element of  $R^n$

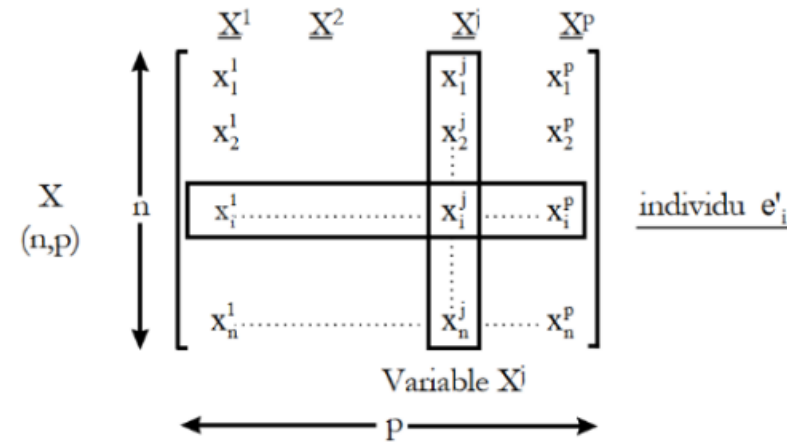

- Cloud of individual representation:
  - To each individual noted  $e_i$ , a point can be associated in  $R^p$
  - Each variable in table X is associated with an axis of  $R^p$ .

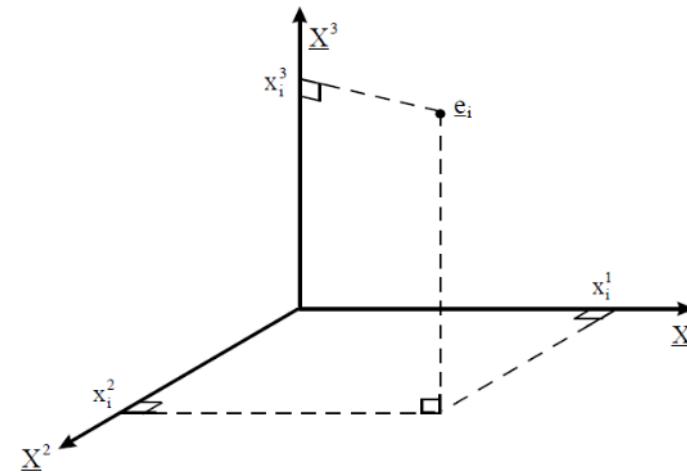

- Cloud of individual representation:
  - Looking for a representation of the  $n$  individuals, in a subspace  $F_k$  of  $R^p$  of dimension  $k$
  - Trying to define  $k$  new variables linear combinations of the  $p$  initial variables that will cause as little information loss as possible.

- As little information loss as possible:
  - $F_k$  will have to be "adjusted" as best as possible to the cloud of individuals: the sum of the squares of the distances from individuals to  $F_k$  must be minimal.
  - $F_k$  is the subspace such that the projected cloud has a maximum inertia (dispersion).
  - Based on notions of distance and orthogonal projection.

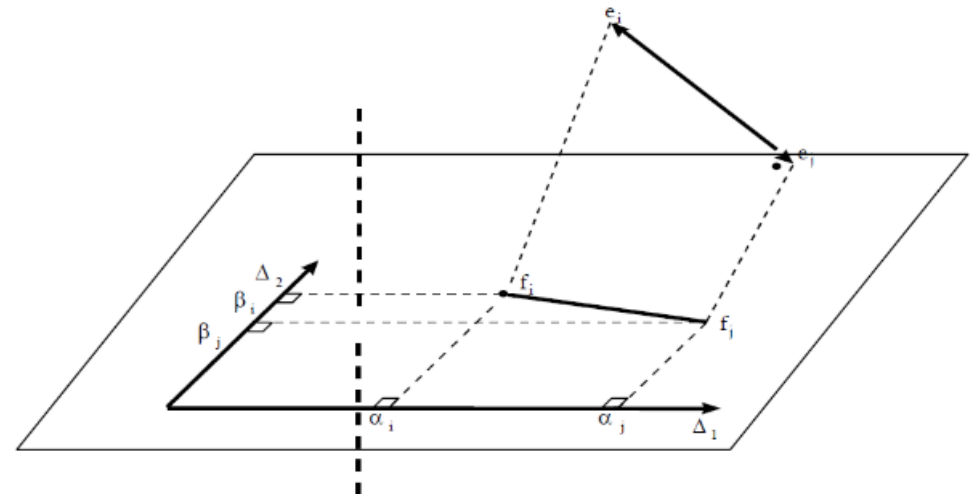
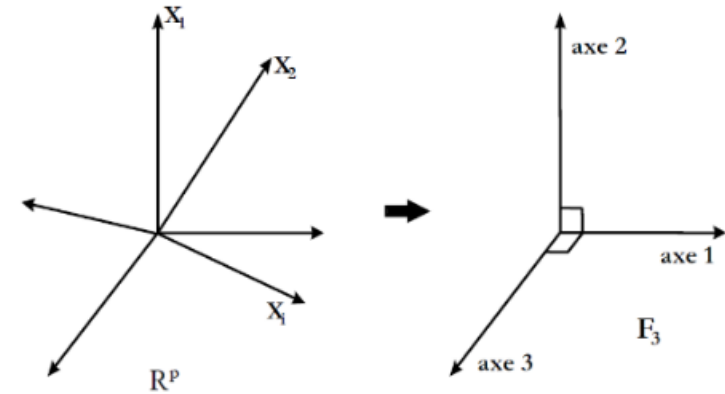

- Principal Component Analysis (PCA):
  - Mathematical procedure used to convert a set of possibly correlated variables into a smaller set of uncorrelated variables called principal components.
  - PCA used here to reduce a set of 20 characteristics (label, RR, Wet Grip, Noise, Tread Depth Loss Rate (after 2k / 4k / 6k / 8k / 10k / 12k / 15k km), Abrasion Level ( after 2k / 4k / 6k / 8k / 10k / 12k / 15k km) to 2 variables.
- PCA results:
  - Inertia of the first dimensions:
    - Shows if strong relationships between variables,
    - Suggests the number of dimensions to be studied.
  - First 2 components of PCA express 88% of the total dataset inertia  
→ 1<sup>st</sup> plane well represents data variability.

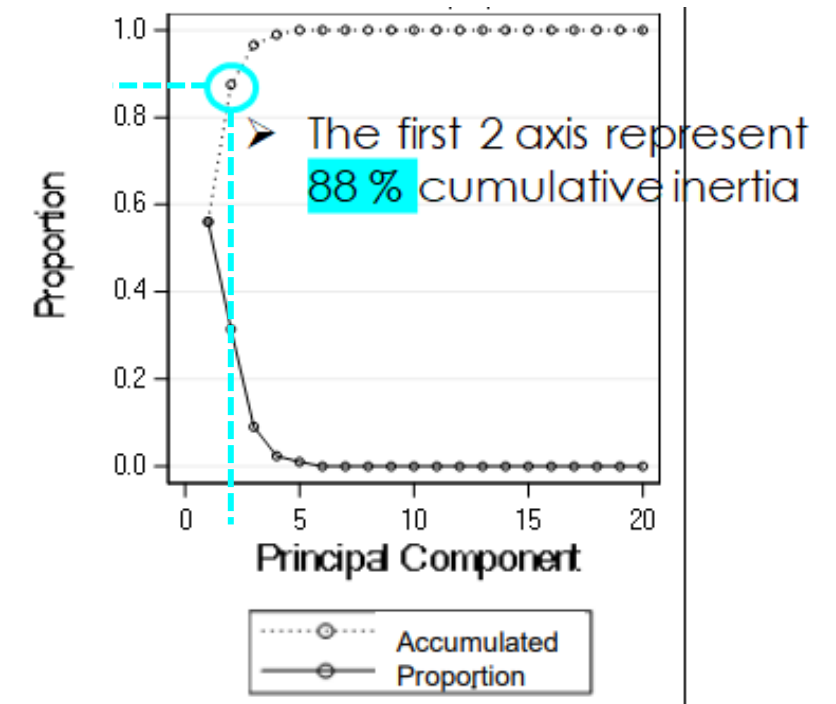

- PCA Results:
  - Circle of correlations: projection of the cloud of variables on the level of the main components.
  - The variables close to the circle are well represented, those close to the origin are poorly represented.

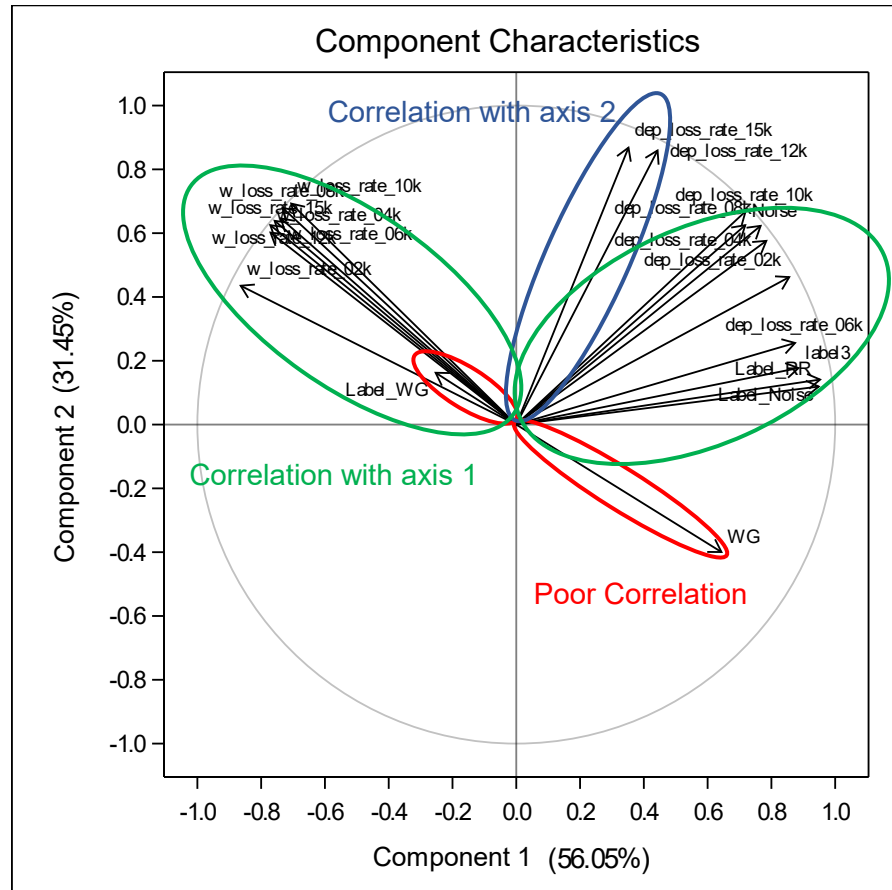

Part of inertia	56%	31%	9%
	Axis 1	Axis 2	Axis 3
Depth loss rate (2-10k)	~ 0.85	~ 0.46	~ -0.08
Depth loss rate (12-15k)	~ 0.44	~ 0.85	~ -0.08
Weight loss rate (2-15k)	~ -0.86	~ 0.43	~ 0.20
label3	0.88502	0.17721	-0.41404
Label RR	0.94854	0.11917	-0.27238
Label WG	-0.25291	0.16245	-0.90412
Label Noise	0.95283	0.14110	0.18091
WG	0.64342	-0.39953	0.55614
Noise	0.71800	0.62501	0.27369

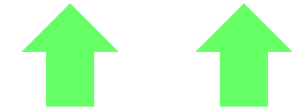

- PCA Visualisation and Explanation:
  - Trend between Rolling Noise and Tread Depth Loss Rate,
  - Opposition trend between Rolling Noise and Abrasion Level,
  - Opposition trend between Abrasion Level and Tread Depth Loss Rate after distances < 10,000km,
  - Different Tread Depth Loss Rate evolution for some tyres after distances > 10,000km.
- Comments on PCA Results Representativeness:
  - PCA can be considered as descriptive method: it summarises the information but does not explain it,
  - Recommended to have a relatively large sample to ensure an optimal statistical power of the analysis: at least a ratio of 10 subjects per variable.
  - With a sample of 6 tyres, trends shown maybe valid for this sample but necessary to remain cautious regarding generalization of interpretations given the representativeness of the tyres' population.

