

Final
September 2022
CEFACT



UNITED NATIONS ECONOMIC COMMISSION FOR EUROPE
UNITED NATIONS CENTRE FOR TRADE FACILITATION
AND ELECTRONIC BUSINESS (UN/CEFACT)

BUSINESS REQUIREMENTS SPECIFICATION (BRS)

Integrated Track and Trace for Multi-Modal Transportation

INTERNATIONAL SUPPLY CHAIN PROGRAMME DEVELOPMENT AREA
TRANSPORT AND LOGISTICS DOMAIN

UN/CEFACT – ISC-PDA/T&L SC-T+T – P1073

SOURCE: SC T+T Project Team
DATE: 14 September 2022
STATUS: **Approved**

Version: 1.1

Each output is based on the contributions of participants in the UN/CEFACT process, who have agreed to waive enforcement of their intellectual property rights pursuant to the UN/CEFACT IPR Policy (document ECE/TRADE/C/CEFACT/2010/20/Rev.2 available at http://www.unece.org/cefact/cf_docs.html or from the ECE secretariat). ECE takes no position concerning the evidence, validity or applicability of any claimed intellectual property right or any other right that might be claimed by any third parties related to the implementation of its outputs. ECE makes no representation that it has made any investigation or effort to evaluate any such rights.

Implementers of UN/CEFACT outputs are cautioned that any third-party intellectual property rights claims related to their use of a UN/CEFACT output will be their responsibility and are urged to ensure that their use of UN/CEFACT outputs does not infringe on an intellectual property right of a third party.

ECE does not accept any liability for any possible infringement of a claimed intellectual property right or any other right that might be claimed to relate to the implementation of any of its outputs.

Table of Contents

Document History	4
Change Log	5
1.0 Preamble	6
1.1 Problem Statement	9
1.2 The UN/CEFACT Cross-Industry Supply Chain Track and Trace Project.....	12
2.0 References	13
3.0 Objective of the UN/CEFACT Cross-Industry Supply Chain Track and Trace Project.....	14
4.0 Scope.....	15
4.1 Description	15
4.2 Context.....	16
5.0 Business Requirements Elaboration	17
5.1 Business Requirements List	17
5.2 Definitions of Business Terms.....	20
5.3 Business Requirements View	20
5.3.1 Business Domain View- Business Areas, Process Areas, Business Processes	20
5.3.2 Business Partner View–Participants and Stakeholders	21
5.3.3 Business Entity View– Entity States, Lifecycle and Conceptual Model.....	22
5.4 Business Choreography View.....	25
5.4.1 Business Transaction View-Transactions and Authorised Roles.....	25
5.4.2 Business Collaboration View-Linked Transactions.....	26
5.4.3 Business Realization View-Business Partner Types and Authorized Roles	26
5.4.4 Business Realization View-Cooperation and Coordination between international standards bodies to enable interoperability	26
LIST OF FIGURES.....	33
APPENDIX 1	36
Definitions of Business Terms:.....	36
APPENDIX 2	38
Pipeline Data Exchange Standards (PDES), further detail:.....	38
APPENDIX 3	44
The GS1 system of standards and EPCIS, further detail:	44
APPENDIX 4	51
Coordination between UN/CEFACT and Other Industry Standards Organizations, further detail:.....	51
UN/CEFACT – GS1	51
UN/CEFACT – COVID-19 Project	64
APPENDIX 5	66

Tracking and tracing business and technical considerations, further detail:	66
Track and Trace overview	66
Benefits from Track and Trace solutions	67
Track and Trace technologies	69
APPENDIX 6	82
Tracking and Tracing Considerations for Bulk.....	82

Document History

Phase	Status	Date Last Modified
Initial	In progress	02 July 2022
Ready for Public Review	In Public Review	03 July 2022
Changes as per Public Review	Changes as per Public Review In progress	Changes submitted in Public Review 14 September 2022

Change Log

Date of Change	Version	Paragraph Changed	Summary of Changes
03 July 2022	1.0		Progressive incremental development by project team and lead editor
14 September 2022	1.1		Changes as addressed on the Master Public Review Comment Log

1.0 Preamble

This document has been structured using the framework of the UN/CEFACT Business Requirements Specification (BRS) and presents a broad overview of the end-to-end supply chain Multi-Modal Transport and Integrated Trace & Trace.

The main challenge (amongst many) is to address the current lack of use of consistent identifiers end-to-end across the many actors involved in any cross-border movement of goods and related service.

- 1) The Project Scope for the entire project has been outlined on the official UN/CEFACT page [Cross Industry Supply Chain Track and Trace Project \(unece.org\)](https://unece.org/Cross_Industry_Supply_Chain_Track_and_Trace_Project). This initial project document indicated 4 deliverables were to be expected: White Paper, BRS, SSBDA message structures and XML schemas.
- 2) A large group of experts from a wide range of backgrounds then did extensive research that resulted in a green paper, which includes a substantial number of potential use cases. This green paper remains a UN/CEFACT internal paper and has not been published official on the UNECE/CEFACT web site. The green paper was deemed to be very comprehensive. It was decided that a streamlined version of the green paper was needed.
- 3) This resulted in the Executive level (20 Page) White Paper (available on) https://unece.org/sites/default/files/2021-06/WhitePaper_Integrated-T-T-MMT_v1E.pdf

NOTE: Based on the work done as part of the Green Paper and the White Paper, the group of experts involved concluded the necessary standard identifiers exist and also the means to exchange them effectively and efficiently. Because of that, there would be no need to develop NEW messages structures and/or XML-schemas. The only remaining deliverable was therefore the document referred to as the BRS (Business Requirements Specification)

- 4) The BRS is this document. Due to the very broad scope of the topic covered as well as the fact that the BRS expressly states that no new standards are to be developed, this document does not (even cannot) follow exactly the “standards” that one would expect to apply for a BRS that would be used for development of a (new) IT system. This BRS document describes an approach on how to apply a combination of existing standards in a specific context, which may be a (small) area within the wider scope of the supply chain covered in this BRS. This BRS may be viewed as an umbrella document under which joint efforts of stakeholders in a specific area can implement the proposed approach to further standardise how the combination of standards may support “Integrated Track and Trace for Multi-Modal Transportation” may be achieved for that specific area (and group of stakeholders). This BRS follows the UN/CEFACT template for Business Requirements to the extent feasible given the intent and objective of this BRS document.

Under this umbrella BRS and when more specific and function-focused projects are called for, these may be mounted by UN/CEFACT provided there is Country support (3 Heads of Delegation minimum) and expert resources identified and committed to such future projects.

This document supports the business requirements for multi-modal Track and Trace functionality, regardless of the mode of transport.

After much investigation by UN/CEFACT experts into the history and current practices of supply chain Track and Trace, it is realized that the disconnection between the trade and transport worlds regarding a consistent set of related trade and transport identifiers can now potentially be closed.

The conclusion of recent UN/CEFACT investigations analyzing and correlating the data elements, context and identifiers from transport documents of the primary modes of transport **is that all of the data elements required for supply chain track and trace are already in the UN/CEFACT Core Component Library located in the Supply Chain Reference Data Model (SCRDM) and Multi-modal Transport Data Reference Data Model (MMT-RDM) subsets.**

Therefore, closing the disconnect between trade and transport can be accomplished by using the UN/CEFACT Supply Chain Reference Data Model (SCRDM)¹ and the UN/CEFACT Multi-Modal Transport Reference Data Model (MMT-RDM)² in combination with digitalization methods and consistently applied standardized identification schemes of other recognized standards organizations currently in use within and across supply chains.

In that regard, the following starting points are now assumed for this BRS:

- a) There is no present need for additional data identifiers to facilitate multi-modal tracking and tracing of trade shipments transported from seller to buyer.
- b) Identifiers for goods, their packaging or container, or means of transport will support multi-modal tracking and tracing, if the identifiers are unique.
- c) Linkages can be made between the different identifiers using various existing technologies.
- d) The model supports track and trace using various existing technologies by using the most relevant waypoints for the transport journey (as agreed among stakeholders).
- e) Standardized exchange processes may be used, without the need to create new class diagrams or new message structures.

Track and Trace refers to IT-supported systems for determining the processing or delivery status of an object within a physical supply chain of a production or logistics company.³ There are different definitions of real-time tracking and tracing, as according to Oliveira et al. (2013), the core task of a track-and-trace system is to create end-to-end transparency within a logistics chain so that customers, business partners and the logistics company itself, can see the exact production or delivery status at any time.⁴

Lin et al. (2013), define traceability as the ability to trace the whole supply chain processes backwards after delivering the materials and products.⁵ Furthermore, Främling and Nyman (2009), divide tracking-and-tracing into a forward and a backward aspect; forward tracking is defined as the determination of the location of products along the supply chain processes, whereas, backward tracing refers to the identification of defective or lost articles in the logistics network.⁶ For Shamsuzzoha et al. (2013) proper track-and-trace of all necessary information from the supply network is necessary for efficient and effective management.⁷ Therefore, supply chain partners have to collaborate closely together and define track-and-trace requirements, to enable supply chain forward, backward and real-time visibility, efficiency, effectiveness, agility to cope with demand and ecosystem variability.

¹ https://unece.org/DAM/unecefact/BRS/BRS_SCRDM_v1.0.0.2.pdf.

² https://unece.org/DAM/cefact/Standards/MMT/BRS_T_L-MMT.pdf.

³ Hassan, M., Ali, M., Aktas, E., & Alkayid, K. (2015). Factors affecting selection decision of auto-identification technology in warehouse management: An International Delphi study. *Production Planning & Control*, 26(12), 1025-1049.

⁴ Oliveira, R. R., Noguez, F. C., Costa, C. A., Barbosa, J. L., & Prado, M. P. (2013). SWTRACK: An intelligent model for cargo tracking based on off-the-shelf mobile devices. *Expert Systems with Applications*, 40(6), 2023-2031.

⁵ Lin, X., & Zheng, X. (2013). A Cloud-Enhanced System Architecture for Logistics Tracking Services. *International Conference on Computer, Networks and Communication Engineering*, 30, 545-548.

⁶ Främling, K., & Nyman, J. (2009). From Tracking with RFID to Intelligent Products. *14th IEEE International Conference on Emerging Technologies and Factory Automation*, 122-132.

⁷ Shamsuzzoha, A. H. M., Ehrs, M., Addo-Tenkorang, R., Nguyen, D., & Helo, P. T. (2013). Performance evaluation of tracking and tracing for logistics operations. *International Journal of Shipping and Transport Logistics*, 5(1), 31-54.

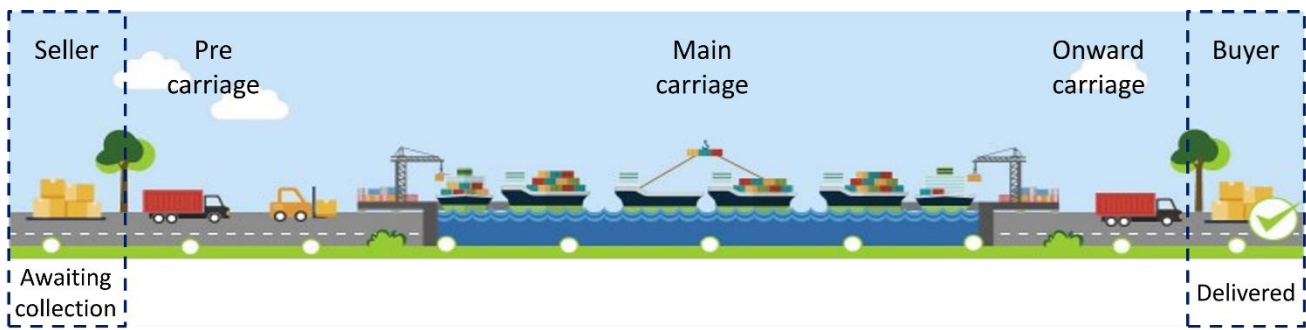

Figure 1. Sample supply chain requiring track & trace for trade shipments from seller to buyer of goods.

Figure 1 above clarifies the scope of this BRS within the context of the above discussion of tracking and tracing. Supply chain may be understood as running from raw materials, through various stages of production through semi-finished products and ultimately to finished products that involve several buy-sell transactions of goods among different actors along that supply chain. The scope of this BRS is limited to tracking and tracing related to a single buy-sell transaction between a single Seller and a single Buyer.

Supply chain visibility over time has become a crucial factor for companies in terms of customer satisfaction. Therefore, the importance of track and trace technologies developed into important tools to enhance forward, backward and real-time visibility, efficiency, effectiveness, agility to cope with demand and ecosystem variability as indicated above.⁸

Supply Chain transparency, in the context of this document, is also of importance in regard to information and communication technologies as a part of sustainable supply chain management.⁹ Actually, many supply chain related issues arise due to the lack of sharing information between the members in the supply chain.¹⁰ Supply Chain transparency is the ability to track a wide variety of goods during transport, to have a clear overview of inventory. It enables companies to improve their customer service and cost control by managing inventory in motion, proactively updating status, limiting disruptions and mitigating risks.¹¹

Collaborations between trading partners in information sharing facilitates decision synchronization between these partners, contributing towards achieving significant business performance.¹²

- Information sharing is critical to the efficiency, effectiveness and competitive advantage of a supply chain.¹³
- Information sharing improves buyer-supplier relationships.¹⁴
- Information sharing is the heart of supply chain collaboration.¹⁵

⁸ Bolte, N.-O., & Goll, D. C. (2020). Potential analysis of track-and-trace systems in the outbound logistics of a Swedish retailer (Dissertation). Retrieved from <http://urn.kb.se/resolve?urn=urn:nbn:se:hj:diva-48986>.

⁹ Schäfer, N. (2022). Making transparency transparent: A systematic literature review to define and frame supply chain transparency in the context of sustainability. *Management Review Quarterly*. <https://doi.org/10.1007/s11301-021-00252-7>.

¹⁰ J. Li, M. J. Shaw, R. T. Sikora, G. W. Tan, and R. Yang, (2001). "The effects of information sharing strategies on supply chain performance," Working Paper, URL: <http://citeseerx.ist.psu.edu/viewdoc/summary?doi=10.1.1.144.4916>.

¹¹ Gnimpieba, D. R., Nait-Sidi-Moh, A., Durand, D., Fortin, J. (2015). Using Internet of Things Technologies for a Collaborative Supply Chain: Application to Tracking of Pallets and Containers. *10th International Conference on Future Networks and Communications*, 56, 550-557.

¹² Simatupang, T. M., Wright, A. C. & Sridharan, R. (2004). Applying the theory of constraints to supply chain collaboration." *Supply Chain Management: An International Journal* 9 (1), 57-70.

¹³ Stock, J. R., & Lambert, D. M. (2001). Strategic logistics management.

¹⁴ Hsu, C. C., Kannan, V. R., Tan, K. C., & Leong, G. K. (2008). Information sharing, buyer-supplier relationships, and firm performance: a multi-region analysis. *International Journal of Physical Distribution & Logistics Management*, 38(4), 296-310.

¹⁵ Min S., Roath A.S., Daugherty P.J., Genchev S.E., Chen H., Arndt A.D., Richey R.G., (2005). Supply chain collaboration: what's happening? *International Journal of Logistics Management*; 16: 237-256.

Information sharing is the at the base of building a more agile, resilient and sustainable supply chain.

As an example, the broad use of advanced information technologies in supply chains, such as Electronic Data Interchange (EDI) and Web Technologies, demonstrates that organizations have come to substantiate the importance of integrating information.¹⁶

Increased transparency during the multi-modal transportation of traded goods from seller to buyer offers new opportunities and huge benefits for supply chain optimization that did not exist prior to the widespread adoption of digital technologies. However, currently there are gaps in the process in the flow of this information that must be connected.

The business-to-business (B2B) and business-to-consumer (B2C) worlds have been tracking and tracing separately for years and the supporting methods and technologies used have been gradually improving. Nevertheless, there is still no single standardized approach which is proven to be able to link between the trade and transport domains in all situations.

As a result of the current global digitalization efforts by many trade standards organizations and with cooperation and coordination between these bodies, it is now envisioned that a combination of such standards is needed and sufficient to close the communications' gap regarding the movement of goods specified as trade items in a sales order contract (a.k.a. trade transaction items). Future operational and systems interoperability and communications between seller and buyer are now within reach.

1.1 Problem Statement

Currently there are disconnects in the process of the flow of information from Seller to Buyer that must be closed.

Stakeholders involved in the trade transaction (sales order contract) and stakeholders involved in the transportation of consignments of the trade deliveries (trade shipments) of goods covered in the sales order contract use common terms and definitions in different ways. For instance, the terms "trade shipment" and "consignment" are not used with the same meaning across different trading industries and different modes of transport. The various parties may also use different identifiers for the same objects. For example, transport service contracts for services provided by different modes of transport are identified by different names (e.g., road consignment note, waybill, master air waybill, bill of lading, rail consignment note, etc.).

Figure 2 below defines two of the key terms for which we need to resolve the operational and communications disconnect in the end-to-end seller-to-buyer supply chain. A **Trade Shipment** is a *trade* term for the goods that are purchased and need to be transported to the buyer. **Consignment** is a *transport* term for the evidence of a transport service contract by which trade shipment(s) are transferred to transport operators to be moved under the terms of the associated transport service contract(s). The cargo moved as a consignment may be constituted from multiple trade shipments, a single trade shipment, or a portion thereof.

¹⁶ Lotfi, Zahra and Mukhtar, Muriati and Sahran, Shahnorbanun and Taei Zadeh, Ali, (2013). Information Sharing in Supply Chain Management. The 4th International Conference on Electrical Engineering and Informatics 2013 (ICEEI 2013), Available at SSRN: <https://ssrn.com/abstract=2290870>.

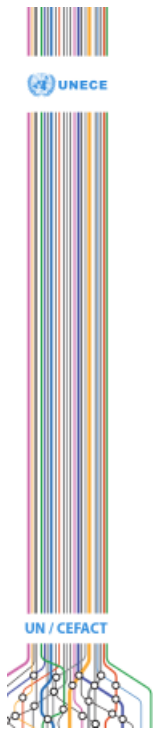

Global Trade – Semantic Anchors

Shipment (Trade Delivery)

- A shipment is an identifiable collection of one or more Trade Items (available to be) transported together from the Seller (Original Consignor/Shipper) to the Buyer (Final/Ultimate Consignee):
 - A Shipment can only be destined for one Buyer
 - A Shipment can be made up of some or all Trade Items from one or more Sales Orders
 - A Shipment can have only one Customs UCR
 - A shipment may form part or all of a Consignment or may be transported in different Consignments.

Consignment

- A consignment is a separately identifiable collection of Consignment Items (available to be) transported from one Consignor to one Consignee via one or more modes of transport as specified in one single transport service contractual document:
 - A Consignment can only have one Transport Service Buyer
 - A Consignment can only have one Transport Service Provider
 - A Consignment can only have one Consignor
 - A Consignment can only have one Consignee
 - The Transport Service Buyer can be either the Consignor or the Consignee
 - A Consignment is made up of one or more Consignment Items
 - A Consignment can be made up of some or all Trade Items (aggregated into Consignment Items) from one or more Shipments

Copyright UNECE

2

Figure 2. Understanding the difference between the shipment (trade view) and the consignment (transport view).

As trade deliveries (a.k.a. trade shipments¹⁷) move through the end-to-end transportation journey from seller to buyer, each subsequent stakeholder may issue a new identifier to the objects and entities handled in an individual transport movement stage. During the transportation processes, often the logical and technical links across the objects and entities involved in the end-to-end journey are neither captured nor referenced in down-stream communications. The result is that few, if any, of the stakeholders can obtain a complete overview of the actual end-to-end supply chain related to the goods of the trade shipments moved as consignments.

Because each operational stage may use different digital environments to identify and communicate information about the goods being moved, the need for interoperability between the operational processes and their systems becomes essential. As mentioned above, tracking and tracing provide significant benefits for the original consignor (seller) and final consignee (buyer), as well as for subsequent Logistics Service Providers (LSPs) and other stakeholders involved in the movement of the trade shipments through the complete transportation chain.

The ultimate goal in supply chain movement and communication is to ensure that the flow of goods is as smooth, predictable, reliable, resilient and sustainable as possible based on the exchange of information that guarantees, “What is understood is what is sent¹⁸”.

Keeping track of the tsunami of transportation of goods and the related data pertinent for identification and location are imperative for all supply chain stakeholders. Motivated by factors such as operational efficiency standards, competitive pressures, heightened customer expectations, and governmental regulations, both public and private organizations are searching for mechanisms to reduce risks by gaining data-driven visibility into the physical location, condition, and context of their

¹⁷This paper uses the term trade shipment to refer to the Trade Delivery (also indicated in Figure 1).

¹⁸ [Direct quote from the European Interoperability Framework \(EIF\).](#)

products and assets (Delen, Hardgrave, & Sharda, 2009)¹⁹. The ability to track products and assets (in real-time) throughout the value chain has become increasingly important in a wide range of industries²⁰ and it would fundamentally transform supply chain management. Appendix 5 provides an overview of the various tracking and tracing technologies that will assist in achieving the real-time capture and exchange of track and trace data.

Universal (real-time) track and trace capabilities will enable digital ecosystems (digital supply chains) to flourish overcoming current logistics inefficiencies. Companies will have full visibility and sovereignty²¹ of their supply chains as part of fully interconnected logistics networks so that transport assets and resources are used for optimum efficiency. Unfortunately, today transport and logistics do not offer these universal track and trace capabilities. In the future, it is envisioned that supply chain management will move toward supply chain 'demand' management, as customers realize the value and access to more complete and reliable data.²²

Digitalization is an important instrument in realizing a reliable and sustainable future transport system and supply of goods.²³ Digitalization has the immense opportunity to reduce emissions from logistics by as much as 10 to 12% by 2025 and help decarbonize the global economy.²⁴

Sustainability, in recent years, is becoming an important part of the everyday decision-making process of enterprises within local and global Supply Chains (SCs).²⁵ Sustainable Supply Chains (SSCs) are broadly defined by the three pillars of sustainability (i.e. economic, environment and social aspects):

- Economic sustainability deals with costs and financial abilities of SCs.
- Environmental sustainability deals with the impact of SCs on the environment.
- Social sustainability studies the impacts of SCs on societies, human well-being, and stakeholders.²⁶

Note: Although not in scope for this Track and Trace project, sustainability and its benefits provide economic and environmental impetus to adopt digital technological tracking solutions.

The above considerations lead to profit margin pressure as costs creep up throughout the supply chain network. The costs of the SC or Digital Supply Chain (DSC) come from many areas, and unless organisations create visibility of and accountability for reducing those supply chain costs, they may result in rising operational expenses as a whole. Having good tracking and tracing solutions in place for goods moving through the supply chain is a foundational requirement to achieve this.

Information about events related to cargo movements between different geographical nodes and operations, such as loading/unloading/transfer, is captured at different levels of granularity in the different systems operated by the transport operators and Logistics Service Providers (LSPs) involved.

¹⁹ Delen, D., Hardgrave, B.C., Sharda, R. (2007). RFID for better supply chain management through enhanced information visibility. *Prod. Oper. Manage.* 16 (5), 612–624.

²⁰ Butner, K. (2010). The smarter supply chain of the future. *Strategy Leadership* 38 (1), 22–31.

²¹ See *JRC LIVE - Regaining supply chain sovereignty*

https://www.youtube.com/watch?v=kGuloacnsVI&list=PLxdsc7eCmCO4k8RC_PiXW_OZAEbKqu271&index=2.

²² Maersk, *The Race to Super-Proof the Supply Chain*, Wired, 2022.

²³ PwC (2016). *The era of digitized trucking: Transforming the logistics value chain*.

PwC. <https://www.strategyand.pwc.com/gx/en/insights/2016/era-of-digitized-trucking.html>.

²⁴ WEF (2016). "World economic forum white paper. Digital transformation of Industries: logistics industry", in Spelman, M., Weinelt, B., Lehmacher, W., Padilla-Taylor, V., Shah, A., Pearson, M., Pinhack, M., Dittrich, M., Daberkow, J., Shroff, S. and Agrawal, P. (Eds), World Economic Forum & Accenture, p.26, available at: <http://reports.weforum.org/digital-transformation/wp-content/blogs.dir/94/mp/files/pages/files/wef-dti-logisticswhitepaper-final-january-2016.pdf>.

²⁵ Mujkic, Z., Qorri, A., & Kraslawski, A. (2018). Sustainability and optimization of supply chains: A literature review. *Operations and Supply Chain Management: An International Journal*, 186-199. <https://doi.org/10.31387/oscm0350213>.

²⁶ Bhinge, R., Moser, R., Moser, E., Lanza, G., & Dornfeld, D. (2015). Sustainability Optimization for Global Supply Chain Decision-Making. *Procedia CIRP*, 26, p. 323-328.

One of the primary results of gaps in the data is that the parties involved do not share information sufficiently, while some of the important linking details remain only within their own systems. Transport operators may not have all the prior assigned reference IDs required to adequately link back to the original trade transaction between the seller and the buyer. In order to establish end-to-end visibility across the supply chain from seller to buyer, such data must be accessible to all interim stakeholders. Therefore, it is important to provide the stakeholders with track and trace information to guarantee that transportation of goods and their related events are in concurrence with the expected procedures, most specifically in providing on-time delivery to the final consignee (buyer).

1.2 The UN/CEFACT Cross-Industry Supply Chain Track and Trace Project

This business requirements specifications (BRS) will enable the tracking of each identifiable asset by retrieving the information about the locations and events that affect the asset during transportation. Required tracking data should be transmitted in real or near-real time²⁷ in electronic format either directly from a technological solution or keyed into a system by a stakeholder.

The following sections of the BRS describe the overall approach and primary considerations. Further detail and examples of such using the UN/CEFACT MMT-RDM combined with other organizations standards bodies' work are found within the attached Appendices.

For example, see Appendix 5, Tracking and Tracing business and technical considerations, for further detail on potential benefits, and technological considerations.

²⁷ Definitions in Appendix 1.0 References, for Real Time and Near Real Time per official documentation from the United States Department of Defense (DOD):

real time: https://www.militaryfactory.com/dictionary/military-terms-defined.php?term_id=4438

near real time:

https://www.militaryfactory.com/dictionary/military-terms-defined.php?term_id=3653.

2.0 References

- UN/CEFACT Multi-Modal Transport Reference Data Model (MMT-RDM)
- UN/CEFACT Modelling Methodology (UMM) v2.0
- UN/CEFACT Supply Chain Reference Data Model (SCRDM) UN/CEFACT Core Components Business Document Assembly, Technical Specification, Version 1.0; 27 June 2012
- BUSINESS REQUIREMENTS SPECIFICATION (BRS) BUY – SHIP – PAY Reference Data Model (BSP-RDM) Approved: UN/CEFACT Bureau on 13 August 2019 Version: 1.0
- DATA PIPELINE CARRIER PIPELINE DATA EXCHANGE STRUCTURE (PDES, Business Requirement Specification (BRS), [T L-BRS DataPipeline v1.pdf \(unece.org\)](#)
- UNECE Interoperability for data and document exchange in multimodal transport aligned to UN standards, UN project to respond to the COVID-19 crisis, 11 December 2020
- Traceability and Transparency in the Textile and Leather Sector, Part 1: High-Level Process and Data Model - Business Requirements Specification (BRS) [BRS-Traceability-Transparency-TextileLeather-Part1-HLPDM v1.pdf \(unece.org\)](#)
- ICAO-UNECE Meeting of Experts on Supply Chain Digitalization Collaboration, 20 January 2021
- The UN/CEFACT REVISION OF RECOMMENDATION 2 PROJECT Proposed title: Semantic information and codes in international trade data exchange, currently draft for public review, 12 October 2021
- BUSINESS REQUIREMENTS SPECIFICATION (BRS) - Smart Containers. Approved: UN/CEFACT Bureau on 30 September 2019 Version: 1.0
- Final draft White Paper; VERIFIABLE CREDENTIALS FOR CROSS BORDER TRADE. UN/CEFACT Bureau approved 7 July 2022
- UNECE/UN/CEFACT INTEGRATED TRACK AND TRACE FOR MULTI-MODAL TRANSPORTATION, WHITE PAPER, 20 April, 2021, <https://unece.org/trade/uncefact/guidance-material>

3.0 Objective of the UN/CEFACT Cross-Industry Supply Chain Track and Trace Project

The objective of this project is to gain the visibility of the traded product at any time during its journey from seller to buyer:

- Enable tracking and tracing of products (or assets) and information sharing in standard electronic format.
- Track and trace any traded and identified items including transport equipment or assets (e.g., box, pallet, container, etc., even if empty).
- Trade or transport items must be identified based on commonly accepted, global data standards non-proprietary), regardless of the recognized standards body.

4.0 Scope

4.1 Description

This project addresses transportation involving large quantities of goods covered under a single sales order contract, as is often the case in bulk transport (see Appendix 6), as well as transportation of very small quantities of goods (often, also quite small in size) such as those typically traded via internet transactions (e-commerce, be it business to consumer or business to business sales)²⁸.

The scope of the project covers two distinct concepts:

- a) **tracking** - which is monitoring and recording the current location and status of the traded goods, once consigned to a transport operator(s), and
- b) **tracing** - which is monitoring and documenting the history of transport of traded goods from original consignor to final consignee, i.e., the combined history of the tracked events, regardless of the type of goods or the mode(s) of transport deployed for their transportation.

Note: Tracking and tracing can also include the events of returning goods or returning the transport asset itself to an originating location when empty. Tracking and tracing of an identifiable asset, itself, is therefore also applicable even when the asset is empty.

The following goals are within the scope of this project:

- **Standard electronic formats for all information exchanges concerning the transportation of traded goods as consignments:** The extent of the information exchanges is to support communications throughout the end-to-end transport supply chain from seller to buyer and vice versa in the case of returned goods. UN/CEFACT will identify the data elements and their business relationships with reference to the UN/CEFACT Multi-Modal Transport Reference Data Model (MMT-RDM). These data exchange specifications will also be applicable to empty, full or consolidated transport assets (container of any size and shape). This will enable the exchange of the location and status of cargo at any time in the transportation chain, regardless of the type of container in which the goods are located or the mode of transport.
- **Proposals of methodologies to close the gaps between the trade transaction and related trade shipment identification(s) and the transport consignment identification(s) in order to reconcile the two and thereby increase transparency across the entire supply chain.**

The following items are not within the scope of this UN/CEFACT project:

- Trade transaction processes, except despatch and delivery related identifiers
- Transport service contract processes, including charging details
- Differentiation by individual commodities of goods transported
- Customs and other cross-border regulatory reporting
- Transport environmental aspects or related concerns such as carbon footprints (environmental condition is mentioned as a potential additional part of the tracking process, but is explained in more detail within the *UN/CEFACT Smart Container Project* deliverables²⁹)
- Fixed transport UN Rec 19.7 – refers to installations for continuous transport, such as pipelines, ropeways and electric power lines

²⁸ Most cargo movements in the world today are linked to e-commerce and this proportion can be expected to increase going forward.

²⁹ The UN/CEFACT Smart Container project developed standards and other documents. [See project overview.](#)

4.2 Context

Tracking and tracing overview

Logistics processing for a product includes a complex set of stakeholders in the middle between seller and buyer, but there is still one single, end-to-end sales transaction involved for a specific set of goods, that moves through this multi-modal supply chain.

Goods are often consolidated, deconsolidated and may be re-consolidated within larger transport packaging during their journey. Identifications for these new packaging levels tend to vary greatly. Goods often pass through many locations from the moment they are ready for sale until the moment they are delivered to a buyer (potentially halfway around the world).

Today, the granularity of tracking is primarily focused on the means of transport or transport equipment as trackable transport assets, in which the traded goods are placed for efficiency and protection from damage. It is often thought that if we know the location of the trackable transport asset, we know the location of the traded goods therein; in other words, equating the asset to the goods. However, this is not a one-to-one relationship, and may vary over time. Goods may be consolidated, split, deconsolidated or re-combined at waypoints during the transport journey. Thus, the transport assets and their associated identifiers may come and go during the journey from original consignor to final consignee, but primary identifiers do not change. The primary identifier used by different modes of transportation may currently require a different primary identifier during an intermodal transfer. The main challenge is to ensure that the links (that are currently often missing) are created and communicated at every stage in the life cycle of the trade shipment (and associated consignments).

Due to the lack of communication abilities between different systems, goods can get lost at points of hand-over once they have transitioned past one system to the next. Not all the data may be registered within the system of the subsequent handling partner, which leads to a permanent break, regarding visibility of each product along the supply chain.³⁰ In addition, the cost must be considered, because tracking gaps and parcel losses lead to unnecessary costs, such as re-scanning, value replacement and handling costs; sometimes, companies try to overcome these issues, by implementing additional systems, which should bridge the gap, bringing clarity at handover points. Unclear data transfer and handover points can lead to track-and-trace gaps and lack of overall supply chain visibility. The challenge is to create a tracking system, that is beneficial for all parties in the supply chain; therefore, to implement such, trust among all parties must be developed. Once the crucial step of sharing relevant data among all parties is achieved, all handling parties within the supply chain would have a more detailed view into processes; furthermore, it ultimately leads to an improved overall performance of the supply chain. The aim of data integration in supply chain management is to accomplish enhanced visibility, which is understood as “the ability to know exactly where things are at any point in time, or where they have been, and why”.³¹

This BRS aims to provide an approach and guidance on how stakeholders involved in the movement of goods between Seller and Buyer may capture and communicate the relevant identifiers in a consistent way to achieve seamless tracking and tracing throughout the life cycle of the trade shipment.

³⁰ Bolte, N.-O., & Goll, D. C. (2020). Potential analysis of track-and-trace systems in the outbound logistics of a Swedish retailer (Dissertation). Retrieved from <http://urn.kb.se/resolve?urn=urn:nbn:se:hj:diva-48986>.

³¹ GS1. (2012). GS1 | The Global Language of Business. https://www.gs1.org/docs/annual_report/GS1_Annual_Report_2012.pdf.

5.0 Business Requirements Elaboration

5.1 Business Requirements List

Identifiers: To provide the missing links between the trade and transport processes, identifiers must be assigned to the consignments that can be referenced or accessed throughout any of the movements or locations of the consigned goods. In order to locate the trade shipments from Seller to Buyer end-to-end as they are transported to their final destinations, it is currently necessary to link a unique trade shipment ID with all the various transport consignment IDs. In those cases, end-to-end tracking through multiple transport modes may not be possible because the stakeholders further down the supply chain may not receive the trade shipment ID.

Note. This standard does not define new identifiers' structural formats. However, it is highly recommended to use the widely business-adopted identifier's standard format. The only mandatory requirement is the use of unique identifiers.

Multi-modal supply chains currently require unique ID's. (See Figure 3 below):

Object or term and definition	Synonym	Example(s) IDs	Assigned by
Trade Shipment <i>A trade shipment is an identifiable collection of one or more trade Items (available to be) transported together from the <u>seller</u> (original consignor/shipper), to the <u>buyer</u> (final/ultimate consignee).</i>	Trade Delivery Trade Shipment	Trade Shipment ID ³² Trade delivery ID	Seller
Consignment³³ <i>A separately identifiable collection of consignment items to be transported or available to be transported from one consignor to one consignee in a supply chain via one or more modes of transport, where each consignment is the subject of one single transport service contract.</i>	Consignment Transport shipment Transport Service Contract Transport Order	CMR no. or ID Bill of Lading ID Air Waybill ID Railway bill ID	Transport (logistics) services provider
Consignment item <i>An item within a consignment of goods separately identified for transport and customs purposes.</i>	Goods items Commodity (item)	Item ID/Name Commodity ID/Code/Name	Transport (logistics) services provider
Logistic Package <i>A self-contained wrapping or container within which goods can be contained for logistics purposes, such as a box or a barrel which can be filled, partially filled or empty (part of the trade shipment).</i>	Transport unit Logistic Unit	Package ID Parcel ID Box ID Pallet ID Bag ID Receptacle ID	Stakeholder related to the trade shipment.
Logistic Unit <i>An item of any composition established for transport and/or storage, which needs to be managed through the supply chain. It is a</i>	Transport Unit	Box ID Pallet ID Container ID	Stakeholder related to the trade shipment.

³² The [UNECE Track & Trace White Paper](#) used the term "Master Transport ID". That term is not wisely used in practice and the term may cause confusion among stakeholders. Hence not include in this BRS.

³³Definition taken from

https://service.unece.org/trade/unecefact/publication/Transport%20and%20Logistics/MMT%20IFTM_UNECE/HTML/04398.htm .

Object or term and definition	Synonym	Example(s) IDs	Assigned by
combination of a logistics carrier, such as a pallet, and products contained.			
Product Packaging <i>The wrapping material around a consumer item that serves to contain, identify, describe, protect, display, promote and otherwise make the product marketable and keep it clean.</i>	Supply Chain Packaging Consumer Packaging	Product Code or ID <i>(Occasionally product packaging itself is cargo, then it can be specified on the cargo label).</i>	Seller, Manufacturer,
Trade Item A Trade Item describes the lowest level of "commercial" information in a sales order contract between the seller and the buyer. Each trade Item will usually be associated with a particular product or material and will include details.	Product, Material, Commodity, Part	Product code or ID Material code or ID Commodity code or ID Part ID	Seller, Manufacturer, Industry Association
Sales Order Contract <i>An agreement between two or more parties, especially one that is written or spoken and enforceable by law.</i>	Sales Order Trade Transaction Sales Contract	Order ID, Sales Transaction ID Sales Contract ID,	Seller
Transport Service Contract A contract specifying a separately identifiable collection of consignment Items transported from one consignor to one consignee via one or more modes of transport.	Consignment Transport shipment Transport Order	CMR no. or ID Bill of Lading ID Air Waybill ID Railway bill ID	Transport (logistics) services provider
Transport Means <i>A powered device used to convey people, cargo, animals or other objects from place to place.</i>	Vessel Truck Aircraft Barge	IMO vessel no. Truck license plate no. Aircraft ID Barge ID	Transport means manufacturer or owner
Transport Equipment <i>A piece of equipment used to hold, protect or secure cargo for logistics purposes.</i>	Shipping container Unit Load Device Wagon Rail car Trolley Roll-cage	BIC code ULD Code Wagon ID/no. Rail car ID Trolley ID Roll-cage ID	Transport equipment manufacturer or owner
Transport Unit (see <i>Logistic Unit, Logistic Package</i>)			
Movement of transport means <i>The conveyance (physical carriage) of goods or other objects <u>by a transport means</u>.</i>	Flight Voyage Journey	Flight no. Voyage no. Journey ID.	Transport (logistics) services provider (carrier, carriers' agent)
Movement of goods <i>The conveyance (physical carriage) of goods or other objects used for logistics transport purposes.</i>	Manifest Cargo document Cargo list Customs manifest	Air cargo manifest no. Shipping manifest no. Train manifest ID	Transport services provider (carrier, carriers' agent)
Location of goods The physical location of the consigned goods in whichever transport equipment, transport means or transport network hub	Location Place Logistic Location (if the location is used for logistic	Depot ID Warehouse ID Distribution Centre ID Terminal ID Cross-dock ID	Manager of the location

Object or term and definition	Synonym	Example(s) IDs	Assigned by
they are at a moment in time during transportation, such as in-flight / in-warehouse.	purposes)	(Transport) hub ID Port of loading ID Port of discharge ID	
Other IDs assigned by a stakeholder that relate to the trade shipment such as Trade Item ID (Product code/ID, Material code/ID), Sales Order ID, etcetera.			
All events and related data for each unique ID can be captured and cross-referenced for that particular operator and stakeholders of that mode of transport but can also be related to the Trade Shipment ID assigned by the Seller.			

Figure 3. Clarification of Terminology and Usage of standard Identifiers.

However, as stated above, during transportation, the consigned goods themselves may be removed and placed in another means of transport or transport equipment for onward movement. Their identifiers, if they are unique, make a particular piece of transport equipment, or a means of transport, a trackable transport asset.

Using 2D barcodes standardized according to Scan4Transport (see Appendix 1), sellers may make these transport assets IDs easily available to handling parties throughout the supply chain. This assumes those 2D barcodes would be visible to those handling parties. However, due to consolidation where the original transport units as created by the seller are merged into consolidated transport units, the 2D barcodes on the seller’s transport units are not always visible/scannable. This is an example that although there may be identifiers present, if the information is not communicated or captured, a disconnect may still result.

Standards development bodies have made in-roads to facilitate tracking by offering global data standard identifiers. ISO/IEC 15459-6:2014 specifies a unique string of characters for the identification of groupings of products, product packages (product packaging including the product), transport units and items. ISO 15459 part 1 provides a method to assign globally unambiguous Transport Unit IDs to the logistic packages (e.g., boxes) created at the origin when the seller despatched the goods independent of any carrier and independent of any shipper. This ISO standard is well over twenty years old and already in use in many parts of the supply chain and in transportation as well, but as yet has not been universally adopted. It enables consistent tracking (and tracing) of the individual transport unit and the trade shipment associated with it and associated consignments. Wider adoption of these foundational standards will greatly simplify achieving seamless tracking and tracing from Seller to Buyer.

Note. In general, it is highly recommended to use automated means to capture the identifiers in an efficient manner, avoiding human errors.

This BRS does not specifically address the detailed business relationships between all participants and their individual requirements for communications; however, it should be noted that the data elements, their business context, and identification as to which standards organization has defined these elements are already in the UN/CEFACT MMT-RDM. For many of those data elements global data standard identifiers such as those provided by ISO, GS1, and IMO are already available.

Overall general requirements are:

- To have visibility of the goods at any point in the movement from Seller to Buyer, or from Buyer to Seller if such goods are returned.
- Utilize existing data elements from the UN/CEFACT MMT-RDM in track and trace processes that can facilitate multi-modal visibility and interoperability.
- Continue to incorporate future data elements in the continuously evolving MMT-RDM, with identification of the related standards body which has adopted such for future use which may enhance and provide additional efficiency and visibility in logistics and supply chain processes.

5.2 Definitions of Business Terms

A list of Definitions of Business Terms can be found in Appendix 1.

5.3 Business Requirements View

5.3.1 Business Domain View- Business Areas, Process Areas, Business Processes

Elements of consignments to be considered in detailing the business areas, process areas and business processes depend on how they are related to the various mode(s) of transport and type of tracking used.

Figure 4 below illustrates the complex relationship of transport movement to many diverse functional areas (e.g. sustainability):

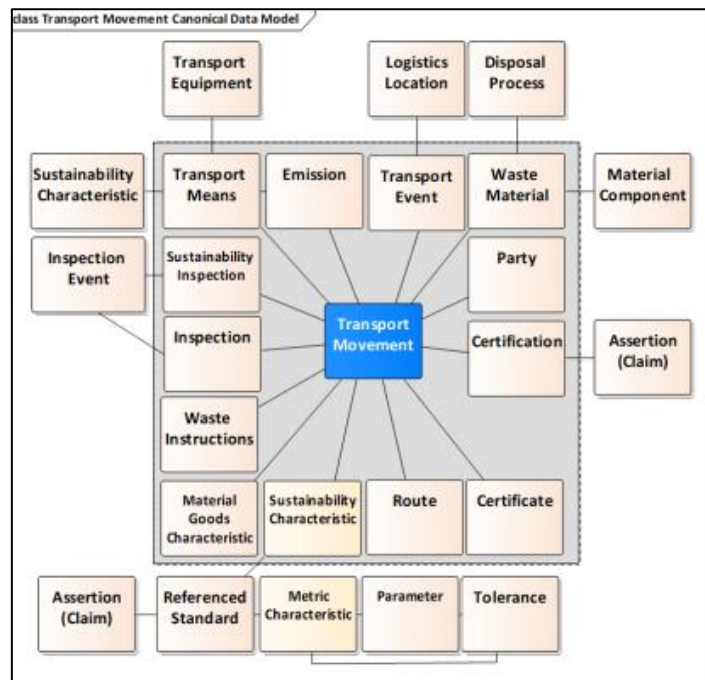

Figure 4. Transport Canonical Data Model;
Traceability and Transparency in the Textile and Leather Sector, Part 1:
High-Level Process and Data Model – Business Requirements Specification (BRS)

Business process areas are related to the transport phase for the consignments of the trade shipments related to a trade contract.

5.3.2 Business Partner View—Participants and Stakeholders

Any party with a stake in the transport of a consignment of goods through any mode of transport is a direct stakeholder. Other parties which have need of the results of tracking during transport, or tracing of the history of the transport are indirect parties.

Participating parties: There are potentially many parties participating in the cross-border international supply chain. These parties can be grouped into four main categories as indicated in Figure 5 below:

Sales order contract	Transport service contract	Definition
Seller	Original consignor/original shipper	The party selling goods or services as stipulated in a sales order contract.
Buyer	Final consignee/ultimate consignee	The party to whom goods are sold or services provided as stipulated in a sales order contract.
	Transport services buyer (consignor or consignee)	The buyer of transport services as stipulated in a transport service contract.
	Transport services provider (carrier or freight forwarder)	The provider i.e., seller of transport services as stipulated in a transport service contract.
	Consignor	The party consigning goods as stipulated in a transport service contract.

	Consignee	The party receiving a consignment of goods as stipulated in a transport service contract.
	Carrier	The party which provides transport services (a person or company that undertakes the professional conveyance of goods).
	Freight forwarder	The party undertaking the forwarding of goods by provision of transport, logistics, associated formalities services etc.
	Despatch party	The party where goods are collected or taken over by the transport services provider. Operational term is 'pick-up location' (or 'pick-up place').
	Delivery party	The party to which goods should be delivered by the transport services provider. Operational term is 'delivery location' (or 'drop-off location').
Ship from	Original Despatch party	The party from whom goods will be or have been originally shipped.
Ship to	Final delivery party/ultimate delivery party	The party to whom goods will be or have been ultimately shipped.

*Figure 5. Trade/Transport/Customs Party Roles; BUSINESS REQUIREMENTS SPECIFICATION (BRS)
BUY – SHIP – PAY Reference Data Model (BSP-RDM)
Approved: UN/CEFACT Bureau on 13 August 2019 Version: 1.0, p.12*

There are additional **Indirect stakeholders who may/may not request status information during tracking or for tracing:**

- Transport equipment owner (may or may not be the same as the Transport Operator)
- Communications equipment owner (may or may not be the same as the Transport Operator)
- Financial Institution (such as a bank)
- Insurance Agent
- Regulatory Agency
- Broker
- Public Authorities (Customs, Coast Guard, Police, etc.)
- Academy and Research Centers

5.3.3 Business Entity View– Entity States, Lifecycle and Conceptual Model

This section deals with the life cycle of the UN/CEFACT trade shipment between seller and buyer, (see Figure 6) and how that life cycle links to other UN/CEFACT concepts of Consignment, Transport Units and others (see Figure 7).

In this BRS, the UN/CEFACT trade shipment is the foundational concept upon which the structures described in this document are “built”. Transport service contracts are required to move the goods of the sales order contract from Seller to Buyer. Multiple transport service contracts between parties may be necessary for the goods to reach the ultimate destination of the buyer. The various transport service contracts all relate to the original sales order contract executed between the Seller and the Buyer.

The transport of goods/trade shipments between seller and buyer runs through several logical steps. The table below covers trade shipments that are relatively small and can be transported “packaged” in transport units of which several may be carried on a single transport means at the same time. The

vast majority of trade shipments (well over 90% and increasing due to the rapid rise of e-commerce) transported in the world today fall into this category.

Figure 6 below provides the description of the Trade Shipment Life Cycle, from Seller to Buyer:

Business Step	Description	Life Cycle State/s
Create Sales/Purchase Order	Seller and Buyer agree on trade transaction e.g., trade items, quantities, and pricing.	Trade transaction booked and agreed.
Pick and Pack Trade Items ³⁴	Put trade items in transport units readying them for transportation.	Trade Shipment created. Transport units created.
Load ³⁵ Trade Shipment	Load transport units onto transport means of first Logistic Service Provider at identified Location/Place.	Trade Shipment despatched and first Consignment created. Trade Shipment and Consignment "in transit"
Unload Consignment at LSP hub ³⁶	Unload the transport units from the transport means at identified Location/Place	Trade Shipment and Consignment "In Situ" in identified Location/Place
Consolidate Trade Shipments to Consignment	Combine transport units from multiple trade shipments to consignment for next transport movement. New transport units may be created in the process.	Trade Shipments consolidated to Consignment. Transport units created (if applicable).
Load consolidated consignment for next transport movement	Load transport units onto transport means of next Logistic Service Provider at identified Location/Place.	Consignment loaded. Trade Shipments and Consignment "In Transit"
Unload Consignment at next hub	Unload the transport units from the transport means at identified Location/Place	Trade Shipments and Consignment "In Situ" in identified Location/Place
De-consolidate Consignment.	Split out transport units for the combined multiple trade shipments and/or consignments from the consolidated transport units for next transport movement.	Trade Shipment and/or Consignment de-consolidated. Transport units "In Situ" in identified Location/Place
Create Consignment for next transport movement	Create new Consignment to manage next transport movement for de-consolidated trade shipments and/or consignments. New transport units may be created in the process.	Consignment created. Transport units created (if applicable). "In Situ" in identified Location/Place
Load consignment for next transport movement	Load transport units onto transport means of next Logistic Service Provider at identified Location/Place.	Consignment loaded. Trade Shipment and Consignment "In Transit"
Unload Consignment and its Trade Shipment(s) at Buyer's Location/Place	Unload the transport units from the transport means	Trade Shipment(s) contained in the Consignment "Delivered".

³⁴ Multiple trade transactions may be combined in a single trade shipment.

³⁵ This is also often called "Despatch".

³⁶ A hub is any transport & logistics network node where trade/transport units are stored as part of their seller to buyer journey.

Key to shading in Figure 6.

Rows with light green background indicate consolidation steps in the journey may be repeated.
Rows with light blue background indicate de -consolidation steps in the journey may be repeated.

Figure 6. Description of the Trade Shipment Life Cycle, from Seller to Buyer.

Both light green and light blue rows are **optional** steps in the process, e.g., a trade shipment may be transported directly from the Seller to the buyer on a single transport means and a single transport movement.

This BRS makes the point that we need to link the various identifiers used throughout the life cycle of the UN/CEFACT trade shipment (from Seller to Buyer) as part of the various activities (business steps) that are executed by different parties during the life cycle of those trade shipments.

Figure 7 below provides an overview for trade shipments transported as unitized cargo (i.e., packaged in boxes, on pallets, in intermodal containers, etc.)

Business Step	Identifiers linked/created
Create Sales/Purchase Order Contract	Create Sales Order ID / Purchase Order ID / Trade Shipment ID
Pick and Pack Trade Items	Link Trade Shipment ID to Trade Item IDs / Logistic Unit IDs / Transport Unit IDs
Load Trade Shipment	Link Transport Unit IDs / Consignment IDs / Transport Means ID
Unload Consignment at LSP hub	Un link Transport Means ID from Consignment IDs / Transport Unit IDs . Link Transport Unit IDs to Logistic Location ID (for the hub).
Consolidate Trade Shipments / Consignments	Link Transport Unit IDs to Transport Equipment ID and the consolidated Consignment IDs. NOTE: Transport Equipment IDs are also linked with the relevant consignment IDs
Load consolidated consignment for next transport movement	Link Transport Equipment ID to Transport Means ID NOTE: Knowing where the transport means is implies knowing where the trade items are. Un link the Logistic Location ID (for the hub) from the Transport Unit IDs
Unload Consignment at next hub	Un link Transport Means ID from Consignment IDs / Transport Unit IDs
De-consolidate Consignment.	Un link Transport Unit IDs from larger Consignment IDs.
Create Consignment/s for next transport movement	Link Transport Unit IDs to Consignment IDs.
Load Consignment for next transport movement	Link Transport Unit IDs / Consignment IDs / Transport Means ID
Unload Consignment / Trade Shipment at Buyer's Location/Place	Un link Transport Means ID from Consignment IDs / Transport Unit IDs . Link Transport Unit IDs to Logistic Location ID or Location/Place ID (for the buyer).
Confirmation of Delivery	The above unloading event may be used as Confirmation of Delivery. However, in most cases, the confirmation of delivery will be exchanged

	among stakeholders as explicit event. In those cases, confirmation of delivery will also include the Trade Shipment ID . And may include Trade Item IDs as well.
--	--

Figure 7. Linking global data identifiers at Trade Shipment Life Cycle Stages / Business Steps.

Figure 7 above represents (one of) the most common scenarios for trade shipments involving packaged Trade Items. As indicated in the 8-step approach for implementing EPCIS (see Appendix 3), stakeholders involved in a specific transport and logistics network should identify which of the above steps in the above life cycle and scenario apply for them. They may also need to repeat some of the business steps in their specific context.

However, using these business steps as building blocks, it should be feasible in nearly all Transport and Logistics networks to “map out” the specific context using these building blocks (only).

Appendix 4 provides more detail regarding each of these logical steps and the identifiers that may be used and linked in each of these steps to ensure all stakeholders involved find the tracking and tracing information they need to support their business processes.

The identifiers and especially the links created among these identifiers in the relevant business steps that will be accessible via a commonly used ecosystem will enable all stakeholders involved to always find and access the information associated with any of these related identifiers.

Figures 6 and 7 above (when “tailored” to the specific context) provide the sufficiently detailed common basis for the stakeholders involved to map/translate the required information capture and information exchanges in standardised ecosystems such as EPCIS and/or Linked Data that may be implemented alongside more traditional EDI information exchanges.

5.4 Business Choreography View

5.4.1 Business Transaction View-Transactions and Authorised Roles

The seller-to-buyer trade shipment approach has been modelled for multi-modal transportation by UN/CEFACT in the Buy-Ship-Pay (BSP) and Multi-Modal Transport (MMT) Reference Data Model.

We are now in a transition from older standards adopted by individual transport modes to the current efforts conducted by multiple international standards organizations to identify a normalized method of identification of required data that will be applicable to any seller-to-buyer trade shipment, regardless of the transport mode. Any authorized stakeholder to the transaction should be able to access the same data in near-real time in order to facilitate multi-modal transport and interoperability in the exchange of data across varying modes of transport platforms.

Business choreographies tend to be quite similar even though terminology for business steps, documents, objects and entities may be different across the modes of transport and also sometimes across sectors dealing with specific types of goods/trade items. The fact that the choreographies are similar is a key enabler for connecting the choreographies that currently exist only in specific modes or industry sectors. This BRS provides the starting points for seamlessly connecting these “siloes” choreographies in the main text as well as in the Appendices (2, 3, 4, 5, and 6) to establish the Cross Industry Track & Trace between Seller and Buyer that the beneficial cargo owners and other stakeholders need.

5.4.2 Business Collaboration View-Linked Transactions

The Data Pipeline concept has been defined and clarified by UN/CEFACT and provides normalized waypoints for any mode of transport of a consignment during its journey. (See Appendix 2 in this BRS document). The UN/CEFACT PDES (Pipeline Data Exchange Standards) currently focus on the transport aspect, but to a large extent do not address the trade transaction that drives the need for transportation in the first place.

The UN/CEFACT PDES BRS does provide for and emphasizes the importance of the timing of obtaining the movement information related to the consignments (transport service contracts) that are executed within the context of the sales order contract from Seller to Buyer.

This current Track and Trace project follows in-step with the UN/CEFACT PDES Business Requirements data elements already identified within the UN/CEFACT MMT-RDM. This BRS aims to extend the Data Pipeline concept to also cover the trade transaction aspects that are required to know where trade items (goods) are located at any point in time.

Please note that the UN/CEFACT PDES look at the life cycle of a single UN/CEFACT Consignment (even when that consignment is transported over multiple modes of transport). This Track & Trace BRS is focussed on the life cycle of the UN/CEFACT Trade Shipment, which may be transported in multiple different UN/CEFACT Consignments (as outlined in 5.3.3.). We call this extended concept “Shipment Data Pipeline” in this BRS to clearly distinguish it from the original Data Pipeline described in the PDES BRS.

5.4.3 Business Realization View-Business Partner Types and Authorized Roles

Transport service contracts are required to move the goods of the sales order contract from Seller to Buyer. Multiple transport service contracts between parties may be necessary for the goods to reach the ultimate destination of the buyer. The various transport service contracts all relate to the original sales order contract executed between the Seller and the Buyer.

Below are examples of transport service contracts that could be generated as a result of the sales order contract:

- Producer to Manufacturer
- Manufacturer to Buyer
- Manufacturer to Logistics Services Provider/Forwarder
- Logistics Services Provider/Forwarder to Carrier
- Carrier to Buyer (directly)
- Carrier to Carrier (intermodal case)
- Carrier to Logistics Services Provider/Forwarder
- Logistics Services Provider/Forwarder to Buyer

5.4.4 Business Realization View-Cooperation and Coordination between international standards bodies to enable interoperability

We are beginning to see standards and technology approaching one another to a point of closing the disconnect between trade identification and its transport identification – we are becoming aware that

digitalization is disruptive but is becoming more universally accepted and will allow us to solve many of the legacy problems of the 400-year-old trade system.

Depending on the mode of transport, there are currently many standards in place to accommodate the interchange of information concerning movement of goods. There are many international organizations which have provided unique standards and IDs for use in consignment transport including ISO, IMO, IATA, GS1, WCO, WTO, IRU, BIC, FIATA, DCSA, and IPCSA. This is by no means an exhaustive list. However, data standards adopted by such organizations are already consolidated within the UN/CEFACT MMT-RDM. As new standards are adopted and accepted, they can also be added to this global master database.

Traceable assets are key to identifying the movement of consignments, thus allowing the trade items to be located at any anticipated waypoint during the transportation chain. Each active stakeholder from every stage and mode in the chain can contribute to building the trace and visibility of the supply chain. Linkage of a trade shipment ID to the assets used during transport (consignment, means, equipment) is what closes the trade-transport gap. Events such as those used in the UN/CEFACT PDES project or those described by EPCIS as aggregation/disaggregation events are the waypoints and checkpoints where the anticipated timing and location of the consigned goods are either confirmed or realized and enable tracking and correction, if required.

UNCEFACT adopted the model of EPCIS, originally defined by GS1 (see Appendix 3), now accepted as well as an ISO standard, for traceability of textile and leather materials/products. UN/CEFACT used the concept behind the standard and profiled the standard to the needs of the textile industry. The coordination between these standards-creating bodies has further enabled the usage of these principles in the process of trace and trace. These standards are now also being used in combination with blockchain. The essence of this work is supply chain visibility using unique identifiers and for tracking the goods being produced and/or transported in any mode. When different modes of transport use the same standards, such as GS1 or UN/CEFACT, then they can exchange the data as they use the same type of event semantics and type of identifiers.

WCO investigated the possibility of using a Universal Consignment Reference Number (UCR) more than 10 years ago, which was not universally adopted. Although Customs organizations in individual Member States have started to adopt the GTIN (Global Trade Item Number) as part of their cross-border processes, this practice is not yet widely adopted by WCO Member States.

There is work currently being done by the U.S. Customs and Border Patrol (CBP)³⁷ to consider open standards for Customs reporting, using verified credentials and decentralized identifiers for the consignment and its movement, in other words, using whichever open (non-proprietary) standard is available, as long as the type of standard is identified.

The UN/CEFACT EDATA Management Domain group produced a draft White Paper entitled *VERIFIABLE CREDENTIALS FOR CROSS BORDER TRADE*.³⁸ This paper recommends standards guidelines regarding verifiable credentials. The approach may be one piece of the solution to future Track and Trace interoperability. “This paper describes a highly scalable operating model for digitalization and trust of cross border trade based on verifiable credentials, linked data, and decentralized identifiers. It provides national regulators with implementation guidance that will facilitate the following outcomes.

³⁷ UNCITRAL webinar, Current Work on a New International Instrument on Multimodal Transport Documents, José Angelo Estrella Faria, which included the U.S. Department of Homeland Security presentation on CBP Blockchain Initiatives, June 23, 2021.

³⁸ UN/CEFACT, EDATA Management Domain, Draft White Paper: *VERIFIABLE CREDENTIALS FOR CROSS BORDER TRADE*, December 2021.

- Full and rapid digitalization of all exports without any dependency on trading partner readiness. This is because the framework supports the seamless blend of human readable and digital data so that exporting nations can go 100% digital whilst their trading partner nations can adopt digital processes at their own pace.
- Traceability through the supply chain. By linking the export document and product labels to digital evidence created earlier in the supply chain, a linked data graph of verifiable documents is created. Importers & consumers can follow the links to verify that what is stated on the product label is true. [UN/CEFACT currently has a project in progress to provide the technical requirements for conformity that could be utilized to address the current disconnect with the trade shipment for Customs reporting, based upon the same principles referred to in this document.³⁹] Importing regulators can independently and digitally verify that their compliance criteria are met.
- Automated compliance and risk. As exports are increasingly digitized, so importing regulators can leverage the digital chain of trust to automate compliance assessments. This will reduce border costs for goods with strong digital credentials and improve risk targeting because border authorities can focus their efforts on imports with lower or unknown trust. Similarly, banks can automate their risk assessments and consequently lower the costs of trade finance, allowing small exporters to compete on more equal terms with their larger competitors.”

The COVID-19 pandemic accelerated the adoption of digital technologies by businesses around the world, but significant barriers continue to prevent the full digitalization of trade-related processes.⁴⁰

2022 has been an extraordinary year in terms of landmark reports and strategies to address global supply chain digitalization. Recent reports, including a joint report by the World Trade Organisation (WTO) and the World Economic Forum, *The Promise of Tradetech – Policy Approaches to Harness Trade Digitalization* and a WTO/ International Chamber of Commerce (ICC) publication, *Standards Toolkit for Cross-border Paperless Trade* are especially important resources.⁴¹

The Joint WTO/WEF joint paper identified in the previous paragraph, has stated that, “The COVID-19 pandemic has shown that digital trade and commerce has become a staple for survival for small and medium-sized enterprises all over the world, while the application of autonomous technologies – from robotics to artificial intelligence – have contributed to the operation of ports and warehouses with minimal staffing during lockdowns. According to a World Economic Forum business survey, the adoption of TradeTech – the set of technologies that enables global trade to become more efficient, inclusive and sustainable – has helped to ease supply chain bottlenecks across different industries. For parties to seamlessly exchange electronic data and documents in a digital environment, all information needs to be clearly defined and unambiguous. Reaching agreement on both the semantic content (i.e. data definitions) and the syntax of data (i.e. data structure or format) is critical to ensure trading partners wanting to exchange information all understand the information in the same way. It is critical to ensure interoperability between platforms as well. Various platforms being developed, be they private-sector-driven in areas such as trade finance, transportation or national single windows (NSWs), follow their own rules and still often operate in isolation. Building bridges between the various platforms or developing common cross-sectoral or cross-jurisdictional approaches is needed to enable global flows of electronic data and documents. Governments could leverage trade agreements to promote the use of existing semantic libraries, support the development and interoperability of data models for trade documents, and encourage interoperability of single windows. Both the United Nations Centre for Trade Facilitation and Electronic Business (UN/CEFACT) and the World Customs Organization (WCO) have developed semantic libraries (“what means what”). Priority now needs to

³⁹ <https://uncefact.unece.org/display/uncefactpublic/Digital+Product+Conformity+Certificate+Exchange>.

⁴⁰ Ibid.

⁴¹ Brett Hyland, NATA, Round Table Communique, 13 May, 2022.

focus on promoting a much wider use of these existing semantic libraries to reach a critical mass of users.⁴² This Joint WTO/WEF document is focused on Trade documents, however, the transportation of the goods of trade is an important part of this discussion and the focus of this UN/CEFACT BRS.

The International Chamber of Commerce also published a Standards Toolkit for Cross-Border Paperless Trade in 2022.⁴³ This is a joint publication by the ICC Digital Standards Initiative and the World Trade Organization. The ICC Digital Standards Initiative (DSI) was developed to embed the seamless digitalization of processes throughout the global trading system. This project was supported by the Asian Development Bank and the Singapore Government to help solve for the key barriers hindering trade digitalization. The publication lists many relevant trade organizations and provides references and description of the areas of specialization and standards they have adopted.

In current and future tracking and tracing, we cannot be interested only in the physical goods, but also it is necessary to consider the conformity criteria of the goods for security purposes and sustainable development goals. In February 2022, several organizations in Australia published their views in *Digitalisation of Conformance and Accreditation Processes, based on ISO Global Data standards*.⁴⁴ In the paper, they stated, “The rapid transition of global supply chains to data-driven, digital systems is placing new and increasing pressures on product conformity systems, their relevance, and the ability to deliver benefit through international trade income growth and the economic wellbeing of people. There is a growing gap between digital product traceability and the traceability of associated product conformity and credentialing information. Efforts to simplify trade systems require that the national product conformity infrastructure and supporting systems are responsive and of high integrity – enabling rapid verification of credentials and detection of fraudulent or erroneous claims.”

Further to this effort, NATA, JAS-ANZ and GS1 Australia published a draft paper⁴⁵, that discusses an optional framework that can be adopted by Governments, that utilizes multiple international standards. As stated in this paper, “The common factor among these challenges is the absence of a standardized framework for the digitalization of conformance and accreditation processes – including the necessary information architecture and common language to identify, capture and share data of relevance to national product conformance.

This paper puts forward a broad framework (‘the framework’), a general structure aligned with global data standards that can accommodate different supporting technologies (for example, blockchain, non-fungible tokens or verifiable credentials).

The objective of the proposed framework is simply to move to an approach based on global data standards to deliver international alignment, harmonization, and interoperability, that leverages the existing data standards used by industry for product traceability.

The framework provides an industry pathway to potential future states, including open attestation systems that are less reliant on central registries. In doing so, credential holders could have greater control over information disclosures than is currently possible.

Data exchange standardization for conformance and accreditation processes will assist in closing the gap between physical product and product conformity data flow. It will help align conformity

⁴² WTO and WEF, *The Promise of Tradetech - Policy Approaches to Harness Trade Digitalization*, 12 April, 2022.

⁴³ Ganne, Emmanuelle (WTO) and Nguyen, Hannah (ICCDISI), ICC and WTO Standards Toolkit for Cross-border Paperless Trade - ICC - International Chamber of Commerce, 2022.

⁴⁴ NATA, JAS-ANZ, and GS1 Australia, *Draft Paper: Credentials, Claims and Credentials Exchange for Enhanced Digital Product Conformity*, March 2022. See also: <https://uncefact.unece.org/display/uncefactpublic/Digital+Product+Conformity+Certificate+Exchange>.

⁴⁵ NATA, JAS-ANZ, and GS1 Australia, *Draft Paper: Credentials, Claims and Credentials Exchange for Enhanced Digital Product Conformity*, March 2022.

infrastructures everywhere with evolving supply chain traceability systems.” This paper puts forth a similar approach that is now being recommended by UN/CEFACT in this BRS for Track and Trace.

Furthermore, there are several logical links between Events occurring during the execution of transportation and the validity of the product conformity certifications. For example, certification of a temperature-controlled product may have been determined prior to transportation but that certification would no longer be valid if the temperature of the product during ground handling or transportation was outside set limits for an extended period of time. This means that the means for exchanging Events information should be interoperable across these two UN/CEFACT projects.

**The main question to answer for Tracking and Tracing from Seller to Buyer is
“How do we enable the Trade Parties to have visibility across all the transport movements,
unless the primary identification in the Sales Order Contract is also carried
throughout the related transportation (sub-)contracts?”**

It is envisioned for future operational and systems interoperability and communications between seller and buyer, that a combination of such standards will be needed to close the communications gap regarding movement of the sales order contract items. A key requirement to be able to close this disconnect will be the adoption of commonly used global data standard identifiers for objects and entities and linking those identifiers unambiguously in a commonly used environment for the exchange of track and trace information.

**At present, the requirements needed and means to closing the trade-transport gap are already recognized and the data elements and business context required in communications needed for multi-modal or intermodal transport are already included in the UN/CEFACT MMT-RDM.
All identifiers required for this purpose are also readily available from well-established standardization organizations.
This also applies to the means to exchange the relevant track and trace event information.**

Documents published by UNECE, the parent body of UNCEFACT can be found online, as in Figure 8 below:

UN/CEFACT – Where to find documents

<https://unece.org/trade/uncefact/mainstandards>

Figure 8. UNECE/UN/CEFACT Standards Documents Availability on-line

Also, see Appendix 4 in this BRS document, Coordination between UN/CEFACT and Other Industry Standards Organizations.

In light of the above, UN/CEFACT recommends the following:

- All public and private sector supply chain actors should prioritize mnemonic and codified data instead of textual inputs, and reference whenever possible freely available code lists like those maintained by UN/CEFACT.
- All public and private sector supply chain actors should carefully consider the semantic meaning of data when establishing electronic data exchange, taking into consideration the guidelines accompanying this recommendation and keep transparent record of these.
- All electronic business dematerialization efforts of data should be harmonized in a holistic approach of the international supply chain.
- All public and private sector supply chain actors should consider using UN/CEFACT semantic standards either as the base of their electronic exchanges, as a reference in the message structures or as a mapping to facilitate interoperability.
- Should any semantic needs or code lists not be defined within UN/CEFACT, the stakeholders which identified this lack are encouraged to bring these as a project within UN/CEFACT to fully cover any potential semantic needs or code lists useful to international trade.

UN/CEFACT standards are about semantics, not about the particular technological implementation to be used. It is the singular global standards organization that develops its standards in Buy-Ship-Pay and the related MMT-RDM to be applicable regardless of mode of transport and includes the standards of other international standards organizations within its databases. Thus, it provides the basis for communications to facilitate intermodal systems interoperability.

The experts working on this BRS also highly recommend the following to facilitate collaboration and interoperability among stakeholders in supply chains:

- **Use global data standard identifiers for objects and entities, if available, or collaborate for creation if not available.**
- **Use global data exchange means that enable “connect once, communicate with many” where feasible.**

A series of Appendices in this document are found below. These provide more detailed business context and technical reference information for track and trace. It will be necessary to coordinate the utilization of already existing international standards developed by UN/CEFACT with those of other international standards organizations in order to achieve the goal of multi-modal transport operational and systems interoperability for the future.

LIST OF FIGURES

Main Body of BRS:

Figure 1. Sample supply chain requiring track & trace for trade shipments from seller to buyer of goods

Figure 2. Understanding the difference between the shipment (trade view) and the consignment (transport view).

Figure 3. Clarification of Terminology and Usage of standard Identifiers.

Figure 4. Transport Canonical Data Model; Traceability and Transparency in the Textile and Leather Sector, Part 1: High-Level Process and Data Model – Business Requirements Specification (BRS)

Figure 5. Trade/Transport/Customs Party Roles; BUSINESS REQUIREMENTS SPECIFICATION (BRS) BUY – SHIP – PAY Reference Data Model (BSP-RDM) Approved: UN/CEFACT Bureau on 13 August 2019 Version: 1.0, p.12

Figure 6. Description of the Trade Shipment Life Cycle, from Seller to Buyer

Figure 7. Linking global data identifiers at Trade Shipment Life Cycle Stages / Business Steps.

Figure 8. UNECE/UN/CEFACT Standards Documents Availability on-line

Appendix 2:

Figure 9. Key Waypoints for a multimodal transport; DATA PIPELINE CARRIER PIPELINE DATA EXCHANGE STRUCTURE (PDES, Business Requirement Specification (BRS)

Figure 10. Trade Shipment Data Pipeline, Key Waypoints for a multimodal Shipment from Seller (collection) to Buyer (delivery)

Figure 11. Key Trade Shipment Life Cycle Stages, modified from DATA PIPELINE CARRIER PIPELINE DATA EXCHANGE STRUCTURE (PDES, Business Requirement Specification (BRS)

Figure 12. Trade Shipment Data Pipeline Data Sources, Data Providers, and Data Consumers, modified from DATA PIPELINE CARRIER PIPELINE DATA EXCHANGE STRUCTURE (PDES, Business Requirement Specification (BRS)

Figure 13. PDES example of potential Business Transaction Activity Diagram, DATA PIPELINE CARRIER PIPELINE DATA EXCHANGE STRUCTURE (PDES, Business Requirement Specification (BRS)

Figure 14. PDES example of Business Collaboration Activity Diagram, DATA PIPELINE CARRIER PIPELINE DATA EXCHANGE STRUCTURE (PDES, Business Requirement Specification (BRS)

Appendix 3:

Figure 15. GS1 Standards; GS1

Figure 16. Sample supply chain between Seller and Buyer; GS1

Figure 17. Typical TI and TS message exchanges involved for a single freight consignment; Source: GS1 Australia, 2020 – Freight Data Exchange Pilot Project – Summary Report

Appendix 4:

Figure 18. Disconnects in linking IDs between Trade and Transport; UN/CEFACT and GS1

Figure 19. ID Disconnects in multi-modal transport cases.

Figure 20. Combining global standards to solve the ID disconnect problem; UNECE/GS1

Figure 21. IFTSTA based model – ID Disconnects remain when multi-modal transport is involved; UN/EDIFACT IFTSTA

Figure 22. EPCIS standard overview; GS1

Figure 23. Linking trade items to logistic units - Packing; GS1

Figure 24. Linking logistic units to transport units; GS1

Figure 25. Consolidating consignments; GS1

Figure 26. Loading consignments on transport means; GS1

Figure 27. Unloading transport units from transport means; GS1

Figure 28. De-consolidating consignments; GS1

Figure 29. Splitting a Trade Shipment in Multiple Consignments; GS1

Figure 30. Alignment of other organization standards with those by UN/CEFACT; ICAO-UNECE Meeting of Experts on Supply Chain Digitalization Collaboration, 20 January 2021

Appendix 5:

Figure 31. Scope and purpose of track and trace applications; UNECE/UN/CEFACT INTEGRATED TRACK AND TRACE FOR MULTI-MODAL TRANSPORTATION, WHITE PAPER, 20 April 2021

Figure 32. First linear barcode on consumer products ever scanned at a point of sale; GS1

Figure 33. 2-D Barcode example; GS1

Appendix 6:

Figure 34. Bulk Transport Flow of Goods for Dry Bulk

Figure 35. Bulk Transport Flow of Goods for Break-Bulk

APPENDIX 1

Definitions of Business Terms:

- **Cargo** are goods carried on a transport means, such as a vessel, aircraft, or motor vehicle (such as a truck, train).
- **Consignment** is a separately identifiable collection of consignment items to be transported or available to be transported from one consignor to one consignee in a supply chain via one or more modes of transport, where each consignment is the subject of one single transport service contract.
- **Consignment Item** is an item within a consignment of goods separately identified for transport and customs purposes.
- **Goods** are any collection of traded (physical) items involved in a sales order contract that are collected together to form trade shipment(s) also known as trade deliveries (anything from produce, raw materials, semi-finished products to final products).
- **Intermodal Tracking** is a process that facilitates tracking when multiple modes of transport are used for a single sales order contract of goods transported from seller to buyer, but a separate transport service contract is required for each mode of transport used in the journey.
- **Location of goods** is the physical location of the consigned goods in whichever transport equipment, transport means or transport network hub they are at a moment in time during transportation, such as in-flight / in-warehouse. This is particularly important when the trade shipment may have been separated into different transport equipment or on different transport means for efficiency of transport movements.
- **Logistic Package** is a self-contained wrapping or container within which goods can be contained for logistics purposes, such as a box or a barrel which can be filled, partially filled or empty (part of the trade shipment).
- **Logistic Services** means all services from the beginning of the manufacture of the Product until the physical delivery of the Product to specified destinations, including the storage, order processing, handling and the arranging of transport as well as monitoring and managing the execution of transportation.
- **Logistic Unit** is an item of any composition established for transport and/or storage, which needs to be managed through the supply chain. It is a combination of a logistics carrier, such as a pallet, with the products contained therein. Logistic units take many forms, a single box containing a limited number of products, a pallet of multiple products, or an intermodal container containing multiple pallets. The term “Logistic Unit” is more often used in the trade domain whereas its synonym “Transport Unit” is reserved for the transport domain.
- **Logistics Services Buyer (LSB)** is any entity, which uses (buys) logistics services provided by logistics services providers (LSP) under the terms of a transport service contract.
- **Logistics Services Provider (LSP)** is any entity, which provides logistics services to a logistics services buyer (LSB) under the terms of a transport service contract. Beyond simple arrangement for transport, logistics service may include a number of additional support functions, such as readying the trade shipment for transport, making payments to the transport companies, providing communications to other parties, etc.
- **Movement of goods** is the conveyance (physical carriage) of goods or other objects used for logistics transport purposes.
- **Movement of transport means** is the conveyance (physical carriage) of goods or other objects by a transport means.

- **Multi-modal tracking** is a methodology that accommodates tracking on multiple modes of transport using a single or multiple transport service contract/s.
 - **Near-Real Time** is pertaining to the timeliness of data or information which has been delayed by the time required for electronic communication and automatic data processing. This implies that there are no significant delays. (Also called NRT).
 - **Product Packaging** is the wrapping material around a consumer item that serves to contain, identify, describe, protect, display, promote and otherwise make the product marketable and keep it clean.
 - **Real Time** is pertaining to the timeliness of data or information which has been delayed only by the time required for electronic communication. This implies that there are no noticeable delays.
 - **Reusable Transport Items (RTIs)** are all means to assemble goods for transportation, storage, handling and product protection in the supply chain, which are returned for further use, e.g., pallets, reusable crates, trays, boxes, roll pallets, barrels, trolleys, pallet collars, lids etc., (IC-RTI, 2003).
 - **Sales Order Contract** is an agreement between two or more parties, especially one that is written or spoken and enforceable by law.
 - **Tracing** is the function of retrieving information concerning traded goods, goods items, trade shipments, consignments, transport means or transport equipment. In the context of this paper, it is the monitoring of the history of the transportation of traded goods from seller (original consignor) to buyer (final consignee).
 - **Trackable transport asset** is an identifiable transport means / transport equipment / transport unit in which goods have been placed. Any trackable transport asset has a unique identifier.
 - **Tracking** is the monitoring of the present location and status of the goods while in transit.
 - **Trade Shipment** is an identifiable collection of one or more traded (physical) items (available to be) transported together from the seller (original consignor) to the buyer (final/ultimate consignee). Also known as a trade delivery. A trade shipment is related to a sales order contract of physical goods. In the transport domain, one or more trade shipments can be part of a consignment.
 - **Transport equipment** is a piece of equipment used to hold, protect or secure cargo for logistics purposes, e.g., intermodal containers, unit load devices, rail wagons, trolleys and roll-cages.
 - **Transport means** is the powered device used to convey people, cargo, animals or other objects from place to place.
 - **Transport operator** is a company, which provides any transport means to move cargo.
 - **Transport Service Contract** is a contract specifying a separately identifiable collection of consignment Items transported from one consignor to one consignee via one or more modes of transport.
 - **Transport service** is a service for moving people or goods. In the context of this BRS we focus exclusive on the movement of goods.
 - **Transport unit** is a unit intended for transportation comprising one or more traded items or trade shipments, wrapped or unwrapped.
- Unique identifier** is a unique, non-significant number or code.

APPENDIX 2

Pipeline Data Exchange Standards (PDES), further detail:

The Data Pipeline concept has been defined and clarified by UN/CEFACT and provides normalized waypoints for a trade shipment during its transport as a consignment during its journey. Below are Key Waypoints for the Data Pipeline. Depending where one is currently within the transport chain, there are certain types of actors who facilitate the process of operational movement and require information regarding the consignment.

The users of the information at each waypoint can be varied depending on their business needs of the data. Furthermore, the various input and output waypoints may vary depending on the needs of the business partners and the mode of transport.

Figure 9 below shows Key Waypoints for the current Data Pipeline concept as it relates to the UN/CEFACT consignment.

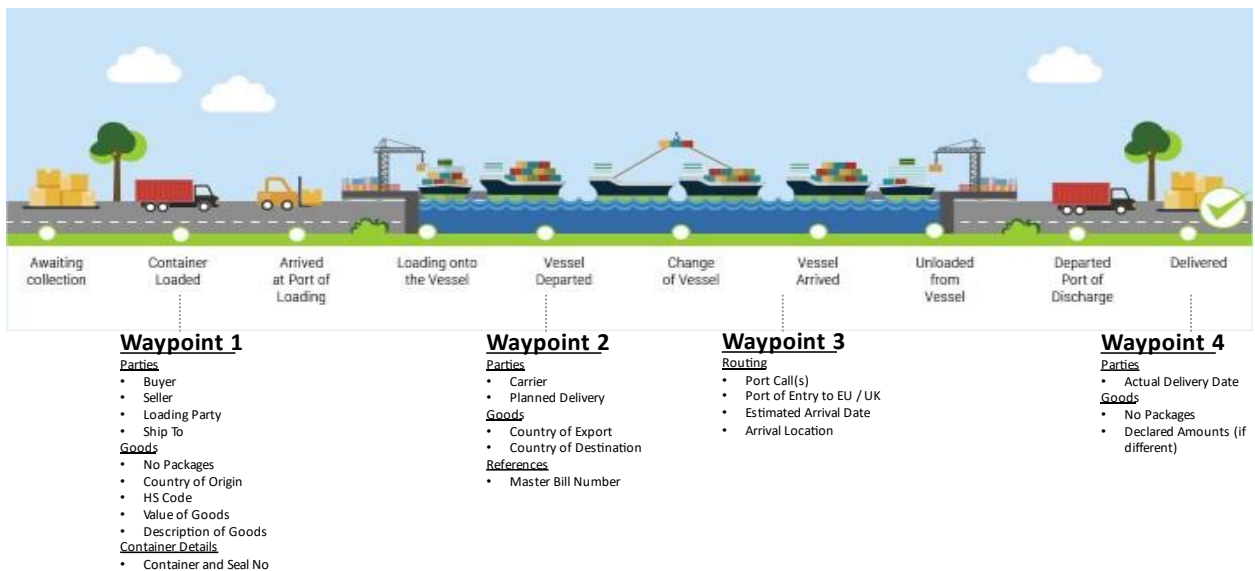

Figure 9. Key Waypoints for a multimodal transport, DATA PIPELINE CARRIER PIPELINE DATA EXCHANGE STRUCTURE (PDES, Business Requirement Specification (BRS))

The top half of Figure 9 (and details listed under Waypoint 1) reiterates that the entire transportation process starts with a trade transaction between a seller and a buyer of goods (trade items). These trade items are then prepared for transportation (becoming a trade shipment moved as a consignment in UN/CEFACT terms). This trade shipment moved as a consignment awaits collection to start on its journey to the buyer’s choice of destination.

NOTE: Within the context of the Shipment Data Pipeline the word “container” in Figure 9 above is to be understood as any transport unit containing goods involved in the trade shipment (a.k.a. trade delivery which relates to the trade transaction).

The transportation of a trade shipment typically progresses through three stages:

1. Pre-carriage.
Transport movements to move goods from seller's location/place to a logistic services hub that is the starting point for the main (long-haul) carriage of the goods.
2. Main carriage.
Transport movements that cover most of the distance travelled for the goods transported between seller and buyer.
3. Onward carriage.
Transport movements to move goods from a logistic services hub that is the end point for the main (long-haul) carriage of the goods to the buyer's destination.

As indicated above, the journey from seller to buyer may consist of a single direct transport movement from seller's location/place to buyer's location/place. Below, we will focus on transportation that involves the three stages above. With the addition of the above concepts related to UN/CEFACT trade shipments we may depict the Shipment Data Pipeline as in Figure 10 below.

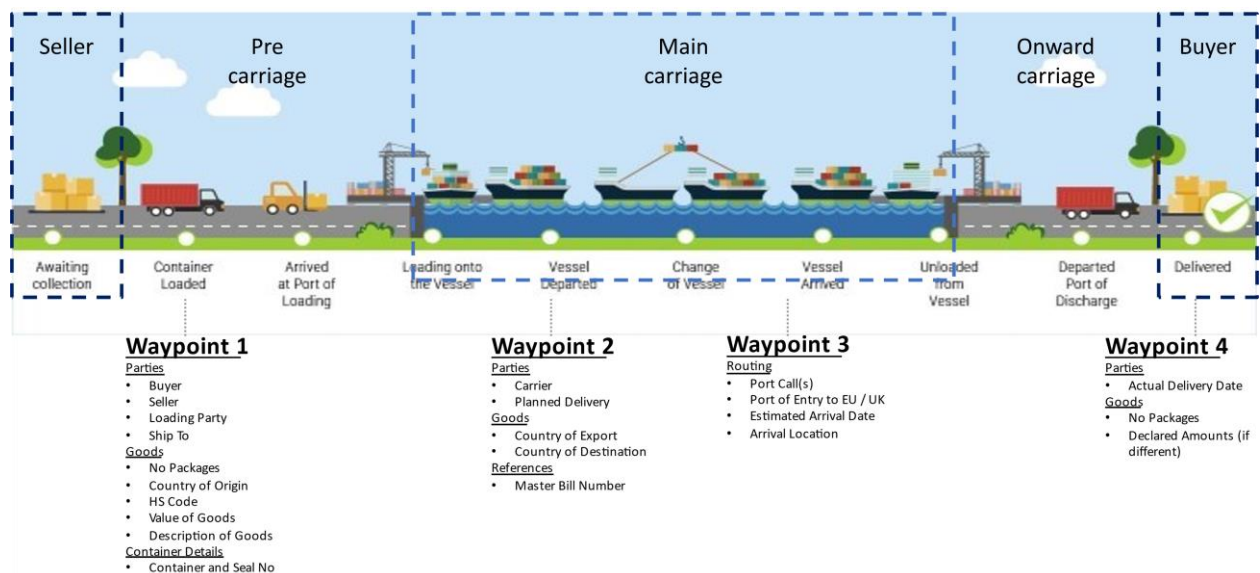

Figure 10. Trade Shipment Data Pipeline, Key Waypoints for a multi-modal Trade Shipment from Seller (collection) to Buyer (delivery)

There may be multiple transport movements as well as multiple LSP and transport service contracts involved in each of the three stages. Any mode of transport may be applicable in any of the three stages. Figure 10 depicts maritime mode merely as an example⁴⁶.

The users of the information at each waypoint may vary depending on their business needs of the data. Furthermore, the various input and output waypoints may vary depending on the needs of the business partners and the mode of transport. The Shipment Data Pipeline figure illustrates most of the common actors, objects, entities, data-elements, and identifiers involved in the transport processes that are the main focus of this BRS.

This BRS and the appendices will add guidance on how the seller and the buyer may provide valuable additional input into the Shipment Data Pipeline and also how this extended Data Pipeline may

⁴⁶ Maritime transportation covers over two thirds of all transportation on any mode of transport over any distance anywhere in the world measured in tonne-kilometres (International Transport Forum report).

provide valuable additional (track and trace) information to the seller and buyer (who are the beneficial cargo owners).

Key Trade Shipment Data Pipeline business requirements for timely reporting are identified in Figure 11 below:

Way point	Business Requirement Statement	Business Transaction Name
1	The point that the goods (Shipment) are physically loaded into a container, a unit load device (ULD) or into the packaging for transport. The Consignor or Transport Service Provider should have all information concerning the commercial aspects of the goods and the scheduled transport.	Shipment creation. Start pre-carriage.
2	The point at which the goods have departed from the logistic services hub where main carriage starts, confirming the main carriage transportation has started. The Transport Service Provider should have all information concerning the actual transportation. This information can be transmitted to the Seller, Consignee or Buyer (as well as to Regulatory Agencies in the country of arrival, if applicable) so they may prepare for the arrival of the goods.	Start main carriage.
3	The point at which the goods have arrived at the logistic services hub where main carriage completes, confirming the main carriage transportation has completed. The Transport Service Provider should have all information concerning the actual transportation. This information can be transmitted to the Seller, Consignee or Buyer so they may prepare and execute onward carriage of the goods. If applicable, this is also the point at which the required customs declaration for the arrival of the goods generally takes place. The declaration information may be transmitted directly to the relevant Regulatory Agency or alternatively to the declarant who uses the information for these regulatory procedures.	Complete main carriage transport
4	Goods have completed main carriage and are now ready to be transported to the final recipient (Buyer). There are no more physical or administrative obstacles to starting transportation to complete the trade shipment delivery process.	Start onward carriage.
5	The point at which the trade shipment is delivered to the Buyer. The information can be transmitted to the Transport Service Provider or the Seller.	Delivery of Trade Shipment

Figure 11. Key Trade Shipment life cycle stages;
extended from DATA PIPELINE CARRIER PIPELINE DATA EXCHANGE STRUCTURE (PDES)
Business Requirement Specification (BRS)

Figure 12 below (building on the Data Pipeline concept) provides an overview of key data sources to enable an effective Data Pipeline for the exchange of information among stakeholders involved in the journey of goods / trade shipments from seller to buyer. It merges the life cycle for the trade shipment outlined in this BRS, section 5.3.3. with the UN/CEFACT Data Pipeline standard.

Data Source	Data Provider	Data Consumer/s
Sell/Buy transaction	Seller / Buyer	
Shipment information e.g., transport unit data.	Seller's warehouse management system	All stakeholders
Shipment booking information	Seller's transport management system	First Transport Service Provider
Transport service contract for shipment (first Consignment)	Seller's transport management system	First Transport Service Provider
Shipment loaded for transport	First Transport Service Provider	Buyer
Shipment arrived next hub	Transport Service Provider	Seller
Shipment consolidated into new consignment (transport service contract)	Transport Service Provider	Seller
Consolidated Consignment departed from hub	Transport Service Provider	Seller
Consolidated Consignment arrived at next hub	Transport Service Provider	Seller
Export clearance achieved	Export Declarant	Seller, Buyer, Transport Service Provider (if not the Declarant)
Goods/Shipment started main carriage	Transport Service Provider	Seller, Buyer, Import Declarant (if applicable)
Transshipment or transit info	Transport Service Provider	
Transfer between transport means (e.g., vessel to vessel or road vehicle to road vehicle)	Transport Service Provider	
Main carriage Completed	Transport Service Provider	Seller, Buyer, Import Declarant (if applicable)
Import clearance achieved	Import Declarant	Seller, Buyer, Transport Service Provider (if not the Declarant)
Consolidated consignment split for next transport movement	Transport Service Provider	Seller
Onward carriage started	Transport Service Provider	Seller, Buyer
De-consolidated Consignment departed from hub	Transport Service Provider	Seller, Buyer
De-consolidated Consignment arrived at next hub	Transport Service Provider	Seller
Shipment/Goods delivered		

Key to Figure 12

Business steps with light blue background may not be applicable. However, they may also occur several times in the shipments journey.

Business steps with sand color background may not be applicable.

Figure 12. Trade Shipment Data Pipeline Data Sources, Data Providers, and Data Consumers; extended from DATA PIPELINE CARRIER PIPELINE DATA EXCHANGE STRUCTURE (PDES) Business Requirement Specification (BRS)

NOTE 1: Several different Transport Service Providers may be involved in the above trade shipment journey. Figure 12 uses “Transport Service Provider” as generic reference to any of them.

NOTE 2: Transport units of any size or shape may be equipped with smart sensors, which may be connected to the Internet. These so-called IoT (Internet of Things) devices may provide alerts in case criteria are met. Criteria may include “door/unit opened”, temperature limit exceeded, or “shock” detected. More information on this is available in the BUSINESS REQUIREMENTS SPECIFICATION (BRS) - Smart Containers. Approved: UN/CEFACT Bureau on 30 September 2019 Version: 1.0⁴⁷.

The relationship of Source of the data elements to the waypoints and possible business transactions required is illustrated in Figure 13.

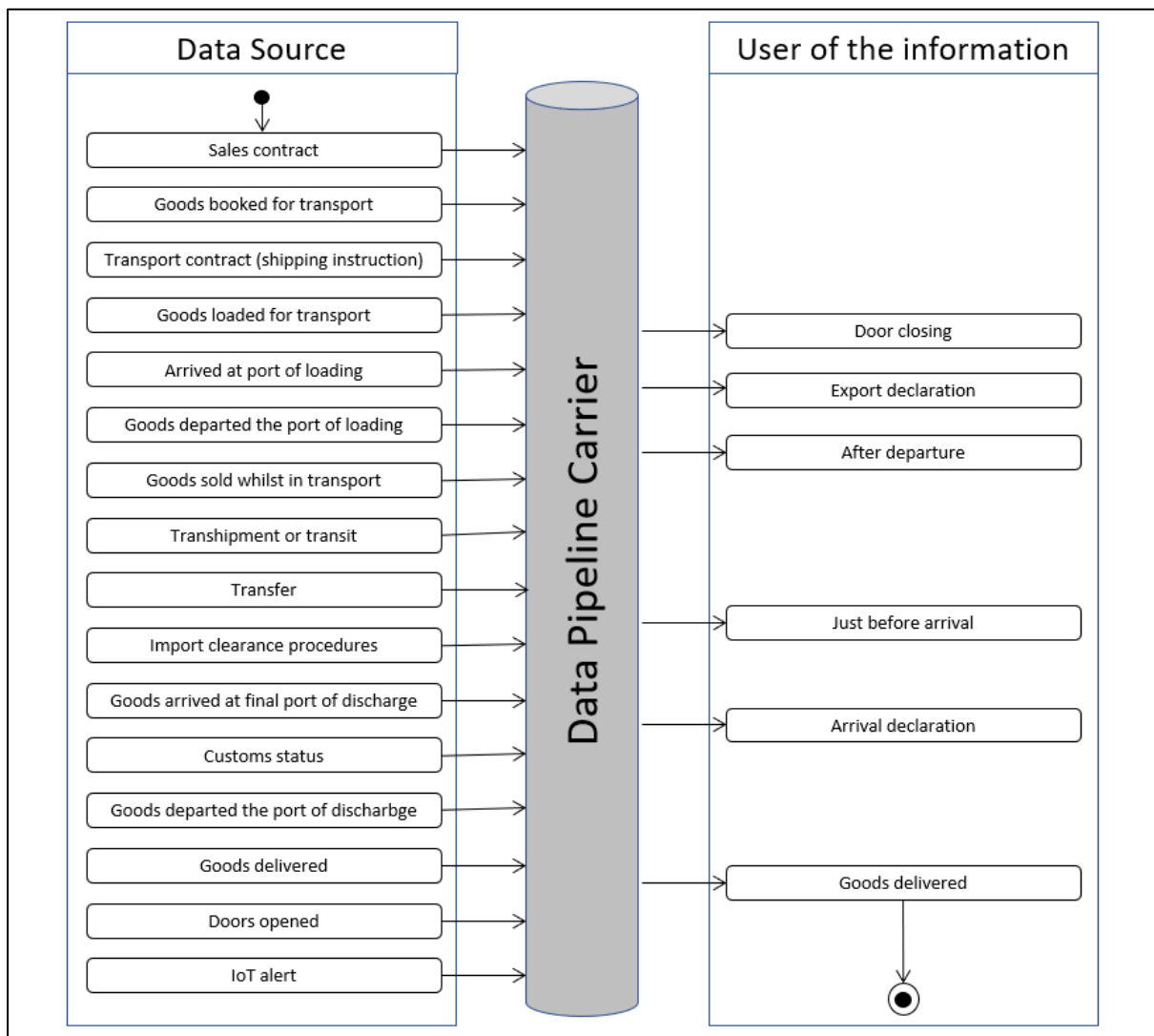

Figure 13. PDES example of potential Business Transaction Activity Diagram;
DATA PIPELINE CARRIER PIPELINE DATA EXCHANGE STRUCTURE (PDES),
Business Requirement Specification (BRS)

⁴⁷ BRS available for download at: https://unece.org/DAM/cefact/brs/BRS-SmartContainer_v1.0.pdf.

Further elaboration identifying the users involved and their relationship to the business transactions is illustrated by Figure 14.

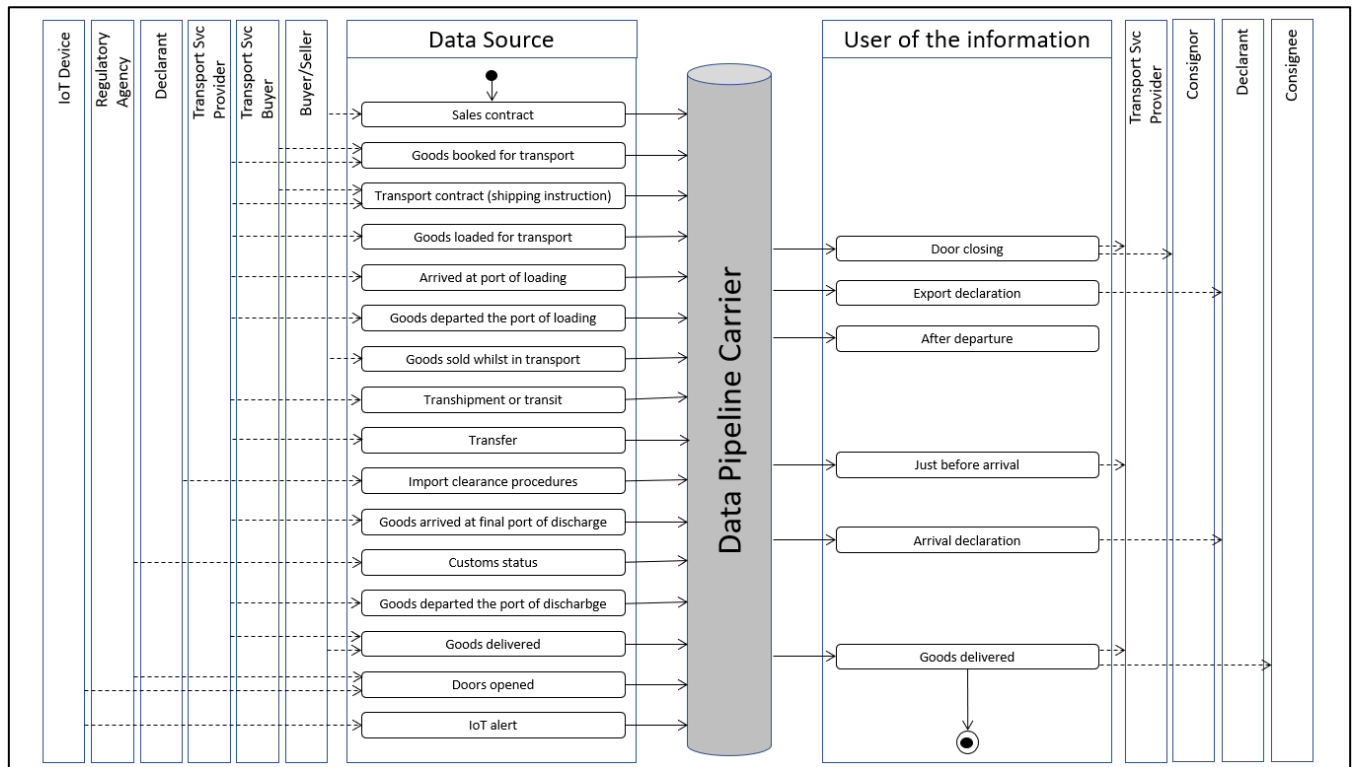

Figure 14. PDES example of Business Collaboration Activity Diagram;
 DATA PIPELINE CARRIER PIPELINE DATA EXCHANGE STRUCTURE (PDES),
 Business Requirement Specification (BRS)

APPENDIX 3

The GS1 system of standards and EPCIS, further detail:

Standards development bodies have made in-roads to address tracking. ISO standard 15459-1 provides a method to assign globally unambiguous Transport Unit IDs to the logistic packages (e.g. boxes) created at source when the seller despatched the goods independent of any carrier and independent of any shipper. This standard is well over twenty years old and already in use in many parts of the supply chain and in transportation as well, but as yet has not been universally adopted. It enables consistent tracking and tracing of the individual transport unit as well as associated consignments.

Similarly, the ISO standard 15459-6 provides a method to identify the Trade Shipment in a globally unambiguous way. The European Commission Customs Guidelines for compliance with the new EU VAT Ecommerce regulations also reference this approach. Numerous supply chains have implemented this approach quite successfully. In many cases, it meets the requirements of both cargo owners and authorities. However, the approach does not meet all business or regulatory requirements in all cases.

Ratification of the Electronic Product Code Information Services standard (EPCIS) by EPCglobal in 2007 (current version 2 published by GS1 in July 2022) paves the way for Supply Chain-wide event-based object traceability applications for use by Supply Chain partners with relevant product information readily available for the consumer. Event Processing (EP) mechanisms and approaches, i.e., event condition action, stream or complex EP, coupled with an influx of event data along Supply Chain (e.g., produced by RFID readers, temperature data loggers, shock sensors, etc.) enable the implementation of solutions utilizing interfaces with business intelligence, business activity monitoring, and risk management applications.⁴⁸ EPCIS events may be linked to any uniquely identifiable object or entity, so it may be used for tracking and tracing across trade shipments as well as consignments in which they may be contained.

GS1 published the [EPCIS and CBV Implementation guideline](#) on how stakeholders may approach designing and developing the Event Processing solution that is most appropriate for their business needs based on the EPCIS standards. This guideline recommends an 8-step process outlined below:

1. Collect visibility goals and requirements
2. Document business process flows
3. Break each process flow into series of discrete steps
4. Decide which business steps require visibility events
5. Model completion of each step as a visibility event
6. Decide which data to include in the visibility event
7. Determine vocabularies to populate each data field
8. Document visibility events in a visibility matrix

In addition to the above, GS1 published a [guideline](#) updated in 2017 providing recommendations on how to use the various useful identifiers for the Transport and Logistic sector and their benefit to achieve

⁴⁸ Konovalenko, I., & Ludwig, A. (2019). Event processing in supply chain management – The status quo and research outlook. *Computers in Industry*, 105, 229-249. <https://doi.org/10.1016/j.compind.2018.12.009>.

and consignee, freight forwarders and carriers as well as official bodies like customs and port authorities. The combination of logistics channels and parties implies an opportunity to simplify asset and trade shipment identification using common global data standard Identification Keys and sharing this information between carriers and other service providers.

This opportunity to facilitate asset and trade shipment identification using common global data standard identification may be based on the following GS1 identification standards, as described in the GS1 General Specifications:

- GLN – Global Location Number (parties and locations)
- GRAI – Global Returnable Asset Identifier (transport equipment)
- GIAI – Global Individual Asset Identifier (transport equipment and transport means)
- SSCC – Serial Shipping Container Code (transport units)
- GINC – Global Identification Number for Consignment
- GSIN – Global Shipment Identification Number

These recommendations have been developed in collaboration with the GS1 Member Organisations (MOs)⁵⁰ and the Identification Standards Maintenance Group (ID SMG) working closely with local communities on Transport & Logistics process efficiencies.

AIM is a trade association and global authority and resource in automatic identification and data capture (AIDC) technologies and innovations. An AIM White Paper entitled “Fundamentals of Track and Trace (T&T)”, from 2018 makes reference to ISO 15459. The GS1 standards for GTIN (Global Trade Identification Number), SGTIN (Serialized global trade Item Number), SSCC (Serial Shipping Container Code), GIAI (Global Individual Asset Identifier) and GRAI (Global Returnable Asset Identifier) are all compliant with this ISO standard.

The GS1 system architecture is based on 3 concepts that are linked to each other:

- Standards to IDENTIFY entities in electronic information that can be stored and communicated between trading parties
- Standards to automatically CAPTURE data that is carried directly on physical objects (bridging the physical world with the world of electronic information)
- Standards to SHARE information, both between trading partners and internally, providing the foundation for electronic business transactions and visibility – knowing exactly where things are at any point in time, or where they have been, and why.

NOTE: Although GS1 offers a comprehensive set of standards, including standards for electronic communication, it is very well possible to leverage the identification and capture standards utilized by companies in combination with non-GS1 standards and solutions (as used by e.g., customs/OGA). One such example is the support for the GS1 keys in the WCO data model.

EPCIS, a GS1 “Share” standard for traceability:

- Defines a framework data model, query & capture interfaces
- Helps **share visibility data** across & between enterprises

⁵⁰ GS1 Member Organisations are local GS1 organizations serving their own country (and neighboring country).

- Based on capture of **business process steps as “events”**
- GS1 Keys identify the “what” & “where” & “who” & “when” of visibility events
 - Encoded as Electronic Product Codes (EPCs)
 - Data-carrier neutral (works with **GS1 barcodes** and **EPC/RFID**);
Even works with events captured manually in execution systems.
 - Normatively specified in GS1’s EPC Tag Data Standard (TDS)
- Published as ISO/IEC 19987

A companion standard to the EPCIS, the Comprehensive Business Vocabulary (CBV) 2.0:

- Defines **cross-sector code lists** to populate EPCIS event data
 - Previously defined as URNs and definitions in a PDF standard
 - Each code list will have a Web URI & online definition in CBV 2.0
 - Published as a JSON-LD dataset + browsable tool
- Ensures a common understanding of data semantics
- Underpins the **interoperability** of EPCIS implementations
- Published as ISO/IEC 19988

Dimensions of an EPCIS event

- **What:** What objects are the subject of event (*SGTIN, SSCC, GIAI, etc...*)?
- **When:** When did this event take place (*Date, time, time zone...*)?
- **Where:** Where did this occur...and where are the objects thereafter (*Physical location GLN*)?
- **Why:** Why did this event take place (*Process step, object status, link to transactions, etc...*)?
- **How:** How are these objects (*warm, humid, fast, etc. - **Sensor-monitored condition** -*)
This is a new feature in EPCIS 2.0.

Note: This functionality is not considered in scope for this Track and Trace BRS.

GS1 identifiers provide all trading partners with a standard way to uniquely identify each “physical component” or ‘object’ in the supply chain. These include:

- **Logistics / Transport units**, which can be any combination of goods put together in a carton, in a case, or on a pallet – the Serial Shipping Container Code (**SSCC**).
- **Logical groupings of logistics** units that are assembled to be transported such as a **consignment** – a Global Identification Number for Consignment (**GINC**), or as a **trade shipment** – the Global Shipment Identification Number (**GSIN**).

The difference is the GSIN is used to identify a trade shipment that moves from one location/place (Seller) to the other (Buyer), irrespective of the physical handling in between (in line with the UN/CEFACT trade shipment concept).

The GINC is used by LSP’s to identify groupings of logistics units, appropriate to mode of transport chosen; the GINC corresponds with the UN/CEFACT consignment concept. Hence, one GSIN (for one Trade Shipment) can result in several consignments (each of which may be identified with a separate GINC), while in one consignment (GINC), goods from several trade shipments (GSIN) can be shipped.

- **Individual assets used to transport the goods** – assets like a ship container and truck/trailer – the Global Individual Asset Identifier (GIAI), as well as **returnable assets**, like a returnable pallet used for packaging – the Global Returnable Asset Identifier (**GRAI**)
- **Physical locations or trading partners** like retailers, manufacturers, transport carriers, freight forwarders and LSPs – the Global Location Number (**GLN**).
- **Trade items** like products and services that may be priced, or ordered, or invoiced at any point in any supply chain – the Global Trade Item Number (**GTIN**) for equivalent trade item instances or serialized GTIN (**SGTIN**) for a specific single instance of a trade item.⁵¹

The GS1 identifier for logistics units or SSCC, is captured on a case or pallet using a Logistics Label. Utilizing the GS1 Logistics Label, the SSCC “stays on” the logistic unit through the whole supply chain, giving all trading partners a common reference back to the origin of the logistic unit and who is responsible for the goods. Trading partners can share (real-time) information about the physical events in the supply chain using GS1 eCOM messaging standards (a simplified subset of the UN/EDIFACT standards), Electronic Product Code Information Services (EPICS) and the Global Synchronization Network (GDSN) as a means for secure and continuous synchronization of accurate product master data sharing.⁵²

Figure 16 below depicts a simplified view of a sample supply chain that is quite common. The buyer can be a consumer, a patient or caregiver or a business among others.

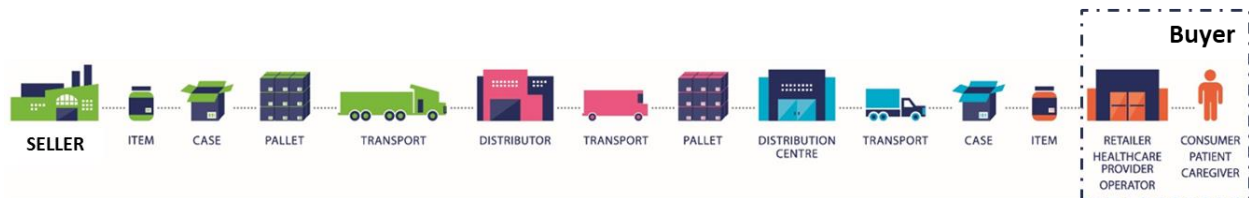

Figure 16. Sample supply chain between Seller and Buyer; GS1

The GSIN may be used for the identification of the trade shipment covering the movement of goods from the Seller to the Buyer. In this Figure 16, it is also clear that there are at least three transport movements. Each of those may be identified with a separate unique GINC. Below we cover options that may be used to exchange information related to the consignments (transport service contracts).

In the Freight Industry, digitalization can assist in improved visibility of freight consignments and interoperability between supply chain partners. Improved visibility can help improve predictability, efficiency and productivity of the freight industry. This can be accomplished by harnessing digital freight consignment and event message data, through electronic data interchange systems, such as GS1’s Transport Instruction (TI), Transport Status (TS) and Electronic Product Code Information Services (EPCIS), which are all part of GS1’s suite of Data Exchange Standards.⁵³

Transport Instruction (TI) messages are used to convey relevant information about cargo that needs to be moved and include information about the consignor/shipper, consignee/receiver, origin and destination locations, cargo type, cargo volume and weight, requested transport service type (transport mode), and planned pick up delivery dates/times, among other elements. The Transport Instruction will be sent by

⁵¹ GS1 Australia. (2020). *Freight Consignment Data Aggregation Pilot Models, Scenarios, Messages & Data Sets*. <https://www.bitre.gov.au/publications/2020/freight-data-exchange-pilot-projects-summary-report-2020>.

⁵² Ibid.

⁵³ GS1 Australia. (2020). *Freight Data Exchange Pilot Project - Summary Report*. <https://www.bitre.gov.au/publications/2020/freight-data-exchange-pilot-projects-summary-report-2020>.

the Logistic Services Buyer (supplier, retailer, 3rd party warehouse or freight forwarder) to a Logistic Services Seller (freight forwarder or carrier) upon order creation. The Transport Instruction can include a request for either executing a consignment or executing a trade shipment. The trading partners need the ability to differentiate between less detailed transport instructions (trade shipments) and more detailed instructions (consignments). Transport Status (TS) messages are used to query and report relevant information about the current status of a freight consignment. A single freight consignment may be linked with multiple TS notification messages, providing a complete record of the process involved in transporting a consignment between consignor (or shipper) and consignee (or receiver). Information contained in TS messages include actual pick-up and delivery locations and times, and information about each transport leg, including mode of transport and vehicle type.⁵⁴

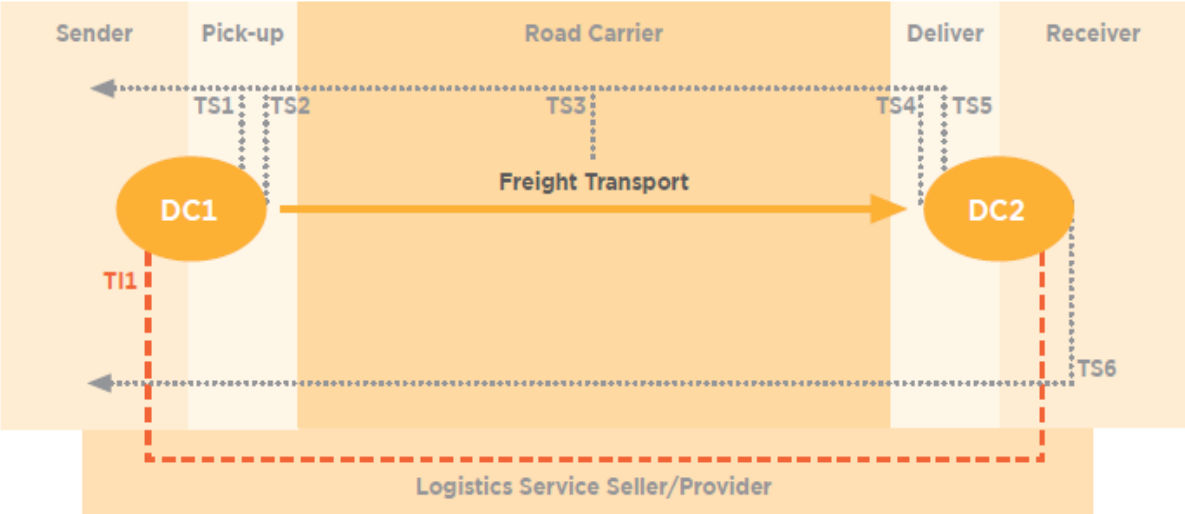

Figure 17. Typical TI and TS message exchanges involved for a single freight consignment; GS1 Australia, 2020 - Freight Data Exchange Pilot Project - Summary Report

Figure 17 illustrates message exchange of one TI message and six TS messages for each consignment in this example.

Key message elements (data items) relevant to production of strategic-level outputs include:

- Consignment (transported trade shipment(s)) identifier – uniquely identifying each consignment - **What**
- Consignor/consignee (sender/receiver) – **Who**
- Origin & destination location – **Where**
- Cargo characteristics (trade item IDs, commodity, volume/weight, quantity) – **What**
- Transport equipment details (equipment IDs, Type, volume/weight, quantity) - **What**
- Transport instructions (mode, vehicle type) – **How**

⁵⁴ GS1 Australia. (2020). *Freight Data Exchange Pilot Project - Summary Report*. <https://www.bitre.gov.au/publications/2020/freight-data-exchange-pilot-projects-summary-report-2020>.

- Planned/actual departure and arrival times – **When**

APPENDIX 4

Coordination between UN/CEFACT and Other Industry Standards Organizations, further detail:

In this appendix we describe how we may combine existing standards and existing identifiers that are already in wide use to achieve seamless tracking and tracing across multi-modal transport. The main challenge is in connecting/linking the available identifiers in a consistent way across the business steps and life cycle of a trade shipment from a Seller of goods to the Buyer of those goods. We start by clarifying the current challenges with this kind of tracking and tracing. We conclude that there is no shortage of identifiers for the objects and entities involved in tracking and tracing.

The first example in Appendix 4 presents an approach whereby consistent data capture and linking of various identifiers can be achieved across large numbers of stakeholders of many different kinds. This approach very much builds on the combination of UN/CEFACT and GS1 standards.

A second example provides a summary of UN/CEFACT work done within the context of “dealing with COVID-19”. It provides some further insights into the direction that digitalization in supply chains will develop and how that may affect tracking and tracing goods from Seller to Buyer.

UN/CEFACT – GS1

The following set of figures will describe various scenarios that relate the sales order contract to the transport movement, and give examples of how the goods are packaged, in what container(s) they are located and what various equipment is used in the transport depending on which mode(s) of transport is involved.

Trade and Transport identity disconnects

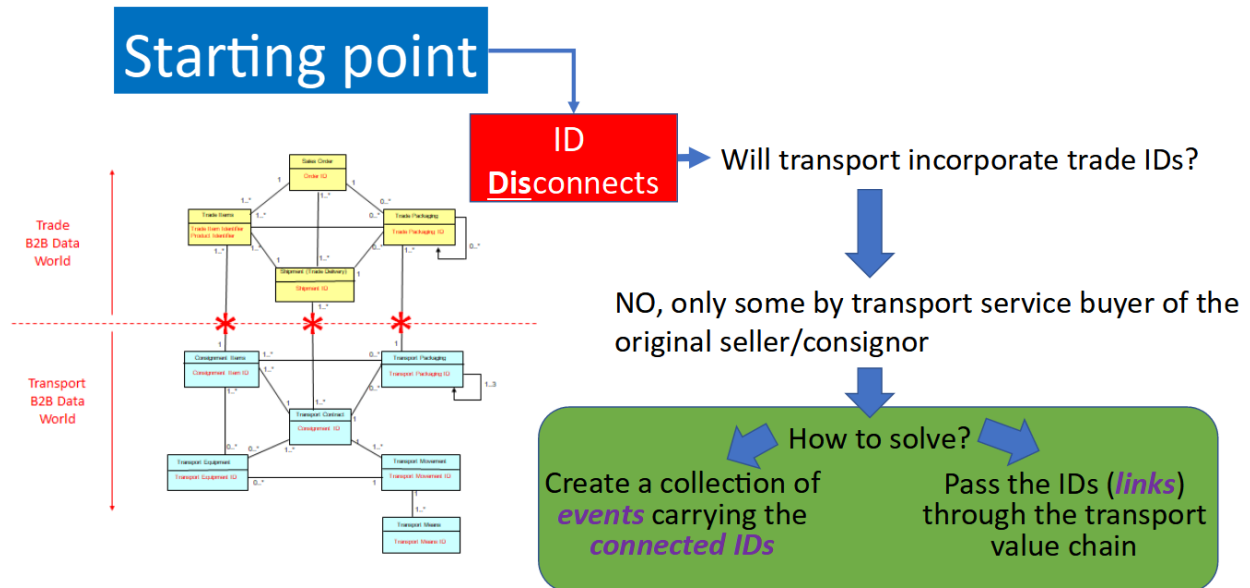

Figure 18. Disconnects in linking IDs between Trade and Transport; UN/CEFACT and GS1

Figure 18 above illustrates that there already is a wealth of good identifiers linked to trade transactions (that is the Buy/Sell transaction between Buyer and Seller of the Goods) e.g., identifications for Sales Order contract/Trade Shipment, Product/Trade item codes that may be based on global data standards like ISO and GS1.

The figure also clearly shows that there is a similar wealth of identifiers linked to the execution of transportation. These identifiers focus on transport service contracts, transport units/packages, transport documents, transport equipment and transport means. There are some for which global data standards exist and are also widely used (e.g., identification for the intermodal container and IMO vessel number). There are also quite a few where global data standards for identifiers are available but are not yet widely adopted in the industry.

The main challenge in the supply chain between Seller and Buyer is indicated in the center of the figure. Currently, the stakeholders in the trade transaction and the stakeholders involved in the transportation execution do **not** connect their identifiers and often do not even exchange the relevant identifiers between them.

In the illustrations below we aim to explain how these trade identifiers and transport identifiers may be linked as part of **existing/current** processes already widely adopted throughout the industry.

ID DISCONNECTS: occur especially in multi modal transport cases.

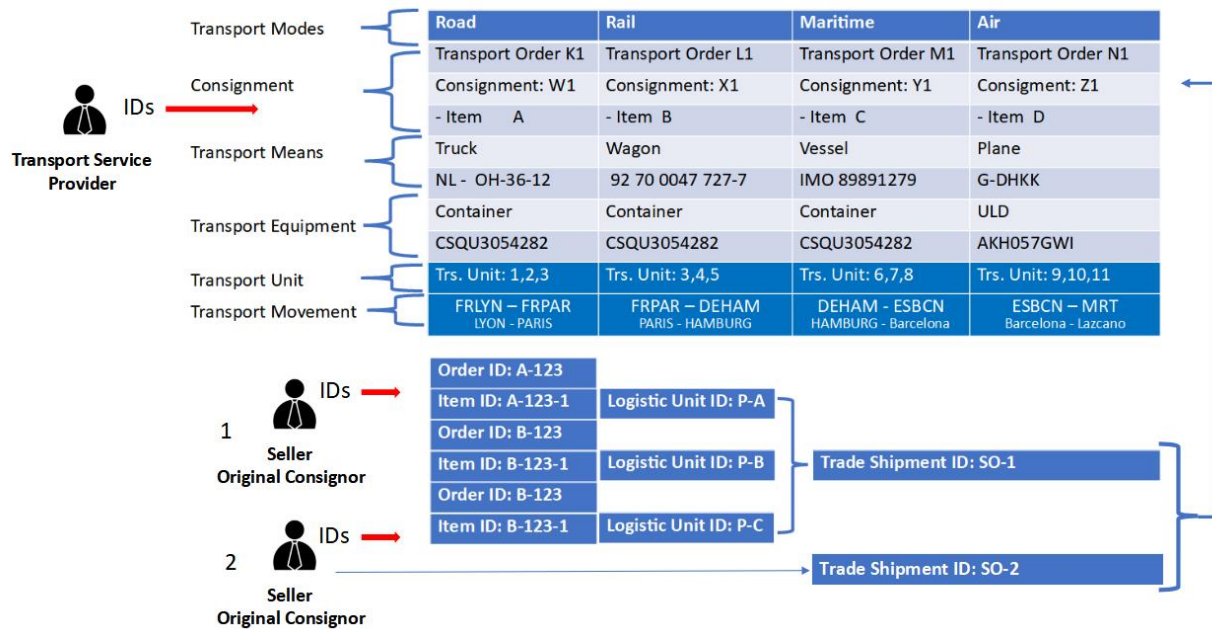

Figure 19. ID Disconnects in multi-modal transport cases.

The above Figure 19 illustrates (using some example values) some of the main identifiers used in the trade context (bottom part of the figure) and main identifiers used in the transportation context (top part of the figure). This figure also illustrates that trade shipments become transport consignments (arrow on the right).

Also illustrated in this figure, two trade shipments have been consolidated into one consignment. The same (combination of) trade shipments may be transported on multiple different consignments using different modes of transport.

The figure does not specify exactly how the trade identifiers (including the trade shipment/Sales Order ID) are linked to each other and it also does not indicate the links among the trade shipments and the consignments nor the links between the different consignments (if any). That further illustrates the current confusion in the industry on how to connect the identifiers of the Trade context with those used in the Transportation context.

In Figure 20 below we dive a bit deeper into how the links may be established. The GS1 keys alone, however, do not solve the ID Disconnect Problem between Trade and Transport environments.

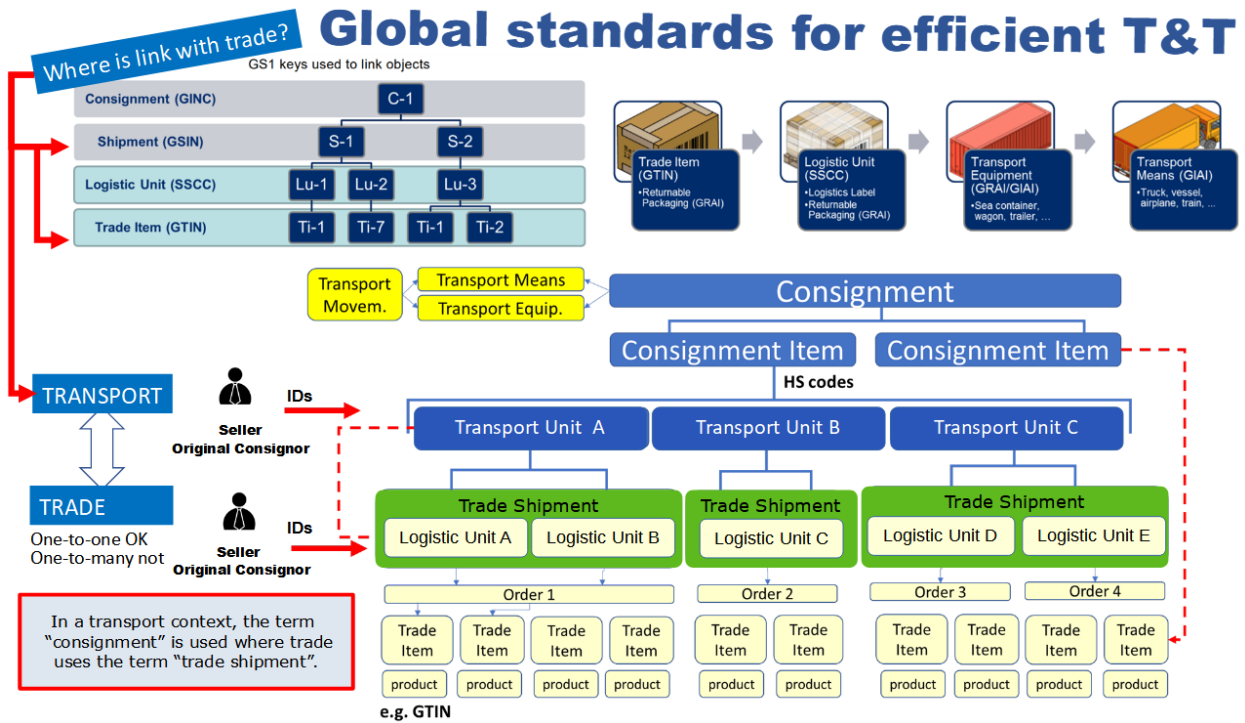

Figure 20. Combining global standards to solve the ID disconnect problem; UNECE/GS1

Across the top of Figure 20, we see a summarized overview of how trade items may be linked to logistic units, how logistic units may be linked with trade shipments and how trade shipments may be linked with a consignment. The top-right part illustrates how trade items are physically consolidated into logistic/transport units, then transport units may be consolidated into transport equipment and the transport equipment may then be consolidated on a transport means (e.g., truck or ship) for transportation. These consolidation steps may take place at several different locations along the journey of the goods from Seller to Buyer. Below we will go deeper into the business steps and trade shipment life cycle (including consolidation and deconsolidation).

The bottom part of the figure shows how the logical links among the trade identifiers (trade item, Sales Order, trade packages/logistic units, trade shipments) and the transport identifiers (transport units, consignment items and consignment) may be established.

To support a consistent view of all links between the identifiers and to ensure industry can build on well-established global data standard identifiers, we will need a range of identifiers from various global data standard providers such as ISO, IMO, IATA, GS1, WCO, WTO, IRU, BIC, FIATA, DCSA, and IPCSA, among others. No single global data standards development body can support the full scope of intermodal transportation. However, it is important to note that:

Good global data standard identifiers exist for all objects and entities that need to be identified for harmonized cross industry track and trace across intermodal supply chains.

ID Disconnect points

Events are the basis of Track and Trace

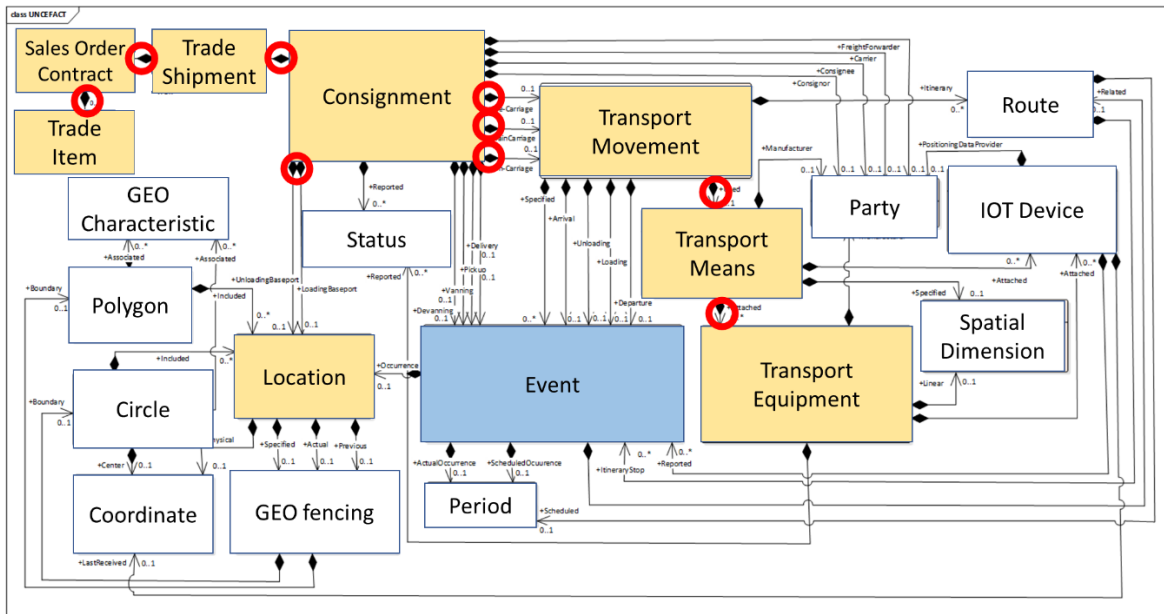

Figure 21. IFTSTA based model – ID Disconnects remain when multi-modal transport is involved, UN/CEFACT IFTSTA

To support Track and Trace, stakeholders need to capture and share relevant events along the journey of the goods (trade shipments) from Seller to Buyer. Figure 21 above and Figure 22 below make that event the central object to which all other entities and object are linked.

Both figures are based on long-establish global data standards for the exchange of Event (track & trace) information: the UN/EDIFACT IFTSTA International Multi-Modal Status Report Message⁵⁵ (figure above) and EPCIS (figure below).

The figure above also indicates that some of the entities and objects (especially the trade-related information) may not be directly linked to the event that is exchanged.

Both the IFTSTA and EPCIS global data standards have been designed to exchange information that has in fact happened (they may do so in near real-time). They are **not** intended to exchange information about future events (events that are being planned to occur but may in fact not occur or at least not exactly as originally anticipated).

Both IFTSTA and EPCIS also recognize the essential role that the exact identification of the location plays when event information will be exchanged.

In short, any event must indicate to what object (e.g., transport unit) the event pertains, where the event occurred, when it occurred and in what business context the event occurred.

⁵⁵ [UN/EDIFACT D.21A - Message \[IFTSTA\] \(unece.org\)](https://unece.org/edifact/d21a).

The EPCIS event model was developed more recently building on the UN/EDIFACT IFTSTA standards. The EPCIS standard recognizes four different types of events, whereas the IFTSTA standard focusses on the “Object Event” indicated in Figure 22 below (middle layer left side).

Sharing events in a respository. Linking IDs of assets and others.

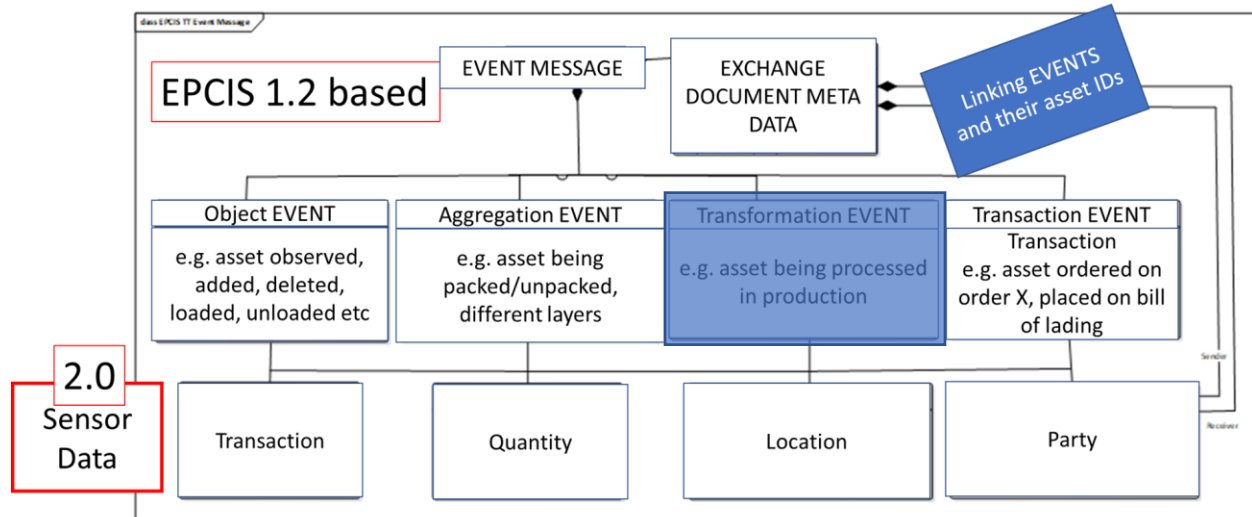

Figure 22. EPCIS standard overview; GS1

Three of the four event types⁵⁶ shown in Figure 22 above, will be essential to cover all events relevant to capture and link all trade and transport identifiers throughout the entire journey of goods between Seller and Buyer.

- Object Event
- Aggregation Event
- Transaction Event

Below we will describe the main processes that the goods go through from the moment they have been ordered all the way through to when they have been confirmed as delivered to Buyer.

EPCIS version 2.0 includes a fifth event type named “association event” which describes the association or disassociation of one or several physical objects with a parent object or a specific physical location. It also includes certification info.

⁵⁶ The EPCIS Event type that is NOT relevant for this document has been “grayed out” using a transparent blue box.

Linking Trade information to Transport information

The Sellers (warehouse) view - Packing

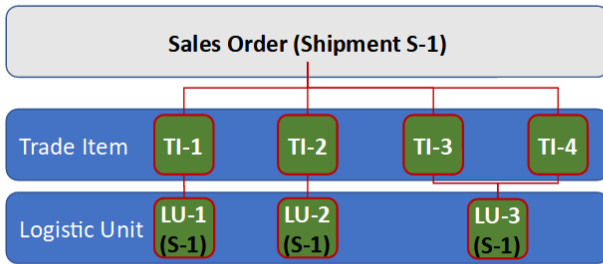

- Sales Order is released to warehouse for packing
- For different Trade Items ordered (different quantities each) pickers collect the Trade Items
- Pickers record how many of each Trade Item they put into each box (Logistic Unit). E.g.,
 - 5 of TI-1 into box LU-1.
 - 3 of TI-2 onto pallet LU-2.
 - 2 of TI-3 plus 1 of TI-4 into parcel LU-3
- This creates the links between IDs of the Sales Order, the Trade Items and the Logistic Units (packages created in the warehouse).
- Logistic units containing the Trade Items are now moved to the Despatch area of the warehouse

NOTE: The green boxes show the Identification Numbers (IDs) in white text; Shipment or Shipments that the Logistic Unit contains Trade Items for are indicated in black text in the green boxes.

Figure 23. Linking trade items to logistic units⁵⁷ - Packing; GS1

The starting point of the journey of the goods is when they will be picked and packed and made ready for transportation at the origin (the Seller’s warehouse). That process is outlined in Figure 23 above. These goods will be picked and packed based on a sales order contract. A Transaction Event may be used to record what Trade Items have been ordered under which Sales Order ID. This creates the links between the Trade Items and the Sales Order (resulting in Trade Shipment). Looking at the Shipment Data Pipeline (see figure 9), this step registers the relevant details of the sales order contract on the data pipeline.

The Trade Items will be picked from warehouse locations and placed into a logistic unit⁵⁸ (LU) as shown in the figure. A logistic unit may contain a single trade item (product code) only and that would be called a homogenous logistic unit. You see that with the two LU on the left. A logistic unit may also contain several different trade items (product codes) in which case it is referred to as “mixed”.

Whenever a trade item is placed in the logistic unit, the operator records (usually by scanning) which trade item they placed into which logistic unit and also the quantity of the trade item (e.g., 5 units of TI-1 placed into the box identified with LU-1). These EPCIS Aggregation events establish the link between the logistic units, the trade items, and the sales order (trade shipment).

The set of events mentioned above are the first to be added to the Shipment Data Pipeline.

These links are the foundation for being able to respond to the question from beneficial cargo owners (be they sellers or buyers): “Where are my goods?”.

⁵⁷ As indicated in Appendix 1 definitions, the term “logistic unit” can be used for units moving around in the warehouse when preparing goods ordered on Sales Orders for transportation. We have to use the term logistic unit here because the term “transport unit” is reserved for transport movements.

⁵⁸ In figure 19 and 20, the logistic units in this process step are referred to as Trade Packages.

Linking Trade information to Transport information

The Sellers (warehouse) view – Despatch Shipment

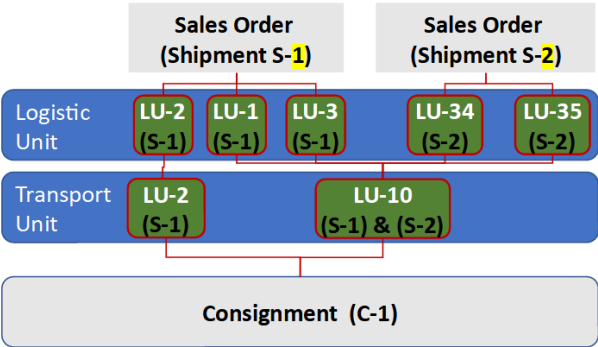

- A Sales Order (Shipment) may be consolidated with other Sales Order into a single consignment for Despatch/Collection from the warehouse
- In the process new Logistic Units may be created for transport execution purposes (they are often called transport units). E.g.,
- LU-1, LU-3, LU-34 and LU-5 are combined into LU-10 for transport away from the warehouse.
- LU-10 contains Goods from S-1 and S-2 shipments
- LU-2 (with goods from S-1) will be despatched as-is.
- Sender (Warehouse) books Consignment (C-1) with first Carrier consisting of LU-2 and LU-10
- First Carrier collects the Consignment (C-1)

- During this process of creating transport units the links between the logistic units created earlier and the transport units are captured.
- When the Consignment is created, the links between the Consignment ID (C-1) and the transport units are captured.

Figure 24. Linking logistic units to transport units; GS1

The next step in the journey is the despatch of consignments containing the trade shipments from the origin (seller’s warehouse). Looking at the Shipment Data Pipeline, this step posts the relevant information for “Goods booked for transport” and “Transport service contract (shipping instruction)” to the data pipeline.

Figure 24 above illustrates that multiple trade shipments may be combined (consolidated) into a single consignment (transport service contract). Trade shipments may also become a consignment on their own. In some cases, the trade shipment may be split into more than one consignment (e.g., it is too large to be carried on a single transport means; it may be a mix of hazardous and non-hazardous cargo and you split to avoid paying hazmat rates for the entire trade shipment).

The consolidation scenario is common to e-commerce fulfilment. Small trade items and logistic units may be combined into larger transport units (e.g., roll-cages, crates, bags etc.) for easy handling on the way from the warehouse to the first hub/node in the network enabling the end-to-end journey of the trade shipment from seller to buyer.

Looking at the EPCIS event types, we will see a combination of Transaction events (adding transport units to the Consignment Note), Aggregation events (consolidating logistic units into a transport unit) and Object events (keeping track of the various logistic units within the warehouse).

Consolidating Consignments E.g. Freight Forwarder combining flows for (main carriage) transportation

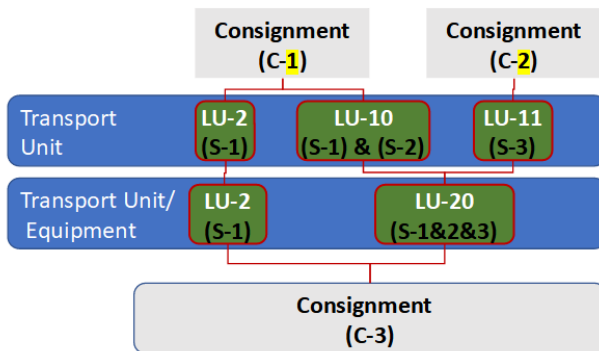

- Consignments may be consolidated during the journey from seller to buyer
- E.g., consignments (C-1 and C-2) received from multiple Sellers may be combined in a larger consignment (C-3)
- The LSP (Freight Forwarder in this example) may create new Transport Units in the process.
- LSP will link the new Transport Units to the Transport unit IDs for the Consignments that have been consolidated
- e.g., LU-11 and LU-10 combined into LU-20 containing trade items from S1, S2 and S3
- LSP will also create the links between the consolidated consignments (C-1 and C-2) and the new combined consignment C-3)

- During this process of creating transport units the links between the transport units (LU-10 from C-1 and L-11 from C-2) and the transport units just created (LU-20) are captured.
- When the new Consignment is created, the links between the consolidated Consignment IDs (C-1 and C-2) and the new Consignment ID (C-3) are captured.

Figure 25. Consolidating consignments; GS1

Logistic Service Providers will often combine consignments they receive into larger consignments to optimise the transport execution of the next leg in the journey of the goods as anticipated in the original consignment transport service contract. Consolidation may occur at any hub/node in the transport and logistics network.

Figure 25 shows the “complex” case of this type of scenario. In many (maybe even most) cross-docks, the transport units received as part of the inbound consignments (C-1 and C-2) are NOT combined into new transport units. In effect they traverse the cross-dock facility as-is (just like LU-2 in this slide).

The complex scenario is quite common where the LSP receives consignments that are less volume than will fit into the transport equipment they prefer to use for the next leg of transportation. For example, the LSP may receive pallets from two (or more) different consignments and the LSP can fill/stuff an intermodal container nicely by combining these pallets in the container.

The simple scenario applies to most cross-docks in road transport who will receive pallets and they will also send those pallets out as-is.

In both cases, the transport units for the outbound leg will have to be linked to the new consignment note using an EPCIS Transaction event.

Loading consignments onto Transport Means combining flows for transportation

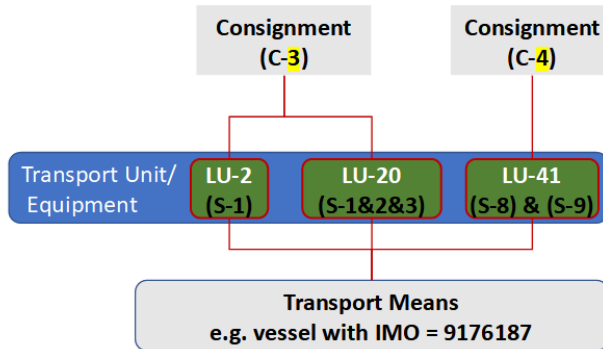

- Transport means (e.g., vessels) will often carry multiple consignments on a single trip
- Consignments may be from different shippers and may contain Trade items related to multiple Sales Orders from multiple different Sellers.
- E.g., consignments (C-3 and C-4) may be combined on a single transport means (IMO-9176187)
- Transport Units are loaded as-is (no repacking).
- LSP will link the Transport Units to the Transport Means IDs
- **Knowing where the Transport Means is, implies knowing where Transport Units and hence where the Goods (Trade Items/Sales Orders) are.**

- During this process of loading the links between the transport units (LU-2, LU-10 from C-3 and L-41 from C-4) and the transport means (IMO-9176187) are captured.
- These units hold Trade Items for multiple Sellers/Sales Orders (S-1, S-2, S-3, S-8 and S-9)

Figure 26. Loading consignments on transport means; GS1

Loading will occur at any network hub/node anywhere in the journey of the trade items from Seller to Buyer. Figure 26 is merely an example involving one specific mode of transport and transport means. This same process may also occur at a warehouse when trucks are loaded with transport units, at a cross-dock where pallets are loaded on the next leg of the journey, or at port terminals where intermodal containers may be loaded on ocean-going vessels, barges, or rail-wagons for onward transportation.

Marketplace warehouse will often hold goods from multiple Sellers on their platform. The individual Sales Orders for these Sellers would become multiple different consignments (e.g., based on delivery speed and/or final destinations). They may still be despatched from the marketplace's warehouse on a single truck to be dropped off at the most appropriate next LSP facility.

Looking at the EPCIS standard, we would capture the loading of transport units/equipment using Object events. In the previous step, the link between the transport units and the consignment note had already been established; here we add the link to the transport means on which the goods are actually transported.

The Shipment Data Pipeline indicates several actions that imply or explicitly refer to loading e.g., "Goods loaded for transport", "Goods departed port of loading", "Transfer" (related to transshipment), "Goods departed the port of discharge".

UNloading consignments from Transport Means

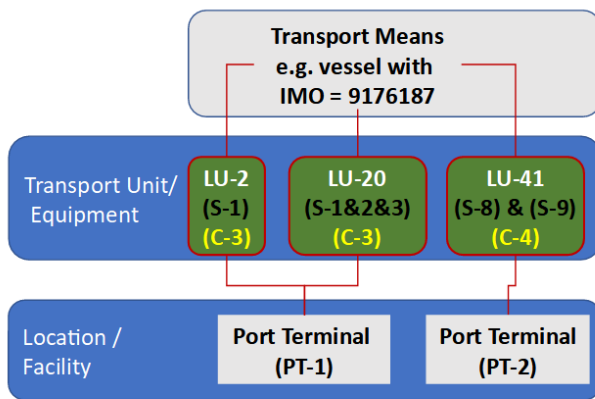

- Transport means may unload different transport units (related to consignments) at different locations
- E.g., consignments (C-3 and C-4) may be unloaded at different facilities
 - C-3 at port terminal PT-1 and
 - C-4 at port terminal PT-2
- Consignments may be from different shippers and may contain Trade items related to multiple Sales Orders from multiple different Sellers. These units hold Trade Items for multiple Sellers/Sales Orders (S-1, S-2, S-3, S-8 and S-9)
- **Knowing where the Transport Units are, implies knowing where the Shipments and Goods (Trade Items/Sales Orders) are.**

- During this process of unloading the links between the transport units (LU-2, LU-10 from C-3 and L-41 from C-4) and the transport means (IMO-9176187) are deactivated.
- The process also captures the new links between the facility/location where the transport units are after unloading.

Figure 27. Unloading transport units from transport means; GS1

Unloading may occur at any network hub/node anywhere in the journey of the trade items from Seller to Buyer. Figure 27 is merely an example involving one specific mode of transport and transport means. This same process may also occur at a warehouse (e.g., at the buyer’s facility) when trucks unload transport units, at a cross-dock where pallets are unloaded (before moving onto the next leg of the journey, or at port terminals where intermodal containers may be unloaded from an ocean-going vessel, barge or rail-wagon.

Looking at the EPCIS standard, we would capture the loading of transport units/equipment using Object events. In the previous steps, the link between the transport units, the consignment note, and the transport means had already been established. Here we “unlink” the transport units from the transport means. The links between the transport units and the consignment note will continue to exist.

The Data Pipeline indicates several actions that imply unloading e.g., “Arrived at port of loading”, “Transfer” (related to transshipment), “Goods arrived at final port of discharge”, and “Goods delivered”.

NOTE: The “Goods delivered”⁵⁹ event (and associated EPCIS Object events) concludes the end-to-end track & trace across multiple modes of transport.

⁵⁹ Goods Delivered Event is reserved for when the Goods Sold have been delivered to the facilities of choice of the Goods Buyer. So not to be confused with any unloading/delivery before that point in the journey.

De-Consolidating Consignments E.g. Freight Forwarder splitting flows after (main carriage) transportation

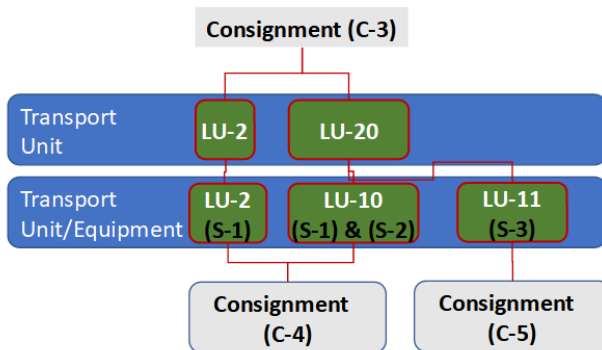

- Large consignment (C-3) may be de-consolidated and new consignments created for onward transportation.
- LSP will record new consignment IDs and link them to the transport units for onward transportation. E.g., consignments C-5 and C-4 are linked with C-3.
- LSP links LU-10 and LU-2 with Consignment C-4;
- And transport unit LU-11 with Consignment C-5
- **Consignment C-5 may be the delivery of Shipment S-3 to the Buyer**
- **Consignment C-4 may be further split in a next hub in the network into separate delivery consignments for Shipments S-1 and S-2**

- When the new Consignments are created, the links between the Consignment IDs (C-4 and C-5) and the transport units (LU-2, LU-10 for C-4 and LU-11 for C-5) are captured.
- The previous links between the transport units and the “inbound” consignment are deactivated. E.g., LU-2 is no longer actively linked with C-3; same for LU-20 and C-3. The links still exist in history journal/ledger for the transport unit.

Figure 28. De-consolidating consignments; GS1

When a consignment is a consolidation of multiple consignments, then at some hub/node in the network the consolidated consignments must be split (de-consolidated) into the constituent consignments.

Figure 28 shows the complex scenario where a transport unit must be opened and split into more than one smaller transport unit. This is a common scenario in intermodal container-based transportation. The intermodal container may contain pallets from several different smaller consignments. Those smaller consignments need to be transported in different directions from the network hub/node onward. So, the pallets must be removed from the container and then added to the new consignments used to manage the onward transportation to the next destinations for the deconsolidated transport units (based on the trade shipments they belong to).

In some cases, the next destination will be the Buyer’s facility (C-5 in the figure above). In other cases, the next destination is another node/hub in the network (C-4 in the figure above). When the consignment (C-4) arrives at the next hub, it may in turn be deconsolidated (following the description in this process step).

Using the EPCIS standard, we will use Transaction events to unlink the consolidated transport units from the inbound consignment note (C-3) and to link the deconsolidated transport units to the new outbound consignment notes. We will also use the Aggregation event for unlinking the deconsolidated transport units (LU-10 and LU-11) from the consolidated transport unit (LU-20).

Linking Trade information to Transport information

The Sellers (warehouse) view – Despatch Shipment (Split)

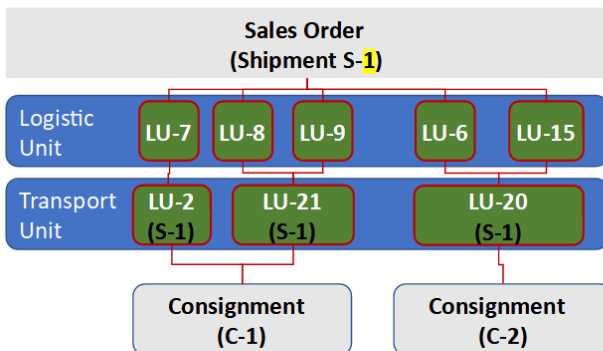

- A Sales Order (Shipment) may be split for transportation away from the warehouse
- In the process new Logistic Units may be created for transport execution purposes (they are often called transport units). E.g.,
- LU-1 and LU-3 are combined on a pallet (LU-11) for transport away from the warehouse.
- LU-2 will be shipped as-is (becomes a transport unit).
- LU-4 and LU-5 are combined into LU-10
- Sender (Warehouse) books Consignment (C-1) with a first Carrier consisting of LU-2 and LU-11
- Sender (Warehouse) books Consignment (C-2) with a first Carrier consisting of LU-2 and LU-11
- Carrier collects Consignment C-1
- Carrier collects Consignment C-2

- During this process of creating transport units the links between the logistic units created earlier and the transport units are captured.
- When the Consignment is created, the links between the Consignment IDs (C-1 and C-2) and the transport units are captured.

Figure 29. Splitting a Trade Shipment in Multiple Consignments; GS1

Using the EPCIS standard, we will cover the Transaction event to link the transport units to the separate consignments. The links between the logistics units, transport units and trade shipment have been established in prior process steps. So now we have linked the trade shipment (through the logistic and transport units) to the consignments.

Splitting of trade shipments (contained in consignments) may occur for any leg in the end-to-end journey for a wide range of different reasons. However, the process step described in Figure 29 (in combination with steps described above e.g., consolidating/splitting consignments) may cover all those scenarios.

The Shipment Data Pipeline does not mention splitting trade shipments into multiple consignments (for the same “leg” in the journey). However, it is a common practice to split consignments in air transport during a single leg or a portion of a journey, for the splits to travel on the same transport means at the same time, or different means at a different time or date. It is also possible to have splits of splits. Splits may also need to be re-consolidated at a transit point prior to final transport destination for Customs purposes.

Once the split has been executed the transportation for those consignments and associated transport units and transport equipment is executed in the same way as described above in the previous Figures 21-27.

UN/CEFACT – COVID-19 Project

In this second example of the coordination between UN/CEFACT and other standards organizations, we explain some of the next steps in the move toward digitalization, and how they relate to the track and trace processes that are the focus of this BRS, with the goal of future operational and systems interoperability.

The COVID-19 pandemic accelerated the adoption of digital technologies by businesses around the world, although significant barriers continue to prevent the full digitalization of trade-related processes.⁶⁰ A recent effort of UN/CEFACT, requested by UN Headquarters in New York, was investigated and developed for facilitating the more rapid movement of healthcare goods, with enhanced visibility at any time, regardless of the mode of transport. This COVID-19 effort illustrates the correlation of data elements described in the UN/CEFACT Core Component Library, Multi-Modal Transport dataset between the various modes of transport. This project required business understanding and coordination with a number of standards organizations and experts involved in all modes of transport, in order to verify that the UN/CEFACT data and correct relationships were fully captured in the MMT-RDM to facilitate intermodal communications regardless of which mode was being utilized.

Figure 30 below illustrates the wide array of standards and standards bodies involved in this effort, and outlines some of the tasks involved to fulfill this mandate.

⁶⁰ <https://www.mckinsey.com/business-functions/mckinsey-digital/our-insights/the-new-digital-edge-rethinking-strategy-for-the-postpandemic-era>.

Multimodal corridor approach :

Ready standards or standards under preparation	Documents on which to	a pilot project
<p>1. Standards (executive guide; business requirement specification; business name structure; subset; CCL structure; XLS guidelines; XLS index, using as a model the eMR standard) www.unece.org/unecefact/mainstandards.htm already prepared for the following documents:</p> <ul style="list-style-type: none"> eCMR Cross Industry Invoice Cross Industry Delivery Cross Industry Catalogue Cross Industry Quotation Cross Industry Remittance Advice Cross Industry Scheduling Cross Industry Ordering Process Material Safety Data Sheet Details (MSDS) Contract Financial Execution Management Market Research Information Verified Gross Mass (VERMAS) documents International Forwarding and Transfer documents Smart container information A number of agricultural certificates, accounting and other <p>These standards you can find at www.unece.org/unecefact/m</p>	<ul style="list-style-type: none"> eCMR 	<ul style="list-style-type: none"> UML diagram; HTML
<p>2. Standards to be finalized in Sept. 2020</p> <ul style="list-style-type: none"> Provisional booking Firm booking Booking confirmation Shipping instructions Waybill Status report Status request Packing list RA (Railway Agreement) 	<ul style="list-style-type: none"> Bill of Lading (BoL) / maritime waybill Packing list 	
<p>3. Standards to be finalized in 2021</p> <ul style="list-style-type: none"> Inland water transport documents Maritime documents CIM/SMGS Consignment Note; SMGS Consignment Note; CIM/SMGS Wagon List (freight manifest) (Appendix 7.2 to point 20) https://www.cit-rail.org/en/freighttraffic/manuals) Invoice for Customs eCERT (sanitary/phytosanitary certificates and basis for other certificates): Revise implementation guidelines (+ schema, subset) for the different certificates, aligned to the Ship-Pay Reference Data Model 	<ul style="list-style-type: none"> BoL / maritime waybill Invoice for Customs SMGS, CIM/SMGS or CIM Consignment Note CIM / SMGS Wagon List (Appendix 7.2 to point 20) Container List (Appendix 7.4 to point 20) Handover sheet (Appendix 3 to SI to SMGS) https://osid.org/api/media/resources/1603431 Inland water transport documents CO, C/O (preferential or nonpreferential) 	

Align data in these documents with UN/CEFACT standards and reference data models

Figure 30. Alignment of other organization standards with those by UN/CEFACT, ICAO-UNECE Meeting of Experts on Supply Chain Digitalization Collaboration, 20 January 2021

The various multi-modal transport data elements were compiled into an Excel spreadsheet to provide correlation, where possible for intermodal transport across the various modes.

The conclusion from this study is that all primary track and trace data elements, their context, standards body references and relationship between these primary elements are already in the UN/CEFACT Core Component Library, in the Supply Chain Relational Data Model (SCRDM) and Multi-Modal Transport Relational Data Model (MMT-RDM) subsets.

There is no need to add any elements for track and trace functionality to meet the business requirements identified in this BRS.

APPENDIX 5

Tracking and tracing business and technical considerations, further detail:

Track and Trace overview

The scope of the project covers two distinct concepts:

- a) **tracking** - which is monitoring and recording the current location and status of the traded goods, once consigned to a transport operator(s), and
- b) **tracing** - which is monitoring and documenting the history of transport of traded goods from original consignor to final consignee, i.e., the combined history of the tracked events, regardless of the type of goods or the mode(s) of transport deployed for their transportation.

In the framework depicted in Figure 31 below are different dimensions that have been considered in the *UN/CEFACT Cross-Industry Track and Trace Project*.

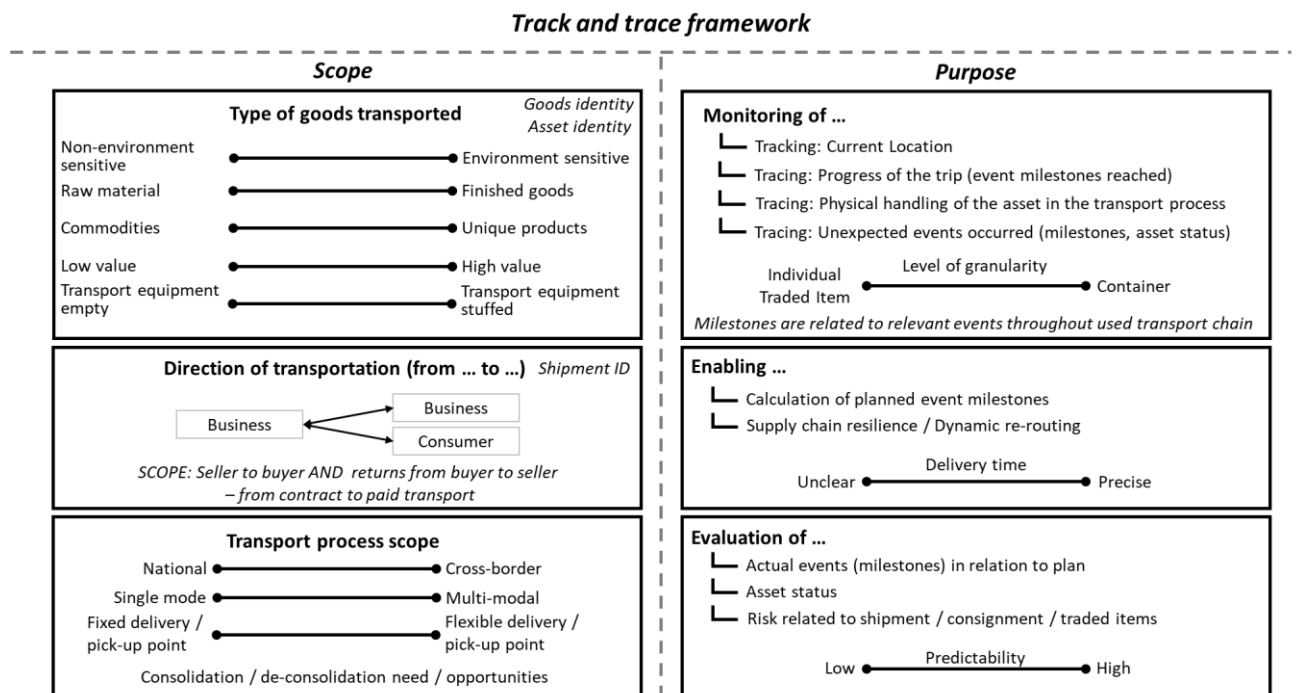

Figure 31. Scope and purpose of track and trace applications, UNECE/UN/CEFACT INTEGRATED TRACK AND TRACE FOR MULTI-MODAL TRANSPORTATION, WHITE PAPER, 20 April 2021

Additional Tracking considerations include:

- Tracking requires transport movement
- **Tracking takes place when there is at least one transport service contract between two parties to transport consignment(s) as part of the movement of goods from seller to buyer.**
- Complexity of the various tracking scenarios depends on:
 - How and where raw materials or goods are obtained for sale
 - Quantity of goods produced
 - If additional processing or manufacturing is required before transport

- Distance and country boundaries between seller and buyer,
- Participants in the process, who increase in number and roles as the scenario becomes more complex
- Intermodal transport generally begins when geographical concerns require a different mode of transport and a new transport service contract for onward movement of goods of the same sales order contract (Trade Transaction).

Benefits from Track and Trace solutions

The ultimate goal in supply chain movement and communication is to ensure that the flow of goods is as smooth, predictable, reliable, resilient and sustainable as possible based on the exchange of information that guarantees, “*What is understood is what is sent*”⁶¹. And it needs to be done at affordable costs compared to the value of the goods being tracked and traced.

Motivated by factors such as operational efficiency standards, competitive pressures, heightened customer expectations, and governmental regulations, both public and private organizations are searching for mechanisms to reduce risks by gaining data-driven visibility into the physical location, condition, and context of their products and assets (Delen, Hardgrave, & Sharda, 2009)⁶².

Increased transparency during the multi-modal transportation of traded goods from seller to buyer offers new opportunities and huge benefits for supply chain optimisation that did not exist prior to the widespread adoption of digital technologies.

Lowering costs

It is important to note that standardization is vital to lowering the cost of cross-border international trade.⁶³

Global data standards enable identification for all products, business and logistic locations, documents, and sharing information across enterprises, so that users can gain a shared view of goods as they move through the supply chain, enhancing supply chain visibility, serving as the foundation for seamless cross-border information flow, facilitating smooth cross-border trade.⁶⁴ Cross-boundary information sharing with Information Technology (IT), is defined as the collaboration or interconnection of different information systems or telecommunication technologies, to share data between entities by using a common conceptual schema.⁶⁵ Voluntary information sharing by supply chain partners differs from traditional mandatory declaration for Customs purposes, therefore, information sharing should have the nature of a public-private data partnership.

Information sharing can be achieved through digital trade infrastructures⁶⁶, such as data pipelines, which can be viewed as web-based seamless digital infrastructures, linking the systems of multiple

⁶¹ [Direct quote from the European Interoperability Framework \(EIF\).](#)

⁶² Delen, D., Hardgrave, B.C., Sharda, R., Chain management through enhanced information visibility. *Prod. Oper. Manage.* 16 (5), 612–624.

⁶³ ABAC. (2011). APEC Supply Chains: Identifying Opportunities for Improvement: USC Marshall School of Business ABAC Team 2011 https://www2.abaonline.org/assets/2011/4%20Honolulu%20Hawaii%20USA/2011-APEC%20Supply%20Chains_Full%20Report.pdf.

⁶⁴ GS1. (2017). *GS1 and global data standards*. Hong Kong Barcode | Product Barcode Standard | Global Standard Barcode. <https://www.gs1hk.org/sites/default/files/publications/18%29%20GDS.pdf>.

⁶⁵ Barki, H., & Pinsonneault, A. (2005). A model of organizational integration, implementation effort, and performance. *Organization Science*, 16, 165–179.

⁶⁶ Rukanova, B., Henningsson, S., Zinner Henriksen, H., & Tan, Y. H. (2018). Digital trade infrastructures: A framework for analysis. *Complex Systems Informatics and Modeling Quarterly*, 14, 1–21.

parties in the international supply chain (Hesketh, 2009; 2010).^{67 68} Data collaboration for the common good has now been recognized as a good opportunity to enable trust and innovation through public-private partnerships.⁶⁹

Situational awareness – Customer expectations

Supply Chain decision-making is increasingly reliant upon access to real-time data, and the most beneficial real-time data is now likely generated and delivered by some form of tracking technology.⁷⁰ Additionally, supply chain (real-time) visibility over time has become a crucial factor for companies in terms of customer satisfaction.⁷¹ Many supply chain related issues arise due to the lack of sharing information between the members in the supply chain.⁷²

Keeping track of the tsunami of transportation of goods and the related data pertinent for identification and location are imperative for all supply chain stakeholders. The ability to track products and assets (in real-time) throughout the value chain has become increasingly important in a wide range of industries⁷³ and it would fundamentally transform supply chain management.

Machine Learning and Artificial Intelligence

The availability of much more and far more reliable track and trace data also enable the deployment of advanced technologies within the context of supply chain operations in general and transport and logistics in particular.

Based on more reliable and less ambiguous data technologies like artificial intelligence may be used to make more decision (more) automatically. The AI may make some decisions without interactions with a human operator. Alternatively, the AI may interact with the human operator where that makes sense e.g., the AI “feels” the situation requires a human to evaluate or the system has been configured to always ensure a human being reviews the proposals from the AI.

Machine learning technologies may be used with better results based on more reliable and less ambiguous data than is feasible based on the current data sets gathered in most transport and logistics environments.

Regulatory pressures

Cross-border risk management processes (e.g., in the EU and USA) are requiring ever more data also related to the tracking and tracing for the trade shipment that is crossing the border (for import or export). This means that stakeholders involved in the movement of the trade shipment will need to be able to share the required track and trace events.

⁶⁷ Hesketh, D. (2009). Seamless electronic data and logistics pipelines shift focus from import declarations to start of commercial transaction. *World Customs Journal*, 3(1), 27–32.

⁶⁸ Hesketh, D. (2010). Weaknesses in the supply chain: Who packed the box? *World Customs Journal*, 4(2), 3–20.

⁶⁹ WEF. (2019). Data collaboration for the common good: enabling trust and innovation through public-private partnerships. http://www3.weforum.org/docs/WEF_Data_Collaboration_for_the_Common_Good.pdf.

⁷⁰ Basole, R.C., Nowak, M. (2016). Assimilation of tracking technology in the supply chain. *Transport. Res. Part E*, <http://dx.doi.org/10.1016/j.tre.2016.08.003>.

⁷¹ Bolte, N.-O., & Goll, D. C. (2020). Potential analysis of track-and-trace systems in the outbound logistics of a Swedish retailer (Dissertation). Retrieved from <http://urn.kb.se/resolve?urn=urn:nbn:se:hj:diva-48986>.

⁷² J. Li, M. J. Shaw, R. T. Sikora, G. W. Tan, and R. Yang, (2001). "The effects of information sharing strategies on supply chain performance," Working Paper, URL: <http://citeseerx.ist.psu.edu/viewdoc/summary?doi=10.1.1.144.4916>.

⁷³ Butner, K., (2010). The smarter supply chain of the future. *Strategy Leadership* 38 (1), 22–31.

It is also important to note that authorities increasingly access the data/information they need “on demand” rather than requiring submission of data for all trade shipments being transported. The EU eFTI regulations coming into force over the coming two years are a prime example. Requiring data “on demand” will very likely also mean that concepts of Linked Data (also mentioned in the body text of this BRS) will be implemented as part of the solutions to meet the regulatory requirement.

Network improvements and optimization

Universal (real-time) track and trace capabilities will enable digital ecosystems (digital supply chains) to flourish overcoming current logistics inefficiencies.

Companies will have full visibility and sovereignty⁷⁴ of their supply chains as part of fully interconnected logistics networks so that transport assets and resources are used for optimum efficiency.

Track and Trace technologies

Tracking technologies enable firms to shift from receiving local, periodic, and static snapshots of their operations to viewing a fully instrumented and contextualized supply chain. Tracking technologies offer unique value propositions by providing information along three dimensions – context, reach and periodicity.

- **Context** is defined as information that can be used to characterize the situation of entities that are considered relevant to the interaction between a user and an application⁷⁵; context is typically considered the location, identity and state of individuals and physical objects. Tracking technologies generate this rich contextual data on supply chain resources and assets at both the point and time of action.
- **Reach** is defined as the radius of information insight and access a firm has into its supply chain. A company viewing the location of materials in-transit is better prepared to reschedule manufacturing activities based on expected availability of parts. In the supply chain context, tracking technologies have extended a firm’s reach from localized to virtually pervasive.
- **Periodicity** is defined as the frequency at which relevant supply chain information is collected and provided. Advanced, sensor-based tracking technologies can collect an enormous amount of data and provide it continuously in real-time⁷⁶.

The tracking technologies described below have different characteristics in terms of periodicity and context. All them however, focus on the “WHERE and WHEN” of a specific track and trace event. In

⁷⁴ See *JRC LIVE - Regaining supply chain sovereignty*

https://www.youtube.com/watch?v=kGuloacnsVI&list=PLxdsc7eCmCO4k8RC_PiXW_OZAEbku271&index=2.

⁷⁵ Abowd, G. D., Dey, A. K., Brown, P. J., Davies, N., Smith, M., & Steggles, P. (1999). Towards a better understanding of context and context-awareness. *Handheld and Ubiquitous Computing*, 304-307. https://doi.org/10.1007/3-540-48157-5_29.

⁷⁶ Chen, Chiang, & Storey. (2012). Business intelligence and analytics: From big data to big impact. *MIS Quarterly*, 36(4), 1165. <https://doi.org/10.2307/41703503>.

general, these technologies do not interpret or enhance the data gathered to provide a wider reach in terms of information insights.

Tracking and tracing technologies like EPCIS (see also Appendix 3) enable stakeholders to interpret multiple events in combination and thus, allow deeper insights and reach because the events that may be combined may originate from multiple different stakeholders.

The utilization of monitoring and tracking systems is essential to reduce costs and smooth identification of bottlenecks and operational defects.⁷⁷ Track-and-trace solutions can be implemented via terrestrial systems and satellite-based systems; terrestrial systems are all systems implemented on earth, whereas satellite-based systems require corresponding hardware in space.⁷⁸ The fundamental difference between terrestrial and satellite-based systems, is the number of status messages for determining the position of objects.⁷⁹

Terrestrial systems only issue status messages when individual, defined process steps are completed; such systems are referred to as process step-related or discrete track-and-trace. Discrete track-and-trace requires a line structure in which the objects to be tracked pass through individual process steps one after the other. Along this value-added chain, the exact location of an object can be determined for each step in the despatch or production process via Automatic Identification and Data Capture (AIDC or Auto-ID) technologies such as RFID, barcode or 2D code.⁸⁰ Currently, many events (and associated locations) are captured through manual operations.

The dichotomy in satellite-based systems is they identify objects continuously in real-time, which is known as continuous track-and-trace systems.⁸¹ Due to the constant technology development, track-and-trace application can be supported by both systems simultaneously and may provide a fallback feature depending on the available infrastructure.

Systems reader positioning

To gain a profound understanding about track and trace technologies, it is important to assess the way in which they are currently embedded in the context of logistics and supply chain. Auto-ID systems are considered a subsystem of logistics systems; a logistics system is defined as the transfer of cargo or persons accompanied by the flow of information.⁸² According to Shamsuzzoha et al. (2013), Auto-ID technologies enable the track-and-trace of the location of products in the supply chain. The Auto-ID system must be flexible in terms of constituting a dynamic environment, in which new nodes can be added to capture all the product information. Do et al. (2006) refer to scalability because an Auto-ID node typically collects and manages a large amount of event data, which is further growing over time.⁸³ With the integration of Auto-ID technologies in the supply chain context, processes can be optimized, the impact of human mistakes and errors minimized.⁸⁴

⁷⁷ Shamsuzzoha, A. H. M., Ehrs, M., Addo-Tenkorang, R., Nguyen, D., & Helo, P. T. (2013). Performance evaluation of tracking and tracing for logistics operations. *International Journal of Shipping and Transport Logistics*, 5(1), 31-54.

⁷⁸ Pavkovic, B., Berbakov, L., Ulianov, C., & Hyde, P. (2016). Integrated Real-Time Satellite Positioning and Communication System for Railway Applications. *3rd International Conference on Traffic and Transport Engineering*, 227-235.

⁷⁹ Deslandes, V., Tronc, J., & Luc-Beylot, A. (2010). Analysis of interference issues in integrated satellite and terrestrial mobile systems. 5th Conference of Advanced Satellite Multimedia Systems, 233-244.

⁸⁰ Klumpp, M., & Kandel, C. (2011). GPS-based Real-Time Transport Control for Production Network Scheduling Simulation. *European Simulation and Modelling Conference*, 235-239.

⁸¹ Kothris, D., Beach, M., Allen, B., & Karlsson, P. (2001). Performance assessment of terrestrial and satellite-based position location systems. *International Conference on 3G Mobile Communication Technologies*, 543-555.

⁸² Shamsuzzoha, A. H. M., Ehrs, M., Addo-Tenkorang, R., Nguyen, D., & Helo, P. T. (2013). Performance evaluation of tracking and tracing for logistics operations. *International Journal of Shipping and Transport Logistics*, 5(1), 31-54.

⁸³ Do, H. H., Anke, J., & Hackenbroich, G. (2006). Architecture evaluation for distributed Auto-ID systems. *Seventeenth International Conference on Database and Expert Systems Applications*, 30-51.

⁸⁴ Gnimpieba, D. R., Nait-Sidi-Moh, A., Durand, D., Fortin, J. (2015). Using Internet of Things Technologies for a Collaborative Supply Chain: Application to Tracking of Pallets and Containers. *10th International Conference on Future Networks and Communications*, 56, 550-557.

Outdoor and Indoor positioning technologies in Outbound logistics (the interface between the internal and external environment of a company), have to be considered, in track-and-trace of products and goods. Global Positioning System (GPS) tracking is a widely accepted and used form of outdoor tracking. Global Positioning System (GPS) tracking data are becoming ubiquitous in various transportation applications and have been widely used in collecting information on people and goods transport.^{85 86 87} In general, GPS tracking data provides information on longitude, latitude, altitude, date, time, speed, and direction of movement.⁸⁸

A GPS tracking device normally consists of three major components, in which the GPS black box is the central part of the system with a fixed interval transmission of data to a server. The GPS antenna is responsible for a strong receiving power to calculate the incoming signals. To power up the system, a battery is needed with which modern GPS modules can operate at least up to 72h. The simple and universal setup is important for the management of all involved parties in the supply chain since the signal can be integrated easily into several different data management systems.⁸⁹

In general, there is a differentiation between “event-monitoring” tracking, where the location is only tracked near a reading station, and “continuous” tracking methods, where the location can be detected any time. GPS might be able to close this gap, since its localization can be tracked anywhere and does not require a constant mobile connection, reporting its location when requested. This is valid for most outdoor environments, but it lacks in its indoor tracking capabilities within a warehouse.⁹⁰

Xu Chen, Xu and Ji (2015) conducted several experiments and found types of pseudolite architectures for the indoor usage.⁹¹ [Pseudolite is a contraction of the term "pseudo-satellite," used to refer to something that is not a satellite which performs a function commonly in the domain of satellites.⁹²] Several pseudolites are located at corners of a building to simulate satellite constellations, which are not reachable from indoor locations. A repeater simplifies the synchronization of the constellation with an indoor antenna to collect the GPS signal. This method reaches an indoor localization with only minor modifications of a commercial GPS receiver.

Tracking via the Global System for Mobile Communications (GSM) is done with the assistance of mobile telecommunication technology; therefore, the area needs to be actively covered by a GSM network in order to utilize this tracking method. The covered area is divided into a number of cells, where each cell, is served by its own base station; several base stations are combined and controlled by a mobile service centre; this serves as the interface between the mobile network and the public switching telephone network, which is the aggregate of different telephone networks of the world.⁹³

As a basis, it can be stated that track-and-trace in the indoor context of outbound logistics, is mostly applicable to distribution centres, since goods are handled in these facilities before they are shipped out to the end customer. This procedure is called indirect distribution, since the final consumer is not

⁸⁵ Furletti, B., Cintia, P., Renso, C., & Spinsanti, L. (2013). Inferring human activities from GPS tracks. *Proceedings of the 2nd ACM SIGKDD International Workshop on Urban Computing - UrbComp '13*. <https://doi.org/10.1145/2505821.2505830>.

⁸⁶ Gong, L., Morikawa, T., Yamamoto, T., & Sato, H. (2014). Deriving personal trip data from GPS data: A literature review on the existing methodologies. *Procedia - Social and Behavioral Sciences*, 138, 557-565. <https://doi.org/10.1016/j.sbspro.2014.07.239>.

⁸⁷ Sauerländer-Biebl, A., Brockfeld, E., Suske, D., & Melde, E. (2017). Evaluation of a transport mode detection using fuzzy rules. *Transportation Research Procedia*, 25, 591-602. <https://doi.org/10.1016/j.trpro.2017.05.444>.

⁸⁸ Sadeghian, P., Håkansson, J., & Zhao, X. (2021). Review and evaluation of methods in transport mode detection based on GPS tracking data. *Journal of Traffic and Transportation Engineering (English Edition)*, 8(4), 467-482. <https://doi.org/10.1016/j.jtte.2021.04.004>.

⁸⁹ Klumpp, M., & Kandel, C. (2011). GPS-based Real-Time Transport Control for Production Network Scheduling Simulation. *European Simulation and Modelling Conference*, 235-239.

⁹⁰ Kandel, C., Klumpp, M., & Keusgen, T. (2011). GPS based track-and-trace for transparent and sustainable global supply chains. *17th Conference on Concurrent Enterprising*, 1-8.

⁹¹ Xu, R., Chen, W., Xu, Y., & Ji, S. (2015). A New Indoor Positioning System Architecture Using GPS Signals. *Sensors*, 15(5), 10074-10087. <https://en.wikipedia.org/wiki/Pseudolite>.

⁹³ Hussain, M. A., & Kwak, K. S. (2009). Positioning in Wireless Body Area Network using GSM. *International Journal of Digital Content Technology and its Applications*, 3(3), 167-172.

geographically close to the factory in most cases, so that intermediaries are helping to deliver the final product. Chen (2001) simplified the role of distribution centres by referring to them as the connection point between supplying sources and the demand points of the end customer.⁹⁴

GSM is still the current standard for mobile tracking.⁹⁵ It is the most widely deployed telephony standard in the world. GSM is present in more than 220 countries with nearly 800 mobile operators. Mobile-based tracking is a form of self-positioning, also called remote positioning, due to the remote calculation of the position, utilizing the signal of the mobile to position it on the map, measuring the distances of each sender.

Barcodes

Barcodes are an important factor in today's world, extensively popular and universally recognized because of their reading speed, precision, accuracy and functionality.⁹⁶ In general, whenever a barcode is read, the status of the trade shipment can be changed to the next required action; once this is done, the ID of the person who made the change and a time stamp are stored into a database, so that transparency is increased and each handling step is documented.⁹⁷ (See also Appendix 4 - GS1 system of standards and EPCIS.)

Regarding Kandel et al. (2011), barcode tracking is part of an event-monitoring since no notifications are sent automatically to a receiver.⁹⁸ Nevertheless, barcode tracking can easily be integrated into active tracking methods, as when scanning the barcode, the trade shipment can be connected to the transportation vehicle it is loaded into. With this twist, a single barcode becomes part of consolidated trade shipments, where forms of active tracking might be applicable.⁹⁹ (See also Appendix 5 which outlines how this approach can be implemented across the supply chain between Seller and Buyer.)

Currently the most popular barcodes are the so-called linear formats like the ones you see on products in shops all over the world.

The image in Figure 32 to the right shows the first linear barcode on consumer products ever scanned at a point of sale. The number shown below the barcode is the number contained in the linear barcode and it is the so-called GTIN (GS1 Global Trade Item Number).

GS1 barcodes are scanned all over the world more than **10 billion times per day**.



Figure 32. First linear barcode on consumer products ever scanned at a point of sale, GS1

One major benefit of barcodes is the easy setup for a barcode system with just a simple smartphone camera and access to the internet. This is especially applicable to 2D barcodes.

⁹⁴ Chen, C. T. (2001). A fuzzy approach to select the location of the distribution centre. *Fuzzy Sets and Systems*, 118(1), 65-73.

⁹⁵ Tian, Y., Denby, B., Ahriz, I., Roussel, P., & Dreyfus, G. (2015). Robust indoor localization and tracking using GSM fingerprints. *Journal on Wireless Communications and Networking*, 2015(1), 1-12.

⁹⁶ M'hand, M. A., Boulmakoul, A., Badir, H., & Lbath, A. (2019). A scalable real-time tracking and monitoring architecture for logistics and transport in RoRo terminals. *Procedia Computer Science*, 151, 218-225.

⁹⁷ Vartiainen, J., Kallonen, T., & Ikonen, J. (2008). Barcodes and Mobile Phones as Part of Logistic Chain in Construction Industry. *International Conference on Software, Telecommunications and Computer Networks*, 304-307.

⁹⁸ Kandel, C., Klumpp, M., & Keusgen, T. (2011). GPS based track-and-trace for transparent and sustainable global supply chains. *17th Conference on Concurrent Enterprising*, 1-8.

⁹⁹ Shuyi, Q., Zhiqiang, W., & Yongquan, Y. (2013). Research on Vegetable Supply Chain Traceability Model Based on Two-Dimensional Barcode. *6th International Conference on Computational Intelligence and Design*, 1, 317-320.

2D barcodes (e.g., QR and DataMatrix)

Shuyi et al. (2013) talk about the new generation of 2D barcodes (e.g., QR codes, DataMatrix, PDF417), which consist of a black and white matrix in which information is encoded using small squares. 2D barcodes have a hundred times more capacity than linear barcodes, have error correction capability and information can be stored in vertical as well as horizontal directions¹⁰⁰.

One major advantage of the 2D barcodes is that they can contain many different data elements (e.g., delivery location information next to unique transport unit ID, trade shipment ID, seller ID, and buyer ID). All that information can be read and interpreted in a single barcode-scan using global data standards such as described in [the GS1 Scan4Transport guidelines](#)¹⁰¹.

The QR barcode in Figure 33 to the right is compliant with these Scan4Transport guidelines and contains among other things the transport unit ID, trade shipment ID, consignment ID, postal code, address details, geo-coordinates as well as the name of the recipient and the sender.

This barcode would be available on the transport unit and may be scanned by any stakeholder handling the transport unit and then correctly interpreted based on the Scan4Transport guidelines. The basis for that is “Application Identifiers” (AI). They are standard numeric “tags” that identify how the actual value that follows the AI is to be interpreted. For example, AI “00” indicates the next value is an SSCC (the identifier for the transport unit) and AI “420” indicates the next value is “Ship to / Deliver to postal code within a single postal authority”¹⁰².



Figure 33. 2-D Barcode example, GS1

You may scan this barcode using <https://gs1.github.io/S4T/mobile.htm> to view the contents in a user-friendly format. The page also enables you to then view the delivery location on OpenStreetMap.

A variety of barcode sizes are available ranging from Micro QR codes to 177 x 177 modules, utilizing four encoding modes, that is Numeric, Alphanumeric, Binary/byte and Kanji.¹⁰³ The size of the 2D barcode is often chosen dependent on the available space of the product or object, so that Micro QR codes are often seen on small electronic components. Sensitive information can be stored into secured 2D barcodes, where the access is limited. Also, the possibility of frame QR codes exist, which gives companies the possibility to visually individualize their QR code to be easily recognized. This is mostly done in advertising and does not seem to be relevant for track-and-trace purposes (Rajesh, Waranalatha, Reddy & Supraja, 2018).¹⁰⁴ Currently, coloured QR codes with more data storing opportunities are developed, but this technology is not ready for the universal mass application yet.

¹⁰⁰ Saroj Goyal, Dr. Vinod Kumar, Dr. Surendra Yadav, Manish Mathuria, (2015). Quick Response Code Implementation in Society, INTERNATIONAL JOURNAL OF ENGINEERING RESEARCH & TECHNOLOGY (IJERT) ATCSMT – 2015 (Volume 3 – Issue 31).

¹⁰¹ GS1 Scan4Transport: Linking the Parcel to its Digital Twin.

¹⁰² <https://www.gs1.org/standards/barcodes/application-identifiers>.

¹⁰³ Saroj Goyal et al. (2015).

¹⁰⁴ Rajesh, K., Waranalatha, S. S., Reddy, K. V. M., & Supraja, M. (2018). QR Code-Based Real Time Vehicle Tracking in Indoor Parking Structures. *2nd International Conference on Intelligent Computing and Control Systems*, 151-161.

In the case of Wang, Hung-Lin, Shou and Wang (2018), several barcodes for different processing steps have been used to track single items.¹⁰⁵ Therefore, the usage of different barcodes allows to separate the information of a trade shipment completely to ensure data security. Nevertheless, the test also revealed that these barcodes should be easily separable so that it is clearly visible which barcode is relevant for each processor of the trade shipment to keep the productivity high. Additionally, the readability of the 2D barcode is enhanced since it can be recognized correctly even if the scanning misses up to 50% of the small constituent squares.

The creation of a unique 2D barcode is simple and at low cost with the help of electronic generators. As the barcode-image only consists of black and white, printing costs can be limited. With this setup, costs can be decreased and a tracking system with an acceptable security level can be implemented.¹⁰⁶

Barcode Quality

Vartiainen et al. (2008) conducted experiments, which concluded that barcode identification with a regular cell phone camera is applicable to situations where sufficient light is available.¹⁰⁷ Also, the accessibility is important since a sufficiently correct angle between the reader and the barcode is needed to enhance the readability. This goes in line with the conducted tests of Billo, David Porter, Mazumdar and Brown (2003), where seven independent variables of the bar code quality were tested.¹⁰⁸ Only the X-dimension (ideal width), the bar growth/reduction as well as the symbol contrast seemed to matter in the fast readability of these codes. Once taking these factors into account, barcodes can easily be read by a manual scanner or a fully automatic reading machine.

Another benefit is the universal application of barcodes as in the example of M'hand, Boulmakoul, Badir and Lbath (2019). In a challenging environment for localization technologies like within ferries, where the high density of metal makes the localization with advanced tracking technologies difficult, an easy arrangement might meet the requirements if no real-time localization is needed.¹⁰⁹

Wang et al. (2018) point out that one downside of barcodes is that they are easily damaged as they are exposed to wear and tear. Once a linear barcode is ripped or damaged, there is no way to scan or update the status of the product.¹¹⁰ He therefore recommends a plastic protective layer around it once it becomes obvious that the product is at risk of being damaged. In his example he calculated that even with a 1% rate of ripped barcodes, labelling could still be beneficial for the overall revenue generation. As mentioned above, 2D barcodes are much less susceptible to damage and can nearly always be read.

Once the barcode is scanned, all relevant information can be displayed immediately, and no manual entries need to be made to have access to the relevant information.

RFID - Radio Frequency Identification

¹⁰⁵ Wang, J., Hung-Lin, C., Shou, W., & Wang, X. (2018). A Coordinated Approach for Supply-Chain Tracking in the Liquefied Natural Gas Industry. *Sustainability*, 10(12), 41-49.

¹⁰⁶ Melgar, M. E. V., & Melgar Santander, L. A. (2014). An alternative proposal of tracking products using digital signatures and QR codes. *IEEE Colombian Conference on Communications and Computing*, 389-399.

¹⁰⁷ Vartiainen, J., Kallonen, T., & Ikonen, J. (2008). Barcodes and Mobile Phones as Part of Logistic Chain in Construction Industry. *International Conference on Software, Telecommunications and Computer Networks*, 304-307.

¹⁰⁸ Billo, R. E., David Porter, J., Mazumdar, M., & Brown, S. J. (2003). Impact of bar code print quality on the performance of high-speed sortation systems. *Journal of Manufacturing Systems*, 22(4), 317-326.

¹⁰⁹ M'hand, M. A., Boulmakoul, A., Badir, H., & Lbath, A. (2019). A scalable real-time tracking and monitoring architecture for logistics and transport in RoRo terminals. *Procedia Computer Science*, 151, 218-225.

¹¹⁰ Wang, J., Hung-Lin, C., Shou, W., & Wang, X. (2018). A Coordinated Approach for Supply-Chain Tracking in the Liquefied Natural Gas Industry. *Sustainability*, 10(12), 41-49.

Radio Frequency Identification (RFID) technology is one of the pivotal enablers of the Internet of Things,¹¹¹ which is common technology used for tracking and tracing of goods, assets and flows in a logistics system.¹¹² RFID technology offers several contributions to supply chain, through advanced properties such as unique identification of products, tracking of items as they move through the supply chain, ease of communication and real-time information.¹¹³ RFID technology shares information with business partners, allowing collaboration on various supply chain processes, such as inventory management, transportation management, planning, forecasting, production scheduling, replenishment and asset management systems.¹¹⁴ RFID tags support a larger set of unique IDs than barcodes and can incorporate additional data such as manufacturer, product type and even measure environmental factors such as temperature.¹¹⁵ Moreover, RFID can improve the traceability of products and the visibility throughout the entire supply chain. RFID can also speed up and make more reliable operational processes, such as tracking, shipping, checkout and counting processes, which leads to greater inventory flows and more accurate information.¹¹⁶

RFID is a wireless automatic identification and data acquisition (AIDC) technology.¹¹⁷ It employs radio frequency waves to transfer data between a reader and an item that is to be identified, tracked, or located.¹¹⁸ RFID may be utilized to track trade shipments, consignments, transport units, trade items, transport equipment and many more different objects that may be tagged. Unlike other technologies such as barcode systems, RFID identifies objects from a distance and does not require a direct line of sight. Thus, it can be utilized in visually and environmentally challenging conditions¹¹⁹.

The identification is contactless with the resonance or reflection principle by electromagnetic or magnetic (inductive) coupling. Depending on the RFID frequency (near field or far field), the coupling element consists of a dipole antenna or antenna coil.¹²⁰

RFID Tag Types

RFID tags can be divided into three different systems - active, passive and semi-passive RFID tags (Choy & Ng, 2006; Xiao, Yu, Wu & Ni, 2007; Heidrich, Brenk, Essel, Schwarzer, Seemann, et al. 2010).^{121 122}
¹²³ Xiao et al. (2007) mention that passive RFID tags do not require batteries or maintenance.

Passive RFID tags are inductively coupled, powered and received by an electromagnetic field generated by the reader. More precisely, data transmission is achieved by inductive coupling between the coil in the reader and the tiny coil in the tag. Passive RFID tags store the energy they receive until there is enough energy for the tag to transmit data (Heidrich et al., 2010). A clear advantage of passive

¹¹¹ Sandner, U., Leimeister, J.M., Krcmar, H., 2006. Business potentials of ubiquitous computing, in: *Managing Development and Application of Digital Technologies*. Springer, pp. 277–291.

¹¹² Casella, G., Bigliardi, B., & Bottani, E. (2022). The evolution of RFID technology in the logistics field: A review. *Procedia Computer Science*, 200, 1582-1592. <https://doi.org/10.1016/j.procs.2022.01.359>.

¹¹³ Ibid.

¹¹⁴ Vijayaraman B. and Osyk B. (2006) "An empirical study of RFID implementation in the warehousing industry" *The International Journal of Logistics Management* 17(1): 6-20.

¹¹⁵ Want R. (2006) "An introduction to RFID technology" *IEEE Pervasive Computing* 5(1): 25-33.

¹¹⁶ Sarac A., Absi N. and Dauzere-Pérès S. (2010) "A literature review on the impact of RFID technologies on supply chain management" *International Journal of Production Economics*, 128(1): 77-95.

¹¹⁷ Wu, C.; Wang, X.; Chen, M.; Kim, M.J. (2019). Differential received signal strength based RFID positioning for construction equipment tracking. *Advanced Engineering Informatics*. 42, 100960.

¹¹⁸ Claesson, F., Hilletoft, P. (2011). In-transit distribution as a strategy in a global distribution system. *International Journal of Shipping and Transport Logistics* 3, 198–209.

¹¹⁹ Roberts, C.M. (2006). Radio frequency identification (rfid). *Computers & security* 25, 18–26.

¹²⁰ Anandhi, S., Anitha, R., & Sureshkumar, V. (2019). IoT Enabled RFID Authentication and Secure Object Tracking System for Smart Logistics. *Wireless Personal Communications*, 104(2), 543-560.

¹²¹ Choy, K. L., & Ng, S. W. K. (2006). Improving supply chain traceability with the integration of logistics information system and RFID technology. *Advances in Materials Manufacturing Science and Technology*, 1092, 532-533.

¹²² Xiao, Y., Yu, S. H., Wu, K., Ni, Q., Janecek, C., & Nordstad, J. (2007). Radio frequency identification: technologies, applications, and research issues. *Wireless Communications & Mobile Computing*, 7(4), 457-472.

¹²³ Heidrich, J., Brenk, D., Essel, J., Schwarzer, S., Seemann, K., Fischer, G., & Weigel, R. (2010). The Roots, Rules, and Rise of RFID. *IEEE Microwave Magazine*, 11(3), 78-86.

tags is that they are smaller, lighter, and less expensive than active tags. However, due to the inductive coupling they can only be read from short distance of up to 3 meters (Xiao et al., 2007). Passive RFID tags also have an indefinite operational life and due to their small size, they fit into a practical adhesive label (Choy et al., 2006, Lu et al., 2018¹²⁴).

According to Heidrich et al. (2010) active RFID tags, unlike passive RFID tags, can send data in predefined time intervals because they have their own power supply (battery). This enables them to communicate data at a higher range of up to 100 meters. Anandhi et al. (2019) mention that active RFID tags are predestined for indoor localization. Active RFID tags offer an integrated sensor technology (position, acceleration, pressure, temperature, charge level) that enables additional information transfer about the tagged object. The advantages of active RFID tags are characterized by their easy programmability and integration. However, the costs factor and installation effort are still downsides that must be considered. Cost effectiveness can only be reached by purchasing large amounts (Xiao et al., 2007).¹²⁵

Semi-passive tags have a power source which increases their working range and throughput. The main difference between active and semi-passive tags is that semi-passive tags still require a passive response from the RFID tag to the reader (Choy et al., 2006; Kiraly, Helfenbein, Kiraly, Kovacs & Balla, 2017).¹²⁶¹²⁷

GS1 provides standards for encoding the information in the RFID tags. Most passive RFID tags nowadays are so-called generation 2 (Gen2) tags and are based on GS1 standards. These Gen 2 tags allow non-GS1 identifiers to be used within the RFID tags, meaning that everyone may use Gen 2 tags without using any of the GS1 identifiers. e.g., you may include a BIC container code in a Gen 2 standard RFID tag.¹²⁸

W-LAN Tracking

Since GPS tracking is hardly applicable to complex indoor environments, alternative active tracking methods have to be considered which allow for real-time localization. Wide Local Area Network (W-LAN) localization techniques in general utilize metrics of received radio signals. Some common wireless localization methodologies developed over the years are below.

Angle of Arrival (AoA) methodology is mostly suitable for areas that there is a direct line of sight between mobile user (MU) and reference points (RP). Location is calculated by measuring the angle between a line that runs from the RP to the MU and a line from the RP with a predefined direction.¹²⁹ Despite in areas of direct line of sight being sustained, providing very accurate results, the biggest disadvantage of this methodology is the need of special RPs that can sense the exact direction of the received signal.

Time of Arrival (ToA) methodology is based on the measurement of the amount of time required for a signal to travel from an MU to one or more RPs.¹³⁰ This amount of time is named propagation delay and the distance between an MU and a RP can be determined by this method. The method uses the

¹²⁴ Lu, X., Wang, L. P., Zhao, D. D., & Zhai, C. (2018). Multi-tag RFID System Enables Localization and Tracking. *International Conference on Computer Information Science and Application Technology*, 7, 201-219.

¹²⁵ Xiao, Y., Yu, S. H., Wu, K., Ni, Q., Janecek, C., & Nordstad, J. (2007). Radio frequency identification: technologies, applications, and research issues. *Wireless Communications & Mobile Computing*, 7(4), 457-472.

¹²⁶ Choy, K. L., & Ng, S. W. K. (2006). Improving supply chain traceability with the integration of logistics information system and RFID technology. *Advances in Materials Manufacturing Science and Technology*, 1092, 532-533

¹²⁷ Kiraly, R., Helfenbein, T., Kiraly, S., Kovacs, E., & Balla, T. (2017). Novel concepts and devices in RFID based indoor localization using Smart Reader Networks and Intelligent Antennas. *Infocommunications Journal*, 9(2), 15-24.

¹²⁸ https://www.gs1.org/sites/default/files/docs/epc/GS1_EPC_TDS_i1_12.pdf#page=39

¹²⁹ Nanotron Technologies GmbH. (2007). "Real Time Location Systems (RTLS)", NA-06-0148-0391-1.02.

¹³⁰ Kul, G., Özyer, T., & Tavli, B. (2014). IEEE 802.11 WLAN based real time indoor positioning: Literature survey and experimental investigations. *Procedia Computer Science*, 34, 157-164. <https://doi.org/10.1016/j.procs.2014.07.078>.

absolute time it takes until the synchronous signal is received, whereas the time difference of arrival approach uses the time difference between sending and receiving the signal as the basis.¹³¹

Another important tracking technology for W-LAN is the trilateration method. The distance from several W-LAN access points to the trackable device is measured.¹³² The accuracy is improved with more access points in direct line-of-sight to which the trackable device can build up a connection. More access points are equivalent to more data about the physical distance to different routers which can be measured (Torteeka et al., 2014). Xiang, Song, Chen, Wang and Huang et al. (2004) on the other hand found out that after more than 100 measurements, the accuracy of their tracking system was not remarkably improved with further entries during the setup phase.¹³³ This indicates that there is a threshold of how much data should be processed. The downside is that the accuracy of the method is easily affected by noise and the impact of closely located electronic devices, which is counterproductive for a tracking method in the context of a warehouse. The experiments were conducted in a direct line-of-sight to the receiver, which would be additionally challenging for this tracking method once this parameter of the test setup would be changed to the reality of a warehouse.¹³⁴ Regarding Han and He (2018) most of the currently used indoor positioning methods are based on the received signal strength fingerprint recognition algorithm and are therefore called fingerprinting localization.¹³⁵ This algorithm creates a database of the designated location area signal strength and compares it to the real-time collected signal strength. With this method, an accurate location estimation can be achieved. It does not require line-of-sight measurement to the sending nodes, which is beneficial in complex environments, where the line-of-sight can be easily blocked. In general, the system works well with unchanged environments, where influencing factors stay constant over time.

This technique consists of two phases. During the offline phase, a database or radio map of reference points is created, which serves as the basis for future localizations. During the online phase, the location would be obtained by using pattern-matching algorithms, which compare real time signal strengths with those recorded during the offline phase.¹³⁶ The overall fingerprint location technology is further divided into two categories. The first type would be the positioning method using an average of the signal strength for each access point, so that the user location can be estimated using a reasoning algorithm. The second type is a probability-based localization method, where conditional probability is used in order to estimate the user's position (Han et al., 2018).¹³⁷ Advanced forms of fingerprinting localization methods use context-aware information, such as a site plan, to reduce the special density of required wireless access points.¹³⁸ In some conducted experiments by Izquierdo, Ciurana, Barcelo, Paradells and Zola (2006), the time-of-arrival data was used to estimate a position.¹³⁹ Time-of-arrival is part of the round-trip measurement and therefore, a set of estimations with zero distance had to be obtained. An average measurement error of 0.64m regarding all cases could be

¹³¹ Heidari, M., & Pahlavan, K. (2008). Performance evaluation of Wi-Fi RFID localization technologies. *Technology and Applications*, 74-86. Cambridge: Cambridge Univ Press.

¹³² Torteeka, P., Xiu, C. D., & Yang, D. K. (2014). Hybrid Technique for Indoor Positioning System based on Wi-Fi Received Signal Strength Indication. *International Conference on Indoor Positioning and Indoor Navigation*, 344-367.

¹³³ Xiang, Z., Song, S., Chen, J., Wang, H., Huang, J., & Gao, X. (2004). A wireless LAN-based indoor positioning technology. *IBM Journal of Research and Development*, 48(5 6), 617-628.

¹³⁴ Khan, M., Kai, Y. D., & Gul, H. U. (2017). Indoor Wi-Fi positioning algorithm based on combination of Location Fingerprint and Unscented Kalman Filter. *14th International Bhurban Conference on Applied Sciences and Technology*, 667-672.

¹³⁵ Han, X., & He, Z. W. (2018). A Wireless Fingerprint Location Method Based on Target Tracking. *12th International Symposium on Antennas, Propagation and Electromagnetic Theory*, 4, 111-124.

¹³⁶ Chirakkal, V. V., Myungchul, P., & Dong Seog, H. (2014). Navigating through dynamic indoor environments using WI-FI for smartphones. *IEEE International Conference on Consumer Electronics*, 2015, 376-378.

¹³⁷ Han, X., & He, Z. W. (2018). A Wireless Fingerprint Location Method Based on Target Tracking. *12th International Symposium on Antennas, Propagation and Electromagnetic Theory*, 4, 111-124.

¹³⁸ D'Souza, M., Schoots, B., & Ros, M. (2016). Indoor position tracking using received signal strength-based fingerprint context aware partitioning. *IET Radar Sonar and Navigation*, 10(8), 1347-1355.

¹³⁹ Izquierdo, F., Ciurana, M., Barcelo, F., Paradells, J., & Zola, E. (2006). Performance evaluation of a TOA-based trilateration method to locate terminals in WLAN. *International Symposium on Wireless Pervasive Computing*, 217-222.

achieved, when factors about the area have been considered. Therefore, W-LAN tracking is never an off-the-shelf solution but an individualized product. In the harder-to-locate environment of Jathe, Lutjen and Freitag (2019), an average location accuracy of 2,33m with the best possible algorithm combination could be achieved.¹⁴⁰

The results of Xiang et al. (2004) are going into the same direction, which proves that the development of an adjusted algorithm can significantly improve the results of the tracking system. Since the tracking accuracy was within 4m in 95% of all cases, this method of tracking is applicable for the practical commercial use if this range is enough for the purpose of the business.¹⁴¹ In related papers, localization is done with the help of a grid, where vectors are pointing toward the place where the requested position can be localized. This form of tracking is mostly useful in undistracted environments, where less distractions are taking place and therefore less suitable for track-and-trace in the context of logistics.¹⁴² Torteeka et al. (2014) conducted an experiment, where they combined the W-LAN trilateration technique with the fingerprint method.¹⁴³ With this approach the positioning accuracy could be improved, the tracking system became more robust and the approximate positioning is continuous. Hence, this shows that once techniques are combined, a robust solution can be developed, which can mitigate the downsides of each tracking technique.

In the work of Kirsch, Miesen and Vossiek (2014) as well as related papers regarding the Internet of Things, W-LAN is often used to transport information to a central server for further processing.¹⁴⁴ This type of connection to a mobile phone or a different device cannot be seen as a tracking technique, since only information is exchanged and the method is not used for location purposes. In these setups, W-LAN is part of a hybrid localisation technique but not the source of localisation. One further example would be the wireless pick-by-light system of Asghar, Lutjen, Rohde, Lembke and Freitag (2018), where W-LAN is used to establish a more inexpensive form of a picking system with optimized routes.¹⁴⁵ It becomes clear that fingerprinting tracking as well as the trilateration method are the ones suitable for indoor tracking in a logistical context (Torteeka et al., 2014).¹⁴⁶ Hybrid approaches are emerging ideas, which require more work to detect their full potential.

UWB Tracking

Indoor positioning is often characterized by a high demand for precision and accuracy and can be affected by a variety of objects and signals. In recent years, Ultra-Wide Band (UWB) gained increased interest in indoor positioning, because it enables highly accurate positioning.¹⁴⁷ Zuin, Calzavara, Sgarbossa and Persona (2018) defined UWB as a radio frequency technology that spreads information out over a wide spectrum of radio frequencies.¹⁴⁸ This enables UWB to transmit a large variety of data while consuming only little energy (Alarifi et al., 2016). Promwong and Southisombat (2016)

¹⁴⁰ Jathe, N., Lutjen, M., & Freitag, M. (2019). Indoor Positioning in Car Parks by using Wi-Fi Round-Trip-Time to support Finished Vehicle Logistics on Port Terminals. *Ifac Papersonline*, 52(13), 857-862.

¹⁴¹ Xiang, Z., Song, S., Chen, J., Wang, H., Huang, J., & Gao, X. (2004). A wireless LAN-based indoor positioning technology. *IBM Journal of Research and Development*, 48(5 6), 617-628.

¹⁴² Smallbon, V., Potie, T., D'Souza, M., Postula, A., & Ros, M. (2015). Implementation of Radio Tomographic Imaging based Localisation using a 6LoWPAN Wireless Sensor Network. *12th International Joint Conference on E-Business and Telecommunications*, 6, 27-32.

¹⁴³ Torteeka, P., Xiu, C. D., & Yang, D. K. (2014). Hybrid Technique for Indoor Positioning System based on Wi-Fi Received Signal Strength Indication. *International Conference on Indoor Positioning and Indoor Navigation*, 344-367.

¹⁴⁴ Kirsch, F., Miesen, R., & Vossiek, M. (2014). Precise Local-Positioning for Autonomous Situation Awareness in the Internet of Things. *IEEE International Microwave Symposium*, 4, 243-261.

¹⁴⁵ Asghar, U., Lutjen, M., Rohde, A. K., Lembke, J., & Freitag, M. (2018). Wireless Pick-by-Light: Usability of LPWAN to Achieve a Flexible Warehouse Logistics Infrastructure. *Dynamics in Logistics*, 273-283.

¹⁴⁶ Torteeka, P., Xiu, C. D., & Yang, D. K. (2014). Hybrid Technique for Indoor Positioning System based on Wi-Fi Received Signal Strength Indication. *International Conference on Indoor Positioning and Indoor Navigation*, 344-367.

¹⁴⁷ Alarifi, A., Al-Salman, A., Alsaleh, M., Alnafessah, A., Al-Hadhrami, S., Al-Ammar, M. A., & Al-Khalifa, H. S. (2016). Ultra Wideband Indoor Positioning Technologies: Analysis and recent advances. *Sensors*, 16, 36.

¹⁴⁸ Zuin, S., Calzavara, M., Sgarbossa, F., Persona, A. (2018). Ultra Wide Band Indoor Positioning System: analysis and testing of an IPS technology. *Ifac Papersonline*, 51(11), 1488-1492.

additionally mention that the time difference of arrival can be used with UWB to determine the distance between the reference point and the target.¹⁴⁹

According to Pourhomayoun, Zhanpeng and Fowler (2012) UWB is defined as a baseband, impulse, and carrier-free technology.¹⁵⁰ UWB radio communicates with high-speed data rates in the respective area by transmitting extremely short pulses of radio signals (Alarifi et al., 2016). Thus, the high bandwidth of UWB offers the possibility to transmit a huge amount of data and the low frequency of UWB enables this technology to overcome the indoor positioning challenges of signal interferences through obstacles such as objects and walls. According to Pahlavan, Krishnamurthy and Beneat (1998) the high accuracy of UWB is very suitable for the tracking of different applications, such as mobile devices and humans in an indoor environment.¹⁵¹ The literature reveals different features of UWB positioning. Alarifi et al. (2016) state that UWB can also be used for the transmission of near-field data. As already mentioned, the high bandwidth and the extremely short pulses enable the signals to pass through obstacles and reduce the impact of signal interferences. This makes UWB a possible solution for indoor positioning in comparison to other technologies (Bastida-Castillo, Gomez-Carmona, De la Cruz Sanchez, Reche-Royo, Ibanez et al., 2019¹⁵²; Alarifi et al., 2016). Furthermore, UWB provides a high accuracy rate that enables positioning within three to seven centimetres. Therefore, UWB is mainly suitable for indoor locations that require a highly accurate positioning.

In contrast to other positioning technologies such as W-LAN and barcodes, UWB transmits data over distance without requiring a direct line-of-sight. Furthermore, it is not affected by noises or other devices due to its high bandwidth of radio signals. A drawback of UWB is that the investment and installation costs for UWB are relatively high in comparison to other technologies. This is due to the fact, that UWB localisation requires at least three receivers to receive signal strength at any given time. These readers are expensive and must be precisely synchronized down to a nanosecond to accurately calculate the location. Moreover, the installation effort is increased, because to keep the readers synchronized, they are often connected by cables (Pourhomayoun et al., 2012).¹⁵³ Thus, when considering Ultra-wideband as a track-and-trace solution, it should be carefully evaluated, whether a highly precise positioning is necessary due to the high investment costs.

Bluetooth-based tracking

Regarding Yang, Poellabauer, Mitra and Neubecker (2020), bluetooth-based indoor localization is a long existing approach.¹⁵⁴ Bluetooth classic was the utilized technology of position determination originally. However, due to its inefficiency, this technology has not been widely used in the past, because the length of the connection process between the devices required too much time. With the development of the Bluetooth 4.0 (including Bluetooth Low Energy (BLE) the situation changed significantly. BLE is characterized by a relatively low energy consumption and the configuration options enable a more efficient positioning in comparison to the previously mentioned W-LAN-positioning. According to Kriz, Maly and Kozel (2016), BLE is an emerging wireless technology for short-

¹⁴⁹ Promwong, S., & Southisombat, P. (2016, Dec 14-17). UWB Transmission Measurement and Modeling for Indoor Localization. *20th International Conference of Computer Science and Engineering*, 787-788.

¹⁵⁰ Pourhomayoun, M., Zhanpeng, J., & Fowler, M. (2012). Spatial sparsity based indoor localization in wireless sensor network for assistive healthcare. *International Conference of Engineering in Medicine and Biology*, 3696-3699.

¹⁵¹ Pahlavan, K., Krishnamurthy, P., & Beneat, A. (1998). Wideband radio propagation modeling for indoor geolocation applications. *IEEE Communications Magazine*, 36(4), 60-65.

¹⁵² Bastida-Castillo, A., Gomez-Carmona, C. D., De la Cruz-Sanchez, E., Reche-Royo, X., Ibanez, S. J., & Ortega, J. P. (2019). Accuracy and Inter-Unit Reliability of Ultra-Wide-Band Tracking System in Indoor Exercise. *Applied Sciences-Basel*, 9(5), 11.

¹⁵³ Pourhomayoun, M., Zhanpeng, J., & Fowler, M. (2012). Spatial sparsity based indoor localization in wireless sensor network for assistive healthcare. *International Conference of Engineering in Medicine and Biology*, 3696-3699.

¹⁵⁴ Yang, J., Poellabauer, C., Mitra, P., & Neubecker, C. (2020). Beyond beaconing: Emerging applications and challenges of BLE. *Ad Hoc Networks*, 97, 12-23.

range communication that is designed as a low-power solution for control and monitoring applications.¹⁵⁵

Bluetooth is an already widely established technology (e.g. in mobile phones, laptops, automobiles, etc.) and can thus benefit the implementation of BLE.¹⁵⁶ BLE beacons can be considered as the most established BLE applications (Faragher & Harle, 2015). They are small devices that are used to illuminate the respective area by continuously broadcasting a signal to nearby BLE receivers. This enables devices such as smartphones or tablets to send or receive data packages when they are close to one or several beacons. The usage of BLE beacons is very suitable for indoor positioning and navigation of people in indoor environments.¹⁵⁷ Vasconcelos, Figueiredo, Almeida and Ferreira (2017) mention that the downsides of the adoption of BLE include the lack of support for large and dynamic data transmissions, security and privacy concerns and interoperability with other wireless technologies.¹⁵⁸ According to Dalkilic et al. (2017), localization within buildings is often determined by W-LAN networks.¹⁵⁹ Due to the often-complex structure of a building W-LAN signals can usually not cover all areas, which results in positioning inefficiencies. Kriz et al. (2016) agree and propose that these areas can be additionally covered by additional BLE beacons.¹⁶⁰ BLE beacons are characterized by their relatively low price, small size and independence of an external power supply. Thus, they can be considered as a possible supplement to an existing W-LAN network. However, a high density of BLE beacons is needed to fully cover an area, which results in high investment costs (Yang et al., 2020).¹⁶¹ Hence, areas covered with weak W-LAN signal can be additionally illuminated by BLE beacons.

Cost Considerations in Tracking Solutions

This literature focuses on several factors, which are generally influential for the efficient performance of outbound logistical flows. One basic influencing factor is the price of the goods to be tracked as well as the logistical costs connected with the tracking solutions chosen. If these figures take up a big proportion of the total costs, a transparent supply chain becomes a key issue, which is worth investing in.¹⁶² The quantity of trade shipments is of importance once outbound trade shipments can be tracked efficiently.

Additionally, the characteristics of the tracked outbound trade shipment are highly relevant. One example given by Ling and Huang (2019) are the requirements for food trade shipments and the connected benefits of this excessive tracking.¹⁶³ These products are not high in value but need extensive tracking to guarantee food safety. The same applies for critical safety equipment, where quality issues become a matter of life and death as experienced during the COVID-19 pandemic.

¹⁵⁵ Kriz, P., Maly, F., & Kozel, T. (2016). Improving Indoor Localization Using Bluetooth Low Energy Beacons. *Journal of Mobile Information Systems*, 4-11.

¹⁵⁶ Gomez, C., Oller, J., & Paradells, J. (2012). Overview and evaluation of Bluetooth Low Energy: An Emerging Low-Power Wireless Technology. *Sensor* 12(12), 11734- 11753.

¹⁵⁷ Faragher, R., & Harle, R. (2015). Location Fingerprinting with Bluetooth Low Energy Beacons. *IEEE Journal on selected areas in communication*, 33, 2418-2427.

¹⁵⁸ Vasconcelos, F., Figueiredo, L., Almeida, A., & Ferreira, J. C. (2017). SMART Sensor Network with Bluetooth Low Energy and CAN-BUS. *IEEE International Conference on Service Operations and Logistics, and Informatics*, 217-222.

¹⁵⁹ Dalkilic, F., Cabuk, U. C., Arikan, E., & Gurkan, A. (2017). An Analysis of the Positioning Accuracy of iBeacon Technology in Indoor Environments. *International Conference on Computer Science and Engineering*, 549-553.

¹⁶⁰ Kriz, P., Maly, F., & Kozel, T. (2016). Improving Indoor Localization Using Bluetooth Low Energy Beacons. *Journal of Mobile Information Systems*, 4-11.

¹⁶¹ Yang, J., Poellabauer, C., Mitra, P., & Neubecker, C. (2020). Beyond beaconing: Emerging applications and challenges of BLE. *Ad Hoc Networks*, 97, 12-23.

¹⁶² Marques, A., Soares, R., Santos, M. J., & Amorim, P. (2020). Integrated planning of inbound and outbound logistics with a Rich Vehicle Routing Problem with backhauls. *Omega-International Journal of Management Science*, 92, 18-24.

¹⁶³ Ling, W., & Huang, L. (2019). Study on the Food Logistics and Food Safety Traceability System Design Based on Information Tracking. *Archivos Latinoamericanos De Nutricion*, 69(1), 239-247.

Hassan et al. (2015) looked at several factors in more detail and identified six broad categories of hindering factors once analysing the implementation of Auto-ID systems.¹⁶⁴ Besides the mentioned categories, technological issues play a key role. The connection to external partners as well as their own IT capabilities could be limiting factors. This is closely related to currently used tracking applications and technologies, given that they might be easily expandable. This also minimizes implementation costs, which make more sophisticated tracking solutions appealing to top management.

Recent studies have been done to prove the cost-effectiveness of a secure track and trace system,¹⁶⁵ where the proposed criteria for an RFID-based traceability system evaluation¹⁶⁶ addressed the costs and benefits of an RFID-based system for crankshaft traceability,¹⁶⁷ and developed an approach to predict traceability performance in agriculture food supply chains.¹⁶⁸ Also, evaluation methods were developed and experimental evaluations were conducted of an IoT-based cyber-physical system prototype,¹⁶⁹ and validated the effectiveness of a Web-based platform for eco-sustainable supply chain management with tracing capabilities, while contributing to overcoming the lack of quantitative tools to support companies, along with monitoring and improving the environmental impact along the production chain.¹⁷⁰

¹⁶⁴ Hassan, M., Ali, M., Aktas, E., & Alkayid, K. (2015). Factors affecting selection decision of auto-identification technology in warehouse management: An International Delphi study. *Production Planning & Control*, 26(12), 1025-1049.

¹⁶⁵ Shi, J., Li, Y., He, W., & Sim, D. (2012). SecTTS: A secure track & trace system for RFID-enabled supply chains. *Computers in Industry*, 63(6), 574-585. <https://doi.org/10.1016/j.compind.2012.03.006>.

¹⁶⁶ Feng, J., Fu, Z., Wang, Z., Xu, M., & Zhang, X. (2013). Development and evaluation on a RFID-based traceability system for cattle/beef quality safety in China. *Food Control*, 31(2), 314-325. <https://doi.org/10.1016/j.foodcont.2012.10.016>.

¹⁶⁷ Segura Velandia, D. M., Kaur, N., Whittow, W. G., Conway, P. P., & West, A. A. (2016). Towards industrial Internet of things: Crankshaft monitoring, traceability and tracking using RFID. *Robotics and Computer-Integrated Manufacturing*, 41, 66-77. <https://doi.org/10.1016/j.rcim.2016.02.004>.

¹⁶⁸ Chen, R. (2017). An intelligent value stream-based approach to collaboration of food traceability cyber physical system by fog computing. *Food Control*, 71, 124-136. <https://doi.org/10.1016/j.foodcont.2016.06.042>.

¹⁶⁹ Tu, M., K. Lim, M., & Yang, M. (2018). IoT-based production logistics and supply chain system – Part 2. *Industrial Management & Data Systems*, 118(1), 96-125. <https://doi.org/10.1108/imds-11-2016-0504>.

¹⁷⁰ Papetti, A., Marconi, M., Rossi, M., & Germani, M. (2019). Web-based platform for eco-sustainable supply chain management. *Sustainable Production and Consumption*, 17, 215-228. <https://doi.org/10.1016/j.spc.2018.11.006>.

APPENDIX 6

Tracking and Tracing Considerations for Bulk

In the world of bulk shipments, there is a clear distinction made by industry in the transport modes used, how loose raw materials and natural resources are characterized by each sales order contract and how they are identified and tracked from seller to buyer. Scanners, traditional RFPs, and parceled packaging do not exist in this world so standards in how they are handled, stored, distributed, and transported are unique to the industry including type of commodity.

Raw materials, natural resources, agricultural products, industrial parts, and machinery fall under the category of dry bulk or break-bulk products under the seller-buyer sales order contract. Dry bulk and break-bulk are different in that dry bulk are loose products. Break-bulk can be unitized, bundled or palletized and is known as general cargo. Dry bulk and break-bulk are also different in how items are labelled or rather identified from point of origin to point of destination.

Each loose commodity (defined as products such as sulphur, copper, lithium, zinc, coal, grain, wheat, wood chips, gas and oil including petrochemical products) is sold based on a purchase order number, grade, tonnage, and quality. Those characteristics determine how the product is identified for the physical mode of transportation, terminal location, facility location, and transportation ID number. It is the nature of the commodity that determines how it is carried across the water or land using the following modes of transportation; pipelines, commercial vehicles, railways, barges, marine vessels, ISO containers, Floating Production Storage Ocean Vessels (FPSO's).

Whether it be over land or over ocean, the lot number, purchase order number, grade, and destination remain constant unless the commodity is sold as a 'spot' trade shipment while enroute and a new purchase order contract number is created including a new notify party. Grade can change if wrong deliveries are made in the transit stage where pricing discounts are made, and breach of contracts are prevented, but the original trade contract identifier stays the same regardless of who buys this in the end. (Any re-routing of commodity in tracking to a new route would change the identifier of the transport vehicle such as the booking number, vessel number, trade number, name, or railcar number, locomotive number, or tanker truck number.)

Each commodity will use different interconnecting points of communication per mode of transport in terms of booking number, per vessel, trucking tank number, railcar number all correlated to the trade shipment number, voyage number, locomotive number, truck serial number, pipeline routing number, tank number and terminal lot/bin/silo number.

Since these items are loose non-unitized or packaged, a label of any sort is not a means to locate the shipment, rather they are identified by a specific lot number, grade, supplier name, and destination. If wrong deliveries are made after the trade shipment has reached its port or storage facility on land, then the buyer can refuse or accept a discount and take the commodity. If the buyer refuses, then the purchase order number is changed adding a new one, where rerouting would only change a portion of the lot # not necessarily the whole shipment or all the items.

Currently, there is no single model that fits the human and technical functionalities of the bulk process, rather various processes and multiple systems of reporting and tracking that work best in terms of capacity, capabilities of the software and technical procedures are in use.

A standardized model based on real-world use cases, structure and modes of transportation and identifiers attached to each commodity, all based on current industry use, language and operational procedures, is still needed. Communications between parties at each point of exchange of the commodity, equipment and material are key to understanding the bulk process.

To track any one product under an identifier or label requires a different method of tracking the product from seller to buyer to close the ID disconnects¹⁷¹ in many bulk transport scenarios.

Types of goods typically carried in:

- **Dry Bulk** - Wood Chips, Sulphur, Coal, Copper Concentrate, Nickel, Lithium, Zinc, Wheat, Grains, Ammonia, Aluminum, Fertilizers, Potash, and Pulse Products (e.g., Chickpeas, Green and Orange Lentils, Split Peas, Yellow Peas, Green Peas, Soya Beans).
- **Break-bulk** - Windmill towers, solar panels, yachts, machinery, boilers, mining equipment, heavy industrial equipment in general, industrial parts, lumber, wood pulp, newsprint, reels of paper, steel products, project cargo, containers on deck.

Dry Bulk Characteristics (related to identification):

- Goods are typically transported as “Loose Cargo”. The goods are often exposed to environmental conditions such as dust-like textures and are weather sensitive; Goods are generally not packaged for transport except in bags for grain products and fertilizers. Even when these products are packaged for transportation, these transport units are generally not identified uniquely.
- Mixing of wheat blends at terminal refinery determines allocation of product to buyer from seller are based on inventory levels. The sales order contract (trade transaction) between Seller and Buyer must include unambiguous identification of the specific batch/blend that is covered in the sales order contract.
- Port and terminal operations are usually conducted under conveyor belt systems (or other continuous transport means) sourcing from silos or railcar drop-off in areas per grade of product. For these products, the grade must be identified unambiguously also (next to an identifier generic for the product across grades).
- Wood chips follow same system of labelling at point of production, delivery to port, warehouse storage, while each allocation is supported under a lot number at warehouse and floor number.
- Copper concentrate identified under sales order, grade, destination that is transported “not bagged” is often sold while in a warehouse or prior to port storage facility.
- Product stock at the terminal elevator may be reallocated from one client/buyer to the other to meet delivery times. The sales order contract (ID) between Seller and Buyer continues to exist. The product identifiers (e.g., blend, lot and other identifiers) related to the trade transaction change prior to the picking, packing and despatch of those products on the first consignment related to the sales order contract.
- Bulk products may also become part of a sales order contract (Seller/Buyer) whilst they are in transit on some transport means (most commonly an ocean-going vessel). We may still use/create the sales order contract ID (as for orders described in more detail in Appendix 5). Seller and Buyer may be identified in exactly the same way as for the sales order contract

¹⁷¹ The ID gaps are the focus for this BRS and in this Appendix we will focus on that also.

described in Appendix 5). Trade item identification will follow the practice described in the bullets above. Destination location identification will generally be handled the same as for sales order contracts covered in Appendix 5). Because in this scenario the goods are in cargo hold(s) in the vessel, the identifiers used for the origin location will generally be different from those used for trade transaction covered in Appendix 5.

Dry bulk products are often handled in proximity to deep-sea ports due to the very large tonnages per grade and quality of the product. These large quantities require large capacity of terminals and refineries, vessel berth size appropriate for the often very large-scale vessels involved (for example, capesize, handymax, panamax, supermax) as well as large, specialized handling equipment. Vessels and equipment identifiers are needed for various purposes (including tracking and tracing).

When the goods are transported on vessels, multiple sellers and buyers are linked to the vessel consignments. There may be several vessel consignments transported per vessel hatch and hold area, generally a maximum of five to seven, dependent on class, size and make of ship.

In the text and bullets above, we referred to several different kinds of locations related to transport and/or storage of the products as they move between Seller and Buyer. To always “know where goods are” stakeholders need to unambiguously identify these locations.

Loose bulk operations generally make use of railway turnabouts and conveyor belt systems.

Charting the flow of Goods Under a Dry Bulk System

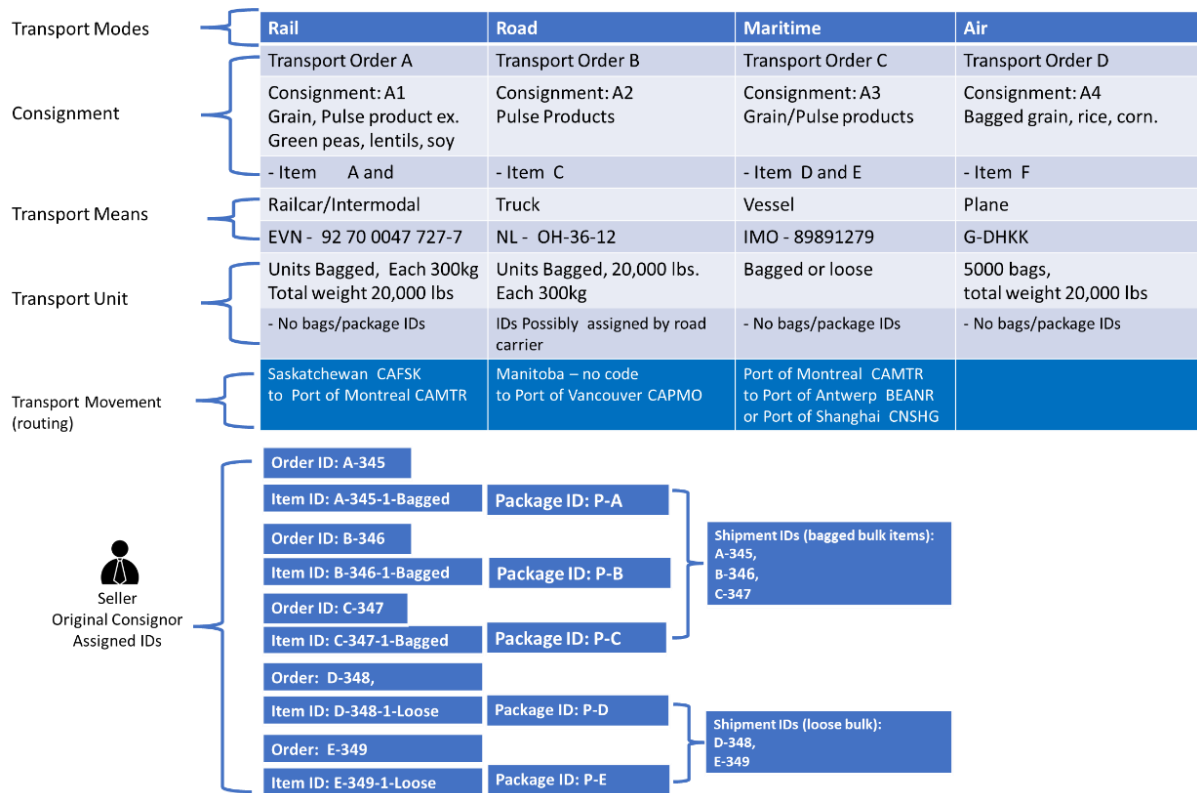

Figure 34. Bulk Transport Flow of Goods for Dry Bulk

Figure 34 above indicates identifiers (and their names) that are commonly used in dry bulk goods flows. The Order ID# equates to the trade transaction ID or trade shipment ID in UN/CEFACT terms. Item ID relates to the trade item ID; Package ID relates to the transport unit ID.

In bulk transportation, tracking of transport means to know where goods are is still a common practice. Transport means IDs are therefore also often exchanged among stakeholders between Seller and Buyer. The table also makes clear that in many stages of the life cycle of a bulk trade shipment (goods identified in the sales order contract), there are no identifiers available for the transport units (even if the goods are packaged). Package IDs are mentioned only for the road mode of transport.

Figure 34 also mentions the Transport Service Contract IDs. The example for Air is a flight-number. These Transport Service Contract identifiers may be used when track and trace information is not (generally) provided at the level of the transport means executing the service identified with the Transport Service Contract ID#.

Break-bulk Characteristics (related to identification):

- Goods are generally transported in transport units (Unitized) e.g., in bundles, crates, boxes, pallets, as stencils or wrapped units that are tagged and marked with transport unit IDs.
- Due to dimensions and weight, break-bulk products generally require forklifts, mobile and shore cranes, vessel self-loading systems in port and terminal storage, warehousing, and other goods handling spaces/locations as well as rail links, trucking lanes capable of handling these products. (Unique/Serialized) Trade Item IDs (and information associated

with the specific trade item) are essential to ensure that proper/appropriate handling of break-bulk products can be planned and executed.

In general, break-bulk consignments are consolidations of products for multiple end buyers, sold by multiple sellers and they may originate from different supply locations. So, they are shipped according to trade transactions between a buyer and a seller and then transported under a number of transport service contracts (consignments). A break-bulk trade shipment tends to be staged at a storage yard at its destination or project site/factory/warehouse.

The key identifiers are the original trade transaction (Purchase Order/Sales Order) IDs, the product identifiers (unique/serialized) and transport unit identifiers. One large piece of (heavy/industrial) equipment may be transported on many different transport units. For example, an ASML Lithography machine to make wafers of high-end electronic chips may require an entire cargo plane to transport all of the transport units related to the machine. The machine is then assembled at its destination location (in the buyer's facility).

The consignments associated with a trade shipment are sorted according to notify party, who may/may not be the end buyer. There is a need to link the consignment IDs with the goods identified in the sales order contract.

A cargo broker can act as a buyer. The broker may then hold on to the commodities or goods to sell later when they find the right buyer willing to pay the right price.

Note: Wood pulp and steel are usually further broken down for resale from the consignee warehouse or storage facility, still sold based on origin, grade, and price. This onward sale constitutes a new sales order contract (between a new buyer and new seller) within the context of this BRS. Even though new sales order contract IDs, transport unit IDs, consignment IDs will be created, in this scenario some of the identifiers related to the product covered in this new trade transaction will be the same identifiers as those used in the previous trade transaction. (This BRS will NOT elaborate further on this scenario.)

Machinery, project cargo, mining equipment, oil and gas equipment are sold and transported to a specific buyer. The buyer is clearly identified on the labels of the transport units consigned to a specific party and destination. In that sense, the relationship of the break-bulk trade shipments and consignments are very similar to the trade shipments covered in Appendix 4. Therefore, the same approaches described there may be used to devise and implement tracking and tracing solutions for break-bulk trade shipments and their consignments (flow of goods).

Figure 34 below indicates identifiers (and their names) that are commonly used in break-bulk goods flows. The Order ID# equates to sales order contract ID or trade shipment ID in UN/CEFACT terms. Item IDs related to the trade item identifiers. The Package IDs relate to the transport unit IDs.

Charting the flow of goods under a break-bulk system

Transport Modes	Rail	Road	Maritime	Air
Consignment	Transport Order A Consignment: A1 Steel Rebar/Wood pulp 4,6,8 bales	Transport Order B Consignment: A2 Colls, Lumber	Transport Order C Consignment: A3 Machinery, Industrial parts, Windmill towers, Blades	Transport Order D Consignment: A4 M Auto parts.
Transport Means	Item A and B Railcar/Intermodal Carrier ID: TRX12345	Item C and D Truck flatbed, super B Carrier ID: TRLU4567	Item E and F Vessel break bulk, barger IMO193678 and ID barge by federal state reg. no.	Item G Plane KL-8923
Transport Package	Bundled, wrapped, unitized, palletized, stacked Box car or intermodal ID: UP 35 49 69	Crates, 40ft Dry Van, Open top, 40ft Container, intermodal CSQU3053282	Vessel Hatch /Container on deck/ Deck space secured wrapped Vessel, Barge, Forklift, Railway, Vessel Crane, Shore Mobile Crane	ULD: AKH1234GW ULD: AKH2345GW
Transport Movement (routing)	Units/Bundled, Wrapped, Slinged Germany to Long Beach LA / Vancouver / Japan	Packages, Units, stacked, Korea to Houston, Savanah / Rotterdam	Gantry Crane, Mobile Crane, Vessel Crane Brazil to Seattle, WA. Germany, Washington USA / Turkey / Vancouver	Labelled per serial no. per factory, package, crate or box. Frankfurt / Vancouver Airport



Figure 35. Bulk Transport Flow of Goods for Break-Bulk

The Delivery to the Buyer (see the box in Figure 34 with the **Shipment IDs**) consists of seven trade shipments, each of which may have been sent by a different seller. This is a common scenario in oil and gas when supplies must be delivered to offshore rigs. This kind of consolidation for delivery can easily be mapped using the approaches described in Appendix 4.

Both figures (covering dry-bulk and break-bulk) clearly demonstrate the difference between the flow of goods and how labelling is very different between the two types of goods when moving the different product types from sellers to buyers. They have to use different identifiers when carried on multi-modal and intermodal means due to the product characteristics.

An important distinction to make from both charts is the ID disconnects that exist when product is moved from one mode of transportation to the other or when product may be handled/consolidated in a warehouse. Break-bulk trade shipments consisting of labelled items/transport units (containing for example lumber, wood pulp, steel products and industrial parts) that are stenciled and tagged, labeled or marked are easier to accurately identify compared to dry-bulk products.

On the other hand, there are generally large numbers of break-bulk trade shipments on a single transport means (e.g., a vessel) compared to a ship carrying dry-bulk product for fewer sellers or outright chartered by one seller. As indicated above, this seller may sell the product to prospective buyers whilst the vessel is sailing towards its destination ports to then offload products related to the sales order contracts concluded underway in those destination ports.

Grains, similar to lumber can be moved via container instead of using dry-bulk transportation if it is bagged or unitized. In that case, the transport unit using break-bulk transportation may have a unique and unambiguous identifier available on a clear label or tag (see also Appendix 5 for tracking technologies) versus products that are not tagged in the dry-bulk context.

Currently, industry stakeholders involved in the transportation of products, that may be transported as bagged items (e.g., fertilizer, wood chips, lumber, wood pulp) combined with loose items or in container movements, prefer not to bag the product using break-bulk transport approaches. There are several reasons as to why they still prefer to use the dry-bulk approaches (despite the challenges with lack of track and trace, type of product and associated stock management issues). The primary reasons have to do with

- Cost per unit of product transported
- Time needed to bag the product at origin (the seller's facility).
- Less tonnage shipped on a specific transport means (e.g., vessel).
- Higher handling costs whilst in transit (it takes more time and effort to handle the separate bags).