

3 March 2023

Agreement

Concerning the Adoption of Harmonized Technical United Nations Regulations for Wheeled Vehicles, Equipment and Parts which can be Fitted and/or be Used on Wheeled Vehicles and the Conditions for Reciprocal Recognition of Approvals Granted on the Basis of these United Nations Regulations*

(Revision 3, including the amendments which entered into force on 14 September 2017)

Addendum 147 – UN Regulation No. 148

Amendment 5

01 series of amendments – Date of entry into force: 4 January 2023

Uniform provisions concerning the approval of light-signalling devices (lamps) for power-driven vehicles and their trailers

This document is meant purely as documentation tool. The authentic and legal binding text is: ECE/TRANS/WP.29/2022/92 (as amended by paragraph 142 of the report ECE/TRANS/WP.29/1166).



UNITED NATIONS

* Former titles of the Agreement:

Agreement concerning the Adoption of Uniform Conditions of Approval and Reciprocal Recognition of Approval for Motor Vehicle Equipment and Parts, done at Geneva on 20 March 1958 (original version); Agreement concerning the Adoption of Uniform Technical Prescriptions for Wheeled Vehicles, Equipment and Parts which can be Fitted and/or be Used on Wheeled Vehicles and the Conditions for Reciprocal Recognition of Approvals Granted on the Basis of these Prescriptions, done at Geneva on 5 October 1995 (Revision 2).



UN Regulation No. 148, amend to read:

"UN Regulation on uniform provisions concerning the approval of light-signalling devices (lamps) for power-driven vehicles and their trailers

Contents

Page

Regulation

1. Scope	3
2. Definitions.....	3
3. Administrative provisions	4
4. General technical requirements	12
5. Specific technical requirements.....	19
6. Conformity of production.....	28
7. Transitional provisions.....	29

Annexes

1 Communication	31
2 Angles of geometric visibility	34
3 Standard light distributions	39
4 Minimum requirements for conformity of production control procedures.....	47
5 Minimum requirements for sampling by an inspector.....	49
6 Heat resistance test for rear fog lamps and daytime running lamps	51
7 Arrangement of approval markings.....	52
8 Testing procedures with respect to light sources.....	55

Introduction (for information)

This Regulation combines the provisions of individual UN Regulations Nos. 4, 6, 7, 23, 38, 50, 77, 87 and 91 into a single Regulation, and is the outcome of the World Forum for Harmonization of Vehicle Regulations (WP.29) decision to simplify the lighting and light-signalling Regulations based on the initial proposal by the European Union and Japan.

The objective of this Regulation is to increase the clarity, to consolidate and streamline the complexity of requirements in UN Regulations Nos. 4, 6, 7, 23, 38, 50, 77, 87 and 91 and to prepare for the transition to performance-based requirements, by reducing the number of Regulations through an editorial exercise without changing any of the detailed technical requirements already in force up to the date of entry into force of this Regulation. This is reflected by the introduction of the original series of amendments to UN Regulation No. 148 and completes one of the objectives of the Working Party on Light and Light-Signalling (GRE) Informal Working Group “Simplification of Lighting and Light-Signalling Regulations” (IWG SLR).

With the introduction of the 01 series of amendments to this Regulation another objective of GRE IWG SLR comes into existence. This new series of amendments deals with the identified amendments and clarifications to this Regulation in order to achieve, to the current maximum possible extent, the goal of being technologically neutral, performance based and able to be tested objectively. This is accompanied by amendments to UN Regulations regarding the installation of lighting and light-signalling devices (Nos. 48, 53, 74 and 86) to reflect any necessary changes influenced by this Regulation.

1. Scope

This Regulation applies to the following light-signalling devices (lamps):

- Rear-registration plate illuminating lamps
- Direction indicator lamps
- Position lamps
- Stop lamps
- End-outline marker lamps
- Reversing lamps
- Manoeuvring lamps
- Rear fog lamps
- Parking lamps
- Daytime running lamps
- Side marker lamps

2. Definitions

For the purposes of this Regulation:

- 2.1. All the definitions given in the latest series of amendments to UN Regulation No. 48 in force at the time of application for type approval shall apply, unless otherwise specified in this Regulation or in the pertinent installation UN Regulations Nos. 53, 74 and 86.
- 2.2. *"Lamps of different types"* means lamps, which differ in such essential respects as:
 - (a) The trade name or mark:
 - (i) Lamps bearing the same trade name or mark but produced by different manufacturers are considered as being of different types;

- (ii) Lamps produced by the same manufacturer differing only by the trade name or mark are considered as being of the same type.
- (b) The characteristics of the optical system (levels of intensity, light distribution angles, inclusion or elimination of components capable of altering the optical effects by reflection, refraction, absorption and/ or deformation during operation, etc.);
- (c) The category or categories of light source(s) used and/or the specific identification code (s) of the light source module(s);
- (d) The category of the lamp, if any;
- (e) The variable intensity control, if any;
- (f) The sequential activation of light sources, if any.

Nevertheless, direction indicators capable of being activated in different modes (sequential or not) without any modification of the optical characteristics of the lamp do not constitute "*Direction indicators of different types*".

A change of the colour of the light source or the colour of any filter does not constitute a change of type.

The use of LED substitute light source(s) does not constitute a change of type. However, paragraph 4.8.1.6. applies.

- 2.3. "*Being part of the lamp*" means to be physically included in the lamp body or to be external, separated or not, and declared by the applicant as part of the lamp system.

3. Administrative provisions

- 3.1. Application for approval
 - 3.1.1. The application for type approval shall be submitted by the holder of the trade name or mark or by his duly accredited representative.
 - 3.1.2. It shall be accompanied by:
 - 3.1.2.1. drawings, sufficiently detailed to permit identification of the type and, if applicable, of the category of the lamp, showing:
 - (a) Geometrically in what position(s) the lamp (and if applicable the rear window) may be mounted on the vehicle;
 - (b) The axis of observation to be taken as the axis of reference in the tests (horizontal angle $H = 0^\circ$, vertical angle $V = 0^\circ$); and the point to be taken as the centre of reference during the tests;
 - (c) The limit of the apparent surface of the function(s);
 - (d) The space reserved and the arrangement intended for the approval marking or the "Unique Identifier";
 - (e) In case of replaceable source module(s), the module(s) and the space reserved for the specific identification code(s) of the module(s) on the lamp and on the module(s);
 - (f) In the case of an interdependent lamp system, the interdependent lamp or the combination of interdependent lamps that fulfil the relevant requirements.
 - (g) In the case of a lamp that may incorporate a vehicle manufacturer logo, the vehicle manufacturer logo.

- 3.1.2.2. A brief technical description stating in particular
- (a) In case of lamps with replaceable UN approved light sources, the category or categories of light source(s) prescribed;
 - (b) In case of lamps with replaceable light source module(s), the light source module specific identification code;
 - (c) The make and type of electronic light source control gear(s) or variable intensity control(s) if any, and if not being part of the lamp.
 - (d) In the case the lamp shall also be approved with LED substitute light source(s) according to UN Regulation No. 128, the category or categories of light sources(s) prescribed;
 - (e) In the case a device is intended to be mounted inside the vehicle, the technical description shall contain the specification of the optical properties (transmission, colour, inclination, etc.) of the rear window(s).
 - (f) In the case of a lamp that may incorporate a vehicle manufacturer logo, the applicant shall confirm by a statement provided by the vehicle manufacturer that the vehicle manufacturer logo is the official appropriate one related to the brand name of the vehicle manufacturer or body manufacturer.
- 3.1.2.3. However, in the case of a type of lamp differing only by the trade name or mark from a type that has already been approved it is sufficient that the application is accompanied by:
- 3.1.2.3.1. A declaration by the lamp manufacturer that the type submitted is identical (except in the trade name or mark) with and has been produced by the same manufacturer as the type already approved, the latter being identified by its approval number;
 - 3.1.2.3.2. Two samples bearing the new trade name or mark or equivalent documentation.
- 3.1.2.4. In the case of a lamp with variable intensity, a concise description of the variable intensity control, an arrangement diagram and a specification of the characteristics of the system covering the entire range of intensity;
- 3.1.2.5. In the case of lamps equipped with non-replaceable filament light source(s) or light source module(s) equipped with non-replaceable filament light source(s), a report, acceptable to the Authority responsible for type approval, that demonstrates compliance of these non-replaceable filament light source(s) with the requirements as specified in paragraph 4.11 of IEC 60809, Edition 4.
- 3.1.2.6. At the discretion of the applicant, the description may specify if the lamp may be installed on the vehicle with different inclinations of the reference axis in respect to the vehicle reference planes and to the ground, or rotate around its reference axis; these different conditions of installation shall be indicated in the communication form.
- 3.1.2.7. If not otherwise specified for the relevant lamp, the following samples:
- (a) Two complete samples of the lamp.
If application is made for the approval of lamps which are not identical but are symmetrical and suitable for mounting one on the left and one on the right side of the vehicle, the two samples submitted may be identical and be suitable for mounting only on the right or only on the left side of the vehicle;
 - (b) For a variable-intensity lamp, a sample of the variable intensity control or a generator providing the same signal(s).

- 3.1.2.8. In the case of a lamp which is intended to be mounted inside the vehicle, a sample plate or sample plates (in case of different possibilities) having the equivalent optical properties corresponding to those of the actual rear window(s).
- 3.2. Approval
- 3.2.1. A separate approval is required for each lamp listed in paragraph 1.
- 3.2.2. When two or more lamps are part of the same unit of grouped, combined or reciprocally incorporated lamps, approval may be granted only if each of these lamps satisfy the provisions set out in this Regulation or in another Regulation. Lamps not satisfying the provisions of any of those Regulations shall not be part of such unit of grouped, combined or reciprocally incorporated lamps.
- 3.2.3. If the type of lamp(s) submitted for approval in pursuance of paragraph 3.1. meets the requirements of this Regulation, approval shall be granted. All the devices of an interdependent lamp system must be submitted for type approval by the same applicant.
- 3.2.3.1. Notice of approval or of extension or refusal or withdrawal of approval or production definitely discontinued of a type of a lamp pursuant to this Regulation shall be communicated to the Contracting Parties to the 1958 Agreement which apply this Regulation, by means of a form conforming to the model in Annex 1;
- 3.2.3.2. An approval number shall be assigned to each type of lamp approved and shall be indicated for each lamp in the communication form in Annex 1.
A contracting party may assign the same approval number to light-signalling devices or systems incorporating a number of lamps but shall not assign the same number to another type of lamp of the same function.
- 3.2.4. The symbols identifying the light signalling lamp (function) for which type approval has been granted.

Table 1

List of symbols

<i>Lamp (function)</i>	<i>Symbol</i>	<i>Paragraph</i>
Daytime running lamp	RL	5.4.
Front direction indicator lamp	1, 1a, 1b, 11, 11a, 11b, 11c	5.6.
Front end-outline marker lamp	AM	5.1.
Front position lamp for category L vehicle	MA	5.1.
Front position lamp	A	5.1.
Manoeuvring lamp	ML	5.10.
Parking lamp (Forward and rearward facing)	77R	5.3.
Rear direction indicator lamp (steady)	2a	5.6.
Rear direction indicator lamp (variable)	2b	5.6.
Rear direction indicator lamp for category L vehicle	12	5.6.
Rear end-outline marker lamp (steady)	RM1	5.2.
Rear end-outline marker lamp (variable)	RM2	5.2.
Rear fog lamp (steady)	F1	5.9.
Rear fog lamp (variable)	F2	5.9.

<i>Lamp (function)</i>	<i>Symbol</i>	<i>Paragraph</i>
Rear position lamp for category L vehicle	MR	5.2.
Rear position lamp (steady)	R1	5.2.
Rear position lamp (variable)	R2	5.2.
Rear-registration plate illuminating lamp	L	5.11.
Rear-registration plate illuminating lamp for category L vehicle	LM1	5.11.
Reversing lamp (note: the letters A and R may be mingled)	AR	5.8.
Side direction indicator lamp	5, 6	5.6.
Side marker lamp for all vehicle categories	SM1	5.7.
Side marker lamp for M ₁ vehicles	SM2	5.7.
Stop lamp (central high mounted) (steady)	S3	5.5.
Stop lamp (central high mounted) (variable)	S4	5.5.
Stop lamp for category L vehicle	MS	5.5.
Stop lamp (steady)	S1	5.5.
Stop lamp (variable)	S2	5.5.

- 3.2.5. The applicable change indexes for each device relating to the series of amendments shall be as follows (see also paragraph 7.1.1.):

Table 2

Series of amendments and change index

<i>Series of amendments to the Regulation</i>	<i>00</i>	<i>01</i>	
<i>Lamp (function)</i>	<i>Change Index for the specific Lamp (function)</i>		
Daytime running lamp	0	1	
Front direction indicator lamp	0	1	
Front direction indicator lamp (Vehicle category L)	0	1	
Front end-outline marker lamp	0	1	
Front position lamp	0	1	
Front position lamp (Vehicle category L)	0	1	
Manoeuvring lamp	0	1	
Parking lamp	0	1	
Rear direction indicator lamp	0	1	
Rear direction indicator lamp (Vehicle category L)	0	1	
Rear end-outline marker lamp	0	1	
Rear fog lamp	0	1	

<i>Series of amendments to the Regulation</i>	<i>00</i>	<i>01</i>	
<i>Lamp (function)</i>	<i>Change Index for the specific Lamp (function)</i>		
Rear position lamp	0	1	
Rear position lamp (Vehicle category L)	0	1	
Rear-registration plate illuminating lamp	0	1	
Rear-registration plate illuminating lamp (Vehicle category L)	0	1	
Reversing lamp	0	1	
Side direction indicator lamp	0	1	
Side marker lamp	0	1	
Stop lamp	0	1	
Stop lamp (Vehicle category L)	0	1	
Stop lamp (central high mounted)	0	1	

Notes to Table 2:

A dash “-” means that this lamp (function) is not available for type approvals according to the corresponding series of amendments.

- 3.3. Approval marking and other markings
- 3.3.1. General provisions
- 3.3.1.1. Every device belonging to an approved type shall comprise a space of sufficient size for the Unique Identifier as referred to in the 1958 Agreement and other markings as defined in paragraphs 3.3.4.2. to 3.3.4.6. or the approval marking and other markings as defined in paragraphs 3.3.4.2. to 3.3.4.6.
- 3.3.1.2. All markings shall be clearly legible and indelible,
- 3.3.1.3. With regard to the size of the approval marking the value for “a” in part 1 of Annex 7 shall be at least 5 mm.
- Examples of the arrangement of the markings are shown in Annex 7.
- 3.3.2. The approval marking shall consist of:
- 3.3.2.1. The approval mark, i.e. a circle surrounding the letter "E" followed by the distinguishing number of the country which has granted approval.
- 3.3.2.2. The four to six-digit sequential number, being part of the approval number prescribed in paragraph 3.2.3.2. This sequential number shall be placed close to the approval mark.
- 3.3.2.3. The symbols identifying the light signalling lamps prescribed in paragraph 3.2.4.
- 3.3.2.4. The number of this Regulation followed by the letter 'R' and the two digits indicating the series of amendments in force at the time of issue of the approval.
- 3.3.2.5. The following additional symbol(s), if applicable:
- 3.3.2.5.1. On lamps which cannot be mounted on either side of the vehicle indiscriminately, a horizontal arrow showing in which position the lamp is to be mounted.

- 3.3.2.5.1.1. The arrow shall be directed outwards from the vehicle in the case of:
- Direction indicators categories 1, 1a, 1b, 2a, 2b, 11, 11a, 11b, 11c and 12;
 - Front or rear position lamps, front or rear end-outline marker lamps;
 - Reversing lamps in case of reduced light distribution of two reversing lamps.
- 3.3.2.5.1.2. The arrow shall be directed towards the front of the vehicle in the case of direction indicators of categories 5 and 6 and combined parking lamps
- 3.3.2.5.1.3. For direction indicators of category 6 an indication "R" or "L" shall be shown on the lamp, indicating the right or left side of the vehicle.
- 3.3.2.5.2. If applicable, to the right side of the symbol mentioned in paragraph 3.2.4.:
- The additional letter "D", on lamps which may be used as part of an assembly of two independent lamps;
 - The additional letter "Y", on lamps which are used as part of an interdependent lamps system.
- 3.3.2.5.3. On lamps with reduced light distribution, see paragraph 1.1. of Annex 3, a vertical arrow starting from a horizontal segment and directed downwards.
- 3.3.3. Unique Identifier (UI)
- 3.3.3.1. The approval marking as defined in paragraph 3.3.2. may be replaced by the Unique Identifier, if available. The Unique Identifier mark shall follow the format in the example shown below:

Figure I

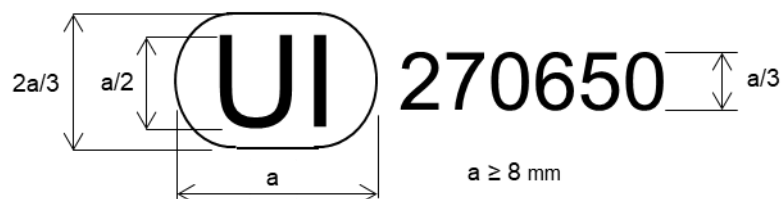
Unique Identifier (UI)

The above Unique Identifier marked on the lamp shows that the type concerned has been approved and that the relevant information on that type approval can be accessed on the UN secure internet database by using 270650 as the Unique Identifier.

- 3.3.4. Marking requirements
- 3.3.4.1. Lamps shall bear the approval marking or the Unique Identifier.
- 3.3.4.2. Lamps shall bear the trade name or mark of the applicant
- 3.3.4.3. Lamps shall, with the exception of lamps with non-replaceable light sources, bear a marking indicating:
- The category or categories of light source(s) prescribed;
 - in the case where the lamp has been approved for LED substitute light source(s), also the category or categories of the LED substitute light source(s);
- 3.3.4.4. Lamps shall bear marking of the rated voltage(s) (i.e. 6V, 12V or 24V) or the range of voltage, in the case of lamps with:
- An electronic light source control gear; and/or

- (b) A variable luminous intensity control; and/or
 - (c) A secondary operating mode; and/or
 - (d) Non-replaceable light sources; and/or
- 3.3.4.5. In case replaceable light source module(s) is/are used, bear the following markings.
- (a) On the light source module(s):
 - (i) The trade name or mark of the applicant;
 - (ii) The specific identification code of the module; This specific identification code shall comprise the starting letters “MD” for “MODULE” followed by the approval mark without the circle as prescribed in paragraph 3.3.2.1.1. or by the Unique Identifier without the truncated circle as prescribed in paragraph 3.3.3. In case several non-identical light source modules are used, followed by additional symbols or characters; The approval mark or the Unique Identifier does not have to be the same as the one on the lamp in which the module is used, but both marks shall be from the same applicant;
 - (iii) The rated voltage(s) or the range of voltage.
 - (b) On the lamp:
 - (i) The specific identification code of the module as prescribed in paragraph 3.3.4.5. (a), (ii);
 - (ii) The rated voltage(s) or the range of voltage.
- 3.3.4.6. In case an electronic light source control gear or variable luminous intensity control being part of the lamp, but not included into the lamp body, the lamp shall bear its identification number and the name of the manufacturer.
- 3.3.5. Marking location
- 3.3.5.1. The approval marking or the Unique Identifier shall be placed on an inner or outer part (transparent or not) of the lamp which is not designed to be separated from the transparent part of the lamp emitting the light.
- 3.3.5.2. In any case the approval marking or the Unique Identifier as well as the category or categories of LED substitute light source(s) prescribed, if any, shall be visible when the lamp is fitted on the vehicle or when a movable part such as the hood or boot lid or a door is opened.
- 3.3.5.3. If the outer lens of a device is designed to be separated from the main body, the Unique Identifier or the approval marking shall be placed on both, the detachable lens and the main body.
- 3.3.5.4. In case an outer lens is used for several devices and bearing different approval markings, the main body of each device shall bear only the approval marking of the function(s) of that device.
- 3.3.5.5. The approval marking or the Unique Identifier and the markings in paragraphs 3.3.4.2., 3.3.4.3., 3.3.4.4., 3.3.4.5. (b) and 3.3.4.6. shall be affixed on the lamp.
- 3.3.5.6. The markings in paragraphs 3.3.4.5.(a) shall be affixed on the component.
- 3.3.5.7. The markings in paragraphs 3.3.4.2., 3.3.4.3. (a), 3.3.4.4., 3.3.4.5. and 3.3.4.6. do not need to fulfil the requirements of paragraph 3.3.5.2.
- 3.3.6. Grouped, combined or reciprocally incorporated lamps
- 3.3.6.1. Where grouped, combined or reciprocally incorporated lamps have been found to comply with the requirements of several UN Regulations, a single approval mark with the four to six-digit sequential number or Unique Identifier may be

affixed. This marking may be located anywhere on the grouped, combined or reciprocally incorporated lamps, provided that:

- 3.3.6.1.1. It is visible after their installation;
- 3.3.6.1.2. No part of the grouped, combined or reciprocally incorporated lamps that transmits light can be removed without at the same time removing the approval mark.
- 3.3.6.2. The size of the components of a single approval mark shall not be less than the minimum size required for the smallest of the individual marks by the pertinent UN Regulations under which approval has been granted.
- 3.3.6.3. Annex 7 gives examples of approval marking arrangements for grouped, combined or reciprocally incorporated lamps with all the additional symbols mentioned above.
- 3.4. Modifications of a type of lamp for motor vehicles and their trailers and extension of approval
 - 3.4.1. Every modification of a type of lamp shall be notified to the Type Approval Authority which approved the type. The Authority may then either:
 - 3.4.1.1. Consider that the modifications made are unlikely to have an appreciable adverse effect and that in any case the lamp still complies with the requirements; or
 - 3.4.1.2. Require a further test report from the technical service responsible for conducting the tests.
 - 3.4.2. Confirmation or refusal of approval, specifying the alterations, shall be communicated by the procedure specified in paragraph 3.2.3.1. to the Contracting Parties to the 1958 Agreement applying this Regulation.
 - 3.4.3. The Type Approval Authority issuing the extension of approval shall assign a series number for such an extension and inform thereof the other Contracting Parties to the 1958 Agreement applying the UN Regulation under which the approval has been granted by means of a communication form conforming to the model in Annex 1.
- 3.5. Conformity of production procedures

The conformity of production procedures shall comply with those set out in the 1958 Agreement, Schedule 1 (E/ECE/TRANS/505/Rev.3), with the requirements set forth in paragraph 6.
- 3.6. Penalties for non-conformity of production
 - 3.6.1. The approval granted may be withdrawn if the requirements in this Regulation are not met;
 - 3.6.2. If a Contracting Party to the 1958 Agreement which applies this Regulation withdraws an approval it has previously granted, it shall forthwith so notify the other Contracting Parties applying this Regulation, by means of a communication form conforming to the model in Annex 1.
- 3.7. Production definitively discontinued

If the holder of the approval completely ceases to manufacture a lamp approved in accordance with this Regulation, he shall so inform the authority which granted the approval. Upon receiving the relevant communication, that authority shall inform thereof the other Contracting Parties to the 1958 Agreement applying this Regulation by means of a communication form conforming to the model in Annex 1.
- 3.8. Names and addresses of Technical Services responsible for conducting approval tests, and of Type Approval Authorities

The Contracting Parties to the 1958 Agreement which apply the Regulation shall communicate to the United Nations Secretariat the names and addresses of the Technical Services responsible for conducting approval tests and of the Type Approval Authorities which grant approval and to which forms certifying approval or extension or refusal or withdrawal of approval, or the definitive discontinuation of production issued in other countries, are to be sent.

- 3.9. Remarks concerning colours and particular devices in the case of end-outline marker lamps and parking lamps

The Contracting Parties to the 1958 Agreement to which this Regulation is annexed are not precluded by Article 3 of that Agreement from prohibiting, for lamps installed on vehicles registered by them, certain colours for which provision is made in this Regulation, or from prohibiting for all categories or for certain categories of vehicles registered by them stop lamps having only steady luminous intensity.

4. General technical requirements

- 4.1. Each lamp submitted for approval shall conform to the requirements set forth in paragraphs 4. and 5.

- 4.2. The requirements contained in sections 5 "General specifications" and 6 "Individual specifications" (and in the Annexes referenced in the said sections) of UN Regulations Nos. 48, 53, 74 or 86, and their series of amendments in force at the time of application for the lamp type approval shall apply to this Regulation.

The requirements pertinent to each lamp and to the category/ies of vehicle on which the lamp is intended to be installed shall be applied, where its verification at the moment of lamp type approval is feasible.

- 4.3. The lamps must be so designed and constructed that in normal conditions of use, and notwithstanding the vibrations to which they may be subjected in such use, their satisfactory operation remains assured and they retain the characteristics prescribed by this Regulation.

- 4.4. Independent and interdependent lamps

- 4.4.1. An assembly of two independent lamps to be type approved as lamp marked "D" is applicable to front and rear position lamps, stop lamps, front and rear end-outline marker lamps, daytime running lamps and direction indicator lamps;

- 4.4.2. An interdependent lamp system to be type approved as lamps marked "Y" is applicable to front and rear position lamps, stop lamps, front and rear end-outline marker lamps, daytime running lamps and direction indicator lamps.

- 4.5. Lamps as such or grouped, combined, reciprocally incorporated

- 4.5.1. Lamps having been approved as front or rear position lamps, are deemed being also approved end-outline marker lamps.

- 4.5.2. Front and rear position lamps which are grouped or combined or reciprocally incorporated may also be used as end-outline marker lamps.

- 4.5.3. Position lamps or daytime running lamps, which are reciprocally incorporated with another function, using a common light source, and designed to operate permanently with an additional system to regulate the intensity of the light emitted, are permitted.

- 4.5.3.1. However, in the case of a rear position lamp reciprocally incorporated with a stop lamp, these functions shall either:

- (a) be provided by multiple light sources (for instance, a double filament light source); or

- (b) be intended for use in a vehicle equipped with a tell-tale indicating failure for the lamps.

In either case, a note shall be made within the communication document.

- 4.5.4. If a front position lamp incorporates one or more infrared radiation generators, the photometric and colour requirements for this front position lamp shall be met with and without the operation of the infrared radiation generator(s).

- 4.5.5. On request of the applicant, the internal structure of the optical components and/or the texture of the outer lens inside of the apparent surface of a lamp (function) may incorporate only one manufacturer logo build by transparent or non-transparent components provided that all requirements for the specific function of this Regulation are fulfilled and in addition the following conditions:

- (a) Irrespective of the marking requirements in paragraph 3.3., only the logo of the brand name of the vehicle manufacturer or the body manufacturer is allowed. This shall be confirmed by the applicant by a statement (see paragraph 3.1.2.2. (f)).
- (b) Size: the enclosed light emitting surface of the logo (incorporating transparent and non-transparent components of the logo) of such a lamp in the direction of the reference axis shall not exceed 100 cm².
- (c) Symmetry: notwithstanding the requirements of paragraph 5.5.2. of UN Regulation No. 48, the logo light emitting surface (incorporating transparent and non-transparent components of the logo) does not have to be symmetrical by itself.
- (d) Stop lamps, direction indicator lamps, and reversing lamps shall not incorporate a logo.

- 4.6. Failure provisions

- 4.6.1. Failure of a single lamp containing more than one light source

- 4.6.1.1. In a single lamp containing more than one light source, a group of light sources, wired so that the failure of any one of them causes all of them to stop emitting light, shall be considered to be one light source.

- 4.6.1.2. In case of failure of any one light source in a single lamp containing more than one light source, at least one of the following provisions shall apply:

- (a) The light intensity complies with the minimum intensity required in the pertinent table of standard light distribution as shown in Annex 3 and when all light sources are illuminated the maximum intensities shall not be exceeded; or
- (b) A signal for activation of a tell-tale indicating failure, as indicated in paragraphs 6.4.8., 6.7.8., 6.9.8, 6.10.8., 6.11.8., 6.12.8., 6.13.8. and 6.18.8. of UN Regulation No. 48, is produced. In this case a note in the communication form states that the lamp is only for use on a vehicle fitted with a tell-tale indicating failure.

- 4.6.1.3. For daytime running lamps, instead of the requirements of paragraph 4.6.1.2. and in addition to the requirements of paragraph 4.6.1.1., the following provisions apply:

In case of failure of any one light source in a single lamp containing more than one light source, at least one of the following provisions shall apply:

- (a) The light intensity at the points of standard light distribution defined in paragraph 2.2. of Annex 3 shall be at least 80 per cent of the minimum intensity required; or
- (b) A signal for activation of a tell-tale indicating failure, as indicated in paragraph 6.19.8. of UN Regulation No. 48, is produced. In this case a

note in the communication form states that the lamp is only for use on a vehicle fitted with a tell-tale indicating failure.

- 4.6.1.4. For direction-indicator lamps of categories 1, 1a, 1b, 2a, 2b, 11, 11a, 11b, 11c and 12, instead of the requirements of paragraph 4.6.1.2. and in addition to the requirements of paragraph 4.6.1.1., the following provisions apply:

A signal for activation of the tell-tale prescribed in paragraph 6.5.8. of Regulation No. 48 or paragraph 6.3.8. of Regulation No. 53 shall be produced on the basis of either option a), b) or c) (notwithstanding the provisions stated in paragraph 4.6.):

- (a) Any one light source has failed;
- (b) In the case of a lamp designed for only two light sources, the intensity in the axis of reference is less than 50 per cent of the minimum intensity required;
- (c) As a consequence of a failure of one or more light sources, the intensity in one of the following directions as indicated in paragraph 2.1. of Annex 3, is less than the minimum intensity required:
 - (i) $H=0^\circ$, $V=0^\circ$
 - (ii) $H=20^\circ$ outwards to the outside of the vehicle, $V=+5^\circ$
 - (iii) $H=10^\circ$ inwards to the inside of the vehicle, $V=0^\circ$.

- 4.6.1.5. The requirements of paragraph 4.6.1.2. do not apply to rear registration plate lamps. However, the requirements of paragraph 4.6.1.1. are still applicable.

- 4.6.1.6. The requirements of paragraph 4.6.1.2. (b) do not apply to stop- and position lamps for vehicles of category L. However, the requirements of paragraph 4.6.1.1. and paragraph 4.6.1.2. (a) are still applicable

- 4.6.2. In case of failure of the variable intensity control of:

- (a) A rear position lamp category R2 emitting more than the maximum value of category R1;
- (b) A rear end-outline marker lamp category RM2 emitting more than the maximum value of category RM1;
- (c) A stop lamp category S2 emitting more than the maximum value of category S1;
- (d) A stop lamp category S4 emitting more than the maximum value of category S3;
- (e) A direction indicator of category 2b emitting more than the maximum value of category 2a;
- (f) A rear fog lamp of category F2 emitting more than the maximum value of category F1.

Requirements of steady luminous intensity of the respective category shall be fulfilled automatically.

- 4.7. Provisions with regard to light sources

- 4.7.1. Use of light sources.

The lamp shall only be equipped with:

- replaceable light source(s) approved according to UN Regulations Nos. 37, 99 and/or 128, provided that no restriction on the use is made at the time of application for type approval, and/or
- light source module(s) and/or
- non-replaceable light source(s)

- 4.7.2. General requirements with regard to light sources
- 4.7.2.1. In case a light source category or categories or type(s) is restricted for use in lamps on vehicles in use and originally equipped with such lamps, the applicant for type approval of the lamp shall declare that the lamp is only intended for installation on those vehicles; this shall be noted in the communication form
- 4.7.2.2. In case of replaceable UN approved light source(s),
- (a) The design of the lamp shall be such that the light source(s) can be fixed in no other position but the correct one;
 - (b) The light source(s) holder shall conform to the characteristics given in IEC Publication 60061. The holder data sheet relevant to the category of light source(s) prescribed, applies. In addition, where a category of LED substitute light source(s) is also prescribed, the holder data sheet relevant to the category of LED substitute light source(s) applies.
- 4.7.2.3. Light Signalling Devices shall not generate radiated or power line disturbances, which cause a malfunction of other electric/electronic systems of the vehicle.¹
- 4.7.2.4. In case of replaceable light source module(s), the design of the light source module(s) shall be such that
- (a) it can only be fitted in the designated and correct position and can only be removed with the use of tool(s); and
 - (b) it is tamperproof; and
 - (c) regardless of the use of tool(s), it is not interchangeable with:
 - any replaceable UN approved light source; and/or,
 - any other replaceable light source module having different characteristics that is located in the same lamp housing.
 - (d) when the light source module is removed and replaced by another module provided by the applicant and bearing the same light source module identification code, the photometric requirements of device shall be met.
- 4.8. Test conditions and measurement methods
- 4.8.1. General provisions
- All measurements, photometric and colorimetric, shall be made with respect to the following conditions. (Particulars of the methods of measurement to be used are given in Annex 3):
- 4.8.1.1. In the case of replaceable UN approved light sources, all measurements shall be made using standard light sources as specified in R.E.5.
- 4.8.1.1.1. Additionally, in the case of replaceable UN approved light source(s) controlled by an electronic light source control gear or variable intensity control, the standard light source(s) shall have a luminous flux value that does not deviate more than 5 per cent from its reference/objective luminous flux value when test voltage is applied.
- 4.8.1.2. In the case of a lamp equipped with light source module(s) or non-replaceable light source(s), all measurements shall be made with the light source(s) present in the lamp.
- 4.8.1.3. In case of a lamp (function) using light sources which are subject to more than one of the conditions prescribed in paragraph 4.8., the photometric measurements shall be made separately, in accordance with each applicable condition(s) set forth in paragraph 4.8.

¹ Compliance with the requirements for electromagnetic compatibility is relevant to the vehicle type.

All separate measurement results shall be added together.

The test laboratory may require from the applicant samples allowing to supply the different light source(s) separately.

- 4.8.1.4. During photometric measurements, stray reflections shall be avoided by appropriate masking.
- 4.8.1.5. In the case where the lamp may be installed on the vehicle in more than one or in a field of different positions the photometric measurements shall be repeated for each position or for the extreme positions of the field of the reference axis specified by the manufacturer.
- 4.8.1.6. In the case where the lamp, at the discretion of the applicant, also has to be approved with LED substitute light source(s), all measurements, photometric and colorimetric, shall be repeated using the LED substitute light source(s) prescribed.
- 4.8.1.7. If not otherwise specified, the intensities shall be measured with the light source continuously lit.
- 4.8.1.8. In case the results of measurements should be challenged, measurements shall be carried out in such a way as to meet the following requirements:
 - 4.8.1.8.1. The distance of measurement shall be such that the law of the inverse of the square of the distance is applicable;
 - 4.8.1.8.2. The measuring equipment shall be such that the angular aperture of the receiver viewed from the reference centre of the light is comprised between 10' and 1 degree;
 - 4.8.1.8.3. The intensity requirement for a particular direction of observation shall be deemed to be satisfied if that requirement is met in a direction deviating by not more than one-quarter of a degree from the direction of observation.
- 4.8.1.9. The limits of the apparent surface in the direction of the reference axis of a light-signalling lamp shall be determined. However, in the case of category 5 and 6 direction indicators, the limits of the light emitting surface shall be determined. This requirement shall not apply to rear-registration plate illuminating lamps.
- 4.8.1.10. In the case of a lamp, which is intended to be mounted inside the vehicle a sample plate or sample plates (in case of different possibilities) as supplied (see paragraph 3.1.2.8.) shall be positioned in front of the lamp to be tested, in the geometrical position(s) as described in the application drawing(s) (see paragraph 3.1.2.2.).
- 4.8.2. Operation of the lamp for testing.

Unless otherwise specified, the voltage supplied at the lamp shall be either 6.75 V (6 Volt-Systems), 13.5 V (12 Volt-Systems) or 28 V (24 Volt-Systems).

 - 4.8.2.1. In case of a lamp controlled by an electronic light source control gear or a variable intensity control, the lamp shall be operated as specified by the applicant;

The test laboratory may require the electronic light source control gear or the variable intensity control
 - 4.8.2.2. In case of a lamp not controlled by an electronic light source control gear or a variable intensity control:
 - 4.8.2.2.1. in the case of light source module(s) or non-replaceable light source(s) the lamp shall be operated as specified by the applicant;
 - 4.8.2.2.2. in the case of replaceable UN approved light source(s) the light sources shall be operated at the reference/objective luminous flux or alternatively at a

different luminous flux with a proportional correction on the measured luminous intensities;

4.8.2.3. In case of lamps equipped with multiple replaceable UN approved light sources:

4.8.2.3.1. shall be operated at a voltage or electrical current setting such that the actual luminous fluxes of the light sources do not deviate by more than 5 per cent from the average luminous flux of the light sources. The measured luminous intensities shall be corrected proportionally for the difference between the average luminous flux and the applicable reference/objective luminous flux.

4.8.2.3.2. alternatively, may be tested by using one light source in each of the individual lamp holder positions operating at the reference/objective luminous flux and application of the sum of the measured luminous intensities for each direction.

4.8.2.4. The identification of an electronic light source control gear if applicable or variable intensity control if applicable and/or the voltage applied, including the tolerances, shall be noted in the communication form in Annex 1.

4.8.3. Luminous intensities

4.8.3.1. If not otherwise specified, the intensity of light emitted by each of the two samples supplied shall:

(a) On the reference axis (HV),
be not less than the minimum specified in the table of the pertinent function in paragraph 5.;

(b) In no direction where the lamp is visible,
exceed the maximum, specified in the table of the pertinent function in paragraph 5.;

(c) Outside the reference axis,
- be not less than the product of the minimum specified in the table of the pertinent function in paragraph 5., by the percentage specified in the pertinent light distribution figure reproduced in Annex 3 for each direction in question, or

- be not less than the intensity value as specified in the pertinent light distribution figure reproduced in Annex 3 for each direction in question;

(d) Within the angles of geometric visibility defined in the tables in Annex 2,
be not less than the minimum specified in the table of the pertinent function in paragraph 5.

The provisions of the relevant paragraphs of Annex 3 on local variations of intensity shall be observed.

4.8.3.1.1. In addition, in order to verify the visibility of red light towards the front and/or white light towards the rear of a vehicle required in UN Regulation No.48, the applicant may request an additional test, to show that in the angular field from 165° to 180° outboard in horizontal direction and -2.5° to +5° in vertical direction, the maximum intensity is not more than $2.5 \cdot 10^{-1}$ cd. This additional test may be conducted taking into account the influence of the vehicle body.

4.8.3.2. When an assembly of two independent lamps, to be type approved as lamps marked "D" and having the same function, is deemed to be a single lamp, it shall comply with the requirements for:

(a) Maximum intensity if all lamps together are lit;

(b) Minimum intensity if either lamp has failed.

4.8.3.3. An interdependent lamp system shall meet the requirements when all its interdependent lamps are operated together.

However:

- (a) If the interdependent lamp system providing the rear position lamp is partly mounted on the fixed component and partly mounted on a movable component, the interdependent lamp(s) specified by the applicant shall meet the outboard geometric visibility colorimetric and photometric requirement, at all fixed positions of the movable component(s). In this case, the inboard geometric visibility requirement is deemed to be satisfied if this (these) interdependent lamp(s) still conform to the photometric values prescribed in the field of light distribution for the approval of the device, at all fixed positions of the moveable component(s);
- (b) If the interdependent lamp system providing the rear direction indicator function is partly mounted on the fixed component and partly mounted on a movable component, the interdependent lamp(s) specified by the applicant shall meet the geometric visibility, colorimetric and photometric requirement, at all fixed positions of the movable component(s). This does not apply to interdependent direction indicator lamp(s) intended for fitting on vehicle(s) where, to fulfil or complete the geometric visibility angle, additional lamps are activated when the movable component is in any fixed open position, provided that these additional lamps satisfy all the position, photometric and colorimetric requirements applicable to the direction indicator lamps installed on the movable component.

4.8.3.4. The variable intensity control shall not generate signals which cause luminous intensities:

4.8.3.4.1. Outside the range specified in paragraph 5.; and

4.8.3.4.2. Exceeding the respective steady luminous intensity maximum specified in paragraph 5. for the specific lamp:

- (a) For systems depending only on daytime and night-time conditions: under night-time conditions;
- (b) For other systems: under standard conditions².

4.8.3.5. If a rear position lamp and/or a rear end-outline marker lamp is reciprocally incorporated with a stop lamp producing either steady or variable luminous intensity, the ratio between the luminous intensities actually measured of the two lamps when turned on simultaneously at the intensity of the rear position lamp or end-outline marker lamp when turned on alone should be at least 5:1 in the field delimited by the straight horizontal lines passing through $\pm 5^\circ$ V and the straight vertical lines passing through $\pm 10^\circ$ H of the light distribution table.

If the one or both of the two reciprocally incorporated lamps contain(s) more than one light source and is (are) considered as a single lamp, the values to be considered are those obtained with all sources in operation;

4.8.3.6. Tests for compliance of the luminous intensities shall be carried out according to Annex 8.

4.9. Colour of light emitted

The colour of the light emitted shall be measured inside the field of the light distribution grid defined for the specific function in the relevant paragraph of Annex 3. To check these colorimetric characteristics, the test procedure

² Good visibility (meteorological optical range MOR > 2,000 m defined according to WMO, Guide to Meteorological Instruments and Methods of Observation, Sixth Edition, ISBN: 92-63-16008-2, pp 1.9.1/1.9.11, Geneva 1996) and clean lens.

described in paragraph 4.8. shall be applied. Outside this field no sharp variation of colour shall be observed.

However, for lamps equipped with non-replaceable light sources, the colorimetric characteristics should be verified with the light sources present in the lamp, in accordance with relevant subparagraphs of paragraph 4.8.

- 4.9.1. For lamps (functions) using different light source technologies, the colorimetric characteristics shall be checked for each light source technology separately according to the applicable provisions in paragraphs 4.8.1. and 4.8.2.

The test laboratory may require from the applicant samples allowing to supply the different light source(s) separately.

5. Specific technical requirements

- 5.1. Front position lamps (A, MA) and front end-outline marker lamps (AM)

- 5.1.1. Luminous intensity and standard light distribution:

The light emitted by each of the two samples supplied shall meet the requirements in Table 3.

Table 3

Luminous intensities for front position and front end-outline marker lamps

Front position lamps, front end-outline marker lamp of categories	Minimum luminous intensity in cd (Par. 4.8.3.1. (a))	Maximum luminous intensity in cd when used as (Par. 4.8.3.1. (b))		Standard light distribution (Par. 4.8.3.1. (c))	Angles of geometric visibility (Par. 4.8.3.1. (d))	
		A single lamp	A lamp marked "D" (Par. 3.3.2.5.2)		Definition	Minimum luminous intensity in cd
A, MA or AM	$4 \cdot 10^0$	$1.40 \cdot 10^2$	$7.0 \cdot 10^1$	Figure A3-I	Table A2-1	$5 \cdot 10^{-2}$

- 5.1.2. Minimum luminous intensity within the angles of geometric visibility:

See Table 3.

- 5.1.3. Minimum or maximum area of apparent surface:

No requirements.

- 5.1.4. Measurement:

For end-outline marker lamps (AM) the standard light distribution may be considered at the request of the applicant from VV line to the outboard only.

- 5.1.5. Additional specific requirements:

No.

- 5.1.6. Failure provisions:

See paragraph 4.6.

- 5.1.7. Colour:

The colour of the light emitted shall be white, however the lamp identified by symbol MA may be amber.

- 5.2. Rear position lamps (R1, R2, MR) and rear end-outline marker lamps, (RM1, RM2)

- 5.2.1. Luminous intensity and standard light distribution:

The light emitted by each of the two samples supplied shall meet the requirements in Table 4.

However, a luminous intensity of $6.0 \cdot 10^1$ cd shall be permitted for rear position lamps reciprocally incorporated with stop lamps below a plane forming an angle of 5° with and downward from the horizontal plane.

Table 4

Luminous intensities for rear position and rear end-outline marker lamps

<i>Rear position lamps, rear end-outline marker lamps of categories</i>	<i>Minimum luminous intensity in cd (Par. 4.8.3.1. (a))</i>	<i>Maximum luminous intensity in cd when used as (Par. 4.8.3.1. (b))</i>		<i>Standard light distribution (Par. 4.8.3.1. (c))</i>	<i>Angles of geometric visibility (Par. 4.8.3.1. (d))</i>	
		<i>A single lamp</i>	<i>A lamp marked "D" (Par.3.3.2.5.2.)</i>		<i>Definition</i>	<i>Minimum luminous intensity in cd</i>
R1, MR or RM1 (steady)	$4 \cdot 10^0$	$1.7 \cdot 10^1$	$8.5 \cdot 10^0$	Figure A3-I	Table A2-1	$5 \cdot 10^{-2}$
R2 or RM2 (variable)	$4 \cdot 10^0$	$4.2 \cdot 10^1$	$2.1 \cdot 10^1$	Figure A3-I	Table A2-1	$5 \cdot 10^{-2}$

5.2.2. Minimum luminous intensity within the angles of geometric visibility:

See Table 4

5.2.3. Minimum or maximum area of apparent surface:

No requirements.

5.2.4. Measurement:

For end-outline marker lamps (RM1, RM2) the standard light distribution may be considered at the request of the applicant from VV line to the outboard only.

5.2.5. Additional specific requirements:

No.

5.2.6. Failure provisions:

See paragraph 4.6.

5.2.7. Colour:

The colour of light emitted shall be red.

5.3. Parking lamps (77R)

5.3.1. Luminous intensity and standard light distribution:

The light emitted by each of the two samples supplied shall meet the requirements in Table 5.

However, a luminous intensity of $6.0 \cdot 10^1$ cd shall be permitted for parking lamps directed to the rear incorporated with stop lamps below a plane forming an angle of 5° with and downward from the horizontal plane;

Table 5

Luminous intensities for parking lamps

<i>Parking lamps</i>	<i>Minimum luminous intensity in cd (Par. 4.8.3.1. (a))</i>	<i>Maximum luminous intensity in cd (Par. 4.8.3.1. (b))</i>	<i>Standard light distribution (Par. 4.8.3.1. (c))</i>	<i>Angles of geometric visibility (Par. 4.8.3.1. (d))</i>	
				<i>Definition</i>	<i>Minimum luminous intensity in cd</i>
forward facing	$2 \cdot 10^0$	$6.0 \cdot 10^1$	Figure A3-I	Table A2-1	$5 \cdot 10^{-2}$
rearward facing	$2 \cdot 10^0$	$3.0 \cdot 10^1$	Figure A3-I	Table A2-1	$5 \cdot 10^{-2}$

5.3.2. Minimum luminous intensity within the angles of geometric visibility

See Table 5.

- 5.3.3. Minimum or maximum area of apparent surface:
No requirements.
- 5.3.4. Measurement:
For front and rear parking lamps the standard light distribution may be considered at the request of the applicant from VV line to the outboard only.
- 5.3.5. Additional specific requirements:
No.
- 5.3.6. Failure provisions:
See paragraph 4.6.
- 5.3.7. Colour:
The colour of light emitted shall:
(a) For front parking lamps be white;
(b) For rear parking lamps be red;

5.4. Daytime running lamps (RL)

5.4.1. Luminous intensity and standard light distribution:

The light emitted by each of the two samples supplied shall meet the requirements in Table 6.

Table 6

Luminous intensities for daytime running lamps

<i>Daytime running lamp</i>	<i>Minimum luminous intensity in cd (Par. 4.8.3.1. (a))</i>	<i>Maximum luminous intensity in cd when used as (Par. 4.8.3.1. (b))</i>		<i>Standard light distribution (Par. 4.8.3.1. (c))</i>	<i>Angles of geometric visibility (Par. 4.8.3.1. (d))</i>	
		<i>A single lamp</i>	<i>A lamp marked "D" (Par. 3.3.2.5.2)</i>		<i>Definition</i>	<i>Minimum luminous intensity in cd</i>
RL	$4.00 \cdot 10^2$	$1.20 \cdot 10^3$	$6.00 \cdot 10^2$	Figure A3-II	Table A2-1	$1.0 \cdot 10^0$

- 5.4.2. Minimum luminous intensity within the angles of geometric visibility
See Table 6.
- 5.4.3. Minimum or maximum area of apparent surface:
The area of the apparent surface in the direction of the axis of reference of the daytime running lamp shall be not less than 25 cm² and not more than 200 cm².
When a daytime running lamp is to be type approved as a lamp marked "D", the apparent surface of such a lamp shall not be more than 100 cm².
- 5.4.4. Measurement:
No additional requirements.
- 5.4.5. Additional specific requirements:
The daytime running lamp shall be subjected to the heat resistance test specified in Annex 6.
- 5.4.6. Failure provisions:
See paragraph 4.6.
- 5.4.7. Colour:
The colour of the light emitted shall be white.

5.5. Stop lamps (S1, S2, S3, S4, MS)

5.5.1. Luminous intensity and standard light distribution:

The light emitted by each of the two samples supplied shall meet the requirements in Table 7.

Table 7

Luminous intensities for stop lamps

Stop lamp of category	Minimum luminous intensity in cd (Par. 4.8.3.1. (a))	Maximum luminous intensity in cd when used as (Par. 4.8.3.1. (b))		Standard light distribution (Par. 4.8.3.1. (c))	Angles of geometric visibility (Par. 4.8.3.1. (d))	
		A single lamp	A lamp marked "D" (Par. 3.3.2.5.2)		Definition	Minimum luminous intensity in cd
S1 (steady)	$6.0 \cdot 10^1$	$2.60 \cdot 10^2$	$1.30 \cdot 10^2$	Figure A3-I	Table A2-1	$3 \cdot 10^{-1}$
S2 (variable)	$6.0 \cdot 10^1$	$7.30 \cdot 10^2$	$3.65 \cdot 10^2$	Figure A3-I	Table A2-1	$3 \cdot 10^{-1}$ (day) $7 \cdot 10^{-2}$ (night)
S3 (steady)	$2.5 \cdot 10^1$	$1.10 \cdot 10^2$	$5.5 \cdot 10^1$	Figure A3-III	Table A2-1	$3 \cdot 10^{-1}$
S4 (variable)	$2.5 \cdot 10^1$	$1.60 \cdot 10^2$	$8.0 \cdot 10^1$	Figure A3-III	Table A2-1	$3 \cdot 10^{-1}$ (day) $7 \cdot 10^{-2}$ (night)
MS (steady)	$4.0 \cdot 10^1$	$2.60 \cdot 10^2$	$1.30 \cdot 10^2$	Figure A3-I	Table A2-1	$3 \cdot 10^{-1}$

5.5.2. Minimum luminous intensity within the angles of geometric visibility

See Table 7.

5.5.3. Minimum or maximum area of apparent surface:

No requirements.

5.5.4. Measurement:

5.5.4.1. In the case of a category S3 or S4 stop lamp, which is intended to be mounted inside the vehicle, the colorimetric characteristics shall be verified with the worst-case combination(s) of lamp and rear window(s) or sample plate(s).

5.5.4.2. For stop lamps pair (MS) the standard light distribution may be considered at the request of the applicant from VV line to the outboard only.

5.5.5. Additional specific requirements:

No.

5.5.6. Failure provisions:

See paragraph 4.6.

5.5.7. Colour:

The colour of light emitted shall be red.

5.6. Direction indicator lamps (1, 1a, 1b, 2a, 2b, 5, 6, 11, 11a, 11b, 11c, 12)

5.6.1. Luminous intensity and standard light distribution:

The light emitted by each of the two samples supplied shall meet the requirements in Table 8 where the minimum luminous intensities shall be fulfilled:

- (a) In the case of direction indicators of categories 1, 1a, 1b, 2a, 2b, 11, 11a, 11b, 11c and 12 in the reference axis; or
- (b) in the case of direction indicators of categories 5 and 6 in direction A according to Annex 2.

Table 8
Luminous intensities for direction indicator lamps

Direction indicator of categories	Minimum luminous intensity in cd (Par. 4.8.3.1. (a))	Maximum luminous intensity in cd when used as (Par. 4.8.3.1. (b))		Standard light distribution (Par. 4.8.3.1. (c))	Angles of geometric visibility (Par. 4.8.3.1. (d))	
		A single lamp	A lamp marked "D" (Par.3.3.2.5.2)		Definition	Minimum luminous intensity in cd
1	$1.75 \cdot 10^2$	$1.20 \cdot 10^3$	$6.00 \cdot 10^2$	Figure A3-I	Table A2-1	$3 \cdot 10^{-1}$
1a	$2.50 \cdot 10^2$	$1.20 \cdot 10^3$	$6.00 \cdot 10^2$	Figure A3-I	Table A2-1	$3 \cdot 10^{-1}$
1b	$4.00 \cdot 10^2$	$1.20 \cdot 10^3$	$6.00 \cdot 10^2$	Figure A3-I	Table A2-1	$7 \cdot 10^{-1}$
2a (steady)	$5.0 \cdot 10^1$	$5.00 \cdot 10^2$	$2.50 \cdot 10^2$	Figure A3-I	Table A2-1	$3 \cdot 10^{-1}$
2b (variable)	$5.0 \cdot 10^1$	$1.00 \cdot 10^3$	$5.00 \cdot 10^2$	Figure A3-I	Table A2-1	$3 \cdot 10^{-1}$ (day) $7 \cdot 10^{-2}$ (night)
5	$6 \cdot 10^{-1}$	$2.80 \cdot 10^2$	$1.40 \cdot 10^2$	Table A2-2	Table A2-2	$6 \cdot 10^{-1}$
6	$5.0 \cdot 10^1$	$2.80 \cdot 10^2$	$1.40 \cdot 10^2$	Figure A3-IV	N.A.	N.A.
11	$9.0 \cdot 10^1$	$1.20 \cdot 10^3$	$6.00 \cdot 10^2$	Figure A3-I	Table A2-1	$3 \cdot 10^{-1}$
11a	$1.75 \cdot 10^2$	$1.20 \cdot 10^2$	$6.00 \cdot 10^2$	Figure A3-I	Table A2-1	$3 \cdot 10^{-1}$
11b	$2.50 \cdot 10^2$	$1.20 \cdot 10^2$	$6.00 \cdot 10^2$	Figure A3-I	Table A2-1	$3 \cdot 10^{-1}$
11c	$4.00 \cdot 10^2$	$1.20 \cdot 10^2$	$6.00 \cdot 10^2$	Figure A3-I	Table A2-1	$3 \cdot 10^{-1}$
12	$5.0 \cdot 10^1$	$5.00 \cdot 10^2$	$2.50 \cdot 10^2$	Figure A3-I	Table A2-1	$3 \cdot 10^{-1}$

5.6.2. Minimum luminous intensity within the angles of geometric visibility

See Table 8.

5.6.3. Minimum or maximum area of apparent surface:

No requirements.

5.6.4. Measurement:

In general, the intensities shall be measured with the light source(s) continuously alight.

However, depending on the construction of the lamp, for example, the use of light-emitting diodes (LED), or the need to take precautions to avoid overheating, it is allowed to measure the lamps in flashing mode.

(a) This shall be achieved by switching with a frequency of $f = 1.5 \pm 0.5$ Hz with the pulse width greater than 0.3 s, measured at 95 per cent peak light intensity. In all other cases the voltage as required in paragraph 4.8. shall be switched with a rise time and fall time shorter than 0.01 s; no overshoot is allowed;

(b) In the case of measurements taken in flashing mode the reported luminous intensity shall be represented by the maximum intensity.

5.6.5. Additional specific requirements:

For direction indicator lamps of categories 1, 1a, 1b, 2a, 2b, 11, 11a, 11b, 11c or 12 the flash may be produced by sequential activation of their light sources if the following conditions are met:

(a) Each light source, after its activation, shall remain lit until the end of the ON cycle;

(b) The sequence of activation of the light sources shall produce a signal which proceeds in a uniform progressive manner from inboard towards the outboard edge of the light emitting surface;

(c) It shall be one signal with no interruption and no vertical oscillations (e.g. not more than one change of direction along the vertical axis). The distance between two adjacent/tangential distinct parts of the light emitting surface of the sequential direction indicator shall not exceed

50mm, when measured perpendicularly to the reference axis, instead of the values defined in paragraph 5.7.2. of UN Regulation No. 48 or paragraph 5.7.2. of UN Regulation No. 86 or paragraph 5.6.2. of UN Regulation No. 53. These interruptions of the signal shall not create any overlap in the vertical axis between the different parts, from inboard towards the outboard of the vehicle, and shall not be used for any other lighting or light signalling functions;

- (d) The variation shall finish no more than 200ms after the beginning of the ON cycle;
- (e) The orthogonal projection of the light emitting surfaces of the direction indicator in the direction of the axis of reference shall be circumscribed by a rectangle on a plane normal to the axis of reference and having its longer sides parallel to the H-plane. The ratio of the horizontal to the vertical sides shall not be less than 1.7.

Compliance to the conditions mentioned above shall be verified in flashing mode.

5.6.6. Failure provisions.

See paragraph 4.6.

5.6.7. Colour:

The colour of light emitted shall be amber.

5.7. Side marker lamps (SM1, SM2)

5.7.1. Luminous intensity and standard light distribution:

The light emitted by each of the two samples supplied shall meet the requirements in Table 9.

In addition, for red side marker lamp, in the angular field from 60° to 90° in horizontal direction and $\pm 20^\circ$ in vertical direction towards the front of the vehicle, the maximum intensity is limited to $2.5 \cdot 10^{-1}$ cd.

Table 9

Luminous intensities for side marker lamps

Side marker lamp of categories	Minimum luminous intensity in cd in the axis of reference (Par. 4.8.3.1. (a))	Minimum luminous intensity in cd within the standard light distribution (Par. 4.8.3.1. (c))	Maximum luminous intensity in cd (Par. 4.8.3.1. (b))	Standard light distribution (Par. 4.8.3.1. (c))	Angles of geometric visibility (Par. 4.8.3.1. (d))	
					Definition	Minimum luminous intensity in cd
SM1	$4.0 \cdot 10^0$	$6 \cdot 10^{-1}$	$2.50 \cdot 10^1$	Figure A3-VII	Table A2-3	$6 \cdot 10^{-1}$
SM2	$6 \cdot 10^{-1}$	$6 \cdot 10^{-1}$	$2.50 \cdot 10^1$	Figure A3-VIII	Table A2-3	$6 \cdot 10^{-1}$

5.7.2. Minimum luminous intensity within the angles of geometric visibility

See Table 9.

5.7.3. Minimum or maximum area of apparent surface:

No requirements.

5.7.4. Measurement:

For SM1 and SM2 category of side marker lamps it may be sufficient to check only five points selected by the Type Approval Authority.

5.7.5. Additional specific requirements:

No.

5.7.6. Failure provisions:

See paragraph 4.6.

5.7.7. Colour:

The colour of the light emitted shall be amber.

5.8. Reversing lamps (AR)

5.8.1. Luminous intensity and standard light distribution:

The light emitted by each of the two samples supplied shall meet the requirements in Table 10.

However, in the case where the reversing lamp is intended to be installed on a vehicle exclusively in a pair of devices, the photometric intensity may be verified only up to an angle of 30° inwards where a photometric value of at least $2.5 \cdot 10^1$ cd shall be satisfied.

This condition shall be clearly explained in the application for approval and relating documents (see paragraph 3.1.).

Moreover, in the case where the type approval will be granted applying the condition above, a statement in paragraph 9.1.3. of the communication form (see Annex 1) will inform that the device shall only be installed in a pair.

Table 10

Luminous intensities for reversing lamps

Reversing lamps of category	Minimum luminous intensity in cd (Par. 4.8.3.1. (a))	Maximum luminous intensity in cd (Par. 4.8.3.1. (b))			Standard light distribution (Par. 4.8.3.1. (c))	Angles of geometric visibility (Par. 4.8.3.1. (d))	
		in or above the h-plane	below the h-plane, down to 5°D	below 5°D		Definition	Minimum luminous intensity in cd
AR	$8.0 \cdot 10^1$	$3.00 \cdot 10^2$	$6.00 \cdot 10^2$	$8.00 \cdot 10^3$	Figure A3-V	N.A.	N.A.

5.8.2. Minimum luminous intensity within the angles of geometric visibility

No requirements.

5.8.3. Minimum or maximum area of apparent surface:

No requirements.

5.8.4. Measurement:

No additional requirements.

5.8.5. Additional specific requirements:

No.

5.8.6. Failure provisions:

See paragraph 4.6.

5.8.7. Colour:

The colour of light emitted shall be white.

5.9. Rear fog lamps (F1, F2)

5.9.1. Luminous intensity and standard light distribution:

The light emitted by each of the two samples supplied shall meet the requirements in Table 11.

Table 11
Luminous intensities for rear fog lamps

Rear fog lamps of categories	Minimum luminous intensity in cd (Par. 4.8.3.1. (a))	Maximum luminous intensity in cd when used as (Par. 4.8.3.1. (b))	Standard light distribution (Par. 4.8.3.1. (c))	Angles of geometric visibility (Par. 4.8.3.1. (d))	
				Definition	Minimum luminous intensities in cd
F1 (steady)	$1.50 \cdot 10^2$	$3.00 \cdot 10^2$	Figure A3-VI	N.A.	N.A.
F2 (variable)	$1.50 \cdot 10^2$	$8.40 \cdot 10^2$	Figure A3-VI	N.A.	N.A.

- 5.9.2. Minimum luminous intensity within the angles of geometric visibility
No requirements.
- 5.9.3. Minimum or maximum area of apparent surface:
The area of the apparent surface in the direction of the reference axis shall not exceed 140 cm².
- 5.9.4. Measurement:
No additional requirements.
- 5.9.5. Additional specific requirements:
The rear fog lamp shall be subjected to the heat resistance test specified in Annex 6.
- 5.9.6. Failure provisions:
See paragraph 4.6.
- 5.9.7. Colour:
The colour of light emitted shall be red.
- 5.10. Manoeuvring lamps (ML)
- 5.10.1. Luminous intensity and standard light distribution:
- 5.10.1.1. The intensity of light emitted shall not exceed $5.00 \cdot 10^2$ cd in all directions in which the light can be observed, when installed in any mounting position specified by the applicant.
- 5.10.1.2. The lamp must be so designed that the light emitted directly towards the side, the front or the rear of the vehicle does not exceed $5 \cdot 10^{-1}$ cd within the angular field as defined below.
- (a) The vertical minimum angle ϕ_{\min} (in degrees) is:
 $\phi_{\min} = \arctan((1-h)/10)$; where h is mounting height in m
- (b) The vertical maximum angle ϕ_{\max} (in degrees) is: $\phi_{\max} = \phi_{\min} + 11.3$
The measurement shall be limited to a horizontal angle ranging from +90° to -90° with respect to the line which cuts the reference axis and which is perpendicular to the vertical longitudinal plane of the vehicle.
- 5.10.2. Minimum luminous intensity within the angles of geometric visibility
No requirements.
- 5.10.3. Minimum or maximum area of apparent surface:
No requirements.
- 5.10.4. Measurement:
The measurement distance shall be 3.0 m minimum.

- 5.10.5. Additional specific requirements:
No.
- 5.10.6. Failure provisions:
See paragraph 4.6.
- 5.10.7. Colour:
The colour of light emitted shall be white.
- 5.11. Rear registration plate illuminating lamp (L, LM1)
- 5.11.1. Luminous intensity:
Not applicable
- 5.11.2. Photometric characteristics:
For the approval of this device, the illuminated area to be occupied by the plate is determined. The illuminated areas are grouped in the following categories:
- Category 1a: illuminated area of at least 340 x 240 mm (Figure A3-IX).
 - Category 1b: illuminated area of at least 520 x 120 mm (Figure A3-X).
 - Category 1c: illuminated area of at least 255 x 165 mm, for use on agricultural or forestry tractors, (Figure A3-XI).
 - Category 2a: illuminated area of at least 330 x 165 mm (Figure A3-XII).
 - Category 2b: illuminated area of at least 440 x 220 mm (Figure A3-XIII).
 - Category 1: illuminated area of at least 130 x 240 mm for use on a vehicle of category L (Figure A3-XIV).
 - Category 2: illuminated area of at least 200 x 280 mm for use on a vehicle of category L (Figure A3-XV).
- At each of the points of measurement for the categories of illuminated areas shown in paragraph 3. of Annex 3, the luminance B shall be at least
- (a) For categories 1a, 1b, 1c, 2a and 2b equal to $2.5 \cdot 10^0$ cd/m²;
 - (b) For categories 1 and 2 equal to $2 \cdot 10^0$ cd/m².
- The gradient of the luminance between the values B_1 and B_2 , measured at any two points 1 and 2 selected from among those mentioned above, shall not exceed $2 \times B_0$ /cm, B_0 being the minimum luminance measured at the various points, i.e.:
- $$\frac{B_2 - B_1}{\text{distance } 1 - 2 \text{ in cm}} \leq 2 \times B_0/\text{cm}$$
- 5.11.3. Minimum or maximum area of apparent surface:
Not applicable.
- 5.11.4. Measurement:
The luminance measurements shall be made on a diffuse colourless surface with known diffuse reflection factor. The diffuse colourless surface shall have the dimensions of the registration plate or the dimension exceeding one measuring point. Its centre shall be placed in the centre of the positions of the measuring points.
This (These) diffuse colourless surface(s) shall be placed in the position normally occupied by the registration plate and 2 mm in front of its holder.
Luminance measurements shall be made perpendicularly to the surface of the diffuse colourless surface with the tolerance of 5° in each direction at the points shown in paragraph 3. of Annex 3, each point representing a circular area of

25 mm in diameter. The measured luminance shall be corrected for the diffuse reflection factor 1.0.

5.11.5. Additional specific requirements:

5.11.5.1. The devices for the illumination of rear-registration plates of categories 1a, 1b, 1c, 2a and 2b shall be so constructed that the whole surface of the plate will be visible within the angles given in Part D of Annex 2.

5.11.5.2. Incidence of the light

The manufacturer of the rear registration plate illuminating lamp shall specify one or more or a field of positions in which the device is to be fitted in relation to the space for the registration plate; when the lamp is placed in the position(s) specified by the manufacturer the angle of incidence of the light on the surface of the plate does not exceed 82° at any point on the surface to be illuminated, this angle being measured from the extremity of the device's illuminating area which is furthest from the surface of the plate. If there is more than one part, the foregoing requirement shall apply only to that part of the plate intended to be illuminated by the device concerned.

When the device has one outer edge of the illuminating surface that is parallel to the surface of the registration plate, the extremity of the illuminating surface of the device which is furthest from the surface of the plate is the middle point of the edge of the illuminating surface, which is parallel to the plate and is furthest from the surface of the plate.

The device must be so designed that no light is emitted directly towards the rear, with the exception of red light if the device is combined or grouped with a rear lamp.

5.11.6. Failure provisions:

See paragraph 4.6.

5.11.7. Colour:

The colour of the light emitted shall be sufficiently colourless not to cause any appreciable change in the colour of the registration plate.

6. Conformity of production

6.1. Lamps shall be so manufactured as to conform to the type approved under this Regulation. The compliance with the requirements set forth in paragraph 5. shall be verified as follows:

6.1.1. The minimum requirements for conformity of production control procedures set forth in Annex 4 shall be complied with;

6.1.2. The minimum requirements for sampling by an inspector set forth in Annex 5 shall be complied with;

6.1.3. No measured value deviates unfavourably by more than 20 per cent from the values prescribed in this Regulation.

For the minimum values required throughout the fields specified in Annexes 2 and 3 the measured values shall correspond to the values shown in Table 12:

Table 12
20 and 30 per cent values for CoP

<i>Required minimum value / cd</i>	<i>Equivalent 20 per cent /cd</i>	<i>Equivalent 30 per cent /cd</i>
$7 \cdot 10^{-1}$	$5 \cdot 10^{-1}$	$3 \cdot 10^{-1}$
$6 \cdot 10^{-1}$	$4 \cdot 10^{-1}$	$2 \cdot 10^{-1}$
$3 \cdot 10^{-1}$	$2 \cdot 10^{-1}$	$1 \cdot 10^{-1}$
$7 \cdot 10^{-2}$	$5 \cdot 10^{-2}$	$3 \cdot 10^{-2}$
$5 \cdot 10^{-2}$	$3 \cdot 10^{-2}$	$2 \cdot 10^{-2}$

- 6.1.3.1. However, in the case of daytime running lamp, intended for installation on vehicles of category L3, and whose designed maximum luminous intensity does not exceed $7.00 \cdot 10^2$ cd as identified in Annex 1, $7.00 \cdot 10^2$ cd shall be applied as the maximum luminous intensity for conformity of production procedures set forth in Annexes 4 and 5.
- 6.1.3.2. For rear-registration plate illuminating lamps with respect to the gradient of luminance the unfavourable deviation shall be as shown in Table 13:

Table 13
20 and 30 per cent values for CoP, Rear-registration plate illuminating lamps

<i>Unfavourable deviation</i>		
2.5 x Bo/cm	comparable to	20 per cent
3.0 x Bo/cm	comparable to	30 per cent

- 6.2. The authority which has granted type approval may at any time verify the conformity control methods applied in each production facility. The normal frequency of these verifications shall be once every two years.
- 6.3. In the case where doubt exists in respect to compliance of the non-replaceable filament light source(s) with lifetime requirements and/or, in the case of colour coated filament light sources, with colour endurance requirements, as specified in paragraph 4.11. of IEC 60809, Edition 4, conformity shall be checked as specified in paragraph 4.11 of IEC 60809, Edition 4.
- 6.4. Testing with LED substitute light sources is exempted from conformity of production control.

7. Transitional provisions

7.1. General

- 7.1.1. Contracting Parties applying this Regulation shall continue to accept UN type-approvals of the lamps (functions), to any of the preceding series of amendments to this Regulation, which are not affected by the changes introduced by the latest series of amendments.

To verify this, the change index applicable to the pertinent lamp (function) shall not differ from its change index as indicated in the latest series of amendments.

- 7.1.2. Contracting Parties applying this Regulation shall not refuse to grant extensions to UN type-approvals according to any preceding series of amendments to this Regulation.

- 7.2. For the 01 series of amendments

- 7.2.1. As from the official date of entry into force of the 01 series of amendments, no Contracting Party applying this Regulation shall refuse to grant or refuse to accept UN type approvals under this Regulation as amended by the 01 series of amendments.
- 7.2.2. As from 1 September 2026 Contracting Parties applying this Regulation shall not be obliged to accept UN type approvals to the preceding series of amendments, first issued after 1 September 2026.
- 7.2.3. Contracting Parties applying this Regulation shall continue to accept type approvals to the preceding series of amendments to this Regulation, first issued before 1 September 2026.
- 7.2.4. Contracting Parties applying this Regulation shall continue to grant and accept type approvals for devices (equipment and parts) on the basis of any previous series of amendments, provided that the devices (equipment and parts) are intended as replacements for fitting to vehicles in use and that it is not technically feasible for the devices (equipment and parts) in question to satisfy the new requirements contained in this Regulation as amended by the 01 series of amendments.
- 7.2.5. Notwithstanding the transitional provisions above, Contracting Parties whose application of this Regulation comes into force after the date of entry into force of the 01 series of amendments are not obliged to accept UN type approvals which were granted in accordance with any of the preceding series of amendments to this Regulation.
- 7.2.6. Contracting Parties applying this Regulation shall continue to accept UN type approvals to the preceding series of amendments to this Regulation, for the equipment or parts which are not affected by the changes introduced by the 01 series of amendments.
- 7.2.7. Contracting Parties applying this Regulation shall not refuse to grant type approvals according to any preceding series of amendments to this Regulation or extensions thereof.

Annex 1

Communication

(Maximum format: A4 (210 x 297 mm))

	issued by:	Name of Administration:	
		
Concerning: ²		Approval granted Approval extended Approval refused Approval withdrawn Production definitively discontinued	
of a type of lamp pursuant to UN Regulation No.148			
Lamp: ²		Rear-registration plate illuminating lamp Direction indicator lamp Stop lamp Position lamp End-outline marker lamp Reversing lamp Manoeuvring lamp Rear fog lamp Parking lamp Daytime running lamp Side marker lamp	
Category of the lamp:		Change index:	
Approval No:		Unique Identifier (UI) (If applicable)	

1. Trade name or mark of the lamp:
2. Manufacturer's name for the type of lamp:
3. Manufacturer's name and address:
4. If applicable, name and address of the manufacturer's representative:
.....

¹ Distinguishing number of the country which has granted/extended/refused/withdrawn approval (see approval provisions in this Regulation).

² Strike out what does not apply

-
5. Submitted for approval on:
6. Technical Service responsible for conducting approval tests:
7. Date of report issued by that Service:
8. Number of report issued by that Service:
9. Concise description:
- 9.1. In case of
- 9.1.1. A rear-registration plate illuminating lamp:
- Geometrical conditions of installation (position(s) and inclination(s) of the device in relation to the space to be occupied by the registration plate and/or different inclinations of this space):
- 9.1.1.1. Category(ies) of illuminated area: 1a, 1b, 1c, 2a, 2b, 1, 2²
- 9.1.2. A direction indicator:
- Sequential activation of light sources: yes/no²
- 9.1.3. A reversing lamp:
- The lamp shall be installed on a vehicle only as part of a pair of lamps: yes/no²
- 9.1.4. A manoeuvring lamp:
- The maximum mounting height:
- 9.1.5. A daytime running lamp
- The daytime running lamp is intended exclusively for installation on vehicles of category L3, and its designed maximum luminous intensity does not exceed $7.00 \cdot 10^2$ cd: yes/no²
- 9.1.6. In case of a rear position lamp reciprocally incorporated with a stop lamp, the rear position/stop lamp are provided by multiple light sources: yes/no²
- 9.2. By light signalling function and category:
- For mounting either outside or inside or both²
- Colour of light emitted: red/white/amber/colourless²
- Number, category and kind of light source(s):
- Lamp approved for LED substitute light source(s): yes/no²
- If yes, category of LED substitute light source(s)
- Rated voltage or the range of voltage:
- Light source module: yes/no²
- Light source module specific identification code:
- Only for limited mounting height of equal to or less than 750 mm above the ground, if applicable: yes/no²
- Geometrical conditions of installation and relating variations, if any:
- Application of an electronic light source control gear/variable intensity control:
- (a) Being part of the lamp: yes/no²
- (b) Being not part of the lamp: yes/no²
- Input voltage(s) supplied by an electronic light source control gear/variable intensity control:
- Electronic light source control gear/variable intensity control manufacturer and identification number (when the light source control gear is part of the lamp but is not included into the lamp body):

-
- Variable luminous intensity, if applicable: yes/no²
- Function(s) produced by an interdependent lamp forming part of an interdependent lamp system, if applicable:
- 9.3. The front position lamp², rear position lamp², stop lamp², end-outline marker lamp², daytime running lamp², parking lamp² is only for use on a vehicle fitted with a tell-tale indicating failure: yes/no²
- 9.4. Whether an additional test is conducted according to the paragraph 4.8.3.1.1. of this Regulation: yes/no²
10. Position of the approval mark or Unique Identifier (UI):.....
11. Reason(s) for extension (if applicable):
-
12. Approval granted/extended/refused/withdrawn²:
13. Approval granted for devices to be used on vehicles already in use only, yes/no²
14. Place:
15. Date:
16. Signature:
17. The list of documents deposited with the Type Approval Authority which has granted approval is annexed to this communication and may be obtained on request.
-
-
-
-
-

Annex 2

Angles of geometric visibility

The angles shown in these arrangements are correct for lamps to be mounted on the right side of the vehicle.

Part A: Position, end-outline marker, stop, front and rear direction indicators, daytime running and front and rear parking lamps

Figures A2-I:

Angles of geometric visibility, horizontal and vertical

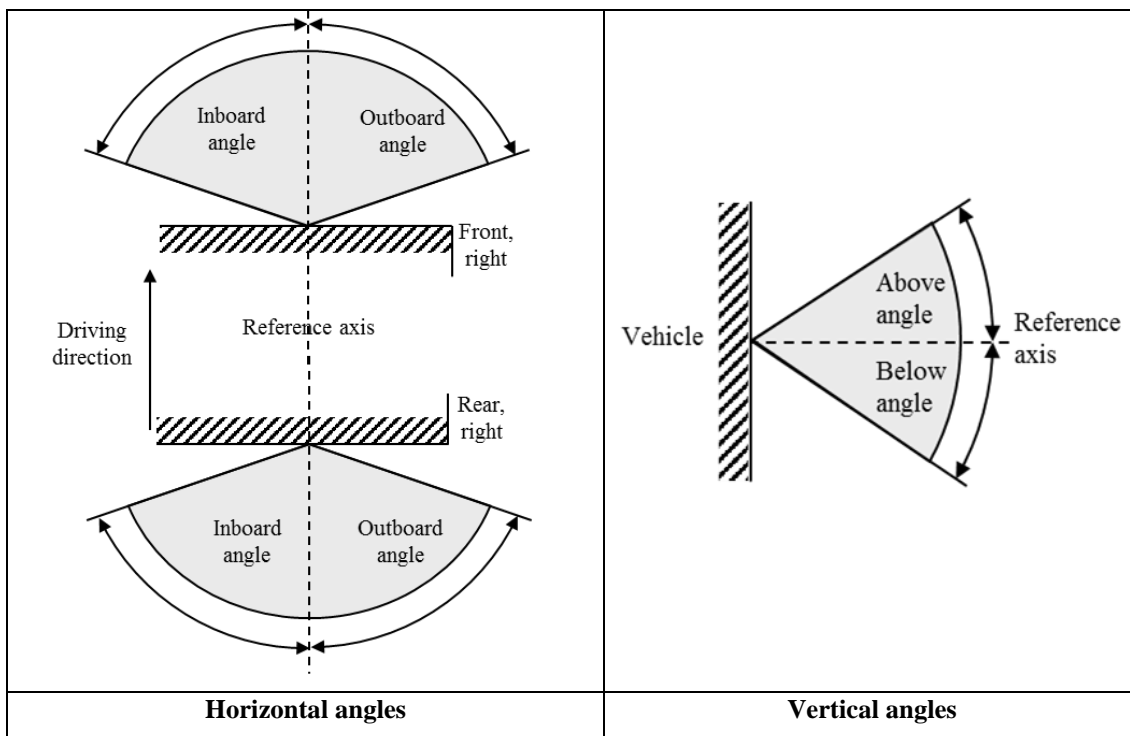

Table A2-1
Angles of geometric visibility, horizontal and vertical

<i>Lamp</i>	<i>Minimum horizontal angles (inboard / outboard)</i>	<i>Minimum vertical angles (above / below)</i>	<i>Additional information</i>
Front direction indicator (1, 1a, 1b)	45°/80° (20°/80°) ^a	15°/15° (15°/5°) ^b	-
Rear direction indicator (2a, 2b)	45°/80° (20°/80°) ^a	15°/15° (15°/5°) ^b (5°/15°) ^c	-
Front/rear direction indicator (11, 11a, 11b, 11c, 12)	20°/80°	15°/15° (15°/5°) ^b	-
Front/rear position singular (MA, MR)	80°/80°	15°/10° (15°/5°) ^b	-
Front/rear position pair (MA, MR)	20°/80°	15°/10° (15°/5°) ^b	-
Stop singular (MS)	45°/45°	15°/10° (15°/5°) ^b	-
Stop pair (MS)	0°/45°	15°/10° (15°/5°) ^b	-
Front/rear position (A, R1, R2)	45°/80° (20°/80°) ^a	15°/15° (15°/5°) ^b (5°/15°) ^c	-
Front/rear parking (77R)	0°/45°	15°/15° (15°/5°) ^b	-
Front/rear end-outline marker (AM, RM1, RM2)	0°/80°	15°/15° (15°/5°) ^b (5°/15°) ^c	-
Stop lamp (S1, S2)	45°/45° (20°/45°) ^a	15°/15° (15°/5°) ^b (5°/15°) ^c	-
High mounted stop lamp (S3, S4)	10°/10°	10° / 5°	-
Daytime running lamps (RL)	20°/20°	10° / 5°	-

Notes to Table A2-1:

^a Reduced angles used only below the H-plane for lamps mounted with the H-plane below 750 mm.

^b For lamps to be installed with the H-plane of the lamp at a mounting height of less than 750 mm.

^c Optional lamps to be installed with the H-plane of the lamp at a mounting height of more than 2,100 mm.

Part B: Side direction indicators and side parking lamps

Figures A2-II
Angles of geometric visibility, horizontal and vertical

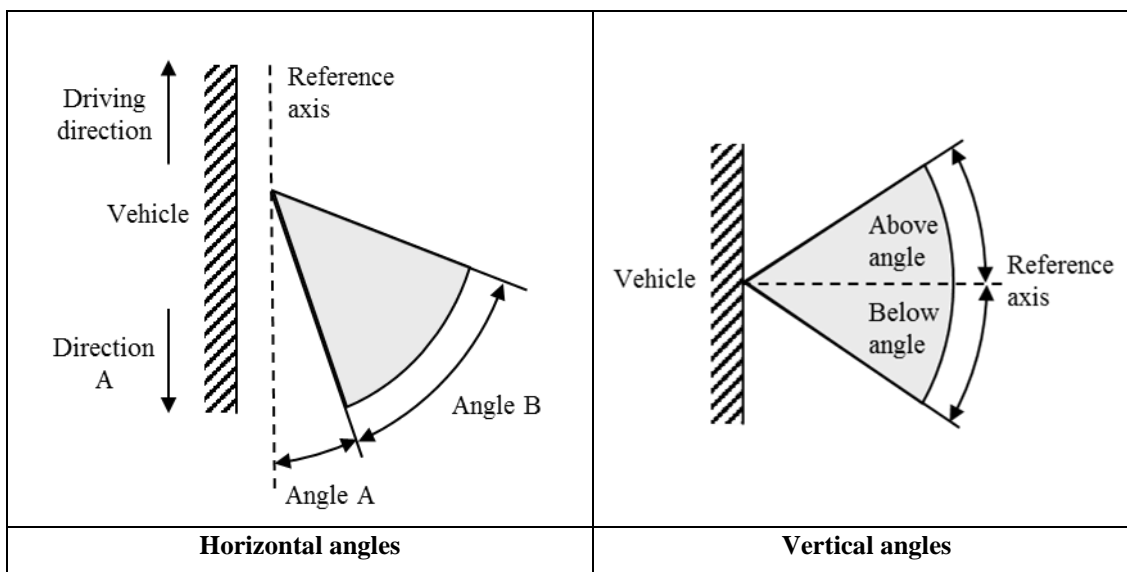

Table A2-2
Angles of geometric visibility, horizontal and vertical

<i>Lamp</i>	<i>Horizontal angles (A/B)</i>	<i>Min. vertical angles (above/below)</i>	<i>Additional information</i>
Side direction indicators (5)	5° / 55°	15° / 15° 15° / 5° ^b	Horizontal angles apply to direction A
Side parking ^a	0° / 45°	15° / 15° 15° / 5° ^b	Horizontal angles apply to front and rear

Notes to Table A2-2:

^a Side parking lamps are a combination of front and rear facing parking lamps

^b Reduced angles used for lamps mounted with the H-plane below 750 mm.

Part C: Side marker lamps

Figures A2-III
Angles of geometric visibility, horizontal and vertical

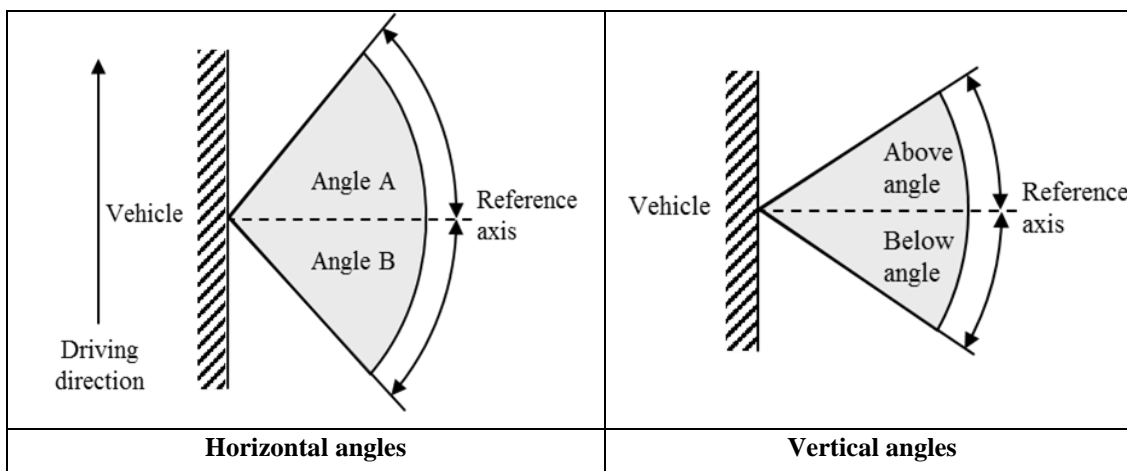

Table A2-3
Angles of geometric visibility, horizontal and vertical

<i>Lamp</i>	<i>Min. horizontal angles (A/B)</i>	<i>Min. vertical angles (above/below)</i>	<i>Additional information</i>
Side marker (SM1)	45° / 45°	10° / 10° 10° / 5° ^{oa}	
Side marker (SM2)	30° / 30°	10° / 10° 10° / 5° ^{oa}	

Notes to Table A2-3:

^a Reduced angles used for lamps mounted with the H-plane below 750 mm.

Part D: Rear-registration plate illuminating lamp, field of visibility

Figures A2-IV

Field of visibility, horizontal and vertical

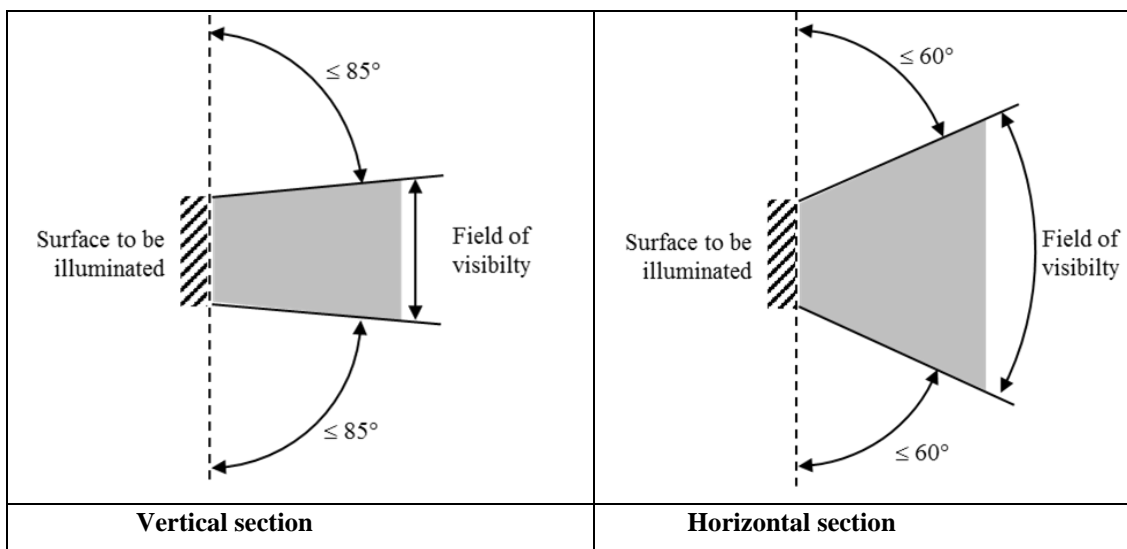

Table A2-4

Field of visibility, horizontal and vertical

- | |
|---|
| <ol style="list-style-type: none"> 1. The field-of-visibility angles shown above relate only to the relative positions of the rear registration plate illuminating lamp and the space for the registration plate. 2. The field of visibility of the registration plate when mounted on the vehicle remains subject to the relevant national regulations. 3. The angles shown take account of the partial occultation caused by the rear registration plate illuminating lamp. They must be adhered to in the directions in which there is most occultation. The rear registration plate illuminating lamp must be such as to reduce the areas partly occulted to the minimum strictly necessary. |
|---|

Annex 3

Standard light distributions

1. If not otherwise specified:
 - 1.1. The direction $H = 0^\circ$ and $V = 0^\circ$ corresponds to the reference axis. (On the vehicle, it is horizontal, parallel to the median longitudinal plane of the vehicle and oriented in the required direction of visibility.) It passes through the centre of reference. Unless specified otherwise, the values shown in Figures A3-I to A3-XV give, for the various directions of measurement, the minimum intensities as a percentage of the minimum intensities required.

However, in the case where one of the following lamps is intended to be installed at a mounting height (using the H plane specified by the manufacturer) equal to or less than 750 mm above the ground, the photometric intensity is verified only up to an angle of 5° downwards:

 - (a) Front and rear direction indicators lamps;
 - (b) Front and rear position lamps;
 - (c) Front and rear end-outline marker lamps;
 - (d) Parking lamps;
 - (e) Stop lamps of category S1, S2 and MS;
 - (f) Side marker lamps;
 - 1.2. Within the field of light distribution schematically shown as a grid, the light pattern should be substantially uniform, i.e. the light intensity in each direction of a part of the field formed by the grid lines shall meet at least the lowest minimum value being shown on the grid lines surrounding the questioned direction as a percentage.

However, in the case of reversing lamps, if visual examination of a lamp appears to reveal substantial local variations of intensity, a check shall be made to ensure that no intensity measured between two of the directions of measurement referred to above is below 50 per cent of the lower minimum intensity of the two prescribed for these directions of measurement.
2. Standard light distribution.
 - 2.1. Standard light distribution for front and rear position lamps, parking lamps, front and rear end-outline marker lamps, stop lamps (S1, S2 and MS) and direction indicator lamps of categories 1, 1a, 1b, 2a, 2b, 11, 11a, 11b, 11c, 12.

The values shown give, for the various directions of measurement, the minimum intensities as a percentage of the minimum intensities required (see Tables 3, 4, 5, 7 and 8).

Figure A3-I:
Standard light distribution for front and rear position-, parking-, end-outline marker-, stop- and direction indicator lamps

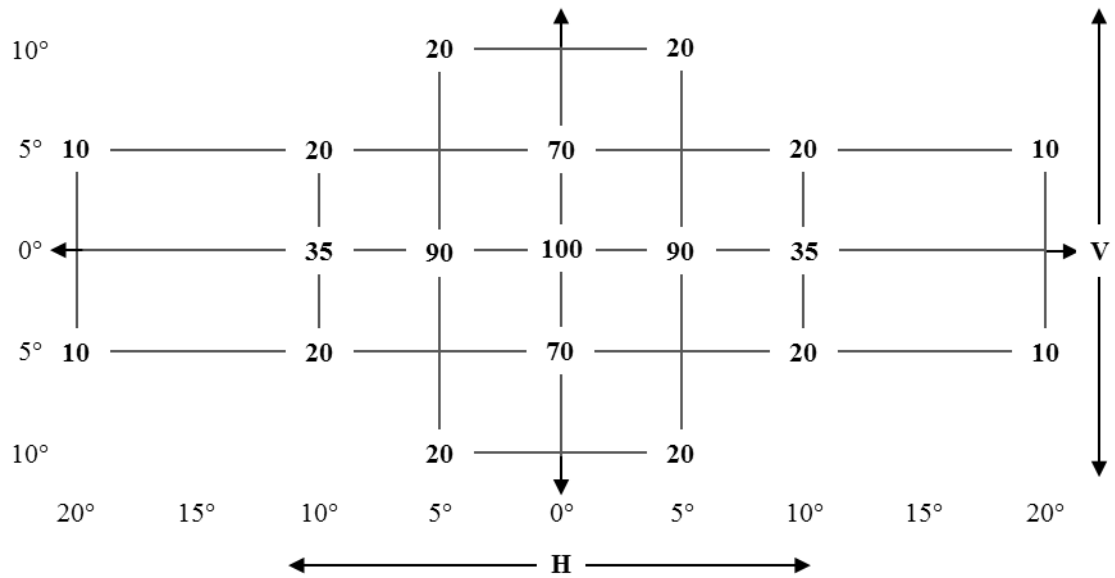

2.2. Standard light distribution for daytime running lamps

The values shown give, for the various directions of measurement, the minimum intensities as a percentage of the minimum intensity required (see Table 6).

Figure A3-II
Light distribution for daytime running lamps

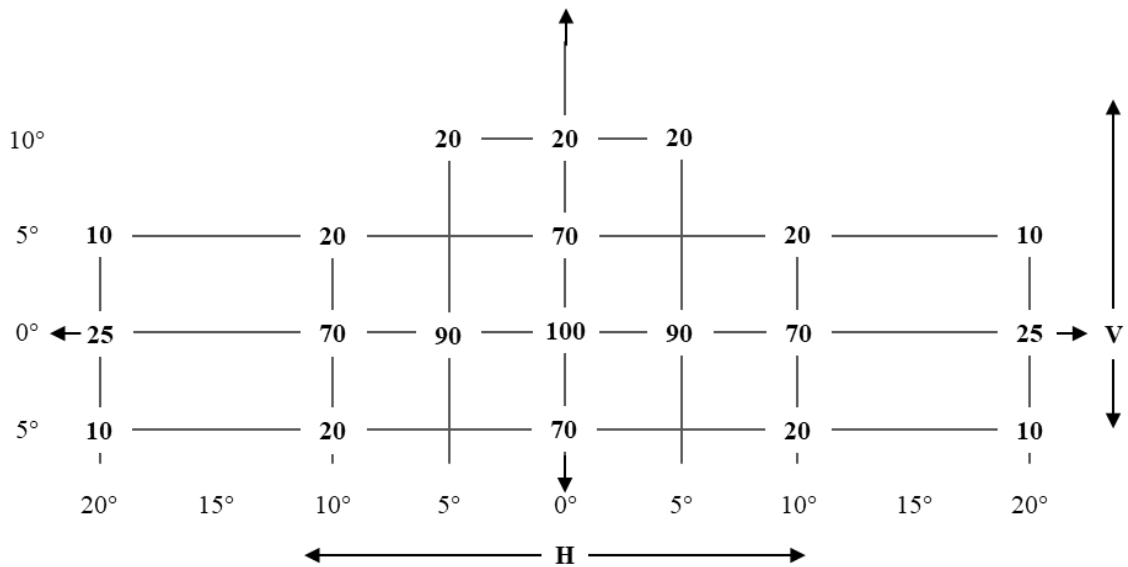

2.3. Standard light distribution for category S3 and S4 stop lamps

The values shown give, for the various directions of measurement, the minimum intensities as a percentage of the minimum intensities required (see Table 7).

Figure A3-III

Light distribution for S3 and S4 stop lamps

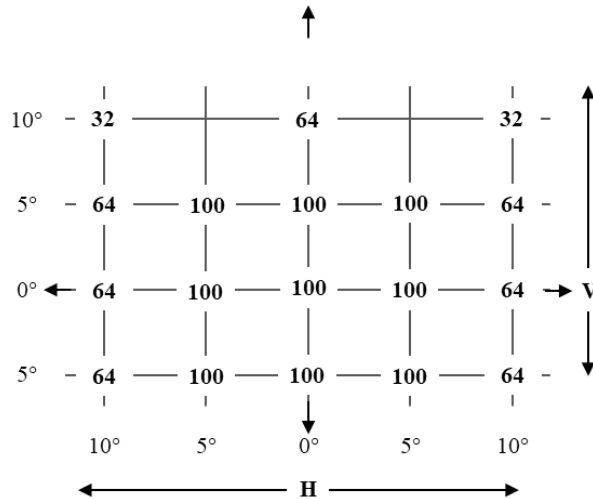

2.4. Standard light distribution for direction indicators lamps of category 6

The direction $H = 5^\circ$ and $V = 0^\circ$, corresponds to the minimum value prescribed in Table 8.

The values shown give, for the various directions of measurement, the minimum intensities as a percentage of the minimum intensity required (see Table 8).

Figure A3-IV

Light distribution for direction indicator lamps category 6

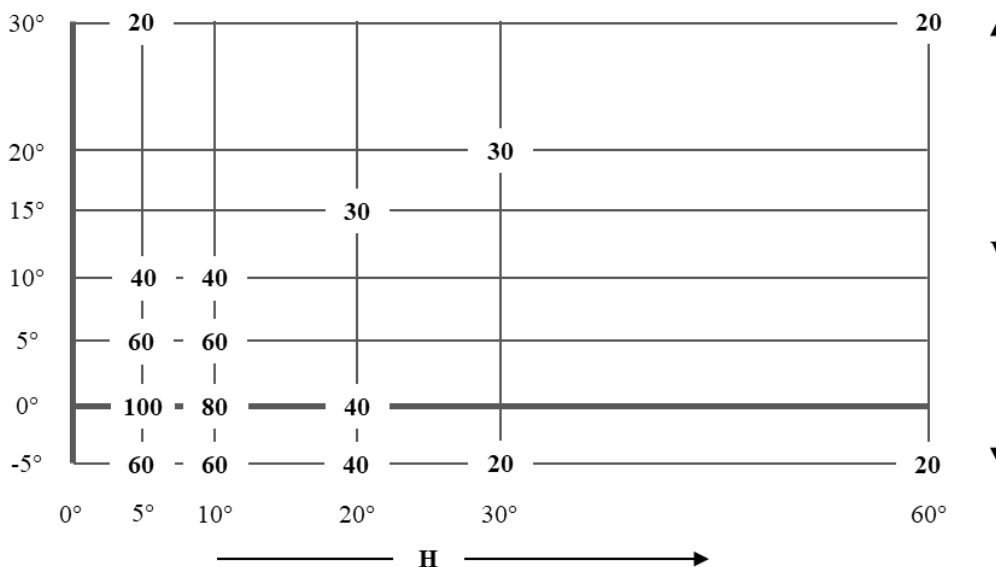

(outer side of the vehicle)

2.5. Standard light distribution for reversing lamps

The measuring points expressed in degrees of angle with the axis of reference and values of the minimum intensities of the light emitted.

Figure A3-V
Light distribution for reversing lamps

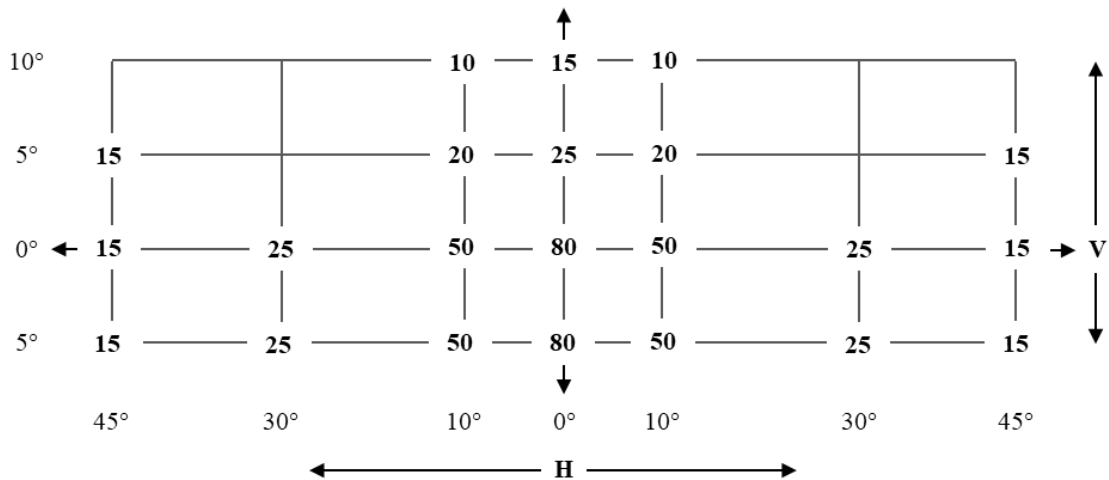

The values inside figure A3-V are in cd.

The directions $H = 0^\circ$ and $V = 0^\circ$ correspond to the axis of reference. On the vehicle they are horizontal, parallel to the median longitudinal plane of the vehicle and oriented in the required direction of visibility. They pass through the centre of reference. The values shown in figure A3-V give, for the various directions of measurement, the minimum intensities in cd.

2.6. Standard light distribution for rear fog lamps

Figure A3-VI
Light distribution for rear fog lamps

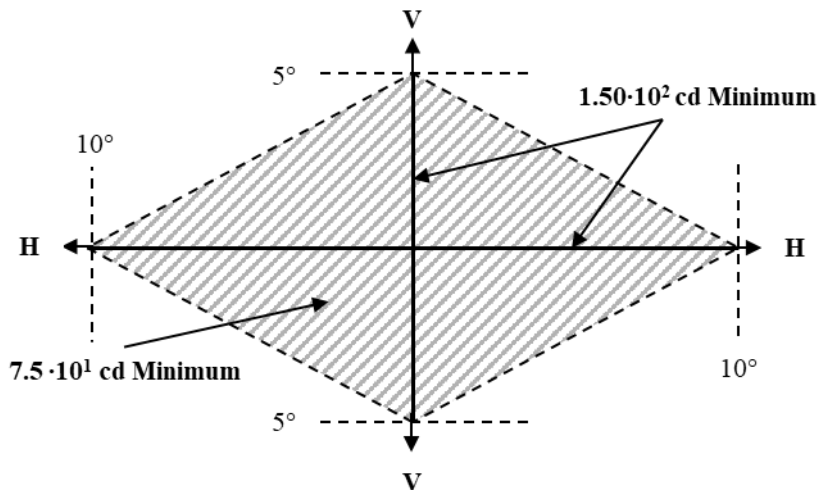

If visual examination of a light appears to reveal substantial local variations of intensity, a check shall be made to ensure that, outside the axes, no intensity measured within the rhombus defined by the extreme directions of measurement is below $7.5 \cdot 10^1$ cd (see figure A3-VI).

2.7. Standard light distribution for side marker lamps

2.7.1. SM1 category of side marker lamps

Figure A3-VII
Light distribution for side marker lamps SM1

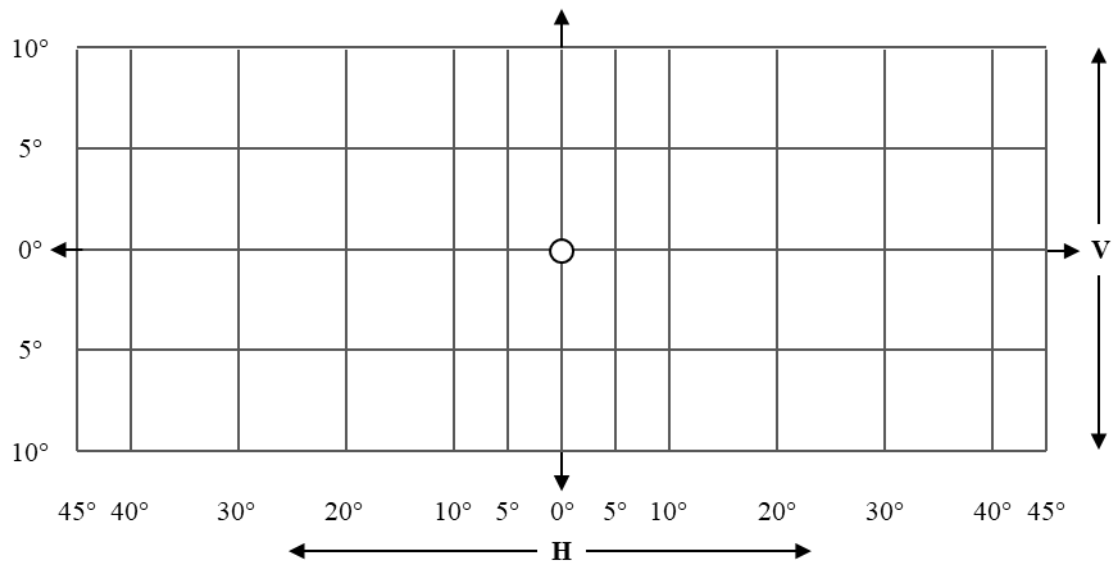

2.7.2. SM2 category of side marker lamps

Figure A3-VIII
Light distribution for side marker lamps SM2

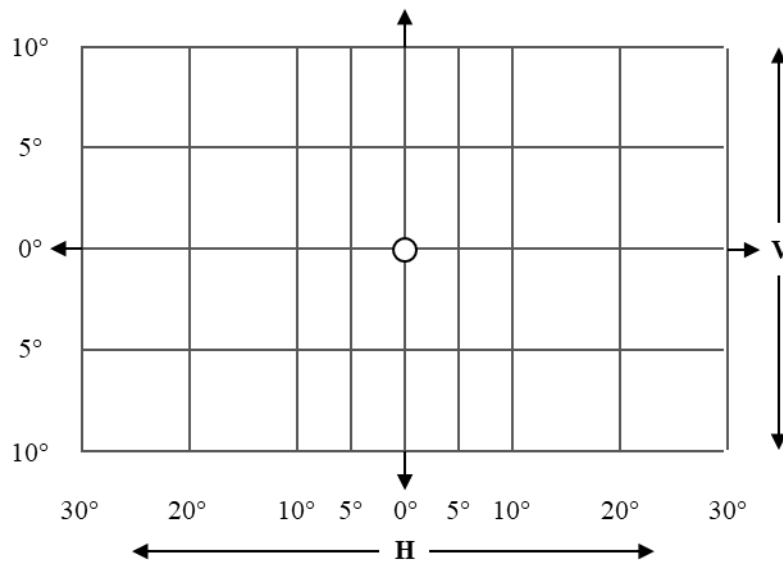

3. Measurement points for rear-registration plate illuminating lamps (see paragraph 5.11.3.)

3.1. Category 1a - tall plate (340 x 240 mm)

Figure A3-IX
Measuring points for plate size 340 x 240 mm

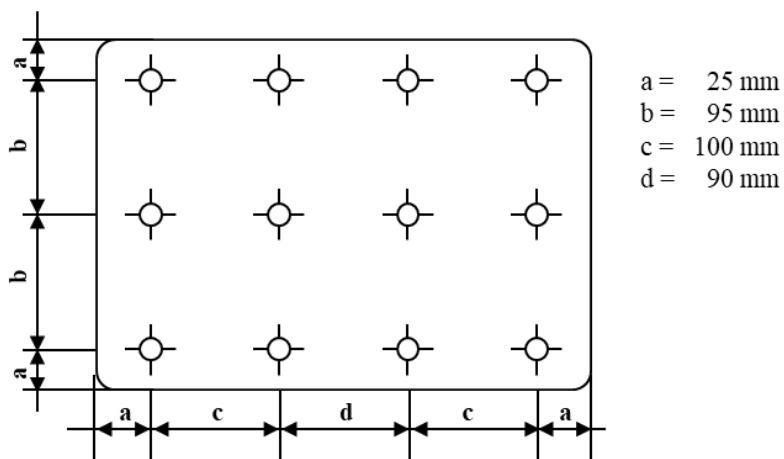

3.2. Category 1b - wide plate (520 x 120 mm)

Figure A3-X
Measuring points for plate size 520 x 120 mm

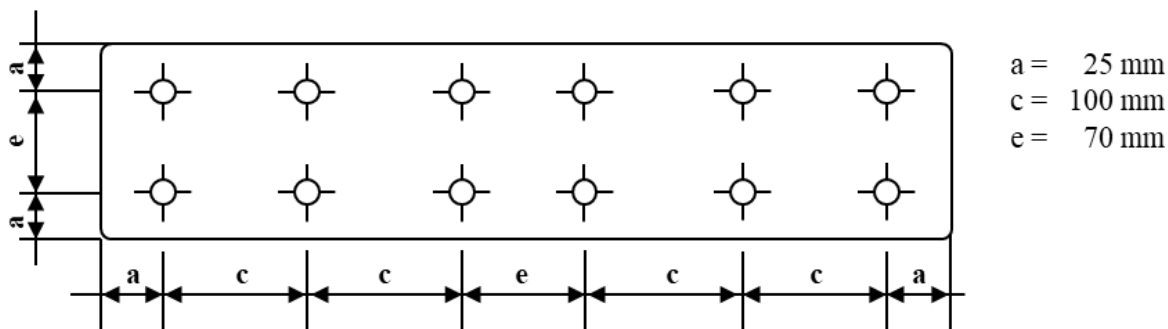

3.3. Category 1c - plate for agricultural or forestry tractors (255 x 165 mm)

Figure A3-XI
Measuring points for plate size 255 x 165 mm

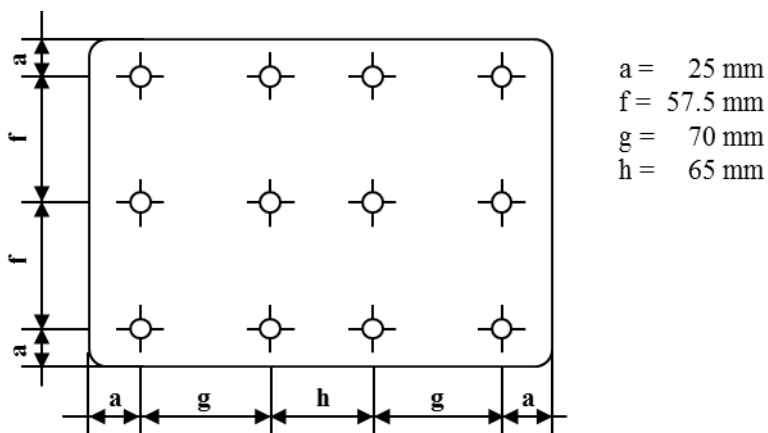

3.4. Category 2a - small plate (330 x 165 mm)

Figure A3-XII
Measuring points for plate size 330 x 165 mm

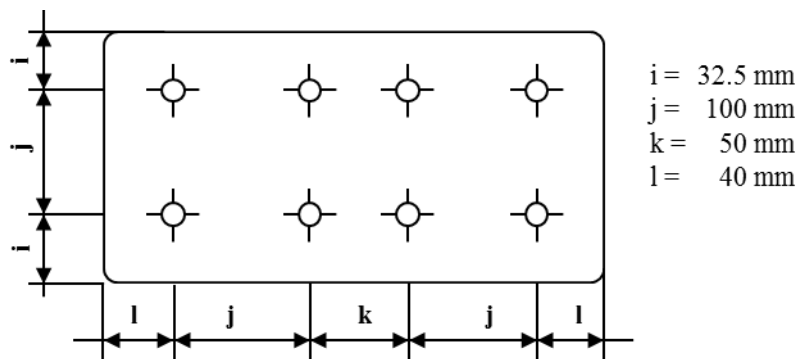

3.5. Category 2b – wide plate (440 x 220 mm)

Figure A3-XIII
Measuring points for plate size 440 x 220 mm

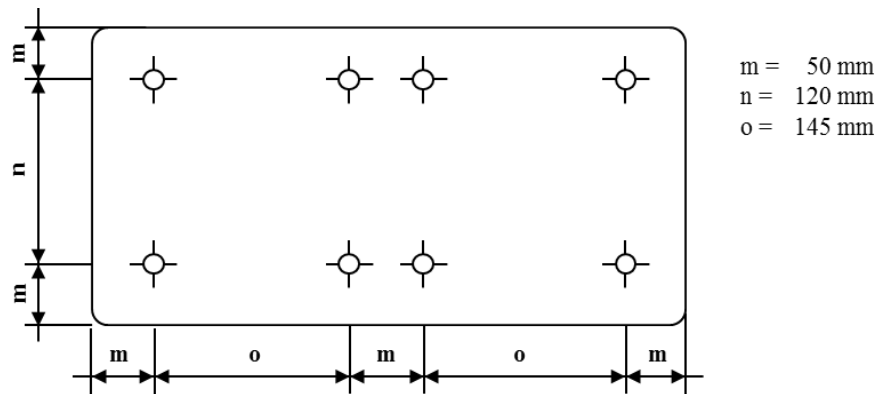

Note: In the case of devices for illuminating two or all of the plates, the measurement points used are obtained by combining the corresponding drawings above in accordance with the outline indicated by the make or manufacturer; however, if two measurement points are less than 30 mm apart, only one shall be used.

3.6. Category 1 (240 x 130 mm) for vehicles of category L

Figure A3-XIV
Measuring points for plate size 240 x 130 mm

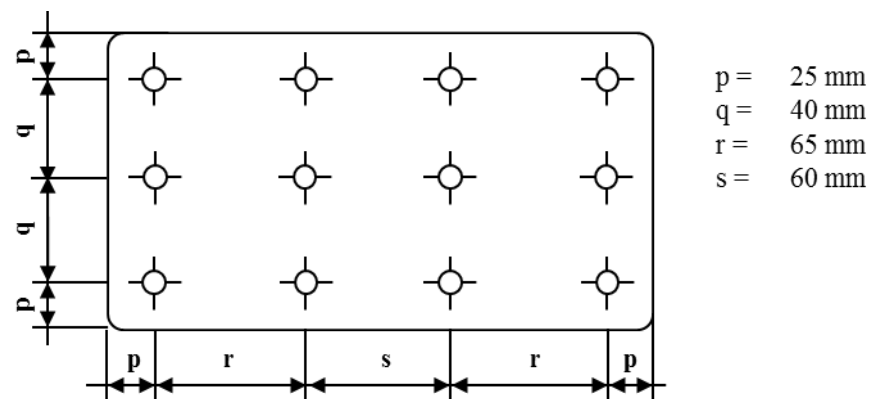

3.7. Category 2 (280 x 200 mm) for vehicles of category L

Figure A3-XV
Measuring points for plate size 280 x 200 mm

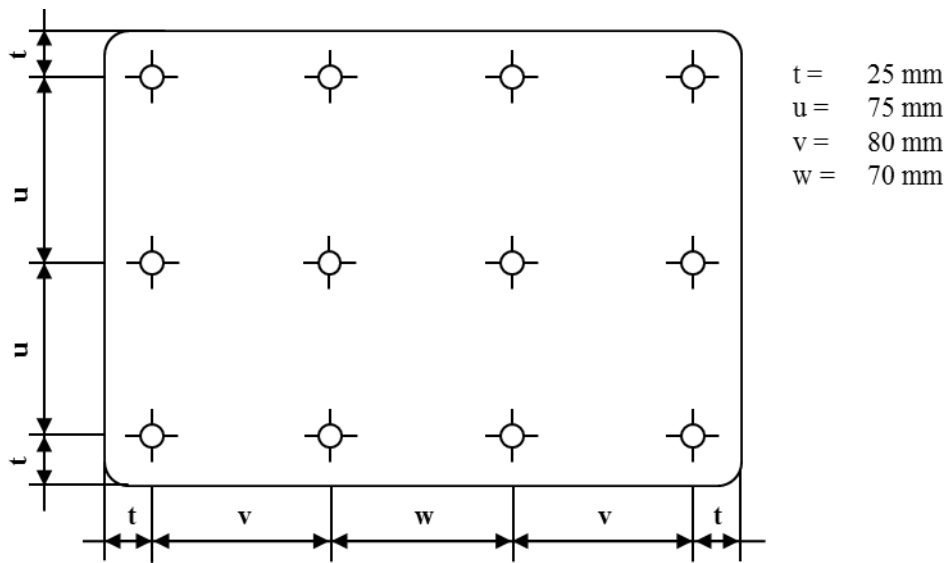

Annex 4

Minimum requirements for conformity of production control procedures

1. General
 - 1.1. The conformity requirements shall be considered satisfied from a mechanical and geometric standpoint, if the differences do not exceed inevitable manufacturing deviations within the requirements of this Regulation.
 - 1.2. With respect to photometric performances, the conformity of mass-produced lamps shall not be contested, when testing photometric performances of any lamp chosen at random according to paragraph 4.8. of this Regulation.
 - 1.2.1. If, in the case of a lamp equipped with a replaceable light source and if results of the test described above do not meet the requirements, tests on lamps shall be repeated using another standard light source.
 - 1.3. The chromaticity coordinates shall be complied with when tested under conditions of paragraph 4.9. of this Regulation.
 - 1.4. In the case of non-replaceable filament light source(s) or light source module(s) equipped with non-replaceable filament light source, at any conformity of production check:
 - 1.4.1. the holder of the type approval shall demonstrate the use in normal production and show the identification of the non-replaceable filament light source(s) as indicated in the type approval documentation;
2. Minimum requirements for verification of conformity by the manufacturer

For each type of lamp, the holder of the type approval shall carry out at least the following tests, at appropriate intervals. The tests shall be carried out in accordance with the provisions of this Regulation.

If any sampling shows non-conformity with regard to the type of test concerned, further samples shall be taken and tested. The manufacturer shall take steps to ensure the conformity of the production concerned.

 - 2.1. Nature of tests

Tests of conformity in this Regulation shall cover the photometric and colorimetric characteristics.
 - 2.2. Methods used in tests
 - 2.2.1. Tests shall generally be carried out in accordance with the methods set out in this Regulation.
 - 2.2.2. In any test of conformity carried out by the manufacturer, equivalent methods may be used with the consent of the competent authority responsible for approval tests. The manufacturer is responsible for proving that the applied methods are equivalent to those laid down in this Regulation.
 - 2.2.3. The application of paragraphs 2.2.1. and 2.2.2. requires regular calibration of test apparatus and its correlation with measurements made by a competent authority.
 - 2.2.4. In all cases the reference methods shall be those of this Regulation, particularly for the purpose of administrative verification and sampling.
 - 2.3. Nature of sampling

Samples of lamps shall be selected at random from the production of a uniform batch. A uniform batch means a set of lamps of the same type, defined according to the production methods of the manufacturer.

The assessment shall in general cover series production from individual factories. However, a manufacturer may group together records concerning the same type from several factories, provided these operate under the same quality system and quality management.

2.4. Measured and recorded photometric and colorimetric characteristics

The sampled lamp shall be subjected to photometric measurements for the minimum values at the points listed in Annex 3. and the required chromaticity coordinates.

2.5. Criteria governing acceptability

The manufacturer is responsible for carrying out a statistical study of the test results and for defining, in agreement with the competent authority, criteria governing the acceptability of his products in order to meet the requirements laid down for verification of conformity of products in paragraph 6.1. of this Regulation.

The criteria governing the acceptability shall be such that, with a confidence level of 95 per cent, the minimum probability of passing a spot check in accordance with Annex 5 would be 0.95.

Annex 5

Minimum requirements for sampling by an inspector

1. General provisions
 - 1.1. The conformity requirements shall be considered satisfied from a mechanical and a geometric standpoint, in accordance with the requirements of this Regulation, if any, if the differences do not exceed inevitable manufacturing deviations.
 - 1.2. With respect to photometric performance, the conformity of mass-produced lamps shall not be contested if, when testing the photometric performances set forth in paragraph 4.8. of this Regulation of any lamp chosen at random:
 - (a) No measured value deviates from the values prescribed in paragraph 6.1.3. of this Regulation.
 - (b) If, in the case of a lamp equipped with a replaceable light source and if results of the test described above do not meet the requirements, tests on lamps shall be repeated using another standard light source.
 - 1.3. Lamps with apparent defects are disregarded.
 - 1.4. The chromaticity coordinates shall be complied when tested under conditions of paragraph 4.9. of this Regulation.
2. First sampling

Four lamps are selected at random. The first sample of two is marked A, the second sample of two is marked B.

 - 2.1. The conformity of mass-produced lamps shall not be contested if the deviation of any specimen of samples A and B (all four lamps) is not more than 20 per cent.

In the case, that the deviation of both lamps of sample A is not more than 0 per cent the measurement can be terminated.
 - 2.2. The conformity of mass-produced lamps shall be contested if the deviation of at least one specimen of samples A or B is more than 20 per cent.

The manufacturer shall be requested to bring its production in line with the requirements (alignment) and a repeated sampling according to paragraph 3 shall be carried out within two months' time after the notification. The samples A and B shall be retained by the Technical Service until the entire CoP process is finished.
3. First repeated sampling

A sample of four lamps is selected at random from stock manufactured after alignment. The first sample of two is marked C, the second sample of two is marked D.

 - 3.1. The conformity of mass-produced lamps shall not be contested if the deviation of any specimen of samples C and D (all four lamps) is not more than 20 per cent.

In the case, that the deviation of both lamps of sample C is not more than 0 per cent the measurement can be terminated.
 - 3.2. The conformity of mass-produced lamps shall be contested if the deviation of at least one specimen of samples C or D is:
 - 3.2.1. More than 20 per cent but the deviation of all specimens of these samples is not more than 30 per cent.

The manufacturer shall be requested again to bring its production in line with the requirements (alignment).

A second repeated sampling according to paragraph 4 shall be carried out within two months' time after the notification. The samples C and D shall be retained by the Technical Service until the entire COP process is finished.

3.2.2. One specimen of samples C or D is more than 30 per cent. In this case the approval shall be withdrawn and paragraph 5 shall be applied.

4. Second repeated sampling

A sample of four lamps is selected at random from stock manufactured after alignment. The first sample of two is marked E, the second sample of two is marked F.

4.1. The conformity of mass-produced lamps shall not be contested if the deviation of any specimen of samples E and F (all four lamps) is not more than 20 per cent. In the case, that the deviation of both lamps of sample E is not more than 0 per cent the measurement can be terminated.

4.2. The conformity of mass-produced lamps shall be contested if the deviation of at least one specimen of samples E or F is more than 20 per cent. In this case the approval shall be withdrawn and paragraph 5 shall be applied.

5. Approval withdrawn

As required according to paragraphs 4.1. and 4.2., approval shall be withdrawn according to paragraph 3.6. of this Regulation.

Annex 6

Heat resistance test for rear fog lamps and daytime running lamps

1. The lamp shall be subjected to a one-hour test of continuous operation following a warm-up period of 20 minutes. The ambient temperature shall be $23\text{ °C} \pm 5\text{ °C}$. The light source used shall be a light source of the category specified for the lamp and shall be supplied with a current at a voltage such that it gives the specified average power at the corresponding test voltage. However, for lamps equipped with non-replaceable light sources (filament light sources and other), the test shall be made with the light sources present in the lamp, in accordance with paragraph 5.4.5. of this Regulation.
2. Where only the maximum power is specified, the test shall be carried out by regulating the voltage to obtain a power equal to 90 per cent of the specified power. The specified average or maximum power referred to above shall in all cases be chosen from the rated voltage(s) of 6, 12 or 24 V at which it reaches the highest value; for lamps equipped with non-replaceable light sources the test conditions set in paragraph 5.4.5. or 5.9.5. of this Regulation shall be applied.
 - 2.1. In the case of light sources operated by an electronic control gear to obtain variable luminous intensity, the test shall be carried out under the conditions given at minimum 90 per cent of the higher luminous intensity.
3. After the lamp has been stabilized at the ambient temperature, no distortion, deformation, cracking or colour modification shall be perceptible. In case of doubt the intensity of light shall be measured according to paragraph 5. of this Regulation. At that measurement the values shall reach at least 90 per cent of the values obtained before the heat resistance test on the same lamp.

Annex 7

Arrangement of approval markings

The following approval marking arrangements are given merely as examples and any other arrangement made in accordance with paragraph 3.3. of this Regulation is acceptable.

1. Approval marking of a single light signalling lamp

Figure A7-I - Marking example 1

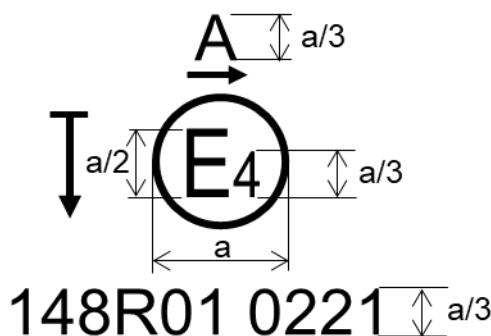

a = see Par. 3.3.1.2.1. of this Regulation

The lamp bearing the approval marking shown on the left is a front position lamp (A) approved in the Netherlands (E4), under approval number 0221 pursuant to this Regulation (148R).

The number (01) mentioned after 148R indicates that approval was granted in accordance with the requirements of this Regulation as set in the 01 series of amendments. The horizontal arrow indicates the outwards of the vehicle. The vertical arrow starting from a horizontal segment and directed downwards indicates a lamp with reduced light distribution (vertically downwards and/or horizontally below the H plane).

Figure A7-II - Marking example 2

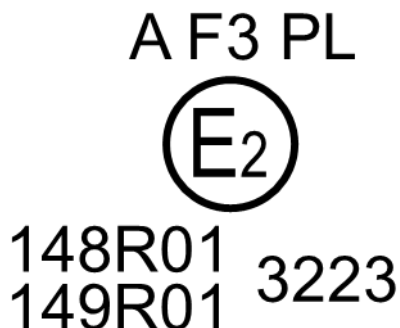

The lamp bearing the approval marking shown on the left is a combination of a front position lamp (A) and a front fog lamp (F3) with a plastic lens (PL) approved in France (E2), under approval number 3223 pursuant to this Regulation (148R) and the UN Regulation for Road Illumination Devices (149R).

The number (01) mentioned after 148R and after 149R indicates that approval was granted in accordance with the requirements of the pertinent Regulation as set in the 01 series of amendments.

2. Approval marking of grouped, combined or reciprocally incorporated lamps

Note: The vertical and horizontal lines schematize the shape of the light-signalling lamp. These lines are not part of the approval marking.

Figure A7-III
Marking example 3-a

	3333 Ⓔ 148R01 150R01	IA	<u>2b</u>	<u>R2</u>
		F2	AR	S2

Marking example 3-b

IA <u>2b</u> <u>R2</u> F2 AR S2 3333 Ⓔ 148R01 150R01			

These examples of approval markings represent two possible solutions for the marking of a light signalling lamp where two or more lamps are part of the same assembly of grouped, combined or reciprocally incorporated lamps

They indicate that the lamp was approved in the Netherlands (E4) under approval number 3333 and comprises:

- (a) A retro-reflector of class IA;
- (b) A rear direction indicator lamp with variable luminous intensity (category 2b). The horizontal arrow shows in what position this device, which cannot be mounted on either side of the vehicle indiscriminately, is to be mounted;
- (c) A rear position lamp with variable luminous intensity (R2). The horizontal arrow indicates the side on which the required photometric specifications are met up to an angle of 80° H;
- (d) A rear fog lamp with variable luminous intensity (F2);
- (e) A reversing lamp (AR);
- (f) A stop lamp with variable luminous intensity (S2).

The number (01) mentioned after 148R and after 150R indicates that all these lamps (functions) are approved in accordance with the requirements of the pertinent Regulation as set in the 01 series of amendments.

3. Approval marking of a lamp where the lens is intended to be used in different types of lamps

Figure A7-IV - Marking example 4

F1 2a AR R1 S1



148R01 1432

This example corresponds to the marking of a lens intended to be used in different types of light signalling lamps, see paragraph 3.3.5.4. of this Regulation. The approval markings indicate that the lamp was approved in Spain (E9) under approval number 1432 and may comprise all listed different functions.

4. Identification code of light source modules

Figure A7-V - Marking example 5

Light source module marking

MD E3 17325

The light source module bearing the identification code shown above has been approved together with a lamp approved in Italy (E3) under approval number 17325.

Annex 8

Testing procedures with respect to light sources

1. General test requirements
 - 1.1. For lamps (functions) using incandescent technology only, the luminous intensities measured after photometric stability shall comply with the minimum and maximum requirements.
 - 1.2. For lamps (functions) using light source technologies other than incandescent technology only:
 - 1.2.1. For reversing lamps and manoeuvring lamps, the luminous intensities measured after 1 minute and after 10 minutes of operation, shall comply with the minimum and maximum requirements. The luminous intensity distribution after 1 and after 10 minutes of operation may be calculated from the luminous intensity distribution measured after photometric stability has occurred by applying at each test point the ratio of luminous intensities measured at HV:
 - (a) After 1 minute;
 - (b) After 10 minutes; and
 - (c) After photometric stability has occurred.
 - 1.2.2. For all other lamps, the luminous intensities measured after 1 min and after 30 minutes of operation shall comply with the minimum and maximum requirements.

Operation of direction indicator lamps shall be done in flashing mode ($f = 1.5$ Hz, duty factor 50 per cent).

The luminous intensity distribution after 1 min of operation may be calculated from the luminous intensity distribution after 30 min of operation by applying at each test point the ratio of luminous intensities measured at HV after 1 min and after 30 min of operation.

2. Additional test requirements
 - 2.1. Depending on the light source technology, the luminous intensity distribution is, in addition to paragraph 1, checked for compliance at the point in time listed in Table A8-1.

The luminous intensity distributions at a point in time may be calculated from the luminous intensity distribution measured according to paragraph 1 by applying at each test point the ratio of luminous intensities measured at the reference coordinate of the lamp (function) under consideration.

Table A8-1

Points in time for additional testing

<i>Lamp (function)</i>	<i>Time after switch ON (seconds)</i>	<i>Reference coordinate</i>
Rear-registration plate illumination	4	any measurement point given in Annex 3
Direction Indicator Cat 1, 2, 11, 12	0.2	HV
Direction Indicator Cat 5, 6	0.2	H5, V0
Front and rear position	4	HV
Stop	0.2	HV
End-outline marker	4	HV
Reversing	0.2	HV

Manoeuvring	N.A.	N.A.
Rear fog	4	HV
Parking	4	HV
Daytime running	4	HV
Side marker	4	HV

- 2.1.1. In case a lamp (function) uses incandescent technology only, a lamp (function) is deemed to comply with the corresponding intensity requirements at all points in time, if the values measured according to paragraph 1.1. are compliant.
- 2.1.2. In case a lamp (function) uses LED technology only, a lamp (function) is deemed to comply with the corresponding intensity requirements at all points in time, if the values measured according to paragraph 1.2. are compliant.
- 2.1.3. In case a lamp (function) uses any other light generating technology, the corresponding intensity requirements of a lamp (function) are tested and checked for compliance at the corresponding point in time listed in Table A8-1 and ending when photometric stability is reached.
- 2.1.4. In case a lamp (function) uses more than one light generating technology, the corresponding intensity requirements of a lamp (function) are tested following the strictest time requirements according to paragraphs 2.1.1. to 2.1.3. for the combination of them and checked for compliance.
- 2.1.5. In case of doubt (e.g. unexpected run-up behaviour), the corresponding minimum intensity requirements of a lamp (function) are tested and checked for compliance at all points in time starting at the corresponding point in time listed in Table A8-1 and ending when photometric stability is reached.
-