



Economic and Social Council

Distr.: General
11 April 2022

Original: English

Economic Commission for Europe

Inland Transport Committee

World Forum for Harmonization of Vehicle Regulations

187th session

Geneva, 21-24 June 2022

Item 4.14.6 of the provisional agenda

1958 Agreement:

Pending proposals for amendments to existing UN Regulations submitted by GRE and GRSG

Proposal for the 01 series of amendments to UN Regulation No. 150 (Retro-reflective devices)

Submitted by the Working Party on Lighting and Light-Signalling*

The text reproduced below was adopted by the Working Party on Lighting and Light-Signalling (GRE) at its eighty-third session (ECE/TRANS/WP.29/GRE/85, para. 15). It is based on ECE/TRANS/WP.29/GRE/2021/15, as amended by informal document GRE-85-15 and contains further editorial corrections. It is submitted to the World Forum for Harmonization of Vehicle Regulations (WP.29) and to the Administrative Committee (AC.1) for consideration at their June 2022 sessions.

* In accordance with the programme of work of the Inland Transport Committee for 2022 as outlined in proposed programme budget for 2022 (A/76/6 (part V sect. 20) para 20.76), the World Forum will develop, harmonize and update UN Regulations in order to enhance the performance of vehicles. The present document is submitted in conformity with that mandate.



UN Regulation No.150, amend to read:

"UN Regulation on uniform provisions concerning the approval of retro-reflective devices and markings for power-driven vehicles and their trailers

Contents

	<i>Page</i>
Regulation	
1. Scope	4
2. Definitions.....	4
3. Administrative provisions	6
4. General requirements	13
5. Specific technical requirements.....	15
6. Transitional provisions.....	26
Annexes	
1 Communication.....	28
2 Minimum requirements for conformity of production control procedures.....	30
3 Minimum requirements for sampling by an inspector.....	32
4 Photometric and colorimetric measurements	34
Part 1: Photometric measurements of retro-reflective devices	34
Part 2: Description of the measurement geometry for measurement of the daytime colour and the luminance factor of retro-reflective material	38
Part 3: Stability of photometric properties	39
5 Specifications of shape and dimensions	40
6 Environmental Testing	49
Part 1: Resistance to heat	49
Part 2: Resistance to water penetration for retro-reflective devices	49
Part 3: Alternative test procedures of resistance to water penetration for retro-reflective devices of the Classes IB and IIIB	50
Part 4: Resistance to corrosion	52
Part 5: Resistance of the accessible rear face of mirror-backed retro-reflective devices.....	52
Part 6: Resistance to weathering.....	53
7 Chemical testing	55
Part 1: Resistance to fuels.....	55
Part 2: Resistance to lubricating oils	55
8 Mechanical Testing	56
Part 1: Resistance to cleaning in the case of a sample unit of retro-reflective marking materials....	56
Part 2: Bonding strength in the case of adhesive materials	56
Part 3: Flexing - Retro-reflecting Marking Materials.....	56
Part 4: Resistance to impact	57

Part 5: Rigidity of retro-reflective marking plates.....	57
9 Further test procedures for Advance Warning Triangles of Type 1 and 2	58
10 Arrangement of approval markings.....	61
11 Guidelines for installation of rear marking plates on slow-moving vehicles (by construction) and their trailers	64

Introduction (for information)

This Regulation combines the provisions of individual UN Regulations Nos. 3, 27, 69, 70 and 104 into a single UN Regulation, and is the outcome of the World Forum for Harmonization of Vehicle Regulations (WP.29) decision to simplify the lighting and light-signalling Regulations based on the initial proposal by the European Union and Japan.

The objective of this Regulation is to increase the clarity, to consolidate and streamline the complexity of requirements in UN Regulations Nos. 3, 27, 69, 70 and 104 and to prepare for the future transition to performance-based requirements, by reducing the number of UN Regulations through an editorial exercise without changing any of the detailed technical requirements already in force up to the date of entry into force of this Regulation. This is reflected by the introduction of the original series of amendments to UN Regulation No. 150 and completes one of the objectives of the Working Party on Light and Light-Signalling (GRE) Informal Working Group “Simplification of Lighting and Light-Signalling Regulations” (IWG SLR).

With the introduction of the 01 series of amendments to this Regulation another objective of GRE IWG SLR comes into existence. This new series of amendments deals with the identified amendments and clarifications to this Regulation in order to achieve, to the current maximum possible extent, the goal of being technologically neutral, performance based and able to be tested objectively. This is accompanied by amendments to UN Regulations regarding the installation of lighting and light-signalling devices (Nos. 48, 53, 74 and 86) to reflect any necessary changes influenced by this Regulation.

1. Scope

This Regulation applies to retro-reflective devices as:

- Retro-reflectors of the Classes IA, IB, IIIA, IIIB and IVA
- Retro-reflective Marking Materials of the Classes C, D, E and F, D/E
- Retro-reflective Marking Plates for Heavy and Long Vehicles (HLV) of the Classes 1, 2, 3, 4 and 5
- Retro-reflective Marking Plates for Slow Moving Vehicles (SMV) of the Classes 1 and 2
- Advance Warning Triangles (AWT) of Type 1 and 2.

2. Definitions

For the purposes of this Regulation:

- 2.1. All the definitions given in the latest series of amendments to UN Regulation No. 48 in force at the time of application for type approval shall apply, unless otherwise specified in this UN Regulation or in the pertinent installation UN Regulations Nos. 53, 74 and 86.
- 2.1.1. "*Retro-reflective devices of different types*" means retro-reflective devices, as retro-reflectors or retro-reflective marking materials or marking plates or advance warning triangles of different types, which differ in such essential respects as:
- (a) The trade name or mark:
 - (i) Retro-reflective devices bearing the same trade name or mark but produced by different manufacturers are considered as being of different types;

- (ii) Retro-reflective devices produced by the same manufacturer differing only by the trade name or mark are considered as being of the same type;
- (b) The characteristics of the retro-reflective material;
- (c) The characteristics of the fluorescent material, if applicable;
- (d) The parts affecting the properties of the retro-reflective materials and/or plates;
- (e) The distinctive geometrical and mechanical features of the design (only for plates/devices corresponding to the Annex 5).

For materials and/or plates corresponding to the Annex 5, differences in the shape and dimensions of the marking shall not constitute a different type.

2.1.2. In the case of a type of "*retro-reflective device*" differing only by the trade name or mark from a type that has already been approved it shall be sufficient to submit:

- (a) A declaration by the "*retro-reflective device*" manufacturer that the type submitted is identical with (except in the trade name or mark) and has been produced by the same manufacturer as the type already approved, the latter being identified by its approval number;
- (b) Two samples bearing the new trade name or mark or equivalent documentation.

2.2. A type of "*retro-reflective device*" is defined by the models and descriptive literature submitted with the application for approval. Retro-reflective devices can be considered as belonging to the same type if they have one or more "*retro-reflecting optical units*" which are identical with those of the standard model, or if not identical are symmetrical and suitable for mounting one on the left and one on the right side of the vehicle, and if their other parts differ from those of the standard model only in ways not affecting the properties to which this Regulation applies. A change of colour of the retro-reflective marking material of the Classes D and E does not constitute a change of type.

2.3. Definitions CIE-Goniometer System

2.3.1. Geometric definitions are described in detail in Part 1 of Annex 4.

2.3.1.1. "*Illumination axis (symbol I)*" means a line segment from the centre of reference to the light source.

2.3.1.2. "*Observation axis (symbol O)*" means a line segment from the centre of reference to the photometer head;

2.3.1.3. "*Observation angle (symbol α)*" means the angle between the illumination axis and the observation axis. The observation angle is always positive and, in the case of retro-reflection, is restricted to small angles;

2.3.1.4. "*Observation on half-plane*" means the half-plane which originates on the illumination axis and which contains the observation axis;

2.3.1.5. "*Reference axis (symbol R)*" means a designated line segment originating on the centre of reference which is used to describe the angular position of the retro-reflective device;

2.3.1.6. "*Entrance angle*" means the angle between the illumination axis and the reference axis. The entrance angle consists of a vertical component (symbol β_1) and a horizontal component (symbol β_2).

For any direction the vertical angle β_1 is always given first.

NOTE 1 These angles are usually not larger than 90° but, for completeness, the full range is defined as

$$-90^\circ < \beta_1 < 90^\circ \text{ and} \\ -180^\circ < \beta_2 < 180^\circ.$$

NOTE 2 The entrance angle is sometimes as well referred to as illumination angle.

2.3.1.7. "Angle of *Rotation (symbol ε)*" means the angle by which the retroreflecting device is rotated about its axis of reference starting from a given position. If retro-reflective materials or devices have a marking (e.g. TOP), this marking defines $\varepsilon = 0^\circ$. The angle of rotation ε ranges from $-180^\circ < \varepsilon < +180^\circ$.

2.3.1.8. "*First axis (symbol 1)*" means an axis through the centre of reference and perpendicular to the observation half-plane;

2.3.1.9. "*Second axis (symbol 2)*" means an axis through the centre of reference and perpendicular to both the first axis and the reference axis. The positive direction of the second axis lies in the observation half-plane when $-90^\circ < \beta_1 < 90^\circ$ as shown in Part 1 of Annex 4.

2.3.2. Definition of photometric terms

2.3.2.1. "*Coefficient of luminous intensity R_I* " means the quotient of the luminous intensity I reflected by the retro-reflective device in the direction considered, divided by the normal illumination E_\perp of the retro-reflecting device for given angles of illumination, divergence and rotation.

$$R_I = \frac{I}{E_\perp}$$

NOTE R_I is often referred to as CIL. The unit is cd/lx.

2.3.2.2. "*Specific coefficient of retro-reflection (symbol R_A)*" means the quotient of the coefficient of luminous intensity R of a plane retro-reflecting surface and its area A

$$R_A = \frac{R_I}{A} = \frac{I}{E_\perp \cdot A}$$

The coefficient of retro-reflection R_A is expressed in candelas per m² per lx ($\text{cd} \cdot \text{m}^{-2} \cdot \text{lx}^{-1}$);

2.3.2.3. "*Luminance factor (symbol $\beta_{v,R}$)*" means the ratio of the tristimulus value Y of the sample and the tristimulus value of the perfect diffuser Y_0

$$\beta_{v,R} = \frac{Y}{Y_0}$$

2.3.2.4. "*Colour of the reflected light of the device*". The definitions of the colour of the reflected light are given in paragraph 2.11. of UN Regulation No. 48.

3. Administrative provisions

3.1. Application for approval

3.1.1. The application for type approval shall be submitted by the holder of the trade name or mark or by his duly accredited representative. It shall be accompanied by:

3.1.1.1. In case of retro-reflectors:

- (a) At the choice of the applicant, the application for type approval will specify that the device may be installed on a vehicle with different inclinations of the reference axis in respect to the vehicle reference planes and to the ground or, in the case of Classes IA, IB and IVA retro-reflectors, rotate around its reference axis; these different conditions of installation shall be indicated in the communication form;

- (b) Drawings, in triplicate, in sufficient detail to permit identification of the type, showing geometrically the position(s) in which the retro-reflecting device may be fitted to the vehicle, and in case of class IB or IIIB-retro-reflectors details of installation. The drawings must show the position intended for the approval number and class indicator in relation to the circle of the approval mark;
 - (c) A brief description giving the technical specifications of the materials of which the retro-reflecting optical unit is made;
 - (d) Samples of the retro-reflector of a colour specified by the manufacturer and, if necessary, the means of fixation; the number of samples to be submitted is specified in paragraphs 5.1. and 5.2.;
 - (e) If necessary, two samples in other colour(s) for simultaneous or subsequent extension of the approval to devices in other colour(s);
 - (f) In the case of a retro-reflector of Class IVA: samples of the retro-reflecting device and, if necessary, the means of fixation; the number of samples to be submitted is specified in paragraph 5.3.
- 3.1.1.2. In case of advance warning triangles:
- (a) Dimensional drawings in triplicate in sufficient detail to permit identification of the type;
 - (b) A brief description giving the technical specifications of the materials constituting the advance warning triangle and instructions for use;
 - (c) A copy of the instructions on its assembly for use;
 - (d) Samples of the retro-reflective and of the fluorescent areas; the number of samples to be submitted is specified in paragraph 5.9.
- 3.1.1.3. In case of retro-reflective marking plates:
- (a) Drawings, in triplicate, sufficiently detailed to permit identification of the type. The drawings shall show geometrically the position in which the marking plate is to be fitted to the rear end of the vehicle. They shall also show the position intended for the approval number and the identification symbol in relation to the circle of the approval mark;
 - (b) A brief description giving the technical specifications of the materials of which the retro-reflective areas are made;
 - (c) A brief description giving the technical specifications of the materials of which the fluorescent areas are made;
 - (d) Samples of the retro-reflective and of the fluorescent areas; the number of samples to be submitted is specified in paragraphs 5.7. and 5.8.
- 3.1.1.3.1. The Type Approval Authority shall verify the existence of satisfactory arrangements for ensuring effective control of the conformity of production before type approval is granted.
- 3.1.1.4. In case of retro-reflective marking materials:
- (a) Drawings, in triplicate, sufficiently detailed to permit identification of the type. The drawings shall show geometrically the orientation in which the marking materials are to be fitted to a vehicle. They shall also show the position intended for the approval number and the identification symbol in relation to the circle of the approval mark;
 - (b) A brief description giving the technical specifications of the retro-reflective marking materials;
 - (c) Samples of the retro-reflective marking materials, as specified in paragraphs 5.4. and 5.5.;

- (d) In the case of a type of retro-reflective marking material differing only by the trade name or mark from a type that has already been approved it shall be sufficient to submit:
- (i) A declaration by the retro-reflective marking material manufacturer that the type submitted is identical with (except in the trade name or mark) and has been produced by the same manufacturer as the type already approved, the latter being identified by its approval code;
 - (ii) Two samples bearing the new trade name or mark or equivalent documentation.
- 3.2. Approval
- 3.2.1. A separate approval is required for each retro-reflective device listed in paragraph 1.
- 3.2.2. Notice of approval or of extension or refusal or withdrawal of approval of a type of a device pursuant to this Regulation shall be communicated to the Contracting Parties to the 1958 Agreement which apply this Regulation, by means of a form conforming to the model in Annex 1;
- 3.2.3. An approval number shall be assigned to each type approved and shall be marked on the device following the requirements of paragraph 3.3. The same Contracting Party shall not assign the same number to another type of device of the same function, except in the case of an extension of the approval to a device differing only in colour.
- 3.2.4. If the approval granted in respect of a retro-reflecting device is extended to other such devices differing only in colour, the two samples in any other colour submitted in conformity with paragraph 3.1.1.1. (d) or 3.1.1.4. of this Regulation shall be required to meet only the colorimetric and photometric specifications, the other tests no longer being required. This paragraph is not applicable to devices of Class IVA.
- 3.2.5. The symbols identifying the retro-reflective devices to be referenced in the Annex 1 shall be as follows:

Table 1

List of retro-reflective devices and their symbols

<i>Retro-reflective devices</i>	<i>Symbol</i>	<i>Minimum "a" for examples of figures in Annex 10 (values in mm)</i>	<i>Paragraph</i>
Retro-reflector for motor vehicles (independent)	IA	5	5.1.
Retro-reflector for motor vehicles (combined with other signal lamps which are not watertight)	IB	5	5.1.
Retro-reflector for trailers (independent)	IIIA	5	5.1.
Retro-reflector for trailers (combined with other signal lamps which are not watertight)	IIIB	5	5.1.
Wide-angle retro reflector	IVA	5	5.1.
Retro-reflective marking material (Conspicuity marking, material for contour/strip marking)	C	8	5.2.
Retro-reflective marking material (Conspicuity marking, material for distinctive markings/graphics intended for a limited area)	D	8	5.2.
Retro-reflective marking material (Conspicuity marking, material for distinctive markings/graphics intended for an extended area)	E	8	5.2.

<i>Retro-reflective devices</i>	<i>Symbol</i>	<i>Minimum "a" for examples of figures in Annex 10 (values in mm)</i>	<i>Paragraph</i>
Retro-reflective marking material (Conspicuity marking, materials for distinctive markings or graphics as base or background in printing process for fully coloured logos and markings of class E in use which fulfil the requirements of class D materials)	D/E	8	5.2.
Retro-reflective marking material (material for extremities marking of class F)	F	8	5.2.
Retro-reflective marking plates for long or heavy vehicles (comprising retro-reflective and fluorescent materials) Marking plate of class 1 or class 2	RF	5	5.2.
Retro-reflective marking plates for long or heavy vehicles (comprising retro-reflective only materials) Marking plate of class 3, class 4 or class 5	RR	5	5.2.
Retro-reflective marking plates for slow moving vehicles (comprising retro-reflective and fluorescent materials) Marking plate of class 1	RF	5	5.2.
Retro-reflective marking plates for slow moving vehicles (comprising retro-reflective only materials) - Marking plate of class 2	RR	5	5.2.
Advance Warning Triangle (Type 1)	WT1	8	5.3.
Advance Warning Triangle (Type 2)	WT2	8	5.3.

3.2.6. The applicable change indexes for each device relating to the series of amendments shall be as follows (see also paragraph 6.1.1.):

Table 2
Series of amendments and change index

<i>Series of amendments to the Regulation</i>	<i>00</i>	<i>01</i>	
<i>Device</i>	<i>Change Index for the specific device</i>		
Retro-reflector for motor vehicles (independent)	0	1	
Retro-reflector for motor vehicles (combined with other signal lamps which are not watertight)	0	1	
Retro-reflector for trailers (independent)	0	1	
Retro-reflector for trailers (combined with other signal lamps which are not watertight)	0	1	
Wide-angle retro reflector	0	1	
Retro-reflective marking material (Conspicuity marking, material for contour/strip marking)	0	1	
Retro-reflective marking material (Conspicuity marking, material for distinctive markings/graphics intended for a limited area)	0	1	
Retro-reflective marking material (Conspicuity marking, material for distinctive markings/graphics intended for an extended area)	0	1	
Retro-reflective marking material (Conspicuity marking, materials for distinctive markings or graphics as base or background in printing process for fully coloured logos and	0	1	

<i>Series of amendments to the Regulation</i>	<i>00</i>	<i>01</i>	
<i>Device</i>	<i>Change Index for the specific device</i>		
markings of class E in use which fulfil the requirements of class D materials)			
Retro-reflective marking material (material for extremities marking of class F)	0	1	
Retro-reflective marking plates for long or heavy vehicles (comprising retro-reflective and fluorescent materials) Marking plate of class 1 or class 2	0	1	
Retro-reflective marking plates for long or heavy vehicles (comprising retro-reflective only materials) Marking plate of class 3, class 4 or class 5	0	1	
Retro-reflective marking plates for slow moving vehicles (comprising retro-reflective and fluorescent materials) Marking plate of class 1	0	1	
Retro-reflective marking plates for slow moving vehicles (comprising retro-reflective only materials) - Marking plate of class 2	0	1	
Advance Warning Triangle (Type 1)	0	1	
Advance Warning Triangle (Type 2)	0	1	

Notes to Table 2:

A dash “-“ means that this device is not available for type approvals according to the corresponding series of amendments.

- 3.3. Approval marking and other markings
- 3.3.1. General provisions
- 3.3.1.1. Every device belonging to an approved type shall comprise a space of sufficient size for the Unique Identifier as referred to in the 1958 Agreement and other markings as defined in paragraph 3.3.4.2. or, the approval marking and other markings as defined in paragraph 3.3.4.2.
- 3.3.1.2. All markings shall be clearly legible and indelible.
- 3.3.1.3. With regard to the size of the approval marking the value for “a” is defined in Table 1.
Examples of the arrangement of the markings are shown in Annex 10.
- 3.3.2. The approval marking shall consist of:
- 3.3.2.1. The approval mark, i.e. a circle surrounding the letter "E" followed by the distinguishing number of the country which has granted approval.
- 3.3.2.2. The four to six-digit sequential number being part of the approval number prescribed in paragraph 3.2.3.2. This sequential number shall be placed close to the approval mark.
- 3.3.2.3. The symbols identifying the retro-reflective device prescribed in paragraph 3.2.5.
- 3.3.2.4. The number of this Regulation followed by the letter “R” and the two digits indicating the series of amendments in force at the time of issue of the approval.
- 3.3.3. Unique Identifier (UI)
- 3.3.3.1. The approval marking as defined in paragraph 3.3.2. may be replaced by the Unique Identifier, if available. The Unique Identifier mark shall follow the format in the example shown below:

Figure I
Unique Identifier (UI)

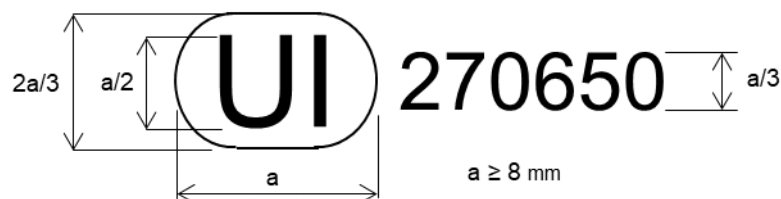

The above Unique Identifier marked on the retro-reflective device shows that the type concerned has been approved and that the relevant information on that type approval can be accessed on the UN secure internet database by using 270650 as the Unique Identifier.

- 3.3.4. Marking requirements
- 3.3.4.1. Retro-reflective devices shall bear the trade name or mark of the applicant.
- 3.3.4.2. Retro-reflective devices shall bear
- 3.3.4.2.1. in case of a retro-reflector of Class IA, IIIA, IB, IIIB or IVA, the word "TOP" inscribed horizontally on the highest part of the illuminating surface, if such an indication is necessary to determine without ambiguity the angle or angles of rotation prescribed by the manufacturer.
- 3.3.4.2.2. in case of retro-reflective marking material of Class C, D, E or F an orientation mark "TOP" on any marking material whose retro-reflective system is not omni-rotational.
- 3.3.4.2.3. in case of retro-reflective marking plates of Class 1, 2, 3, 4 or 5, on the plates whose retro-reflective system is not omni-rotational, the word "TOP" inscribed horizontally on the part of the plates which is intended to be the highest part of the plate when mounted on the vehicle.
- 3.3.5. Marking location
- 3.3.5.1. The approval marking or the Unique Identifier and the markings in paragraphs 3.3.4. shall be clearly legible on the retroreflective device.
- 3.3.5.2. In case of retro-reflective marking material of Class C, D, E or F. These markings shall be positioned on the outside at least once:
- (a) on strips in a 0.5 m distance,
 - (b) on areas within 100 mm x 100 mm.
- 3.3.6. Grouped, combined or reciprocally incorporated lamps in retroreflective devices.
- 3.3.6.1. Where grouped, combined or reciprocally incorporated lamps have been found to comply with the requirements of several UN Regulations, a single approval mark with the four to six-digit sequential number or Unique Identifier may be affixed. This marking may be located anywhere on the grouped, combined or reciprocally incorporated lamps, provided that:
- 3.3.6.1.1. It is visible after their installation.
- 3.3.6.1.2. No part of the grouped, combined or reciprocally incorporated lamps that transmits light can be removed without at the same time removing the approval mark with the four to six-digit sequential number or the Unique Identifier.
- 3.3.6.2. The size of the components of a single approval mark shall not be less than the minimum size required for the smallest of the individual marks by the pertinent UN Regulations under which approval has been granted.

- 3.3.6.3. Annex 10 gives examples of approval marking arrangements for grouped, combined or reciprocally incorporated lamps with all the additional symbols mentioned above.
- 3.4. Modifications of a type of retro-reflective device for motor vehicles and their trailers and extension of approval
- 3.4.1. Every modification of the type of retro-reflective device shall be notified to the Type Approval Authority which approved the type. The Authority may then either:
- 3.4.1.1. Consider that the modifications made are unlikely to have an appreciable adverse effect, and that in any case the retro-reflective device still meets the requirements; or
- 3.4.1.2. Require a further report from the technical service responsible for conducting the tests.
- 3.4.2. Confirmation or refusal of approval, specifying the alterations, shall be communicated by the procedure specified in paragraph 3.2.2. to the Contracting Parties to the 1958 Agreement applying this Regulation.
- 3.4.3. The Type Approval Authority issuing the extension of approval shall assign a series number for such an extension and inform thereof the other Contracting Parties to the 1958 Agreement applying the UN Regulation under which the approval has been granted by means of a communication form conforming to the model in Annex 1.
- 3.5. Conformity of production
- The conformity of production procedures shall comply with those set out in the 1958 Agreement, Schedule 1 (E/ECE/TRANS/505/Rev.3), with the following requirements:
- 3.5.1. Retro-reflectors approved under this Regulation shall be so manufactured as to conform to the type approved by meeting the requirements set forth in paragraphs 4. and 5.
- 3.5.1.1. The minimum requirements for conformity of production control procedures set forth in Annex 2 shall be complied with.
- 3.5.1.2. The minimum requirements for sampling by an inspector set forth in Annex 3 shall be complied with.
- 3.5.2. The authority which has granted type approval may at any time verify the conformity control methods applied in each production facility. The normal frequency of these verifications shall be once every two years.
- 3.5.3. Advance warning triangles approved under this Regulation shall be so manufactured as to conform to the type approved under this Regulation.
- The compliance with the requirements set forth in paragraphs 4. and 5. shall be verified as follows:
- 3.5.3.1. In addition, the stability in time of the optical properties and colour of retro-reflecting optical units of advance warning triangles conforming to an approved type and in use shall be verified. In the event of a systematic deficiency of the retro-reflecting optical units of advance warning triangles in use and conforming to an approved type, approval may be withdrawn. A "systematic deficiency" shall be deemed to exist where an approved type of advance warning triangle fails to meet the requirements of paragraph 5.
- 3.5.4. Any retro-reflective marking material approved to this Regulation shall be so manufactured as to conform to the type approved by meeting the requirements set forth in paragraphs 4. and 5.
- 3.5.4.1. The conformity of production shall not be contested if the mean value of the photometric measurements of five specimens taken at random deviates

unfavourably by not more than 20 per cent from the prescribed values given in paragraphs 4. and 5.

- 3.5.4.2. The conformity of production shall not be contested, if the mean value of the colorimetric properties of five specimens taken at random meet the specifications of paragraphs 4. and 5. to be judged by visual inspection.
- 3.5.4.3. The authority which has granted type approval may at any time verify the conformity control methods applied in each production facility. The normal frequency of these verifications shall be once every two years.
- 3.5.5. Any retro-reflective marking plate approved to this Regulation shall be so manufactured as to conform to the type approved by meeting the requirements set forth in paragraphs 4. and 5. (as to resistance to external agents, only paragraph 5.7.6.1. is applied).
- 3.5.5.1. The minimum requirements for conformity of production control procedures set forth in Annex 2 to this Regulation shall be complied with.
- 3.5.5.2. The minimum requirements for sampling by an inspector set forth in Annex 3 to this Regulation shall be complied with.
- 3.5.5.3. The authority which has granted type approval may at any time verify the conformity control methods applied in each production facility. The normal frequency of these verifications shall be once every two years.
- 3.6. Penalties for non-conformity of production
- 3.6.1. The approval granted may be withdrawn if the requirements in this Regulation are not met.
- 3.6.2. If a Contracting Party to the 1958 Agreement which applies this Regulation withdraws an approval it has previously granted, it shall forthwith so notify the other Contracting Parties applying this Regulation by means of a communication form conforming to the model in Annex 1.
- 3.7. Production definitively discontinued
- If the holder of the approval completely ceases to manufacture a retro-reflective device approved in accordance with this Regulation, he shall so inform the authority which granted the approval. Upon receiving the relevant communication, that authority shall inform thereof the other Contracting Parties to the Agreement applying this Regulation by means of a communication form conforming to the model in Annex 1.
- 3.8. Name and address of the Technical Services responsible for conducting approval tests; and of Type Approval Authorities
- The Contracting Parties to the Agreement applying this Regulation shall communicate to the United Nations secretariat the names and addresses of the Technical Services responsible for conducting approval tests and of the Type Approval Authorities which grant approval and to which forms certifying approval or extension or refusal or withdrawal of approval, or the definitive discontinuation of production issued in other countries, are to be sent.

4. General requirements

The requirements contained in sections 5. "General specifications" and 6. "Individual specifications" and in the Annexes referenced in the said sections of UN Regulations Nos. 48, 53, 74 or 86, and their series of amendments in force at the time of application for the retro-reflecting device type approval shall apply to this Regulation.

The requirements pertinent to each retro-reflecting device and to the category/ies of vehicle on which the retro-reflecting device is intended to be

installed shall be applied, where its verification at the moment of retro-reflecting device type approval is feasible.

- 4.1. For the purpose of this Regulation, retro-reflectors or retro-reflective marking materials or marking plates or advance warning triangles for general descriptions herein after referred to as "retro-reflective devices".
 - 4.1.1. Retro-reflective devices shall be so constructed that they function satisfactorily and will continue to do so in normal use. In addition, they must not have any defect in design or manufacture that is detrimental to their efficient operation or to their maintenance in good condition.
 - 4.1.2. The components of retro-reflective devices or parts thereof shall not be capable of being easily dismantled.
 - 4.1.3. The means of attachment of the retro-reflective marking materials shall be durable and stable.
 - 4.1.4. The outer surface of retro-reflective devices shall be easy to clean. The surface shall therefore not be rough and any protuberances they may exhibit shall not prevent easy cleaning.
 - 4.1.5. There shall be no access to the inner surface of the retro-reflectors when in normal use.
 - 4.1.6. In case of retro-reflectors
 - 4.1.6.1. Retro-reflectors may consist of a combined retro-reflecting optical unit and filter, which must be so designed that they cannot be separated under normal conditions of use.
 - 4.1.6.2. The colouring of retro-reflecting optical units and filters by means of paint or varnish is not permitted.
- 4.2. Colorimetric test conditions
 - 4.2.1. Test procedure for night time colours:
 - 4.2.1.1. These specifications shall apply only to white, red or amber retro-reflective devices
 - 4.2.1.2. For testing the colour of the retro-reflective device, the device shall be illuminated by CIE Standard Illuminant A, with an angle of divergence of $1/3^\circ$ and an illumination angle of $\beta_1 = \beta_2 = 0$ degree, or, if this produces a colourless surface reflection, an angle $\beta_1 = \pm 5$ degrees, $\beta_2 = 0^\circ$, the trichromatic coordinates of the reflected luminous intensity must be within the limits according to the specifications in paragraph 2.30. of UN Regulation No. 48.
 - 4.2.1.3. White retro-reflective devices must not produce a selective reflection, that is to say, the trichromatic coordinates "x" and "y" of Standard Illuminant "A" used to illuminate the retro-reflective device must not undergo a change of more than 0.01 after reflection by the retro-reflective device.
 - 4.2.2. Test procedure for day time colours:

For testing the daytime colour, the material shall be illuminated by the CIE Standard Illuminant D65 (ISO 11664-2:2007(E)/CIE S 014-2/E:2006) using geometry (45a:0) or (0:45a) as described in Part 2 of Annex 4.
- 4.3. Determination of the luminance factor:

For the determination of the luminance factor, the sample shall be tested with the method as described in Part 2 of Annex 4.

5. Specific technical requirements

- 5.1. Technical requirements concerning retro-reflectors of the Classes IA and IB (Symbols "IA" and "IB")
- 5.1.1. Every retro-reflector of the Classes IA and IB, when tested according to paragraph 5.1.7., shall meet:
- (a) The dimensions and shape requirements set forth in Annex 5; and
 - (b) The photometric and colorimetric requirements as specified in paragraphs 5.1.4. to 5.1.5.; and
 - (c) The physical and mechanical requirements set forth in paragraph 5.1.7., depending on the nature of the materials and construction of the retro-reflective devices.
- 5.1.2. The applicant shall submit ten samples for approval which shall be tested in the chronological order as indicated in paragraph 5.1.7.
- 5.1.3. Test procedure.
- 5.1.3.1. After verification of the general specifications (paragraph 4.) and the specifications of shape and dimensions (Annex 5), the ten samples shall be subjected to the heat resistance test described in Part 1 of Annex 6 and at least one hour after this test examined as to their colorimetric characteristics in paragraph 5.1.5. and R_l in paragraph 5.1.4., for an angle of divergence of $20'$ and an illumination angle $\beta_1 = \beta_2 = 0^\circ$ or if necessary, in the position defined in Part 1 of Annex 4, paragraphs 1.1. and 1.2.
- The two retro-reflectors giving the minimum and maximum values shall then be fully tested as shown in paragraph 5.1.4.
- These two samples shall be kept by the laboratories for any further checks which may be found necessary.
- Four samples out of the remaining eight samples shall be selected at random and divided into two groups of two in each group.
- The other eight samples shall be divided into four groups of two:
- First group: The two samples shall be subjected successively to the water penetration test (Part 2 of Annex 6) and then, if this test is satisfactory, to the tests for resistance to fuels and lubricants (Parts 1 and 2 of Annex 7).
- Second group: The two samples shall, if necessary, be subjected to the corrosion test in Part 4 of Annex 6, and then to the abrasive-strength test of the rear face of the retro-reflective device in Part 5 of Annex 6.
- Third group: The two samples shall be subjected to the test for stability in time of the optical properties of retro-reflective device in Part 3 of Annex 4.
- Fourth group: The two samples shall be subjected to the resistance to weathering test (Part 6 of Annex 6).
- 5.1.3.2. After undergoing the tests referred to in the paragraph 5.1.3.1., the retro-reflectors in each group must have:
- 5.1.3.2.1. A colour which satisfies the conditions laid down in paragraph 5.1.5.
 - 5.1.3.2.2. A R_l which satisfies the conditions laid down in paragraph 5.1.4. The verification shall be performed only for an angle of divergence of $20'$ and an illumination angle of $\beta_1 = \beta_2 = 0^\circ$ or, if necessary, in all positions specified in Part 1 of Annex 4, paragraphs 1.1. and 1.2.

- 5.1.4. Minimum values for the R_1 values of retro-reflection
- 5.1.4.1. When applying for approval, the applicant shall specify one or more or a range of axis of reference, corresponding to the illumination angle $\beta_1 = \beta_2 = 0^\circ$ in the table of coefficients of luminous intensity R_1 .
- 5.1.4.2. In the case where more than one or a range of different axis of reference are specified by the manufacturer, the photometric measurements shall be repeated making reference each time to a different axis of reference or to the extreme axis of reference of the range specified by the manufacturer.
- 5.1.4.3. For photometric measurements, only the illuminating surface defined by the planes contiguous to the outermost parts of the optical system of the retro-reflective device as indicated by the manufacturer and contained within a circle of 200 mm diameter for Class IA or IB shall be considered, and the illuminating surface itself shall be limited to 100 cm² though the surfaces of the retro-reflecting optical units need not necessarily attain this area. The manufacturer shall specify the perimeter of the area to be used.
- 5.1.4.4. Class IA and Class IB
- 5.1.4.4.1. When measured as described in paragraph 3 of Part 1 of Annex 4, the R_1 values for red retro-reflectors must be equal to or greater than those in Table 3, expressed in millicandelas per lux, for the angles of divergence and illumination shown.

Table 3
Requirements for R_1 values of Retro-reflectors

				<i>Angles in degrees</i>					
Class	Colour	Illumination angles [°]	Vertical β_1	0°	$\pm 10^\circ$	$\pm 5^\circ$	0°	0°	0°
			Horizontal β_2	0°	0°	$\pm 20^\circ$	$\pm 30^\circ$	$\pm 40^\circ$	$\pm 50^\circ$
				<i>Minimum requirements for R_1 values in mcd·lx⁻¹</i>					
IA, IB	White	<i>Angle of divergence α</i>	20'	1.20·10 ³	8.00·10 ²	4.00·10 ²	--	--	--
			1°30'	2.0·10 ¹	1.12·10 ¹	1.0·10 ¹	--	--	--
	Amber		20'	7.50·10 ²	5.00·10 ²	2.50·10 ²	--	--	--
			1°30'	1.25·10 ¹	7·10 ⁰	6.25·10 ⁰	--	--	--
	Red		20'	3.00·10 ²	2.00·10 ²	1.00·10 ²	--	--	--
			1°30'	5·10 ⁰	2.8·10 ⁰	2.5·10 ⁰	--	--	--
IIIA, IIIB	White	20'	1.80·10 ³	8.00·10 ²	6.00·10 ²	--	--	--	
		1°30'	4.8·10 ¹	3.2·10 ¹	3.2·10 ¹	--	--	--	
	Amber	20'	1.13·10 ³	5.00·10 ²	3.75·10 ²	--	--	--	
		1°30'	3.0·10 ¹	2.0·10 ¹	2.0·10 ¹	--	--	--	
	Red	20'	4.50·10 ²	2.00·10 ²	1.50·10 ²	--	--	--	
		1°30'	1.2·10 ¹	8·10 ⁰	8·10 ⁰	--	--	--	
IV	White	20'	1.80·10 ³	1.20·10 ³	--	5.40·10 ²	4.70·10 ²	4.00·10 ²	
		1°30'	3.4·10 ¹	2.4·10 ¹	--	1.5·10 ¹	1.5·10 ¹	1.5·10 ¹	
	Amber	20'	1.13·10 ³	7.50·10 ²	--	3.35·10 ²	2.90·10 ²	2.50·10 ²	
		1°30'	2.1·10 ¹	1.5·10 ¹	--	1.0·10 ¹	1.0·10 ¹	1.0·10 ¹	
	Red	20'	4.50·10 ²	3.00·10 ²	--	1.35·10 ²	1.15·10 ²	1.00·10 ²	
		1°30'	9·10 ⁰	6·10 ⁰	--	4·10 ⁰	4·10 ⁰	4·10 ⁰	

R_1 values lower than those shown in the last two columns of Table 3 are not permissible within the solid angle having the centre of reference as its apex and bounded by the planes intersecting along the following lines:

$(\beta_1 = \pm 10^\circ, \beta_2 = 0^\circ)$ $(\beta_1 = \pm 5^\circ, \beta_2 = \pm 20^\circ)$.

- 5.1.4.5. However, in the case where a retro-reflector of Class IA or Class IB, is intended to be installed with its H plane at a mounting height less than 750 mm above the ground, the R_1 values are verified only up to an angle of 5° downwards.
- 5.1.5. Colour of the reflected light of the device:
- 5.1.5.1. The testing of the colour for retro-reflector (night-time colour) shall be carried out according to the method described in paragraph 4.2.1.
- 5.1.5.2. The trichromatic coordinates of the reflected luminous flux must be within the limits for the night-time colours red, amber or white as specified in UN Regulation No. 48.
- 5.1.6. Special specification (tests) / resistance to external agents
- Depending on the nature of the materials of which the retro-reflectors and, in particular, their optical units, are made, the Type Approval Authorities may authorize laboratories to omit certain unnecessary tests, subject to the express reservation that such omission must be mentioned under "Remarks" on the form notifying approval.
- This is only applicable to tests described in Part 3 of Annex 4, in Parts 4, 5 and 6 of Annex 6.
- 5.1.7. Chronological order of tests

Table 4
Chronological order of tests (Classes IA, IB, IIIA and IIIB)

Reference	Tests	Samples									
		a	b	c	d	e	f	g	h	i	j
-	General specifications: visual inspection	x	x	x	x	x	x	x	x	x	x
Annex 5	Shapes and dimensions: visual inspection	x	x	x	x	x	x	x	x	x	x
Part 1 of Annex 6	Heat: 48 h at $65^\circ \pm 2^\circ\text{C}$	x	x	x	x	x	x	x	x	x	x
	Visual inspection for distortion	x	x	x	x	x	x	x	x	x	x
Par. 4.2.	Colorimetry: visual inspection	x	x	x	x	x	x	x	x	x	x
	Trichromatic coordinates in case of doubt		x								
Part 1 of Annex 4	Photometry: limited to $20'$ and $\beta_1 = \beta_2 = 0^\circ$	x	x	x	x	x	x	x	x	x	x
Part 1 of Annex 4	Complete photometry			x	x						
Part 3 of Annex 6	Water: 10 min. in normal position							x	x		
	10 min. in inverted position							x	x		
	visual inspection							x	x		
Par. 4.2.	Colorimetry: visual inspection							x	x		
	Trichromatic coordinates in case of doubt							x	x		
Part 1 of Annex 4	Photometry: limited to $20'$ and $\beta_1 = \beta_2 = 0^\circ$							x	x		
Part 1 of Annex 7	Motor fuels: 5 min.							x	x		
	visual inspection							x	x		
Part 2 of Annex 7	Oils: 5 min.							x	x		
	visual inspection							x	x		
Par. 4.2.	Colorimetry: visual inspection							x	x		
	Trichromatic coordinates in case of doubt							x	x		
Part 1 of Annex 4	Photometry: limited to $20'$ and $\beta_1 = \beta_2 = 0^\circ$							x	x		

Reference	Tests	Samples									
		a	b	c	d	e	f	g	h	i	j
Part 4 of Annex 6	Corrosion: 24 hours 2 hours interval 24 hours visual inspection					x	x				
Part 4 of Annex 6	Rear face: 1 min. visual inspection					x	x				
Par. 4.2.	Colorimetry: visual inspection Trichromatic coordinates in case of doubt					x	x				
Part 1 of Annex 4	Photometry: limited to 20' and $\beta_1 = \beta_2 = 0^\circ$					x	x				
Part 3 of Annex 4	Stability in time										
Par. 4.2.	Colorimetry: Visual inspection or trichromatic coordinates										
Part 1 of Annex 4	Photometry: limited to 20' and $\beta_1 = \beta_2 = 0^\circ$										
Part 6 of Annex 6	Resistance to weathering										
Par. 4.2.	Colorimetry: Visual inspection or trichromatic coordinates										
Part 1 of Annex 4	Photometry: limited to 20' and $\beta_1 = \beta_2 = 0^\circ$										

Table 5
Chronological order of tests (Class IVA)

Reference	Tests	Samples									
		a	b	c	d	e	f	g	h	i	j
-	General specifications: visual inspection	x	x	x	x	x	x	x	x	x	x
Annex 5	Shape and dimensions: visual inspection	x	x	x	x	x	x	x	x	x	x
Part 1 of Annex 6	Heat: 48 h at 65 °C ± 2°C Visual inspection for distortion	x	x	x	x	x	x	x	x	x	x
Par. 4.2.	Colorimetry: visual inspection Trichromatic coordinates in case of doubt	x	x	x	x	x	x	x	x	x	x
Part 1 of Annex 4	Photometry: limited to 20' and $\beta_1 = \beta_2 = 0^\circ$	x	x	x	x	x	x	x	x	x	x
Part 1 of Annex 4	Complete photometry	x	x								
Part 2 of Annex 6	Water: 10 min. in normal position 10 min. in inverted position visual inspection			x	x						
Part 1 of Annex 7	Motor fuels: 5 min. visual inspection			x	x						
Part 2 of Annex 7	Oils: 5 min. visual inspection			x	x						
Par. 4.2.	Colorimetry: visual inspection Trichromatic coordinates in case of doubt			x	x						

Reference	Tests	Samples									
		a	b	c	d	e	f	g	h	i	j
Part 1 of Annex 4	Photometry: limited to 20' and $\beta_1 = \beta_2 = 0^\circ$			x	x						
Part 4 of Annex 6	Corrosion: 24 hours 2 hours' interval 24 hours visual inspection					x	x				
Part 4 of Annex 6	Rear face: 1 min. visual inspection					x	x				
Part 4 of Annex 8	Impact visual inspection					x	x				
Par. 4.2.	Colorimetry: visual inspection Trichromatic coordinates in case of doubt					x	x				
Part 1 of Annex 4	Photometry: limited to 20' and $\beta_1 = \beta_2 = 0^\circ$					x	x				

- 5.2. Technical requirements concerning retro-reflective marking materials and plates
- 5.2.1. Every retro-reflective marking, when tested according to paragraph 5.2.4.5., shall meet:
- The dimensions and shape requirements set forth in Annex 5; and
 - The photometric and colorimetric requirements as specified in paragraphs 5.2.5. and 5.2.6.; and
 - The physical and mechanical requirements set forth in paragraph 5.2.7.
- 5.2.2. The applicant shall submit for approval:
- 5.2.2.1. Five test samples representing strips of retro-reflective marking materials of classes C and F have to be submitted to the test laboratory. In the case of strips, at least a length of 3 metres shall be provided
- 5.2.2.2. Five test samples representing plates of retro-reflective marking plates of HLV Classes 1, 2, 3, 4, 5 or SMV Classes 1 or 2 have be submitted to the test laboratory.
- In case of HLV plates
- Two large rear marking plates for trucks and tractors and two large rear marking plates for trailers and semi-trailers (or their equivalent in smaller plates) shall be supplied to the testing laboratory for the various tests to be conducted.
- In case of SMV plates
- Five marking plates shall be supplied to the testing laboratory for the various tests to be conducted.
- 5.2.3. Chronological order of tests for retro-reflective marking materials of Classes C, F and D, E
- 5.2.3.1. Five test samples representing either strips or planes of retro-reflective marking materials have to be submitted to the test laboratory. In the case of strips, at least a length of 3 metres shall be provided; in the case of planes, at least a square of 500 mm x 500 mm shall be provided.

- 5.2.3.2. The test samples shall be representative of current production, manufactured in accordance with the recommendation of the manufacturer(s) of the retro-reflective marking materials. ¹
- 5.2.3.3. After verification of the general specifications (paragraph 4.) and the specifications of shape and dimensions (Annex 5), the samples shall be subjected to the heat resistance test described in Part 3 of Annex 6, prior to the tests described in Parts 1 and 2 of Annex 6.
- 5.2.3.4. The photometric and colorimetric measurements may be made on five samples. The mean values should be taken.
- 5.2.3.5. For other tests, samples which have not undergone any testing should be used.
- 5.2.4. Chronological order of tests for HLV plates of Classes, 1, 2, 3, 4, 5
- 5.2.4.1. Test procedure
- Every retro-reflective marking plate shall meet the requirements of the checks and tests described in paragraph 5.2.1.
- 5.2.4.2. In the case of Plates:
- A specimen of a complete plate shall be subjected to a test of rigidity of plates as specified in Part 5 of Annex 8.
- 5.2.4.3. The test samples shall be representative of current production, manufactured in accordance with the recommendation of the manufacturer(s) of the retro-reflective marking materials. ¹
- 5.2.4.4. The samples shall be tested in the chronological order indicated in paragraph 5.2.7.
- 5.2.4.5. Test procedure
- 5.2.4.5.1. After verification of the general specifications (paragraph 4.) and the specifications of shape and dimensions (Annex 5), the samples shall be subjected to the heat resistance test described in Part 1 of Annex 6, prior to the tests described in the paragraphs 5.2.5. and 5.2.6.
- 5.2.4.5.2. The photometric and colorimetric measurements may be made on five samples. The mean values should be taken.
- 5.2.4.5.3. For other tests, samples which have not undergone any testing should be used.
- 5.2.5. Minimum values for the coefficient of retro-reflection
- Photometric specifications for retro-reflective marking materials and plates:
- 5.2.5.1. When measured as described in Part 1 of Annex 4, the coefficient of retro-reflection R_A in candelas per m² per lux (cd/m²/lux) of the retro-reflective areas in new condition shall be at least as indicated in Table 6 for white, yellow and red materials.

Table 6

Minimum values for the Coefficient of Retro-reflection R_A

Observation angle α [°] $\alpha=0.33(20')$	Minimum values for the Coefficient of Retro-reflection R_A in $cd \cdot m^{-2} \cdot lx^{-1}$					
	Vertical β_1	0°	0°	0°	0°	0°
Entrance Angle β [°]	Horizontal β_2	5°	20°	30°	40°	60°
	Yellow	3.00·10 ²	--	1.30·10 ²	7.5·10 ¹	1.0·10 ¹
Class C	White	4.50·10 ²	--	2.00·10 ²	9.5·10 ¹	1.6·10 ¹

¹ Test samples of retro-reflective marking materials shall be applied to edged and degreased aluminium panels of 2 mm thickness and shall be conditioned for 24 hours at 23°C ± 2°C at 50% ± 5% relative humidity prior to testing.

	Red	1.20·10 ²	6.0·10 ¹	3.0·10 ¹	1.0·10 ¹	--
Class F, 5	White	4.50·10 ²	--	2.00·10 ²	9.5·10 ¹	1.6·10 ¹
	Red	1.20·10 ²		3.0·10 ¹	1.0·10 ¹	2·10 ⁰
Class 1, 2, 3, 4	Yellow	3.00·10 ²	--	1.80·10 ²	7.5·10 ¹	1.0·10 ¹
	Red	1.0·10 ¹	--	7·10 ⁰	4·10 ⁰	--
Class SMV	Red of the outer border (class 1, 2)	1.20·10 ²	--	6.0·10 ¹	3.0·10 ¹	1.0·10 ¹
	Red of the enclosed triangle (class 2)	1.0·10 ¹	--	7·10 ⁰	4·10 ⁰	--

Note: If the sample is provided with an orientation mark, the specified values must only be observed for this orientation. Test samples without an orientation mark must be observed for values at 0° and 90° orientations as well.

- 5.2.5.1.1. After performing the test to the resisting to weathering as described in Part 6 of Annex 6, the retro-reflective marking shall be measured as described in Part 1 of Annex 4. The coefficient of retro-reflection R' in candelas per m² per lux (cd/m²/lux) of the retro-reflective areas shall be at least 80 per cent as indicated in Table 6 for white, yellow and red materials for the measuring geometry for $\alpha=0.33^\circ$, $\beta_2=5^\circ$ and $\beta_1=0^\circ$.
- 5.2.5.2. For Classes D and E retro-reflective marking materials the maximum values of the coefficient of retro-reflection are less or equal to the value defined in Table 7, and are intended to be used in distinctive markings, graphics.

Table 7

Photometric specifications for retro-reflective marking materials of class D and class E: Maximum values for the Coefficient of Retro-reflection R_A

Observation angle α [°] $\alpha=0.33(20')$	Maximum values for the Coefficient of Retro-reflection R_A in $cd\cdot m^{-2}\cdot lx^{-1}$					
	Entrance Angle β [°]	Vertical β_1	0°	0°	0°	0°
Horizontal β_2		5°	20°	30°	40°	60°
Any colour	class D	1.50·10 ²	--	6.5·10 ¹	3.7·10 ¹	5·10 ⁰
	class E	5.0·10 ¹	--	2.2·10 ¹	1.2·10 ¹	1·10 ⁰

Note: If the sample is provided with an orientation mark, the specified values must only be observed for this orientation. Test samples without an orientation mark must be observed for values at 0° and 90° orientations as well.

- 5.2.5.2.1. After performing the test to the resisting to weathering as described in Part 6 of Annex 6, for Classes D and E retroreflective marking materials the maximum values of the coefficient of retro-reflection are shall not exceed the value defined in Table 7 for the measuring geometry for $\alpha=0.33^\circ$, $\beta_2=5^\circ$ and $\beta_1=0^\circ$.
- 5.2.5.3. The subtended angle at the sample shall not be larger than 80°.
- 5.2.6. Colour of the reflected light of the device
- 5.2.6.1. The testing of the colour for retro-reflective device (night-time colour) shall be carried out according to the method described in paragraph 4.2.1.
- 5.2.6.2. The trichromatic coordinates of the reflected luminous intensity must be within the limits for the night-time colours red, amber or white as specified in UN Regulation No. 48.
- 5.2.6.3. The testing of the day-time colour for retro-reflective device shall be carried out according to the method described in paragraph 4.2.2.
- 5.2.6.4. Luminance factor determined in accordance to Part 2 of Annex 4:

for red colour shall be $\beta_{v,R} \geq 0.03$,

for yellow colour shall be $\beta_{v,R} \geq 0.16$,

for white colour, it shall be $\beta_{v,R} \geq 0.25$.

- 5.2.7. Special specification (tests) / resistance to external agents
- 5.2.7.1. Resistance to weathering
A specimen shall be subjected to a test as specified in Part 6 of Annex 6.
- 5.2.7.2. Resistance to corrosion
A specimen of the sample unit shall be subjected to a test as specified in Part 4 of Annex 6.
- 5.2.7.3. Resistance to fuels
A specimen of the sample unit shall be subjected to a test as specified in Part 1 of Annex 7.
- 5.2.7.4. Resistance to heat
A specimen of the sample unit shall be subjected to a test as specified in Part 1 of Annex 6.
- 5.2.7.5. Resistance to cleaning
A specimen of the sample unit shall be subjected to a test as specified in Part 1 of Annex 8.
- 5.2.7.6. Stability of photometric properties
A specimen of the sample unit shall be subjected to a test as specified in Part 3 of Annex 4.
- 5.2.7.7. Resistance to penetration of water
A specimen of the sample unit shall be subjected to a test as specified in Part 2 of Annex 6.
- 5.2.7.8. Bonding strength (in the case of adhesive materials)
A specimen of the sample unit shall be subjected to a test as specified in Part 2 of Annex 8.
- 5.2.7.9. Flexing
For samples that are to be adhered to a flexible substrate, i.e. tarpaulin, the following shall apply:
A specimen of the sample unit shall be subjected to a test as specified in Part 3 of Annex 8.
- 5.3. Technical requirements concerning advance warning triangles of Type 1 and 2
- 5.3.1. Retro-reflective devices of this paragraph must satisfy the conditions as to
- (a) Dimensions and shape set forth in Annex 5; and
 - (b) The photometric and colorimetric as specified in paragraphs 5.3.4. to 5.3.5.; and
 - (c) The physical and mechanical requirements set forth in Part 1 of Annex 7, in Parts 4 to 6 of Annex 6 and in Annex 9.
- 5.3.2. The applicant shall submit for approval:
- 5.3.2.1. Four samples of the advance warning triangle and at least two protective covers if the advance warning triangles are to be supplied with protective covers;
- 5.3.2.2. Two samples of the fluorescent or fluorescent retro-reflecting material in which a square of 100 mm x 100 mm can be inscribed and which are fully

representative of the material applied under the same conditions to the same base material as used for the advance warning triangle;

- 5.3.2.3. In the case of a type of advance-warning triangle differing only by the trade name or mark from a type that has already been approved it shall be sufficient to submit:
- 5.3.2.3.1. A declaration by the advance-warning triangle manufacturer that the type submitted is identical (except in the trade name or mark) with and has been produced by the same manufacturer as, the type already approved, the latter being identified by its approval number;
- 5.3.2.3.2. Two samples bearing the new trade name or mark or equivalent documentation.
- The samples shall be tested in the chronological order indicated in paragraph 5.9.6.
- 5.3.3. Test procedure
- Every advance warning triangle and its protective cover, if any, shall meet the requirements of the checks and tests described in Annex 5.
- 5.3.4. Minimum values for the coefficient of retro-reflection
- Photometric specifications for advance warning triangles of Types 1 and 2.
- 5.3.4.1. When measured as described in paragraph 5.3.4.1.1. and Part 1 of Annex 4, the R_1 values of the entire red retro-reflective area in new condition shall be at least as indicated in Table 14.
- 5.3.4.1.1. For this measurement it is assumed that the direction of illumination $\beta_1 = \beta_2 = \Theta$ for the advance warning triangle in its position of use is parallel to the base plane and vertical to the lower side of the triangle, which in turn is parallel to the said base plane.
- 5.3.4.2. Retro-reflective devices and fluorescent retro-reflecting material.

Table 8
Minimum values for the R_1

	<i>Illumination angles β in deg.</i>			
	0°	$\pm 20^\circ$	0°	0°
Vertical β_1	0°	$\pm 20^\circ$	0°	0°
Horizontal β_2	0° or $\pm 5^\circ$	0°	$\pm 30^\circ$	$\pm 40^\circ$
	<i>Minimum values in $\text{mcd}\cdot\text{lx}^{-1}$</i>			
Angles of divergence $20'$	$8.00\cdot 10^3$	$4.00\cdot 10^3$	$1.70\cdot 10^3$	$6.00\cdot 10^2$
Angles of divergence $1^\circ 30'$	$6.00\cdot 10^2$	$2.00\cdot 10^2$	$1.00\cdot 10^2$	$5.0\cdot 10^1$

- 5.3.4.2.1. The R_1 measured on random slices of 50 mm length of the retro-reflective device shall lie between extremes having a ratio not in excess of 3. These slices are taken between the perpendiculars to the side of the triangle and passing through the corresponding apexes of the central aperture. This requirement applies to an angle of divergence of $20'$ and to illumination angles of $\beta_1 = 0^\circ$, $\beta_2 = 0^\circ$ or $\pm 5^\circ$ and $\beta_1 = \pm 20^\circ$, $\beta_2 = 0^\circ$.
- 5.3.4.2.2. Diversity of luminance at angles of illumination of V $\beta_1 = 0^\circ$, H $\beta_2 = \pm 30^\circ$, and $\beta_1 = 0^\circ$, $\beta_2 = \pm 40^\circ$ shall be tolerated on condition that the triangular shape remains clearly discernible, for an angle of divergence of $20'$ and an illumination of approximately 1 lux.
- 5.3.4.2.3. The measurements referred to above shall be performed by the method described in Part 1 of Annex 4.
- 5.3.5. Colorimetric specification

- 5.3.5.1. Retro-reflective devices
- 5.3.5.1.1. Retro-reflective devices shall be made of material coloured red in the mass.
- 5.3.5.1.2. The testing of the colour for retro-reflective device (night-time colour) shall be carried out according to the method described in paragraph 4.2.1. and the trichromatic co-ordinates of the red reflected luminous flux shall be within the following limits:

Table 9

Colour coordinates for retro-reflective device (night-time colour)

<i>Point</i>	<i>1</i>	<i>2</i>	<i>3</i>	<i>4</i>
<i>x</i>	0.712	0.735	0.589	0.625
<i>y</i>	0.258	0.265	0.376	0.375

- 5.3.5.2. Fluorescent materials
- 5.3.5.2.1. The fluorescent materials shall either be coloured in the mass or take the form of separate coatings applied to the surface of the triangle.
- 5.3.5.2.2. The testing of the colour of the fluorescent materials (daytime colour) of advance warning triangle of type 1 or type 2 shall be carried out according to the method described in paragraph 4.2.2. and the colour of the material in new condition shall be within an area of which the corner points are determined by the following coordinates as specified in Table 10:

Table 10

Colour coordinates of the fluorescent materials (daytime colour)

<i>Point</i>	<i>1</i>	<i>2</i>	<i>3</i>	<i>4</i>
<i>x</i>	0.570	0.506	0.595	0.690
<i>y</i>	0.430	0.404	0.315	0.310

- 5.3.5.2.3. The testing of the luminance factor of the fluorescent materials shall be carried out according to the method described in Part 6 of Annex 6.

The luminance factor, including the luminance by reflection and fluorescence, shall be:

- (a) For advance warning triangle of type 1, $\beta_{v,R} \geq 0.3$; and
- (b) For advance warning triangle of type 2, $\beta_{v,R} \geq 0.25$.
- 5.3.5.3. The largest measured trichromatic coordinate *y* value according to paragraph 4.2.1. (night time colour) shall be smaller or equal to the largest measured trichromatic coordinate *y* value according to paragraph 4.2.2. (daytime colour).
- 5.3.5.4. Requirements after weathering
- When tested according to Part 6 of Annex 6, the following conditions shall be fulfilled:
- 5.3.5.4.1. After the test, the colour co-ordinates of the fluorescent material shall comply with colour specification in paragraph 5.3.5.2.2. The luminance factor (see paragraph 4.3.) shall comply with paragraph 5.3.5.2.3. and shall not have increased by more than 0.05.
- 5.3.5.4.2. The sample shall not exhibit any visible damage such as cracks, scaling or peeling of the fluorescent or of the fluorescent retro-reflecting material. If the fluorescent material is an adhesive film which had already successfully passed

the tests of paragraph 5.3.7.1.7. in a previous approval test, the test need not be repeated; a corresponding note shall be entered under item 9 ("Remarks") in the communication concerning approval (Annex 1).

- 5.3.6. Special specification (tests) / resistance to external agents
- 5.3.6.1. Resistance to weathering
A specimen shall be subjected to a test as specified in Part 6 of Annex 6.
- 5.3.6.2. Resistance to fuels
A specimen of the sample unit shall be subjected to a test as specified in Part 1 of Annex 7.
- 5.3.6.3. Resistance to heat
A specimen of the sample unit shall be subjected to a test as specified in Annex 9.
- 5.3.6.4. Resistance to penetration of water
A specimen of the sample unit shall be subjected to a test as specified in Part 2 of Annex 6.
- 5.3.6.5. Wind test
A specimen of a complete plate shall be subjected to a test of rigidity of plates as specified in Annex 9.
- 5.3.6.6. Test of clearance to ground
A specimen of the sample unit shall be subjected to a test as specified in Annex 9.
- 5.3.7. Chronological order
- 5.3.7.1. General
- 5.3.7.1.1. The applicant shall submit samples, as mentioned in paragraph 3.1., for approval.
- 5.3.7.1.2. After verification of the general specifications in paragraph 4. and the specifications of the shape and the dimensions identified in Figure A5-VIII or Figure A5-IX, all samples shall be subjected to the heat resistance test in Annex 9 and examined after at least one hour of rest.
- 5.3.7.1.3. The R_1 value of the four samples of the advance warning triangles submitted is measured at an observation angle of 20' and at an illumination angle with the components $\beta_1 = 0^\circ$, $\beta_2 = \pm 5^\circ$; this test is carried out in accordance with the method described in paragraph 4.
- 5.3.7.1.4. The two samples with the smallest and the largest R_1 value in the tests according to paragraph 5.9.7.1.3. shall be subsequently subjected to the following tests:
- 5.3.7.1.4.1. Measurement of the values of the R_1 in respect of the observation and illumination angles referred to in paragraph 5.3.4. according to the method described in paragraph 4.
- 5.3.7.1.4.2. Testing of the colour of the retro-reflected light according to paragraph 4.2. on the sample with the highest R_1 concerned shall be examined.
- 5.3.7.1.4.3. Test of clearance to ground according to Annex 9 paragraph 1.
- 5.3.7.1.4.4. Mechanical solidity test according to Annex 9 paragraph 2.
- 5.3.7.1.5. One sample other than those referred to in paragraph 5.3.7.1.4. shall be subjected to the following tests:

- 5.3.7.1.5.1. Testing of resistance to penetration of water into the retro-reflective device according to Part 2 of Annex 6 or if relevant, of the mirror-backed reverse side of the retro-reflective device, according to Part 5 of Annex 6.
- 5.3.7.1.6. The second sample, other than those referred to in paragraph 5.3.7.1.4., shall be subjected to the following tests:
 - 5.3.7.1.6.1. Water test according to Part 2 of Annex 6.
 - 5.3.7.1.6.2. Testing of resistance to fuels according to Part 1 of Annex 7.
 - 5.3.7.1.6.3. Test of stability against wind according to Annex 9.
- 5.3.7.1.7. After the tests specified in paragraph 5.3.7.1.4., the two samples submitted according to paragraph 3.1. shall be subjected to the following tests:
 - 5.3.7.1.7.1. Colour test according to paragraph 4.2.;
 - 5.3.7.1.7.2. Test of the luminance factor according to paragraph 4.3.;
 - 5.3.7.1.7.3. Test of resistance to weathering according to Part 6 of Annex 6.
 - 5.3.7.1.7.3.1. After the test, the colour co-ordinates of the fluorescent material shall comply with colour specification in paragraph 5.3.5.2.2. of this Regulation. The luminance factor (see paragraph 4.3.) shall comply with paragraph 5.3.5.2.3. above of this Regulation and shall not have increased by more than 5 per cent compared with the value ascertained according to paragraph 5.3.7.1.7.2. above.
 - 5.3.7.1.7.3.2. The sample shall not exhibit any visible damage such as cracks, scaling or peeling of the fluorescent or of the fluorescent retro-reflecting material. If the fluorescent material is an adhesive film which had already successfully passed the tests of paragraph 5.3.7.1.7. in a previous approval test, the test need not be repeated; a corresponding note shall be entered under item 9. ("Remarks") in the communication concerning approval (Annex 1 to this Regulation).

6. Transitional provisions

6.1 General

- 6.1.1. Contracting Parties applying this Regulation shall continue to accept type approvals of the devices, to any of the preceding series of amendments to this Regulation, which are not affected by the changes introduced by the latest series of amendments.

To verify this, the change index applicable to the pertinent device shall not differ from its change index as indicated in the latest series of amendments.

- 6.1.2. Contracting Parties applying this Regulation shall not refuse to grant extensions to type approvals according to any preceding series of amendments to this Regulation.

6.2 For the 01 series of amendments

- 6.2.1. As from the official date of entry into force of the 01 series of amendments, no Contracting Party applying this Regulation shall refuse to grant or refuse to accept UN type approvals under this Regulation as amended by the 01 series of amendments.
- 6.2.2. As from 1 September 2026 Contracting Parties applying this Regulation shall not be obliged to accept UN type approvals to the preceding series of amendments, first issued after 1 September 2026.
- 6.2.3. Contracting Parties applying this Regulation shall continue to accept type approvals to the preceding series of amendments to this Regulation, first issued before 1 September 2026.

- 6.2.4. Contracting Parties applying this Regulation shall continue to grant and accept type approvals for devices (equipment and parts) on the basis of any previous series of amendments, provided that the devices (equipment and parts) are intended as replacements for fitting to vehicles in use and that it is not technically feasible for the devices (equipment and parts) in question to satisfy the new requirements contained in this Regulation as amended by the 01 series of amendments.
- 6.2.5. Notwithstanding the transitional provisions above, Contracting Parties whose application of this Regulation comes into force after the date of entry into force of the 01 series of amendments are not obliged to accept UN type approvals which were granted in accordance with any of the preceding series of amendments to this Regulation.
- 6.2.6. Contracting Parties applying this Regulation shall continue to accept UN type approvals to the preceding series of amendments to this Regulation, for the equipment or parts which are not affected by the changes introduced by the 01 series of amendments.
- 6.2.7. Contracting Parties applying this Regulation shall not refuse to grant type approvals according to any preceding series of amendments to this Regulation or extensions thereof.

Annex 1

Communication

(Maximum format: A4 (210 x 297 mm))



issued by: Name of administration:
.....
.....
.....

concerning:² Approval
Approval extended
Approval refused
Approval withdrawn
Production definitively discontinued

of a type of retro-reflective device
of a type of advance warning triangle
of a type of SMV rear marking plate
of a type of rear marking plate,
of retro-reflective markings of heavy and long vehicles and their trailers pursuant to UN Regulation No. 150

Class of the device: Change index:

Approval No:

Unique Identifier (UI) (If applicable):

1. Trade name or mark of the retro-reflective device or marking material:
.....
2. Manufacturer's name:
- 2.1. for the retro-reflecting type of device:.....
- 2.2. for the advance warning triangle
- 2.3. for the SMV rear marking plate type:.....
- 2.3.1. SMV rear marking plate class:
- 2.4. for the rear marking plate type:
- 2.4.1. Rear marking plate class:
- 2.5. Class of the marking material:.....
3. Name and address of the manufacturer:
4. If applicable, name and address of manufacturer's representative:

¹ Distinguishing number of the country which has granted/extended/refused/withdrawn approval (see approval provisions in the Regulation).

² Strike out what does not apply.

5. Date on which the marking material was submitted for approval tests:
6. Technical service responsible for carrying out the approval test:
7. Date of test report issued by the technical service:.....
8. Number of test report issued by the technical service:
9. Remarks:
10. Position of the approval mark or Unique Identifier (UI)
11. Approval granted/refused/extended/withdrawn²
12. Reason(s) for the extension (if applicable):.....
.....
13. Place:
14. Date:
15. Signature:
- Name:
16. Annexed is a list of documents making up the approval file, deposited with the Type Approval Authority which granted approval; a copy can be obtained on request.

Annex 2

Minimum requirements for conformity of production control procedures

1. General
 - 1.1. The conformity requirements shall be considered satisfied from a mechanical and geometric standpoint, if the differences do not exceed inevitable manufacturing deviations within the requirements of this Regulation.
 - 1.2. With respect to photometric performances, the conformity of mass-produced retro-reflective devices shall not be contested if, when testing photometric performances of any retro-reflective device chosen at random no measured value deviates unfavourably by more than 20 per cent from the minimum values prescribed in this Regulation.
 - 1.3. The chromaticity coordinates shall be complied with.
2. Minimum requirements for verification of conformity by the manufacturer

For each type of retro-reflective device the holder of the approval mark shall carry out at least the following tests, at appropriate intervals. The tests shall be carried out in accordance with the provisions of this Regulation.

If any sampling shows non-conformity with regard to the type of test concerned, further samples shall be taken and tested. The manufacturer shall take steps to ensure the conformity of the production concerned.

 - 2.1. Nature of tests

Tests of conformity in this Regulation shall cover the photometric and colorimetric characteristics and the resistance to penetration of water.
 - 2.2. Methods used in tests
 - 2.2.1. Tests shall generally be carried out in accordance with the methods set out in this Regulation.
 - 2.2.2. In any test of conformity carried out by the manufacturer, equivalent methods may be used with the consent of the Type Approval Authority. The manufacturer is responsible for proving that the applied methods are equivalent to those laid down in this Regulation.
 - 2.2.3. The application of paragraphs 2.2.1. and 2.2.2. requires regular calibration of test apparatus and its correlation with measurements made by a Type Approval Authority.
 - 2.2.4. In all cases the reference methods shall be those of this Regulation, particularly for the purpose of administrative verification and sampling.
 - 2.3. Nature of sampling

Samples of retro-reflective devices shall be selected at random from the production of a uniform batch. A uniform batch means a set of retro-reflective devices of the same type, defined according to the production methods of the manufacturer.

The assessment shall in general cover series production from individual factories. However, a manufacturer may group together records concerning the same type from several factories, provided these operate under the same quality system and quality management.
 - 2.4. Measured and recorded photometric characteristics

The sampled retro-reflective device shall be subjected to photometric measurements at the points and the chromaticity coordinates provided for in the Regulation.

2.5. Criteria governing acceptability

The manufacturer is responsible for carrying out a statistical study of the test results and for defining, in agreement with the Type Approval Authority, criteria governing the acceptability of his products in order to meet the specifications laid down for the verification of conformity of products in paragraph 3.5.1. of this Regulation. The criteria governing the acceptability shall be such that, with a confidence level of 95 per cent, the minimum probability of passing a spot check in accordance with Annex 3 (first sampling) would be 0.95.

Annex 3

Minimum requirements for sampling by an inspector

1. General
 - 1.1. The conformity requirements shall be considered satisfied from a mechanical and a geometric standpoint, in accordance with the requirements of this Regulation, if any, if the differences do not exceed inevitable manufacturing deviations.
 - 1.2. With respect to photometric performance, the conformity of mass-produced retro-reflective devices shall not be contested if, when testing photometric performances of any retro-reflective device chosen at random:
 - 1.2.1. No measured value deviates unfavourably by more than 20 per cent from the minimum values prescribed in this Regulation.
 - 1.2.2. Retro-reflective devices with apparent defects are disregarded.
 - 1.3. The chromaticity coordinates shall be complied with.
2. First sampling

In the first sampling four retro-reflective devices are selected at random. The first sample of two is marked A, the second sample of two is marked B.

 - 2.1. The conformity of mass-produced retro-reflective devices shall not be contested if the deviation of any specimen of samples A and B (all four retro-reflective devices) is not more than 20 per cent.

In the case, that the deviation of both retro-reflective devices of sample A is not more than 0 per cent, the measurement can be closed.
 - 2.2. The conformity of mass-produced retro-reflective devices shall be contested if the deviation of at least one specimen of samples A or B is more than 20 per cent.

The manufacturer shall be requested to bring his production in line with the requirements (alignment) and a repeated sampling according to paragraph 3. below shall be carried out within two months' time after the notification. The samples A and B shall be retained by the Technical Service until the entire CoP process is finished.
3. First repeated sampling

A sample of four retro-reflective devices is selected at random from stock manufactured after alignment-

The first sample of two is marked C, the second sample of two is marked D.

 - 3.1. The conformity of mass-produced retro-reflective devices shall not be contested if the deviation of any specimen of samples C and D (all four retro-reflective devices) is not more than 20 per cent.

In the case, that the deviation of both retro-reflective devices of sample C is not more than 0 per cent, the measurement can be closed.
 - 3.2. The conformity of mass-produced retro-reflective devices shall be contested if the deviation of at least:
 - 3.2.1. One specimen of samples C or D is more than 20 per cent but the deviation of all specimens of these samples is not more than 30 per cent.

The manufacturer shall be requested again to bring his production in line with the requirements (alignment).

A second repeated sampling according to paragraph 4. shall be carried out within two months' time after the notification. The samples C and D shall be retained by the Technical Service until the entire CoP process is finished.

- 3.2.2. One specimen of samples C and D is more than 30 per cent:
In this case the approval shall be withdrawn and paragraph 5. shall be applied.
4. Second repeated sampling
A sample of four retro-reflective devices is selected at random from stock manufactured after alignment.
The first sample of two is marked E, the second sample of two is marked F.
- 4.1. The conformity of mass-produced retro-reflective devices shall not be contested if the deviation of any specimen of samples E and F (all four retro-reflective devices) is not more than 20 per cent. In the case, that the deviation of both retro-reflective devices of sample E is not more than 0 per cent the measurement can be closed.
- 4.2. The conformity of mass-produced retro-reflective devices shall be contested if the deviation of at least one specimen of samples E or F is more than 20 per cent.
In this case the approval shall be withdrawn and paragraph 5. shall be applied.
5. Approval withdrawn
Approval shall be withdrawn according to paragraph 3.6. of this Regulation.
6. Resistance to water penetration
- 6.1. One of the retro-reflectors of sample A after the sampling procedure in paragraph 2. shall be tested according to the procedure described in paragraph 1. of Part 2 of Annex 6 or, in the case of the Advance Warning Triangle, the sample A shall be tested according to the procedure described in paragraph 2. of Part 2 of Annex 6.
The retro-reflectors shall be considered as acceptable if the test has been passed. However, if the test on sample A is not complied with, the two retro-reflective devices of sample B shall be subjected to the same procedure, and both shall pass the test.
- 6.2. Specimens of one of the rear marking plates of sample A after the sampling procedure in paragraph 2., shall be tested according to the procedures described in Annexes 6, 7, 9, 11, 13, 15, 16 and 18 to this Regulation.
The rear marking plate shall be considered acceptable if the tests were passed.
However, if the tests on specimens of sample A did not pass the tests, the two rear marking plates of sample B shall be subjected to the same procedure and both shall pass the test.

Annex 4

Photometric and colorimetric measurements

Part 1 - Photometric measurements of retro-reflective devices

1. Test procedures
 - 1.1. When the R_1 of a retro-reflective device is measured for an angle β of $\beta_1 = \beta_2 = 0^\circ$, it shall be ascertained whether any mirror effect is produced by slightly turning the device. If there is any such effect, a reading shall be taken with an angle β of $\beta_1 = \pm 5^\circ$, $\beta_2 = 0^\circ$. The position adopted shall be that corresponding to the minimum R_1 for one of these positions.
 - 1.2. With an illumination angle β of $\beta_1 = \beta_2 = 0^\circ$, or the angle specified in paragraph 5. of this Regulation, and an angle of divergence of $20'$, retro-reflective devices which are not marked "TOP" shall be rotated about their axes of reference to the position of minimum R_1 , which must conform to the value specified in paragraph 5. of this Regulation. When the R_1 is measured for the other angles of illumination and divergence, the retro-reflective device shall be placed in the position corresponding to this value of ε . If the specified values are not attained, the device may be rotated about its axis of reference $\pm 5^\circ$ from that position.
 - 1.3. With an illumination angle β of $\beta_1 = \beta_2 = 0^\circ$, or the angle specified in paragraph 4. of this Regulation, and an angle of divergence of $20'$, retro-reflective devices marked "TOP" shall be rotated about their axes $\pm 5^\circ$. The R_1 must not fall below the prescribed value in any position assumed by the device during this rotation.
 - 1.4. If for the direction $\beta_1 = \beta_2 = 0^\circ$, and for $\varepsilon = 0^\circ$ the R_1 exceeds the specified value by 50 per cent or more, all measurements for all angles of illumination and divergence shall be made for $\varepsilon = 0^\circ$.

2. Definitions

Basic definitions are given in paragraph 2.3. of this Regulation. Further definitions and geometry parameters are listed below and are illustrated in Figures A4-I to A4-III.

C Reference centre, e.g. a point on a retro-reflective area which is designated to be the centre of the device for the purpose of specifying its performance and mounting on the goniophoto-meter.

I Illumination axis, e.g. the line passing through the centre of the light source and the reference centre.

O Observation axis, e.g. the line connecting the reference centre and the centre of the photometer head.

α Observation angle, e.g. the angle between the illumination axis and the observation axis.

NOTE This angle is sometimes called angle of divergence.

β_1/β_2 Entrance angle, e.g. the angle between the reference axis and the illumination axis. The illumination angle consists of a vertical component (symbol β_1) and a horizontal component (symbol β_2). For any direction the vertical angle is always given first.

NOTE 1: These angles are usually not larger than 90° but, for completeness, the full range is defined as

$-90^\circ < \beta_1 < 90^\circ$ and

$$-180^\circ < \beta_2 < 180^\circ.$$

NOTE 2: The entrance angle is sometimes as well referred to as illumination angle.

ε Angle of rotation means the angle through which the retro-reflecting device is rotated about its axis of reference starting from a given position. If the retro-reflecting device is marked "TOP" (e.g. the datum mark), the indicated position is taken as the origin.

γ Angular aperture of the measuring device, i.e. the angle subtended by the largest dimension of the receiver as seen from the reference centre ($\beta_1 = \beta_2 = 0^\circ$).

δ Angular aperture of the source as seen from the reference centre

η Angular aperture of the retro-reflecting device, e.g. the angle subtended by the largest dimension of the visible area of the illuminating surface, either at the centre of the source of illumination or at the centre of the receiver.

3. Dimensional and physical specifications for the photometry of retro-reflective devices
- 3.1. The CIE-angular system as shown in Figure A4-I shall be used for specifying and measuring retro-reflective device and marking materials.

Figure A4-I
The CIE co-ordinate system

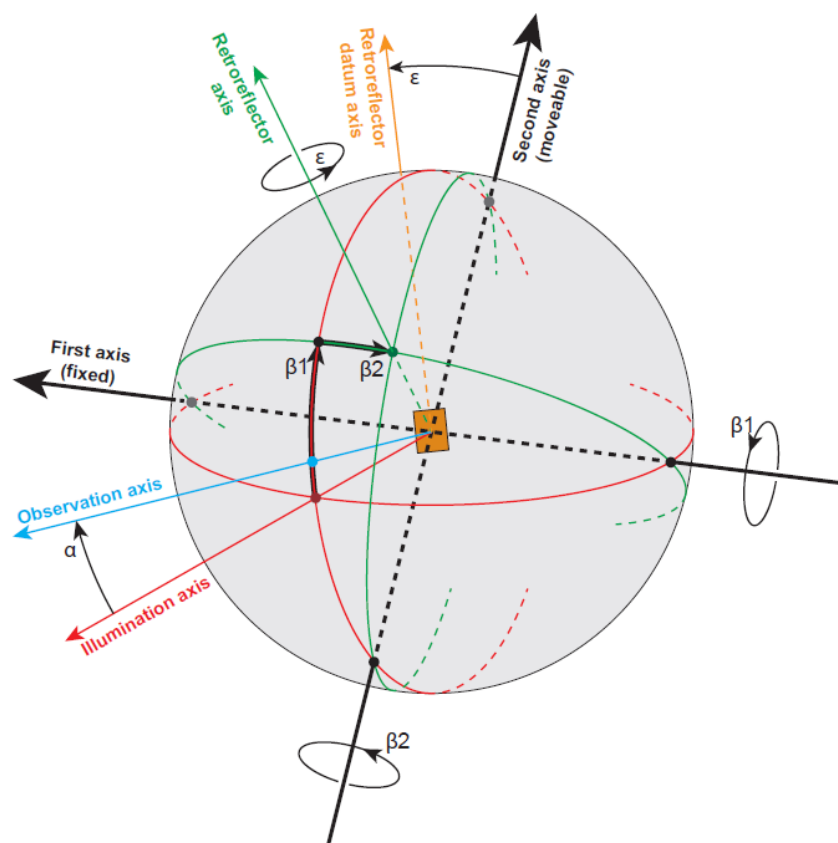

- 3.2. An adequate support (goniometer) is demonstrated in Figure A4-II. It represents a goniometer mechanism embodying the CIE angular system for specifying and measuring retro-reflective device and marking materials. All axes, angles, and directions of rotation are shown positive.

Notes:

- (a) The principal axis is given by the illumination axis;
- (b) The first axis is fixed perpendicular to the plane containing the observation and illumination axis; the second axis is perpendicular both to the first axis and to the reference axis.
- (c) The reference axis is fixed in the retro-reflective device and moved with β_1 and β_2 . Its rotation is given by ε .

Figure A4-II

Goniometer mechanism embodying the CIE angular system

Any arrangement of the components which is equivalent to the one shown can be used.

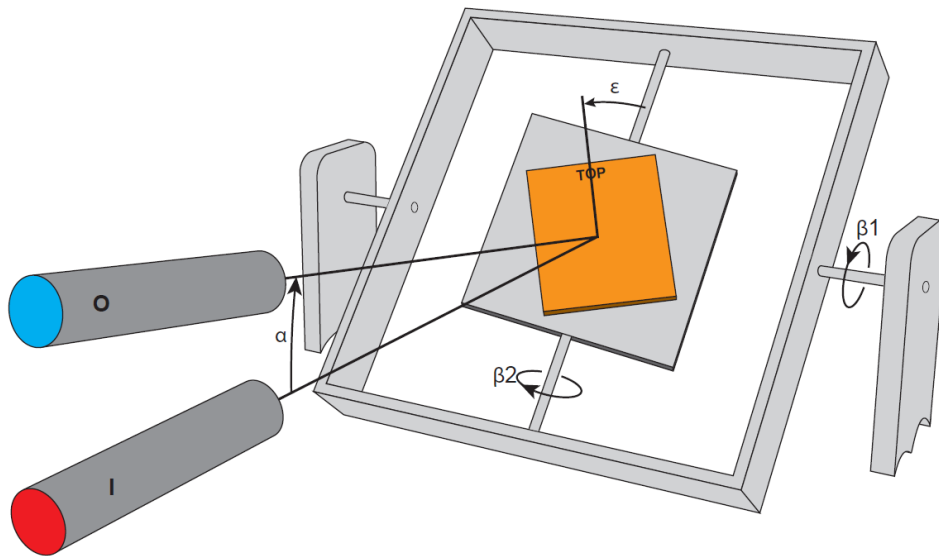

3.3. For testing the retro-reflection the retro-reflective devices shall be illuminated with a CIE Standard Illuminant A (ISO 11664-2:2007(E)/CIE S 014-2/E:2006) and measured as described in Part 1 of Annex 4.

3.4. The measuring geometry is described in Figure A4-III. The following limits apply:

Angular diameter of the source -	$\delta \leq 10'$
Angular diameter of the measuring device -	$\gamma \leq 10'$
Angular diameter of the illuminated area -	$\eta \leq 80'$

Figure A4-III
Measuring geometry for the measurement of retro-reflective devices

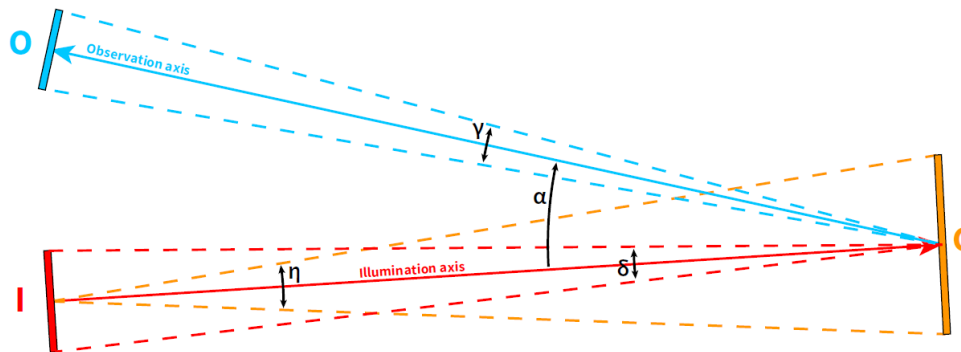

- 3.5. During photometric measurements, stray reflections should be avoided by appropriate masking.
- 3.6. The measuring distance shall be chosen in such an order that at least the limits for the angles δ , γ and η given above and illustrated in Figure A4-III are respected, but not lower than 10 m.
- 3.7. The illuminance over the useful area of the retro-reflective device, measured perpendicular to the incident light shall be sufficiently uniform. A check on this condition requires a measuring element, the sensitive area of which is not greater than one-tenth of the area to be examined. The variation in the value of the illuminance shall then comply with the condition:

$$\max/\min \leq 1.05$$

- 3.8. The photometer head (measuring element)
- 3.8.1. The photometer head shall be corrected to the spectral luminous efficiency for the CIE standard photometric observer in photopic vision.
- 3.8.2. The device shall not show a perceptible change in local sensitivity within the area of its aperture; otherwise suitable provisions shall be added, e.g. the application of a diffusing window at a certain distance in front of the sensitive surface.
4. Measurement precautions in the photometry of retro-reflection
- Best practice procedures are described in the relevant CIE reports and standards, however, items to be considered are briefly outlined below.
- 4.1. Residual and stray light
- 4.1.1. Since very low light levels are to be measured, special precautions are needed to minimize errors due to stray light. The background to the sample and the framework of the sample holder should be matt black and the field of view of the photometer head and the spread of light from both the sample and the source shall be restricted as much as possible.
- 4.1.2. Reflections from the floor and walls which occur over the relatively long test distances used shall be screened from both the sample and the photometer head by baffles.
- 4.1.3. Correction of residual stray light should always be allowed for by measuring it when the sample is covered by an opaque matt black surface, zigzag folded black paper of the same size and shape or a specular black surface suitably oriented with a light trap. This value shall be subtracted from that measured on the retro-reflective device
- 4.2. Stability of the apparatus

- 4.2.1. The light source and photometer head should remain stable throughout the period of the test. Since the sensitivity and the adaptation to the $V(\lambda)$ function of most photometer heads change with temperature, the laboratory ambient temperature should not vary significantly during this period. Sufficient time should always be allowed for the apparatus to stabilize before commencing measurements.
- 4.2.2. A useful check on the overall stability of the reflex photometer during a series of tests is to make periodic measurements of R_1 values of a stable reference standard.
- 4.3. Description of Goniometer
- A goniometer as defined in paragraph 2.3. of this Regulation, which can be used in making retro-reflection measurements in the CIE geometry is illustrated in Figure A4-II. In this illustration, the photometer head (O) is arbitrarily shown to be vertically above the source (I). The first axis is shown to be fixed and horizontal and is situated perpendicular to the observation half-plane. Any arrangement of the components which is equivalent to the one shown can be used.

Part 2 - Description of the measurement geometry for measurement of the daytime colour and the luminance factor of retro-reflective material

For testing the daytime colour and luminance factor of the material, illumination by CIE Standard Illuminant D65 (ISO 11664-2:2007(E)/CIE S 014-2/E:2006) using geometry (45a:0) shall be used.

1. Measurement of daytime Colour

Measurements shall be done with a spectrophotometer in accordance with the provisions of Publication CIE 15:2004, Recommendations on Colorimetry - Second Edition, either illuminated poly-chromatically or with a monochromator providing stepwise the CIE Standard Illuminant D65 (ISO 11664-2:2007(E)/CIE S 014-2/E:2006) at an angle 45° to the normal and viewed along the normal (geometry 45/0). In the latter case, the stepwise resolution $\Delta\lambda$ shall be not larger than 10 nm. Alternatively, similar simulation spectra are allowed, if verified that the colorimetric measuring procedure is of the same accuracy, meaning that the quality of the D65 simulation shall be assessed by the method described in ISO 23603:2005(E)/CIE S 012/E:2004. The spectral distribution of the Illuminant shall be in category BC (CIELAB) or better.

The measurement area shall be at least minimum 4.0 cm².

Micro-prismatic materials show the phenomenon of "flares" or "sparkles" (Note 1), which might influence the measured results unless special precautions as outlined above are taken.

For this geometry CIE 15 recommends that:

- (a) The sampling aperture be irradiated uniformly from all directions between two circular cones with their axes normal to the sampling aperture and apices at the centre of the sampling aperture, the smaller of the cones having a half angle of 40° and the larger of 50° .
- (b) The receiver uniformly collects and evaluates all radiation reflected within a cone with its axis on the normal to the sampling aperture, apex at the centre of the sampling aperture, and a half angle of 5° .

The annular geometry can be approximated by the use of a number of light sources in a ring or a number of fibre bundles illuminated by a single source and terminated in a ring to obtain the CIE 45°a:0° (annular / normal geometry) (Note 2, Note 3).

An alternative manner of approximation is to use a single light source, but rotate the sample during measurement with a rotational speed that ensures that a number of revolutions takes

place during the exposure time interval for a measurement so that all circumferential angles are given equal weight (Note 2, Note 3).

In addition, the apertures of the light source and the receiver shall have sufficient dimensions in proportion to distances to ensure compliance with the above-mentioned recommendations.

Note 1: "Flares" or "sparkles" are caused by characteristic paths of rays that enter and leave the material surface at different angles. A characteristic path will dominate thus raising the luminance factor value significantly and possibly distorting the chromaticity co-ordinates if it is included within narrow beams of illumination and measurement. However, the average contribution to the daylight reflection is normally small.

Note 2: In practice the recommendations can be approximated only. The important fact is that the annular principle is applied and that illumination and collection occur in specified directions using solid angles as specified in a) and b), as this will reduce the influence of above-mentioned "sparkles" of micro-prismatic materials and of other variations within the geometry shown by some of these materials.

Note 3: In spite of such precautions, the practical difficulties of establishing the annular geometry in accordance with the recommendations introduce an uncertainty of measurement.

2. Determination of luminance factor

By putting the luminance L of the sample into relation to the luminance L_0 of a perfect diffuser whose luminance factor is known under identical conditions of illumination and observation; the luminance factor $\beta_{v,R}$ of the sample then results from the formula:

$$\beta_{v,R} = \frac{L}{L_0}$$

In case the colour of the fluorescent material has been colorimetrically determined in compliance with paragraph 1 above, the luminance factor $\beta_{v,R}$ can be determined by the ratio of the tristimulus value Y of the sample and of the tristimulus value Y_0 of the perfect diffuser:

$$\beta_{v,R} = \frac{Y}{Y_0}$$

Part 3 - Stability of photometric properties

1. The approval granting authority has the right to test the optical properties stability of a retro-reflecting material in use (when used for marking or as distinctive markings/graphics).
2. The Type Approval Authorities of Contracting Parties, in which the approval was granted, may undertake the same tests. If "systematic failures in use" occur for a type of retro-reflective material, the tested material samples shall be transferred for appraisal to the authority which granted approval.
3. If other criteria are missing, the notation "systematic failures in use" for a type of retro-reflective material is to be established according to paragraph 5 in Part 3 of Annex 4.
4. The authority which granted approval shall have the right to check the stability in time of the optical properties of a type of rear marking plate in service.
5. The Type Approval Authorities of countries other than the country in which approval was granted may carry out similar checks in their territory. If a type of rear marking plate in use exhibits a systematic defect, the said authorities shall transmit to the authority which granted approval, with a request for its opinion, any components removed for examination.
6. In the absence of other criteria, the concept of "systematic defect" of a type of rear marking plate in use shall be interpreted in conformity with the intention of paragraph 5. of Part 3 of Annex 4.

Annex 5

Specifications of shape and dimensions

1. Shape and dimensions of retro-reflective devices of Class IA or IB
 - 1.1. The shape of the illuminating surfaces shall not be easily confused with the triangular shape, as prescribed for retro-reflectors mentioned in paragraph 2.1., from an observation distance of 10 metres.
2. Shape and dimensions of retro-reflective devices of Classes IIIA and IIIB
 - 2.1. The illuminating surfaces of retro-reflective devices of Classes IIIA and IIIB must have the shape of an equilateral triangle. If the word "TOP" is inscribed in one corner, the apex of that corner must be directed upwards.
 - 2.2. The illuminating surface may or may not have at its centre a triangular, non-retro-reflecting area, with sides parallel to those of the outer triangle.
 - 2.3. The illuminating surface may or may not be continuous. In any case, the shortest distance between two adjacent retro-reflecting optical units must not exceed 15 mm.
 - 2.4. The illuminating surface of a retro-reflective device shall be considered to be continuous if the edges of the illuminating surfaces of adjacent separate optical units are parallel and if the said optical units are evenly distributed over the whole solid surface of the triangle.
 - 2.5. If the illuminated surface is not continuous, the number of separate retro-reflecting optical units including the corner units shall not be less than four on each side of the triangle.
 - 2.5.1. The separate retro-reflecting optical units shall not be replaceable unless they consist of approved retro-reflective devices of Class IA.
 - 2.6. The outside edges of the illuminating surfaces of triangular retro-reflective devices of Classes IIIA and IIIB shall be between 150 and 200 mm long. In the case of devices of hollow-triangle type, the width of the sides, measured at right angles to the latter, shall be equal to at least 20 per cent of the effective length between the extremities of the illuminating surface.
3. Shape and dimensions of retro-reflective devices of Class IVA
 - 3.1. The shape of the light emitting surfaces shall not be easily confused with the triangular shape, as prescribed for retro-reflectors mentioned in paragraph 2.1., from an observation distance of 10 metres.
 - 3.2. The light emitting surface of the retro-reflective device must be at least 25 cm².
 - 3.3. Compliance with the above specifications shall be verified by visual inspection.

Figure A5-I
Retro-reflectors for trailers – Classes IIIA and IIIB

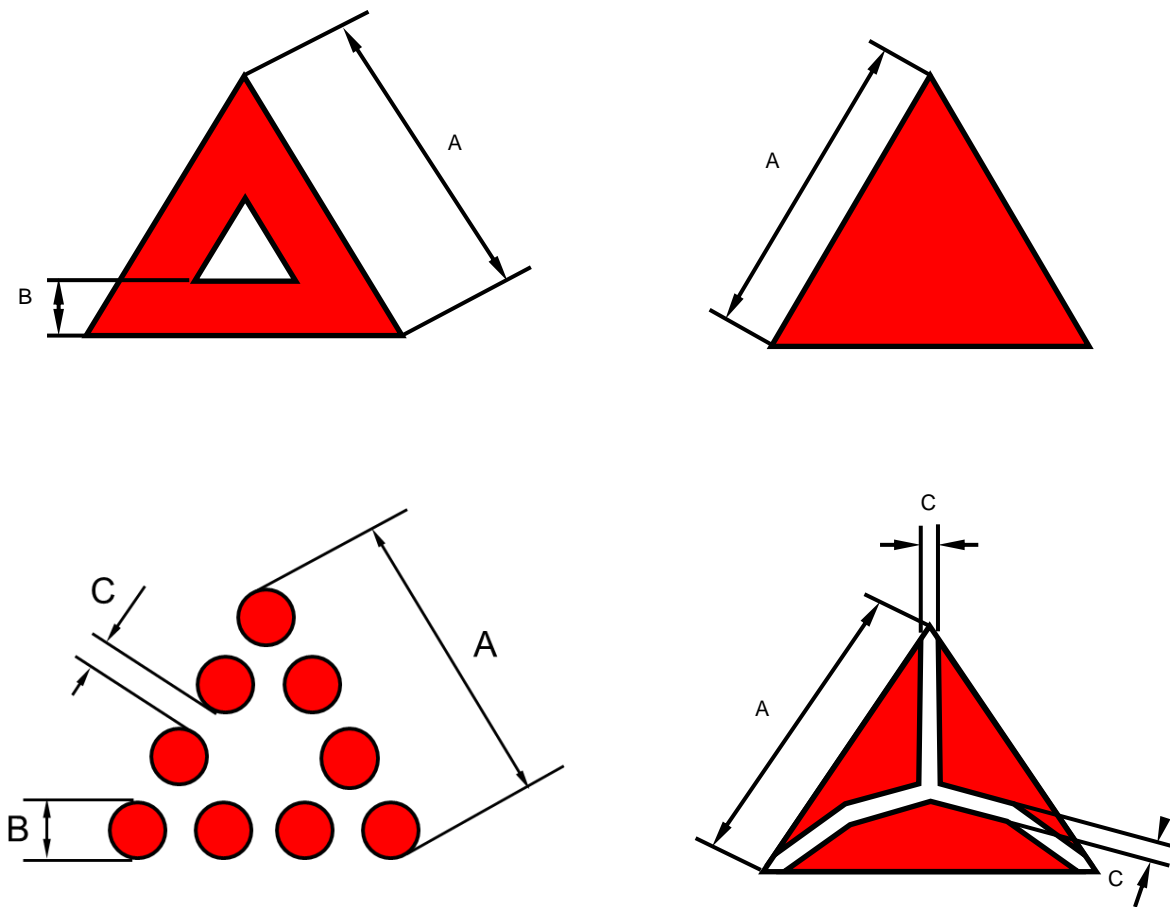

$$150 \text{ mm} \leq A \leq 200 \text{ mm}$$

$$B \geq \frac{A}{5}$$

$$C \leq 15 \text{ mm}$$

Note: These sketches are for illustration purposes only.

4. Shape and dimensions of retro-reflective marking materials of Class C
 - 4.1. General

The markings shall be made of strips of retro-reflective material.
 - 4.2. Dimensions
 - 4.2.1. The width of a retro-reflective marking material shall be $50 \text{ mm} \begin{smallmatrix} +10 \\ -0 \end{smallmatrix} \text{ mm}$.
 - 4.2.2. The minimum length of an element of a retro-reflective marking material shall be such that at least one approval mark is visible.
5. Shape and dimensions of retro-reflective marking materials of Class F or marking plates of Class 5

5.1. General

The markings shall be made of strips of retro-reflective material or plates.

5.2. Dimensions

5.2.1. Class F and Class 5 retro-reflective markings shall consist of red and white diagonal stripes downwards at $45^\circ \pm 1^\circ$ as shown in Figures A5-II, A5-III and A5-IV respectively. The basic standard area is a square of $141 \text{ mm} \pm 1 \text{ mm}$ in length subdivided diagonally into a white half and red half, which represents one standard area as shown in Figure A5-II.

5.2.2. The minimum length of an element of a retro-reflective marking material or plate shall incorporate a minimum of 9 standard areas as described in paragraph 5.2.1. on large vehicles with available mounting space, but may be reduced to a minimum of 3 standard areas on vehicles with limited mounting space.

Figure A5-II

Retro-reflective material marking of Class F (Standard Element)

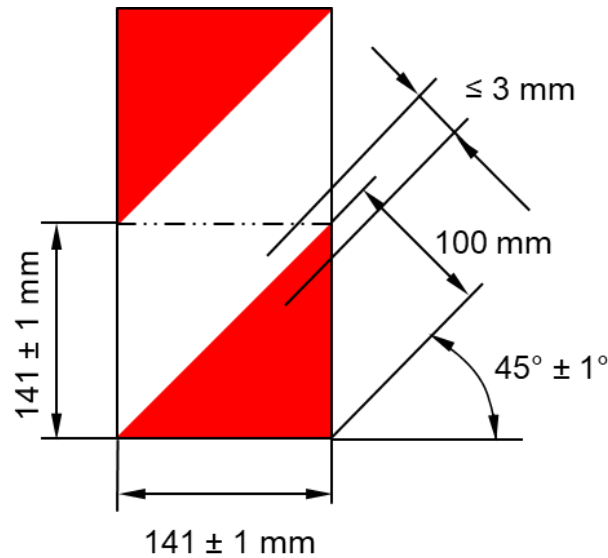

Figure A5-III

Retro-reflective material marking of Class F

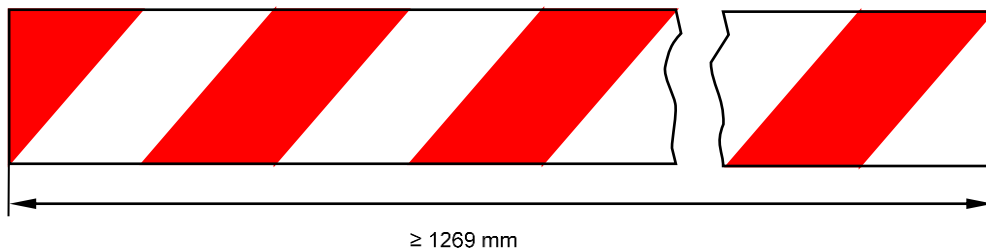
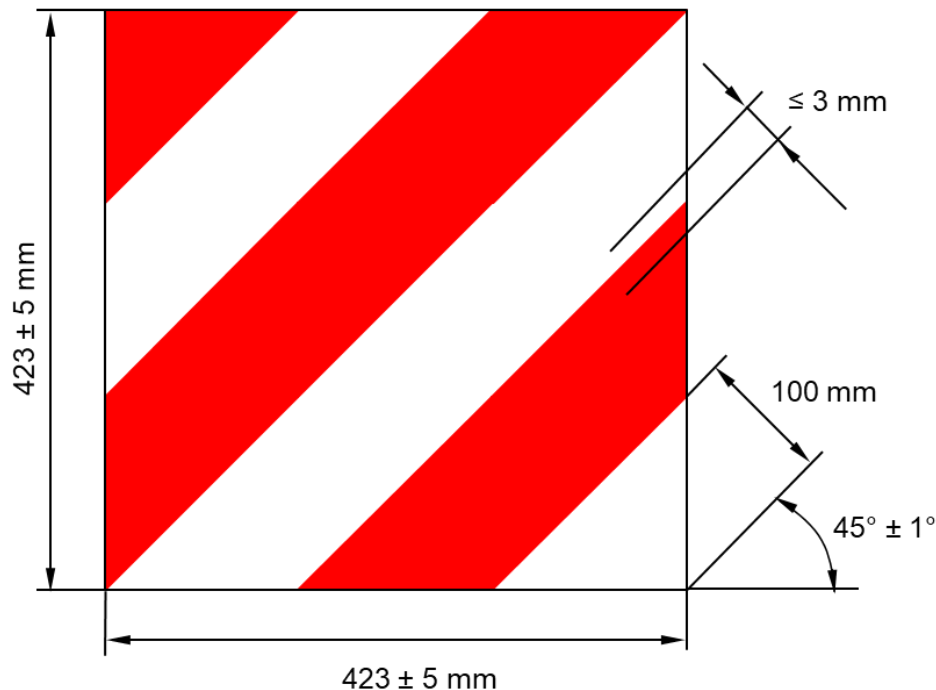

Figure A5-IV
Retro-reflective material marking of Class 5



6. Shape and dimensions of HLV retro-reflective marking plates of Class 1, 2, 3 or 4
 - 6.1. Shape

The plates shall be rectangular in shape for mounting at the rear of vehicles.
 - 6.2. Pattern

For mounting on trailers and semi-trailers, the plates shall have a yellow retro-reflective background with a red fluorescent or retro-reflective border;

For mounting on non-articulated vehicles (tractors or trucks), the plates shall be of the chevron type with alternate, oblique stripes of yellow retro-reflective and red fluorescent or retro-reflective materials or devices.
 - 6.3. Dimensions

The minimum total summarized length of a set of rear marking plates consisting only of one, two or four marking plates with retro-reflective and fluorescent materials shall be 1,130 mm, the maximum total length shall be 2,300 mm.

 - 6.3.1. The width of a rear marking plate shall be:

For trucks and tractors: 140 ± 10 mm.

For trailers and semi-trailers: 200^{+30}_{-5} mm.
 - 6.3.2. The length of each rear marking plate in a set consisting of two plates for trucks and tractors, as illustrated in Figures A5-V and A5-VI, may be reduced, to a minimum of 130 mm, provided that the width is increased such that the area of each marking is at least 735 cm², does not exceed 1,725 cm² and the marking plates are rectangular.
 - 6.3.3. The width of the red fluorescent border of the rear marking plates for trailers and semi-trailers shall be $40 \text{ mm} \pm 1 \text{ mm}$.
 - 6.3.4. The slope of the oblique stripes of the chevron band shall be $45^\circ \pm 5^\circ$. The width of the stripes shall be $100 \text{ mm} \pm 2.5 \text{ mm}$.

Prescribed shapes, patterns and dimensional features are illustrated in Figure A5-V.

6.3.5. Rear marking plates supplied in sets shall form matching pairs.

Figure A5-V
Rear marking Plates (Class 1 and Class 3)

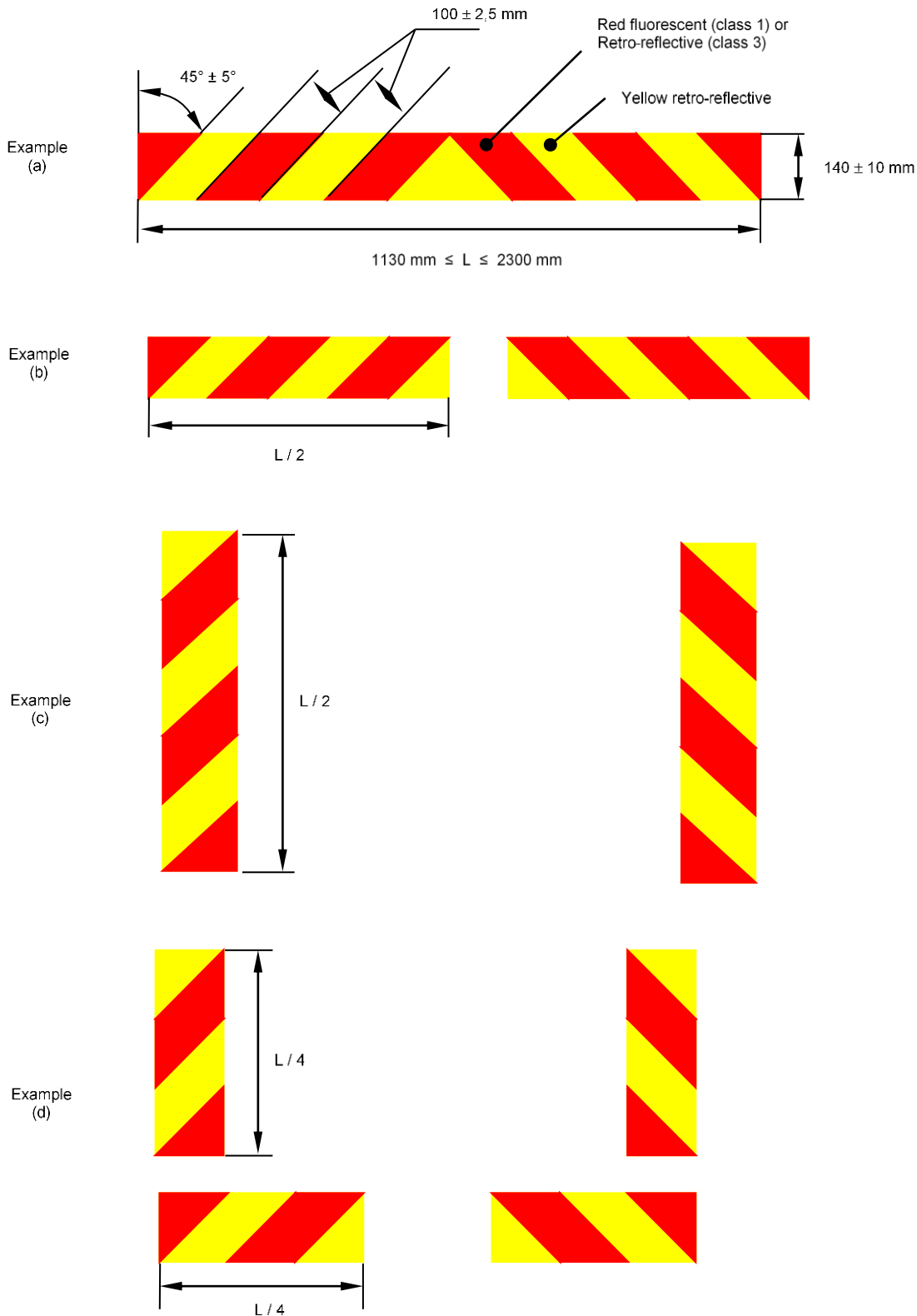
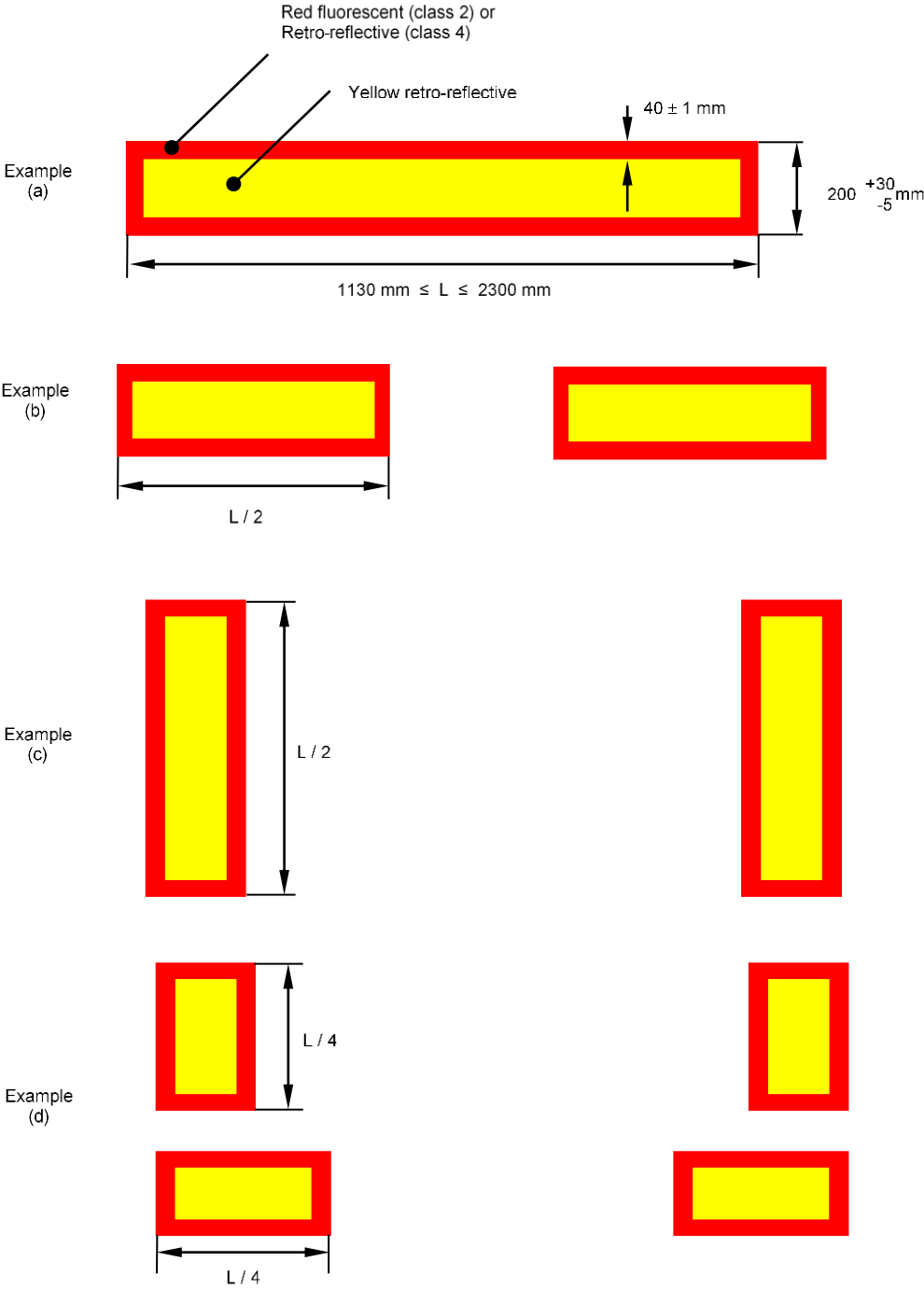

Figure A5-VI
Rear marking Plates (Class 2 and Class 4)



7. Shape and dimensions of SMV retro-reflective marking plates of Class 1 or 2

7.1. Shape

The plates shall be in the shape of an equilateral triangle with truncated corners, for mounting with one apex upwards at the rear of slow-moving vehicles.

7.2. Pattern

The SMV rear marking plates shall have a red fluorescent centre and red retro-reflective borders made of either retro-reflective material or coating or of plastic corner-cube reflectors (class 1). The SMV rear marking plates of class 2 shall have a retro-reflective centre.

7.3. Dimensions

The length of the base of the enclosed fluorescent triangle (class 1) or retro-reflective triangle (class 2) shall be: minimum 350 mm and maximum 365 mm. The minimum width of the light-emitting surface of the red retro-reflective border shall be 45 mm, the maximum width 48 mm. These features are illustrated in the example given in Figure A5-VI.

Figure A5-VII

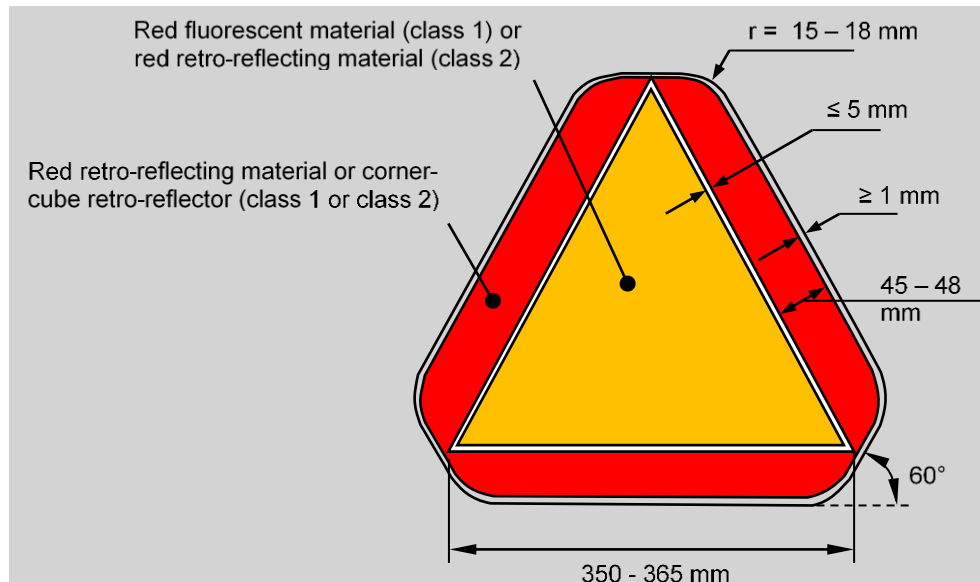
Example of a slow-moving vehicle plate

8. Shape and dimensions of the advance warning triangle Type 1 or 2 (Figure A5-VIII or A5-IX)
 - 8.1. Shape and dimensions of the triangle
 - 8.1.1. The theoretical sides of the triangle shall be 500 ± 50 mm long.
 - 8.1.2. In the case of an advance warning triangle of type 1, the retro-reflecting units shall be arranged along the edge within a strip of an unvarying width which shall be between 25 mm and 50 mm. In the case of an advance warning triangle of type 2 with fluorescent retro-reflecting material, the unvarying width shall be between 50 mm and 85 mm.
 - 8.1.3. Between the outer edge of the triangle and the retro-reflecting strip there may be an edging not more than 5 mm wide and not necessarily red-coloured.
 - 8.1.4. The retro-reflecting strip may be continuous or not. In the latter case the free area of the supporting material shall be red (see also paragraph 5.9.4.2.1. of this Regulation).
 - 8.1.5. In the case of an advance warning triangle of type 1, the fluorescent surface shall be continuous to the retro-reflecting units. It shall be arranged symmetrically along the three sides of the triangle. When in use, its surface area shall be not less than 315 cm^2 . However, an edging, continuous or not, not more than 5 mm wide, which need not necessarily be red-coloured, may be placed between the retro-reflecting surface and the fluorescent surface.
 - 8.1.6. The side of the open centre of the triangle shall have a minimum length of 70 mm (Figure A5-VIII).
 - 8.2. Shape and dimensions of the support
 - 8.2.1. The distance between the supporting surface and the lower side of the advance warning triangle shall not exceed 300 mm
 - 8.3. The fluorescent retro-reflecting material shall be coloured in the mass, either in the retro-reflective elements or as solid surface layer.

Figure A5-VIII
Shape and dimensions of the advance warning triangle of type 1 and of the support

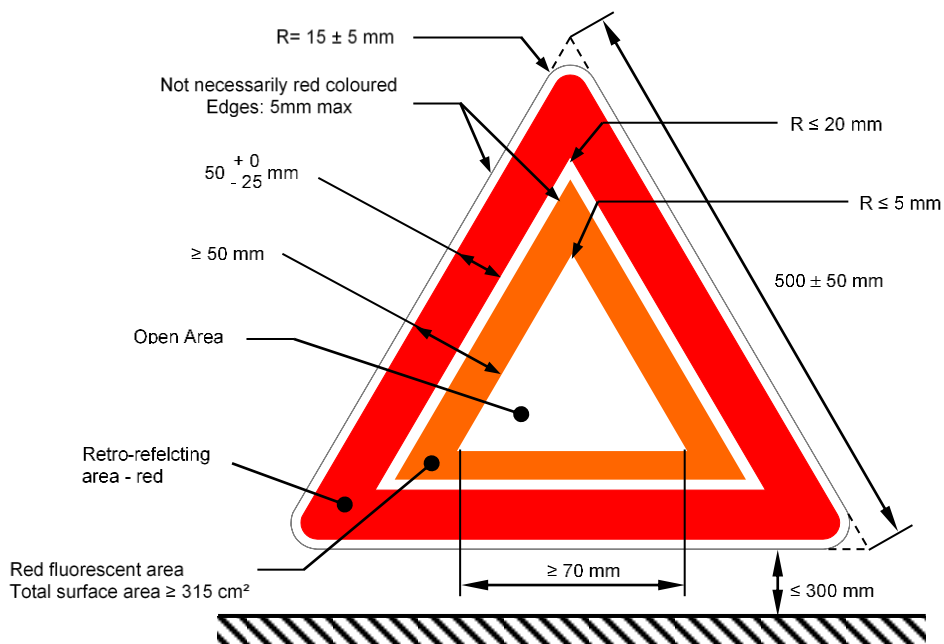

Figure A5-IX
Shape and dimensions of the advance warning triangle of type 2 and of the support

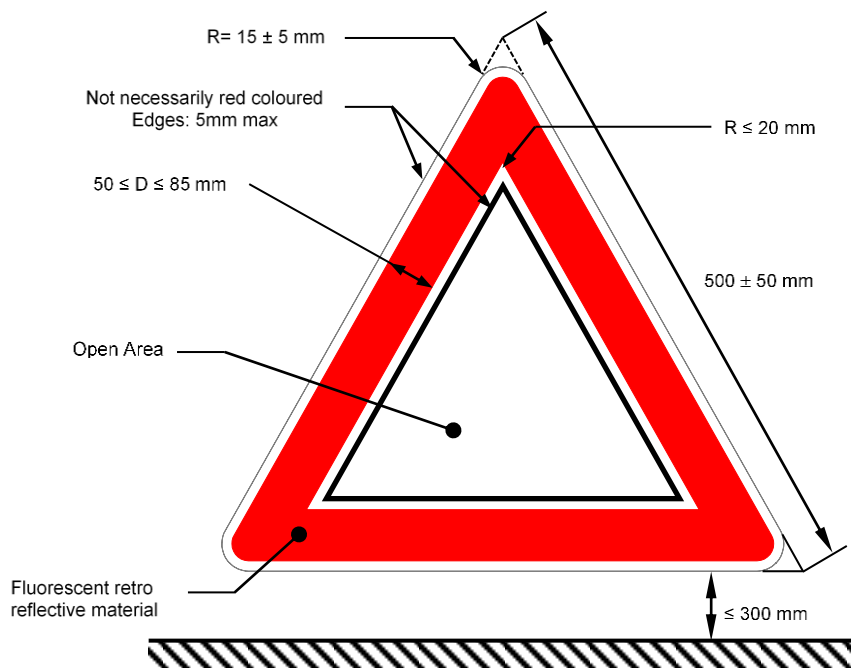
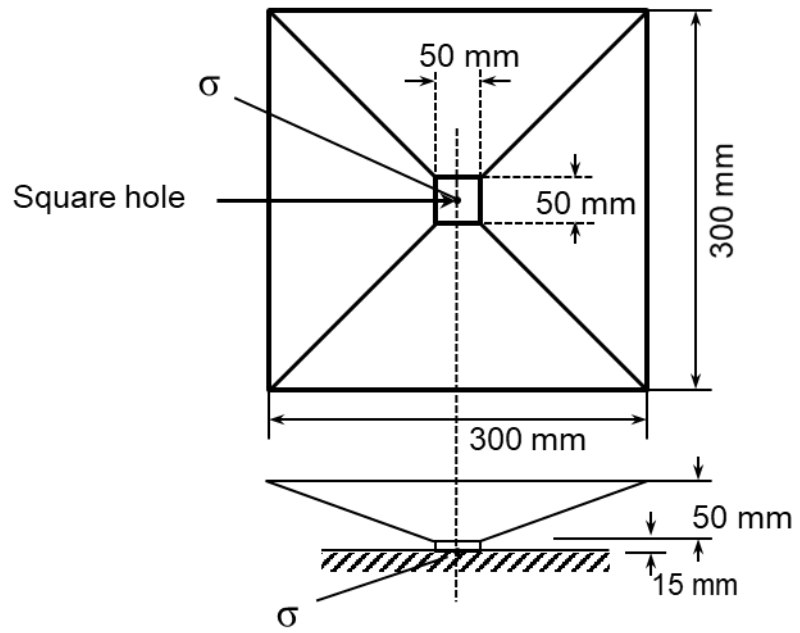

Figure A5-X
Test apparatus for clearance to ground



Annex 6

Environmental Testing

Part 1 - Resistance to heat

1. Test procedure in the case of moulded plastics reflectors of retro-reflecting devices as Classes IA, IB, IIIA, IIIB, IVA, SMV:
The retro-reflective device shall be kept for 48 consecutive hours in a dry atmosphere at a temperature of $65\text{ °C} \pm 2\text{ °C}$ after which the sample shall be allowed to cool for 1 hour at $23\text{ °C} \pm 2\text{ °C}$.
2. Test procedure in the case of use of flexible materials for Classes C, D, E, F, Marking plates of Classes 1, 2, 3, 4, 5:
A section of a sample unit not less than 300 mm long shall be kept for 12 hours in a dry atmosphere at a temperature of $65\text{ °C} \pm 2\text{ °C}$, after which the sample shall be allowed to cool for 1 hour at $23\text{ °C} \pm 2\text{ °C}$. It shall then be kept for 12 hours at a temperature of $-20\text{ °C} \pm 2\text{ °C}$.
The sample shall be examined after a recovery time of 4 hours under normal laboratory conditions.
3. After this test, no cracking or appreciable distortion of the retro-reflective device and, in particular, of its optical component must be visible.

Part 2 - Resistance to water penetration for retro-reflective devices

1. Test for retro-reflectors and retro-reflective marking materials
 - 1.1. Retro-reflective devices whether part of a lamp or not, or a sample unit of retro-reflective marking, shall be stripped of all removable parts and immersed for 10 minutes in water at a temperature of $50\text{ °C} \pm 5\text{ °C}$, the highest point of the upper part of the illuminating surface being 20 mm below the surface of the water. This test shall be repeated after turning the retro-reflective device through 180° , so that the illuminating surface is at the bottom and the rear face is covered by about 20 mm of water. These sample units shall then be immediately immersed in the same conditions in water at a temperature of $25\text{ °C} \pm 5\text{ °C}$.
 - 1.2. No water shall penetrate to the reflecting surface of the retro-reflecting optical unit. If visual inspection clearly reveals the presence of water, the device shall not be considered to have passed the test.
 - 1.3. If visual inspection does not reveal the presence of water or in case of doubt:
 - 1.3.1. In the case of retro-reflectors, the R_1 shall be measured by the method described in paragraph 5.1.3.2.2. of this Regulation, the retro-reflective device being first lightly shaken to remove excess water from the outside.
 - 1.3.2. In the case of a sample unit of retro-reflective marking the coefficient of retro-reflection R' shall be measured in conformity with Part 2 of Annex 6, the sample unit being first lightly shaken to remove excess water from the outside.
2. Test for advance warning triangles
 - 2.1. Test of resistance of the retro-reflective device or fluorescent retro-reflecting material
 - 2.1.1. The triangle - collapsible triangles are to be assembled as for use - shall be immersed for 10 minutes in water having a temperature of $50\text{ °C} \pm 5\text{ °C}$, with the highest point of the upper part of the illuminating surface being about

20 mm below the water surface. Immediately afterwards, this retro-reflective device shall be immersed under the same conditions in water having a temperature of $25\text{ °C} \pm 5\text{ °C}$.

2.1.2. After this test, no water shall have penetrated to the reflecting surface of the retro-reflective device. If a visual inspection clearly reveals the presence of water, the device has not passed the test. Water or water vapour penetration into the edges of fluorescent retro-reflecting materials shall not be deemed to indicate failure.

2.1.3. If the visual inspection does not reveal the presence of water, or in case of doubt the value of the R_l shall again be measured under the same conditions as specified in paragraph 1.2. of Part 2 of Annex 6, after the retro-reflective device has been gently shaken to remove excess water from the outside. The R_l shall not have diminished by more than 40 per cent of the values recorded before the test.

2.2. Water test

The triangle - collapsible advance warning triangles are to be assembled as for use - shall be immersed flat for two hours on the bottom of a tank containing water at $25\text{ °C} \pm 5\text{ °C}$, with the active face of the triangle showing upwards and being 5 cm under the surface of the water. The triangle shall then be removed and dried. No part of the device may exhibit clear signs of deterioration which might impair the effectiveness of the triangle.

3. Test for retro-reflective marking plates

3.1. Resistance to water

A section of a sample unit not less than 300 mm long shall be immersed in distilled water at a temperature of $23 \pm 5\text{ °C}$ for a period of 18 hours; it shall then be left to dry for 24 hours under normal laboratory conditions.

After completion of the test, the section shall be examined. No part inside 10 mm from the cut edge shall show evidence of deterioration which would reduce the effectiveness of the plate.

Part 3 - Alternative test procedures of resistance to water penetration for retro-reflective devices of the Classes IB and IIIB

1. As an alternative, at the request of the manufacturer, the following tests (moisture and dust test) shall be applied.

2. Moisture test

The test evaluates the ability of the sample device to resist moisture penetration from a water spray and determines the drainage capability of those devices with drain holes or other exposed openings in the device.

2.1. Water spray test equipment

A water spray cabinet with the following characteristics shall be used:

2.1.1. Cabinet

The cabinet shall be equipped with a nozzle(s) which provides a solid cone water spray of sufficient angle to completely cover the sample device. The centreline of the nozzle(s) shall be directed downward at an angle of $45^\circ \pm 5^\circ$ to the vertical axis of a rotating test platform.

2.1.2. Rotating test platform

The rotating test platform shall have a minimum diameter of 140 mm and rotate about a vertical axis in the centre of the cabinet.

2.1.3. Precipitation rate

The precipitation rate of the water spray at the device shall be 2.5 (+1.6/-0) mm/min as measured with a vertical cylindrical collector centred on the vertical axis of the rotating test platform. The height of the collector shall be 100 mm and the inside diameter shall be a minimum of 140 mm.

2.2. Water spray test procedure

A sample device mounted on a test fixture, with initial R_I measured and recorded shall be subjected to a water spray as follows:

2.2.1. Device openings

All drain holes and other openings shall remain open. Drain wicks, when used, shall be tested in the device.

2.2.2. Rotational speed

The device shall be rotated about its vertical axis at a rate of $4.0 \pm 0.5 \text{ min}^{-1}$.

2.2.3. If the retro-reflector is reciprocally incorporated or grouped with signalling or lighting functions, these functions shall be operated at design voltage according to a cycle of 5 min ON (in flashing mode, where appropriate), 55 min OFF.

2.2.4. Test duration

The water spray test shall last 12 hours (12 cycles of 5/55 min).

2.2.5. Drain period

The rotation and the water spray shall be turned OFF and the device allowed to drain for 1 hour with the cabinet door closed.

2.2.6. Sample evaluation

Upon completion of the drain period. The interior of the device shall be observed for moisture accumulation. No standing pool of water shall be allowed to be formed, or which can be formed by tapping or tilting the device. The R_I shall be measured according to the method specified in Part 1 of Annex 4 after having dried the exterior of the device with a dry cotton cloth.

2.3. Dust exposure test

This test evaluates the ability of the sample device to resist dust penetration which could significantly affect the photometric output of the retro-reflector.

2.3.1. Dust exposure test equipment

The following equipment shall be used to test for dust exposure:

2.3.2. Dust exposure test chamber

The interior of the test chamber shall be cubical in shape in size 0.9 to 1.5 m per side. The bottom may be "hopper shaped" to aid in collecting the dust. The internal chamber volume, not including a "hopper shaped" bottom shall be 2 m^3 maximum and shall be charged with 3 to 5 kg of the test dust. The chamber shall have the capability of agitating the test dust by means of compressed air or blower fans in such a way that the dust is diffused throughout the chamber.

2.3.3. The dust

The test dust used shall be fine powdered cement in accordance with standard ASTM C 150-84.*

2.3.4. Dust exposure test procedure

* American Society for Testing and Materials

A sample device, mounted on a test fixture, with the initial R_1 measured and recorded, shall be exposed to dust as follows:

- 2.3.5. Device openings
- All drain holes and other openings shall remain open. Drain wicks, when used, shall be tested in the device.
- 2.3.6. Dust exposure
- The mounted device shall be placed in the dust chamber no closer than 150 mm from a wall. Devices with a length exceeding 600 mm shall be horizontally centred in the test chamber. The test dust shall be agitated as completely as possible by compressed air or blower(s) at intervals of 15 min for a period of 2 to 15 s for the duration of 5 hours. The dust shall be allowed to settle between the agitation periods.
- 2.3.7. Measured sample evaluation
- Upon completion of the dust exposure test, the exterior of the device shall be cleaned and dried with a dry cotton cloth and the R_1 measured according to the method specified in paragraph 5.1.3.2.2. of this Regulation.

Part 4 - Resistance to corrosion

1. Retro-reflective devices must be so designed that they retain the prescribed photometric and colorimetric characteristics despite the humidity and corrosive influences to which they are normally exposed. The resistance of the front surface to tarnishing and of the protection of the rear face to deterioration shall be checked, particularly when an essential metal component seems liable to be attacked. The description of the testing of resistance to corrosion is given in ISO Standard 9227:2017.
2. The retro-reflective device, or the lamp if the device is combined with a light, shall be stripped of all removable parts and subjected to the action of a saline mist for a period of 50 hours, comprising two periods of exposure of 24 hours each, separated by an interval of two hours during which the sample is allowed to dry.
3. In the case of retro-reflective devices with essential metal components susceptible to corrosion, the saline mist shall be produced by atomizing, at a temperature of $35\text{ °C} \pm 2\text{ °C}$, a saline solution obtained by dissolving 5 parts by weight of sodium chloride in 95 parts of distilled water containing not more than 0.02 per cent of impurities.
4. Requirements after the corrosion test
 - 4.1. Immediately after completion of the test, the sample shall not show signs of excessive corrosion liable to impair the efficiency of the device.
 - 4.2. The coefficient of retro-reflection R_A of the retro-reflective areas, when measured after a recovery period of 48 hours as specified in Part 2 of Annex 6, at an entrance angle of $\beta_2 = 5^\circ$ and an observation angle of $\alpha = 20'$, shall be not less than the value in Table 9 or more than the value in Table 10 respectively. Before measuring, the surface shall be cleaned to remove salt deposits from the saline mist.

Part 5 - Resistance of the accessible rear face of mirror-backed retro-reflective devices

1. Resistance of the accessible rear face of mirror-backed retro-reflective devices, in the case of moulded plastics reflectors as Classes IA, IB, IIIA, IIIB, IVA and Advance warning triangle of type 1.

2. The reverse side of the retro-reflective device shall be brushed with a hard nylon brush.
3. After having brushed in the case of moulded plastics reflectors as Classes IA, IB, IIIA, IIIB and IVA the rear face of the retro-reflective device, a cotton cloth soaked in the mixture, defined in Part 1 of Annex 7 shall be applied to the said rear face for one minute. The cotton cloth is then removed and the retro-reflective device left to dry.
4. After having brushed, in the case of moulded plastics reflectors of Advance warning triangle of type 1, the reverse side of the retro-reflective device shall then be covered or thoroughly wetted for one minute with a mixture defined in Part 1 of Annex 7. The fuel shall then be removed and the device allowed to dry.
5. As soon as evaporation is completed, the reverse side shall be brushed with the same brush as before.
6. The R_I shall then be measured, according to paragraph 5.1.3.2.2. of this Regulation, after the whole surface of the mirror-backed rear face has been covered with Indian ink.
7. In the case of the retro-reflector of an Advance warning triangle of type 1, the R_I shall not have diminished by more than 40 per cent of the values recorded before the test. This test is not applicable for fluorescent retro-reflecting material.

Part 6 - Resistance to weathering

1. Accelerated artificial weathering
 - 1.1. The apparatus shall be in accordance with EN ISO 4892-1:2016 and EN ISO 4892-2:2013 and shall be capable to control temperature and relative humidity and shall be equipped with a water spray system.
 - 1.1.1. The water spray system shall be capable to spray a minimum of 0.3 ml/cm² within 5 minutes.
 - 1.1.2. The spray water used shall be in accordance to the requirements of EN ISO 4892-2:2013.
 - 1.2. For temperature measurement either a Black-Standard or a Black-Panel thermometer can be used (test method TM1 and TM2).
2. The test method used shall be specified in the report.
3. The samples shall be exposed in accordance with EN ISO 4892-2:2013 using the parameters given in Table A6-1, for a period of 500 hours.

Table A6-1
Accelerated artificial weathering test parameters

<i>TM1 – Black-standard thermometer</i>					
<i>Cycle No. according to EN ISO 4892-2:2013</i>	<i>Exposure period</i>	<i>Irradiance</i>		<i>Black-standard temperature °C</i>	<i>Relative humidity %</i>
		<i>Broadband (300 to 400 nm) W/m²</i>	<i>Narrowband (340 nm) W/m²</i>		
1	102 min dry	60 ± 2	0.51 ± 0.02	65 ± 3	50 ± 10
	18 min water spray	60 ± 2	0.51 ± 0.02		
<i>TM2 – Black-panel thermometer</i>					
<i>Cycle No. according to EN ISO 4892-2:2013</i>	<i>Exposure period</i>	<i>Irradiance</i>		<i>Black-panel temperature °C</i>	<i>Relative humidity %</i>
		<i>Broadband (300 to 400 nm) W/m²</i>	<i>Narrowband (340 nm) W/m²</i>		
4	102 min dry	60 ± 2	0.51 ± 0.02	63 ± 3	50 ± 10
	18 min water spray	60 ± 2	0.51 ± 0.02		

Note 1: Both thermometers will display a different temperature. The results of both test methods are not intended to be necessarily the same. It is recommended to use the temperature sensor that correlates best with the samples, e.g. a Black-Panel thermometer for reflective material that are applied on aluminium substrate. Preparation of test specimens shall be in accordance with the general guidelines given in EN ISO 4892-2:2013. It is good lab practise to relocate the samples in the Xenon tester (rotating drum tester: Bottom, middle top tear; Flat array tester: per quadrant) regularly, e.g. 4-8 times per test. In case of dispute the natural outdoor exposure results will prevail.

Note 2: The ± tolerances given for irradiance, black-panel temperature and relative humidity are the allowable fluctuations of the parameter concerned about the given value under equilibrium conditions. This does not mean that the value may vary by plus/minus the amount indicated from the given value.

Annex 7

Chemical testing

Part 1 - Resistance to fuels

1. A test mixture of 70 vol. per cent of n-heptane and 30 vol. per cent of toluol shall be applied for either:
 - 1.1. A retro-reflective device;
 - (a) The outer surface of the retro-reflective device and, in particular, of the illuminating surface, shall be lightly wiped with a cotton cloth soaked in the test mixture.
 - (b) After about five minutes, the surface shall be inspected visually. It must not show any apparent surface changes, except that slight surface cracks will not be objected to.
 - or;
 - 1.2. A sample unit of retro-reflective marking material;
 - (a) A section of a sample unit not less than 300 mm long shall be immersed in the test mixture for one minute.
 - (b) After removal, the surface shall be wiped dry with a soft cloth and shall not show any visible change which would reduce its effective performance.
2. Test for advance warning triangles:
 - 2.1. The triangle and its protective cover shall be immersed separately in a tank containing a mixture of 70 per cent n-heptane and 30 per cent toluene.
 - (a) After 60 seconds they shall be removed from the tank and drained of excess liquid.
 - (b) The triangle shall then be placed in its cover and the unit shall be laid flat in a still atmosphere.
 - (c) When completely dried, the triangle shall not adhere to its protective cover, and there shall be no visually noticeable change on its surface and shall not present apparent detrimental modifications; however, slight surface cracks may be tolerated.

Part 2 - Resistance to lubricating oils

1. Test procedure in the case of moulded plastics reflectors as Classes IA, IB, IIIA, IIIB, IVA and advance warning triangle of type 1.
 - 1.1. The outer surface of the retro-reflective device and, in particular, the illuminating surface, shall be lightly wiped with a cotton cloth soaked in a detergent lubricating oil. After about 5 minutes, the surface shall be cleaned. The R_I shall then be measured according to paragraph 5.1.3.2.2. of this Regulation.

Annex 8

Mechanical Testing

Part 1 - Resistance to cleaning in the case of a sample unit of retro-reflective marking materials

1. Manual cleaning

A test sample smeared with a mixture of detergent lubricating oil and graphite shall be easily cleaned without damage to the retro-reflective surface when wiped with a mild aliphatic solvent such as n-heptane, followed by washing with a neutral detergent.
2. Power washing

When subjected to a continuous spraying action for 60 seconds on the test component in its normal mounting conditions, a test sample shall show no damage to the retro-reflective surface or delamination from the substrate or separation from the sample mounting surface under the following set-up parameters:

 - (a) Water/wash solution pressure 8 ± 0.2 MPa;
 - (b) Water/wash solution temperature $60 \begin{smallmatrix} + 0 \\ - 5 \end{smallmatrix}$ C°;
 - (c) Water/wash solution flow rate 7 ± 1 l/min;
 - (d) The tip of the cleaning wand to be positioned at distance of 600 ± 20 mm away from the retro-reflective surface;
 - (e) Cleaning wand to be held at no greater angle than 45 degrees from perpendicular to the retro-reflective surface;
 - (f) 40-degree nozzle creating wide fan pattern.

Part 2 - Bonding strength in the case of adhesive materials

1. In case of retro-reflective marking material

For the testing of the bonding strength an aluminium plate as substrate will be used. The application shall be done according to the manufacturer's recommendation.
- 1.1. The adhesion of retro-reflective material shall be determined after 24 hours curing time by utilising a 90-degree peel on a tensile strength testing machine.
- 1.2. The retro-reflective material shall not be easily removable without damaging the material.
- 1.3. The retro-reflective material shall need a force of at least 10 N per 25 mm width at a constant speed of 300 mm per minute to be removed from their substrate.

Part 3 - Flexing - Retro-reflecting Marking Materials

1. For samples that are to be adhered to a flexible substrate, i.e. tarpaulin, the following shall apply:
 - 1.1. A specimen of the sample unit that measures 50 mm by 300 mm shall be bent once lengthwise, around a 3.2 mm mandrel with adhesive contacting the mandrel for a period of 1 second.

- 1.2. The test temperature shall be $23\text{ °C} \pm 2\text{ °C}$.
Note: For ease of testing, spread talcum powder on the adhesive to prevent sticking to the mandrel.
2. After this test, the specimen shall not have cracking of the surface and shall not show any visible change that would reduce its effective performance.

Part 4 - Resistance to impact

1. Rear marking plates (except for plastics corner-cube reflectors)
When a 25 mm diameter solid steel ball is dropped from a height of 2 m onto the retro-reflective and fluorescent surfaces of a supported plate, at an ambient temperature of $23 \pm 2\text{ °C}$, the material shall show no cracking or separation from the substrate at a distance of more than 5 mm from the impacted area.
2. Retro-reflective devices of the Class IVA
The retro-reflective device shall be mounted in a manner similar to the way in which it is mounted on the vehicle, but with the lens faced horizontal and directed upwards.
Drop a 13 mm diameter polished solid steel ball, once, vertically onto the central part of the lens from a height of 0.76 m. The ball may be guided but not restricted in free fall.
When a retro-reflective device is tested at room temperature with this method, the lens shall not crack.

Part 5 - Rigidity of retro-reflective marking plates

1. Classes HLV 1, 2, 3, 4 and 5
 - 1.1. The rear marking plate shall be placed on two supports in such a way that the supports are parallel to the shorter edge of the plate and the distance from either support to the adjacent edge of the plate shall not exceed $L/10$, where L is the greater overall dimension of the plate. The plate shall then be loaded with bags of shot or of dry sand to a uniformly distributed pressure of 1.5 kN/m^2 . The deflection of the plate shall be measured at a point midway between the supports.
 - 1.2. When tested as described in paragraph 1.1. of Part 5 of Annex 8, the maximum deflection of the plate under the test load shall not exceed one twentieth of the distance between the supports in paragraph 1. and the residual deflection after removal of the load shall not exceed one fifth of the measured deflection under load.
2. Classes SMV 1 and 2
 - 2.1. The triangular plate shall be strongly held on one of its long sides, with the clamps of the holding device not encroaching over more than 20 mm. A force of 10N perpendicular to the plane shall be applied to the opposite apex.
 - 2.2. The apex shall then not move in the direction of the force by more than 40 mm.
 - 2.3. After removal of the force, the plate shall visibly return to its initial position. The residual deflection shall not be more than 5 mm.

Annex 9

Further test procedures for Advance Warning Triangles of Type 1 and 2

1. Test of clearance to ground
 - 1.1. The advance warning triangle shall be required to pass the following test:
 - 1.1.1. The test apparatus shown in Figure A5-X, which has the form of an inverted hollow pyramid, shall be placed on a horizontal base plane.
 - 1.1.2. The individual supports to the ground shall be placed one after another in the square hole σ of the test apparatus. During the test of each support, it shall be required to find a position of the test apparatus in relation to the advance warning triangle and its supporting device, which is favourable for the triangle and which ensures that:
 - 1.1.2.1. All supports are resting simultaneously on the base plane,
 - 1.1.2.2. Outside the area covered by the test apparatus, the distance between the base plane and parts of the triangle as well as of the supporting device is at least 50 mm (with the exception of the supports proper).
2. Mechanical solidity test
 - 2.1. When the advance warning triangle has been set up as required by the manufacturer and its bases are firmly held, a force of 2 N shall be applied to the apex of the triangle parallel to the supporting surface and normal to the lower side of the triangle.
 - 2.2. The apex of the triangle shall not move more than 5 cm in the direction in which the force is exerted.
 - 2.3. After the test, the position of the device shall not be significantly different from its original position.
3. Test of heat and low-temperature resistance
 - 3.1. The advance warning triangle, in its protective cover, if provided, shall be kept for 12 consecutive hours in a dry atmosphere at a temperature of $60\text{ }^{\circ}\text{C} \pm 2\text{ }^{\circ}\text{C}$.
 - 3.2. After the test, no cracking or noticeable distortion of the device shall be visible; this applies in particular to the retro-reflective device. The cover shall be readily openable and shall not adhere to the triangle.
 - 3.3. After the heat-resistance test and subsequent storage for 12 consecutive hours at a temperature of $25\text{ }^{\circ}\text{C} \pm 5\text{ }^{\circ}\text{C}$, the advance warning triangle, in its protective cover, is to be kept for another 12 hours in a dry atmosphere at a temperature of $-40\text{ }^{\circ}\text{C} \pm 2\text{ }^{\circ}\text{C}$.
 - 3.4. Immediately after removal from the cold room, no fractures or any visible distortion shall be noticeable on the device and especially on its optical parts. The protective cover, if provided, shall be properly openable, and it shall neither tear nor adhere to the advance warning triangle.
4. Determination of the roughness of the road surface "sandy beach" method
 - 4.1. Purpose of the method
 - 4.1.1. The purpose of this method is to describe and to determine to a certain extent the geometric roughness of that part of the road surface on which the advance warning triangle is placed during the test of stability in wind, as required according to paragraph 5.

- 4.2. Principle of the method
- 4.2.1. A known volume V of sand is spread evenly on the surface of the carriageway in the form of a circle. The ratio of the volume used to the area S covered is defined as "mean sand depth" HS and is expressed in mm:

$$HS = \frac{V}{S}$$

- 4.2.2. The test is carried out by means of round-grain, dry sand and having a grain size between 0.160 mm and 0.315 mm. The volume amounts to $25 \text{ ml} \pm 0.15 \text{ ml}$. The sand is spread out over the surface where the test is carried out by means of a flat, circular disc with a diameter of 65 mm, one side of which is covered with a sheet of rubber having a thickness of 1.5 mm to 2.5 mm and the other being provided with an appropriate handle. If the diameter of the circular area covered with sand is D mm, the mean sand depth will be calculated in accordance with the formula:

$$HS = \frac{4}{\pi} \cdot \frac{25}{D^2} \cdot 10^3 \text{ mm}$$

- 4.3. Performance of the test
- 4.3.1. The surface on which the test is to be carried out shall be dry and at first be brushed with a soft brush to remove any dirt or loose gravel.
- 4.3.2. The sand which has been firmly filled into an appropriate receptacle is then poured out on the surface to be tested in a single heap. The sand is then carefully spread out on the surface by means of repeated circular movements of the rubber faced disc so as to form the largest possible round area covered with sand. The sand will then fill all depressions and hollows.
- 4.3.3. Two diameters, at right angles to one another, of the "beach" thus formed are usually measured. The mean value is rounded off to the nearest 5 mm, with the depth of the sand HS being calculated according to the formula given in paragraph 4.2.2.
- 4.3.4. Six tests of this kind are carried out on the supporting surface, with the parts to be tested being distributed over the surface to be tested as evenly as possible. The overall mean of the results obtained is given as the mean sand depth HS of the road surface where the advance warning triangle has been placed.
5. Test of stability against wind
- 5.1. The advance warning triangle shall be set up in a wind tunnel, on a base measuring about 1.50 m by 1.20 m with a surface formed of abrasive material of the type P36 corresponding to the FEPA** specification 43-1-2006. This surface shall be characterised by its geometric roughness, $HS = 0.5 \text{ mm} \pm 0.05 \text{ mm}$, which shall be defined and determined by the so-called "sandy beach" method according to paragraph 4.
- To avoid a laminar boundary layer of the incident flow over the surface of the base, this base shall have a splitter plate and shall be set up in such a way, that the flow is completely around the plate.
- 5.2. For the air flow the following conditions shall apply:
- (a) The air stream shall reach a dynamic pressure of 180 Pa; and shall have a flow field which shall be homogeneous and free of turbulence;
 - (b) The dimension of the flow field shall be such, that horizontally to each corner and vertical to the top of the advance warning triangle a clearance of at least 150 mm to the border line of this flow field shall exist;

** FEPA: Federation of European Producers of Abrasives, <https://fepa-abrasives.org>.

- (c) The air stream (flow field) shall be parallel to the supporting surface, in a direction which seems to be most unfavourable for the stability;
 - (d) In the case of a closed wind tunnel, the area of the advance warning triangle shall be not larger than 5 per cent of the area cross-section of the closed wind tunnel.
- 5.3. When set up in this manner, the advance warning triangle shall be subjected for 3 minutes to this open-air stream.
- 5.4. The advance warning triangle shall neither overturn nor shift. Slight shifting of the points of contact with the road surface by not more than 5 cm, however, shall be allowed.
- 5.5. The retro-reflecting triangular part of the device shall not rotate through more than 10° round a horizontal axis or a vertical axis from its initial position. The rotation around the horizontal axis or the vertical axis shall be determined by the aid of a virtual plane at the initial position of the retro-reflecting triangular part of the device, which is orthogonal to the base and orthogonal to the air stream.

Annex 10

Arrangement of approval markings

The following approval marking arrangements are given merely as examples and any other arrangement made in accordance with paragraph 3.3. of this Regulation is acceptable.

Figure A10-I

Marking examples for single devices

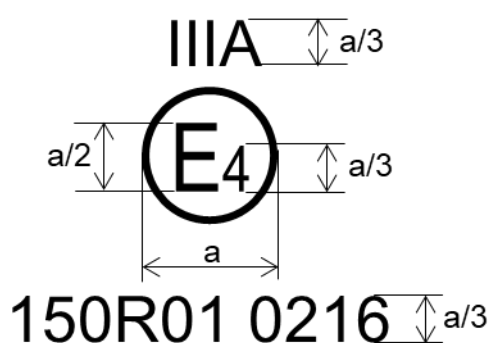

Model A:

This approval mark affixed to a retro-reflective device shows that the type of device concerned has been approved in the Netherlands (E4) under approval number 150R01 0216. The approval number shows that approval was granted in accordance with the requirements of this Regulation as modified by the 01 series of amendments.

For a = see Table 1

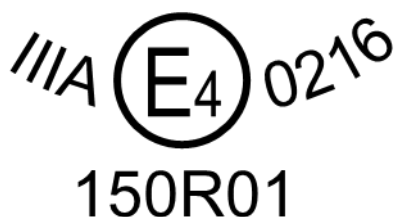

Model B:

Same device as Model A, different arrangement.



Model C:

Same device as Model A, different arrangement.

Note: The above approval number must be placed close to, but in any position in relation to, the circle surrounding the letter "E". The digits constituting the approval number must face the same way as the "E". The group of symbols indicating the class must be diametrically opposite the approval number. The Type Approval Authorities shall avoid using approval numbers IA, IB, IIIA, IIIB and IVA which might be confused with the class symbols IA, IB, IIIA, IIIB and IVA.

These sketches show various possible arrangements and are given as examples only.

Figure A10-II

Simplified marking examples for grouped, combined or reciprocally incorporated devices

Note: The two examples of approval marks, models D and E, represent two possible variants of the marking of a lighting device when two or more lamps are part of the same unit of grouped, combined or reciprocally incorporated lamps.

	3333 Ⓔ ₄ 148R01 150R01	IA	2b	R2	Model D:
		F2	AR	S2	

IA 2b R2 F2 AR S2 3333 Ⓔ ₄ 148R01 150R01				Model E:

Figure A10-III

Arrangement example of the approval mark for retro-reflective marking material

C
Ⓔ₁ 1148
150R01

Figure A10-IV

Arrangement of the approval mark for rear marking plates and SMV

RF
Ⓔ₁
150R01 22179

Figure A10-V
Arrangement of the approval mark for advance warning triangle

WT1
ⓔ₃
150R01
4216

Example A

WT2
ⓔ₃
150R01
4217

Example B

Annex 11

Guidelines for installation of rear marking plates on slow-moving vehicles (by construction) and their trailers

1. It is recommended to the Governments to require on slow-moving vehicles which, by construction, cannot travel faster than 30 km/h, "Rear marking plates for slow-moving vehicles and their trailers" conforming to this Regulation and the specific requirements relating to its scope in accordance with the guidelines given in this annex.
2. **Scope**
The main purpose of these guidelines is to establish requirements for installation, arrangement, position and geometric visibility of rear marking plates on slow-moving vehicles and their trailers which, by construction, cannot travel faster than 30 km/h. It increases the visibility and permits an easy identification of these vehicles.
3. **Number**
At least one.
4. **Arrangement**
The rear marking plate(s) shall be type approved and meet the requirements of this Regulation.
The apex of a rear marking plate shall be directed upwards.
Every part of a rear marking plate shall lie within 5° of a transverse vertical plane at right angles to the longitudinal axis of the vehicle and shall face to the rear.
5. **Position**
In width: If there is only one rear marking plate, it must be on the opposite side of the median longitudinal plane of the vehicle to the direction of traffic prescribed in the country of registration.
In height: Above the ground, not less than 250 mm (lower edge), not more than 1,500 mm (upper edge).
In length: At the rear of the vehicle.
6. **Geometric visibility**
Horizontal angle: 30° inwards and outwards, covering by indispensable constructional parts of the vehicle up to 10 per cent of the rear marking plate surface is permitted;
Vertical angle: 15° above and below the horizontal;
Orientation: rearwards."