

**Economic and Social Council**Distr.: General
4 March 2021

Original: English

Economic Commission for Europe**Inland Transport Committee****World Forum for Harmonization of Vehicle Regulations****Working Party on Passive Safety****Sixty-ninth session**

Geneva, 17-21 May 2021

Item 18 of the provisional agenda

Mutual Resolution No. 1**Proposal for Amendment 3 to Mutual Resolution No. 1****Submitted by the expert from the United Kingdom ***

The text reproduced below was prepared to support the use of the Biomechanical Rear Impact Dummy II (BioRID-II) UN dummy. It was introduced into UN Global Technical Regulation No. 7 by Amendment 1 to the UN GTR (ECE/TRANS/WP.29/2020/85), established into the Global Registry of the 1998 Agreement at the November 2021 meeting of the Executive Committee of the 1998 Agreement. It reflects the work undertaken by the Global Technical Regulation No. 7 (GTR7) Informal Working Group and the GTR7 Technical Evaluation Group to define the dummy and its maintenance procedures. The document is based on informal document GRSP-54-05 presented at the fifty-fourth session of the Working Party on Passive Safety (GRSP) (see ECE/TRANS/WP.29/GRSP/54, para. 4). Annex 3, Certification Procedures, replaces the proposal of informal document GRSP-68-23 presented at the sixty-eighth session of GRSP (see ECE/TRANS/WP.29/GRSP/68, para. 30).

* In accordance with the programme of work of the Inland Transport Committee for 2021 as outlined in proposed programme budget for 2021 (A/75/6 (Sect.20), para 20.51), the World Forum will develop, harmonize and update UN Regulations in order to enhance the performance of vehicles. The present document is submitted in conformity with that mandate.



I. Proposal

Contents, amend to read:

"Contents

Page

Preamble.....

I. Statement of technical rationale and justification

II. Mutual Resolution (M.R.1) of the 1958 and 1998 Agreements concerning the description and performance of test tools and devices necessary for the assessment of compliance of wheeled vehicles, equipment and parts according to the technical prescriptions specified in Regulations and global technical regulations.....

1. Scope

2. General provisions

3. Specific provisions

Appendix.....

Addendum 1 - **Specifications for the Construction, Preparation and Certification of the 50th percentile male Biofidelic Rear Impact (BioRID-II UN) anthropomorphic test device**.....

Addendum 2 - Specifications for the Construction, Preparation and Certification of the World Side Impact 50th percentile adult male anthropomorphic test device (WorldSID 50th male)

Addendum 3 - Specifications for the Construction, Preparation and Certification of the flexible Pedestrian Legform Impactor (FlexPLI).....

"

Section II,

Paragraphs 3. and 3.1., Specific provisions, amend to read:

"3. Specific provisions

3.1. The table below details the individual addenda to this Mutual Resolution in which details of the design, construction, maintenance and preparation of the test devices or equipment can be found.

<i>ECE/TRANS/WP.29/1101</i>	<i>Generic name of the Test Tool</i>	<i>UN Regulation(s) requiring the test Tool Device</i>	<i>UN Global technical regulation(s) requiring the Test Tool or Device</i>	<i>Date of adoption of the Addendum</i>
Amend 3 - Addendum 1 to M.R.1	(Reserved) BioRID Dummy	No. 17	No. 7	...
Amend.1 - Addendum 2 to M.R.1	WorldSID 50 th male Dummy	No. 135	No. 14	12 Nov. 2014
Amend.2 - Addendum 3 to M.R.1	FlexPLI	No. 127	No. 9	13 Nov. 2019
... - Addendum 4 to M.R.1	(Reserved) Q-Dummy			

"

Appendix, amend to read:

"Appendix

Addendum 1 - Specifications for the Construction, Preparation and Certification of the 50th percentile male Biofidelic Rear Impact (BioRID-II UN) anthropomorphic test device

Contents

	<i>Page</i>
1. Introduction.....	X
1.1. General Design.....	X
1.2. Instrumentation	X
1.3. Required Tools	X
1.4. Abbreviation of Screw Types.....	X
2. Physical Properties	X
2.1. Dimensions.....	X
2.2. Dimensional Conformity Check.....	X
2.3. Masses	X

Annexes

1 Assembly, Disassembly and Inspection	X
1. Mechanical Subsystems	X
1.1. Head.....	X
1.2. Spinal Column – Cervical Portion	X
1.3. Spinal Column – Thoracic and Lumbar Portions.....	X
1.4. Spinal Column – Muscle Substitute System	X
1.5. Static Spine Setup Procedure	X
1.6. Torso Flesh and Lifting Bracket	X
1.7. Pelvic Assembly	X
1.8. Arms	X
1.9. Legs	X
1.10. Joint Adjustment Procedure.....	X
1.11. Clothing	X

2.	Instrumentation	X
2.1.	Head assembly	X
2.2.	Spinal Colum – Cervical Portion	X
2.3.	Thoracic and Lumbar Portions	X
2.4.	Pelvis	X
2.5.	Cable Routing	X
2.6.	Accelerometer Handling	X
3.	Bumper Maintenance	X
3.1.	Overview	X
3.2.	Replacement Interval	X
3.3.	Replacement Procedure	X
4.	Storage and Handling	X
4.1.	Transport Chair	X
2.	Engineering Drawings and Parts List	X
1.	Drawings	X
1.1.	Introduction	X
1.2.	Drawing Descriptors	X
1.3.	Revisions	X
2.	Parts	X
3.	Part Numbers	X
4.	List of Appendices	X
	Appendix 1 – Assembly Drawings	X
	Appendix 2 – Head	X
	Appendix 3 – Cervical Spine	X
	Appendix 4 – Thoracic and Lumbar Spine	X
	Appendix 5 – Torso and Pelvis	X
	Appendix 6 – Muscle Substitute	X
	Appendix 7 – Limbs	X
	Appendix 8 – Tools	X
3.	Certification Procedures	X
1.	Introduction	X
2.	Required Test Equipment and Specifications	X
3.	BioRID-II UN Certification Procedures	X
4.	Jacket Certification Procedures	X
5.	Lower Torso Certification Procedures	X
6.	Jacket/Lower torso Compression Calculation	X
7.	Certification Test Report Details	X
	Appendix 1 – BioRID-II UN Sled and Track System Validation	X

1. Introduction

This document, addendum 1 to the Mutual Resolution, sets out a standard specification for build and certification of the Biofidelic Rear Impact Dummy (BioRID-II UN).

BioRID-II UN is a 50th percentile male dummy, developed to mimic occupant behaviour in automotive rear impact collisions of low severity.

BioRID-II UN has a fully articulated spine, providing a more anthropomorphic response in a collision while still maintaining the level of repeatability and reproducibility established by previous dummies used in automotive impact testing.

BioRID-II UN is equipped to record many measurements, including thorax loading and head acceleration and rotation, which can be correlated to the risk of whiplash associated disorders and other injuries.

1.1. General Design

For the purposes of application in the context of UN ECE Regulations and Global Technical Regulations, the BioRID-II UN anthropomorphic test device (dummy) is defined by compliance with the build and certification requirements set out in this document and in the accompanying engineering drawings. The generic build level, e.g. BioRID-IIg, is not sufficient to determine the status of the dummy and it is necessary to establish that the individual components that comprise the dummy are manufactured to the level of drawing revision tabled in Annex II. Drawing references in this document refer to the relevant appendix of Annex II and the drawing number, e.g. App.9/Dwg.004.

BioRID-II UN incorporates a fully articulated two-dimensional spine with 24 vertebrae. The spine consists of seven cervical (C1-C7), twelve thoracic (T1-T12) and five lumbar (L1-L5) vertebrae.

The head assembly and the top cervical vertebra (C1) are connected using an occipital interface plate. This interface plate provides for the mounting of a 6-channel upper neck load cell. The superior thoracic vertebra (T1) is contoured as a cervical vertebra on the upper side and as a thoracic vertebra on the lower side to mate the cervical and thoracic regions. Similarly, the upper surface of the superior lumbar vertebra (L1) is shaped like the thoracic vertebrae and the underside shaped like the lumbar vertebrae to mate the thoracic and lumbar regions. The lowest lumbar vertebra (L5) connects the spine to the pelvis through a sacrum lumbar and pelvis interface plate.

The vertebrae for the BioRID-II UN are made of durable plastic connected with pins at each joint that allow for angular motion in the sagittal plane only. The occipital and pelvis interfaces are made of aluminium. There are elastomeric blocks (bumpers) glued to the top of each vertebra to simulate the compression resistance of the muscles and discs between each human vertebra.

To increase the biofidelity of the neck motion response, tensioning cables are incorporated into the neck region of the spine. The three cables, originating at the top of the neck, have threaded adjustments for controlling cable tension. One cable goes through the cervical vertebrae, around a damper assembly at the T4 vertebra and back through the vertebrae to the top of the neck. The two other cables also start at the top of the neck but terminate at two spring-loaded cable-tensioning devices mounted on the right side of the torso.

The upper torso flesh is made of moulded silicone. Included in the flesh mould are the left and right arm attachment yokes with reinforcement plates, the abdomen interface attachment, the abdomen cavity, the abdomen valve and the spine-torso interface. The flesh material and/or external surface characteristics enable positive attachment of adhesive targets.

The arms are Hybrid III 50th percentile dummy assemblies and the head and pelvis are modified Hybrid III 50th percentile dummy assemblies. The legs are Hybrid III 50th percentile dummy legs with the knee sliders replaced with pedestrian blocks.

1.2. Instrumentation

1.2.1. Available Instrumentation

Table 1 lists the instrumentation for the BioRID-II UN Dummy. Section 2.5 of Annex 1 describes cable installation requirements. It shall be ensured that any changes of instrumentation do not alter the mass or centre of mass of components.

Table 1
BioRID-II UN Instrumentation

<i>Measurement</i>				
Location	Type	Required	Optional	Number of Channels
Head	Accelerometer	AX	AY, AZ	1 – 3
Head	Tilt Sensor		Angle	2
Head	Angular Rate Sensor (ARS)		AVX, AVY, AVZ	1 – 3
Head	Contact Switch	Event		1
Upper Neck	Load Cell	FX, FZ, MY	FY, MX, MZ	6
Lower Neck	Load Cell	FX, FZ, MY		3
Thorax (T1) right	Accelerometer	AX, AZ		2
Thorax (T1) left	Accelerometer	AX, AZ		2
Thorax (T1)	Angular Rate Sensor (ARS)		AVX, AVY, AVZ	1 - 3
Thorax (T8)	Tilt Sensor		Angle	2
Thorax (T8)	Accelerometer		AX, AZ	1
Thorax (T8)	Angular Rate Sensor (ARS)		AVX, AVY, AVZ	3
Lumbar (L1)	Angular Rate Sensor (ARS)		AVX, AVY, AVZ	2
Lumbar (L1)	Accelerometer		AX, AZ	1 - 3
Lumbar (L5)	Load cell		FX, FY, FZ, MX, MY, MZ	6
Pelvis	Accelerometer		AX, AY, AZ	3
Pelvis	Tilt Sensor		Angle	2
Pelvis	Angular Rate Sensor (ARS)		AVX, AVY, AVZ	3

1.2.2. Instrumentation Location

The location of the instrumentation shall be as illustrated in Figure 1.

Figure 1

Instrumentation location

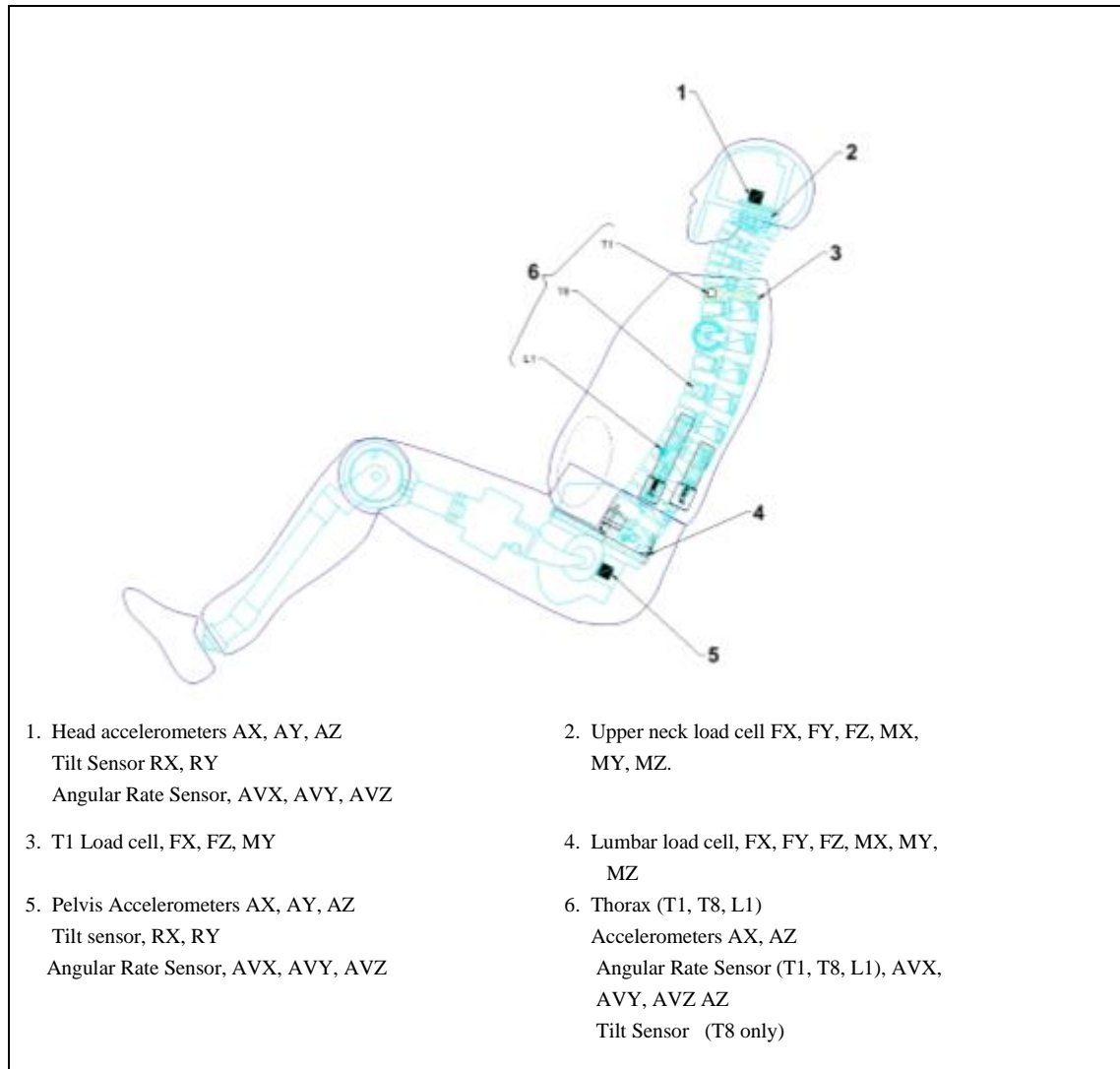

1.3. Required Tools

The following special tools will allow assembly, disassembly and calibration of the BioRID-II UN Dummy.

Hex spanner, Ball end (0.05" – 3/8" and 1.5 mm – 10 mm)

Hex spanner, 'T'-handle (3/32" - 3/8" and 2 mm – 10 mm)

Screwdriver, standard tip (2.5 mm tip width)

Pin punch (6 mm dia.)

Brass mallet

Thread locking adhesive (e.g. cyanoacrylate)

Open-end spanner (13 mm)

Synthetic gear oil of ISO viscosity grade 680

1.4. Abbreviations of Screw Types Used

The abbreviations listed in table 2 shall be used within this addendum

Table 2
Abbreviations of screw types

<i>Screw Type</i>	<i>Abbreviation</i>
Socket Head Cap Screw	SHCS
Button Head Cap Screw	BHCS
Flat Head Cap Screw	FHCS
Socket Set Cup Point	SSCP
Socket Head Shoulder Screw	SHSS

2. Physical Properties

2.1. Dimensions

Table 3 specifies key dimensions that are checked when the dummy is seated in the dummy measurement chair. These measurements enable dimensional conformity to be checked without having to inspect every component and allow the level of compression in the flesh to be monitored. These checks shall be performed whenever the dummy is certified. If the measurements show deviation from the values provided in this section the components of the dummy shall be checked individually against the relevant details and drawings provided in this document.

The dummy measurement chair shall feature a flat, rigid, smooth, clean, dry, horizontal surface. The seating surface shall be at least 406 mm wide and 406 mm deep, with a vertical section at least 406 mm wide and 914 mm high attached to the rear of the seating fixture. It shall feature an adjustable head strap capable of supporting the dummy's head against forward movement. A suitable chair is shown in Figure 2.

Table 3
Dimensions of BioRID-II UN

Feature	Millimetres	
	Lower	Upper
H-Point above seat	84	89
H-Point from Seat Rear	135	140
Seated Height	879	889
Thigh Clearance	140	155
Buttock to Knee Length	579	605
Knee Pivot Height	485	500
Foot Length	251	267
Foot Width	91	107

Figure 2
Seating the dummy in the measurement chair



1. Head Level Tool. 2. Head Strap. 3. H-Point Tool
(App.9/Dwg.004)

2.2. Dimensional Conformity Check

Level the seat of the dummy measurement chair such that it lies parallel to the X-Y plane in the coordinate reference system. Zero a digital inclinometer on the seat surface with it oriented in the X-coordinate direction.

Position the dummy on the measurement chair such that the dummy's midsagittal plane is vertical and centred upon the seat surface. Position the head strap of the chair so it runs around the front of the head, directly under the nose (Figure 2). Insert the head levelling tool on the top of the skull, then insert an H-Point tool through the pelvis into the H-Point reference square hole mounted at the base of the spine. The critical dimensions of an H-Point tool are shown in Figure 3.

Figure 3
Critical Dimensions for an H-Point Tool

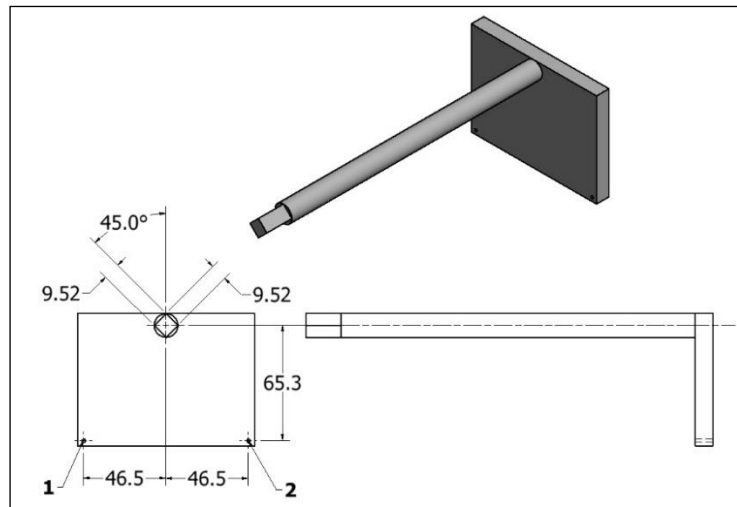

1. H-Point reference location for the right-hand side
2. H-Point reference location for the left-hand side

Position the lower torso so the H-Point reference hole on the H-point tool is between 135 - 140mm from the seat back on both sides of the dummy when measured in the X coordinate direction (Figure 4). Measure the height (Z coordinate direction) from the seat to the H-Point reference hole (Figure 5) and compare to the tolerance band specified in table 3. Place the inclinometer on the top of the H-Point tool (Figure 6) and confirm the angle is 0 +/-2 degrees (the tilt sensor may be used as an alternative). If necessary, adjust the dummy position and repeat the measurements of the H-point positions (X and Z directions) and angles until all are within tolerance.

Figure 4
Setting the longitudinal position of the lower torso
1. Seat Back. 2. H-Point reference hole

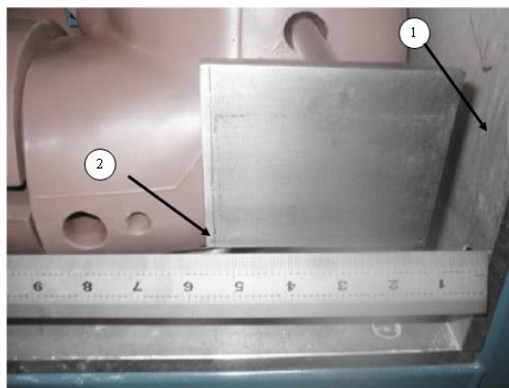

Figure 5
Measuring the H-Point height (left side)



Figure 6
Measuring the H-point tool angle



Place the inclinometer on the top of the head levelling tool (Figure 7) (the tilt sensor may be used as an alternative). The head angle shall be 26.5 ± 2 degrees. The head strap may be adjusted to allow slump on the spine to attain the correct angle.

Measure the thigh clearance by placing a straight edge across the highest point on the thighs and measuring the vertical distance (Z coordinate direction) from the seat to the bottom of the straight edge on each side of the dummy (Figure 8). Hold the measuring rule in a vertical orientation such that it touches the outer thigh.

Figure 7
Measuring the angle of the head levelling tool



Figure 8
Measuring the thigh clearance



To find the buttock to knee length, place a straight edge across the furthest forward point of both the knees and measure the distance (X coordinate direction) between the straight edge to the seat back. Measurements shall be taken on either side such that the tape or rule is oriented in the X direction and touches the side of the dummy (Figure 9).

Place a spirit level on the top of the head and centre the bubble. Measure the dimension from the seat to the underside of the level (Z coordinate direction) to find the seated height (Figure 10).

Level the feet front to back by holding a digital inclinometer to the soles of the feet. Place a straight edge transversely under the balls of the feet, such that it contacts both feet, and measure the vertical distance between the straight edge and the knee pivot to find the knee pivot height on both sides of the dummy, as shown in Figure 11. The measuring device shall be vertical and shall touch the dummy. Measure the length and width of each foot using a rule at the longest and widest points of the foot respectively.

Figure 9
Measuring the knee to buttock length



Figure 10
Measuring the seated height of the dummy



Figure 11
Measuring the left knee pivot height



2.3. Masses

The mass of the BioRID-II UN dummy segments shall conform to the specifications in table 4. After replacing parts, including instrumentation, the mass of the segment containing the replaced part shall be rechecked.

Table 4
Masses of BioRID-II UN components

Assembly	Mass (kg)	
	Lower Corridor	Upper Corridor
Head	4.49	4.58
Torso (Inc. water)	41.96	42.86
Arm (each)	3.56	3.83
Hand (each)	0.52	0.61
Leg (each)	10.12	10.43
Foot (each)	1.09	1.22
Shoe (each)	0.47	0.67
Shorts (inner + outer)	0.17	0.28
Shirt (inner + outer)	0.23	0.38

Annex 1

Assembly, disassembly and inspection

This annex deals with protocols for assembly, disassembly and maintenance of the BioRID-II UN dummy. For parts lists and engineering drawings of the components referred to in this annex, see Annex 2. For design and maintenance checklists, see Annex 3, Appendix 2.

1. Mechanical Subsystems

1.1. Head

1.1.1. Assembly

BioRID-II UN uses a modified Hybrid III 50th percentile head assembly. The skull base and ballast are modified to accommodate the upper neck load cell and the tensioning cables that extend out of the neck section. The skull cap is modified to provide clearance for the neck adjusters and instrumentation cables without transferring load to the bottom of the load cell. Figure 1 shows a breakdown of all head components, which are listed within Annex 2.

1.1.2. Removal

To remove the head from the neck assembly, loosen the two M4 nylon tipped set screws clamping the condyle pin to the occipital condyle plate and firmly press down on the top of the head assembly to compress the elastomer bumpers on the occipital condyle. While the bumpers are compressed, push the condyle pin out of the head-neck joint using a 6mm rod toward the dummy's right side. Once the pin is removed, lift the head away from the neck assembly.

1.1.3. Disassembly

Take out the two 1/4-20 x 5/8" Unified National Coarse (UNC) SHCS securing the skull cap assembly to the skull. Disconnect the two connector plugs at the top surface of the upper neck load cell, inside the head, by sliding the outer sleeve of the connector away from the load cell. Remove the four 1/4-28 x 5/8" Unified National Fine (UNF) SHCS at the base of the skull.

Push the load cell into the inside of the skull and rotate it 90° so that the occipital condyle hole is vertical. The load cell can then be extracted through the back of the skull.

Accelerometers may be mounted on the top surface of the upper neck load cell. To remove them from the load cell, take out the four #10-24 x 5/8" (UNF) SHCS that secure the mounting plate in place.

To remove the head skin from the assembly, lift the rear flaps and peel it away from the skull. Check the skin for damage.

Figure 1
Head assembly exploded view (Refer to Appendix 2, Table 1)

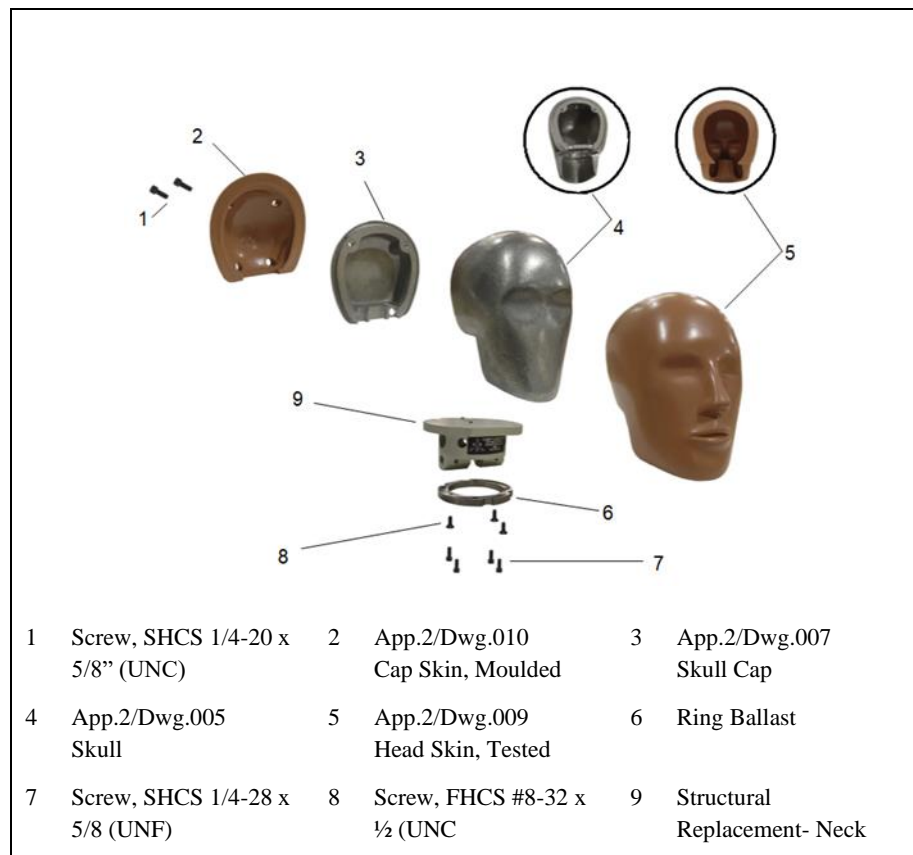

1.2. Spinal Column – Cervical portion

1.2.1. Assembly

The cervical portion of the spine assembly links the T1 vertebra to occipital interface plate. Figure 2 shows a breakdown of the assembly, the components for which are listed within Annex 2.

1.2.2. Disassembly

Prior to disassembly of the spine, loosen or remove the muscle substitute assembly as described in section 1.4.2

To disassemble the cervical spine, take off the M8 jam nuts on each side of the spine at the C7–T1 joint and loosen or remove the two M2.5-0.45 x 8mm SHCS used to lock the T1 pin to the vertebrae, then push the T1 pin out of the assembly. Do not hammer or directly impact the joint; this may cause damage. Use a 6mm punch and tap lightly to slide the remaining cervical spine pins out, until the cervical spine is completely disassembled.

1.2.3. Bumper Maintenance

There are elastomeric bumper pads on each vertebra. Check the bumpers; if any are loose, have become detached or have reached their maximum age; follow the procedure described in section 3.3.

Figure 2
Breakdown of components in the cervical portion of the spinal column
 (Refer to Appendix 3, Table 1)

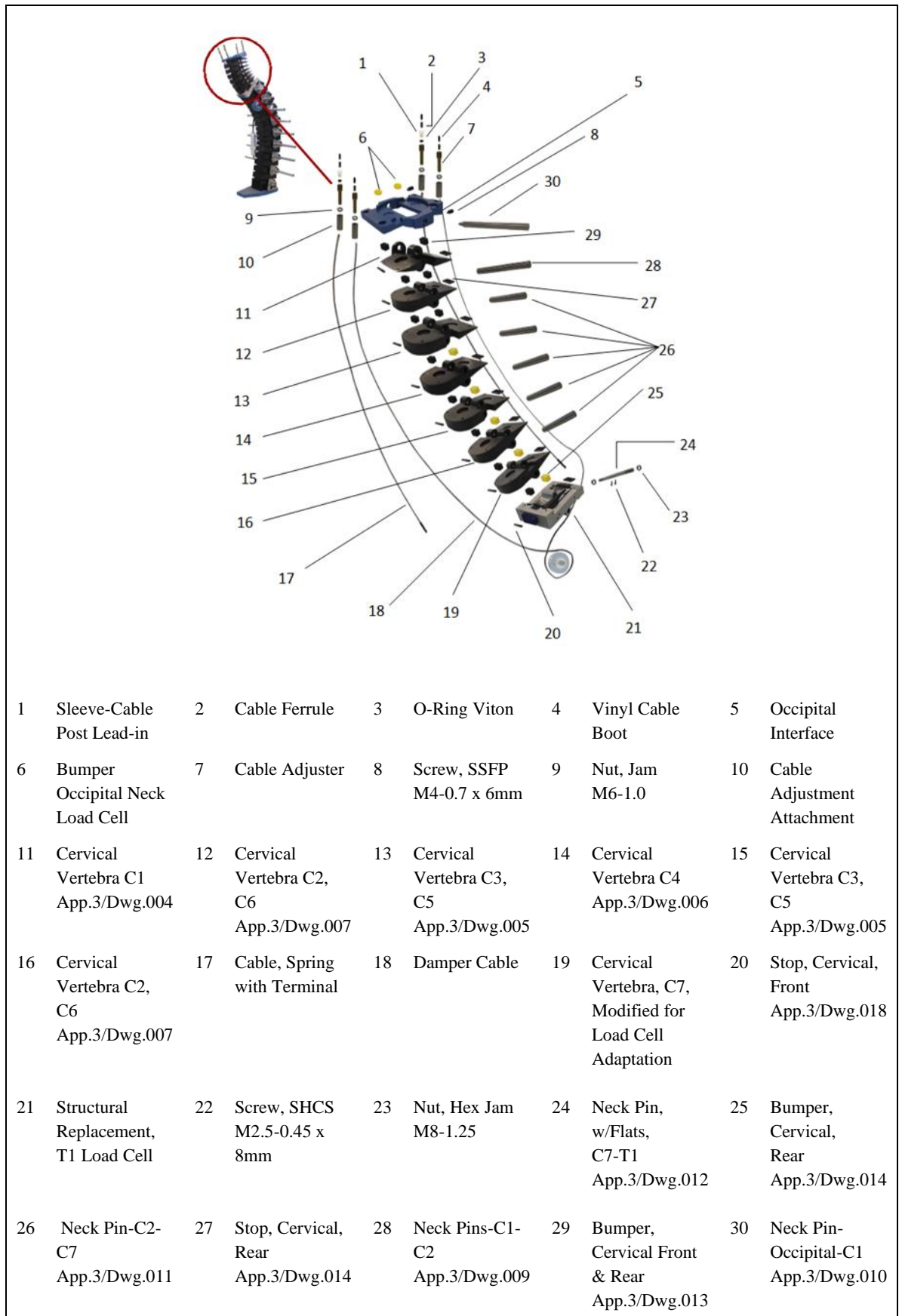

1.3. Spinal Column - Thoracic and Lumbar Portions

1.3.1. Assembly

Figures 3 and 4 illustrate the thoracic and lumbar region of the spine; a list of components may be found in Annex 2.

1.3.2. Disassembly

To facilitate disassembly of the spine, the muscle substitute assembly shall first be loosened or removed as described in section 1.4.2.

Before starting to remove each vertebra, it is recommended that each component is marked with tape or paint to aid reassembly. The torsion adjustment washer position at each vertebral junction can be marked with a paint marker to show its position relative to the torsion washer.

Take out the four M6-1.0 x 25 FHCS at the underside of the interface plate and pull the pelvis interface plate away from the spine. Remove the M8-1.25 x 12 SHCS and washers that lock the adjustment washers in place on the torsion washer.

To remove the pins, lay the spine assembly on a firm, flat work surface with the pins vertical. Use two wooden blocks to provide clearance under the spine for the pins to move downward. Starting with the pin joining S1 and L5, tap the pin out of the torsion washer on the dummy's left side using a 6mm pin punch and a brass mallet or equivalent. Take care not to damage the pin, washer or vertebrae through use of excessive force.

Continue working along the spine assembly separating the torsion pins from the torsion washers. After all the pins on one side are loose, turn the spine over and repeat the process on the opposite side until all the pins are free from the torsion washers.

Pull the pins and torsion washers from the spine assembly. For easier re-assembly, take out the pin-adjustment washer assemblies one at a time starting at the S1-L5 joint, working bottom to top, and set aside each part as it is taken off so that it can be re-assembled in the same sequence. Note that there are shim or spacer washers at S1 between the torsion washer and the vertebra, and at T4 there is a cable pulley wheel inside; these must be reinstalled correctly upon reassembly. If any bumpers are loose or have fallen off, they shall be re-glued to the vertebra using the procedure described in 3.3.

Figure 3
Spinal Column - Thoracic and Lumbar - Part 1
 (Refer to Appendix 4, Table 1)

1	App.4/Dwg.016	2	App.4/Dwg.010	3	App.4/Dwg.025	4	App.4/Dwg.018	5	App.4/Dwg.019
	Thoracic		Thoracic		Thoracic		Thoracic		Thoracic
	Vertebra T3		Vertebra T2		Bumper, Yellow, 30A Durometer		Vertebra T5		Vertebra T6
6	App.4/Dwg.019	7	App.4/Dwg.020	8	App.4/Dwg.019	9	App.4/Dwg.019	10	App.4/Dwg.019
	Thoracic		Thoracic		Thoracic		Thoracic		Thoracic
	Vertebra		Vertebra T8		Vertebra T9		Vertebra		Vertebra T11
11	App.4/Dwg.034	12	App.4/Dwg.035	13	App.4/Dwg.035	14	App.4/Dwg.036	15	Washer, Flat 5/16 x 3/4
	Lumbar		Lumbar		Lumbar		Bumper- Lumbar-Rear		
	Vertebra L1		Vertebra L3		Vertebra L4				
16	App.5/Dwg.028	17	Screw. M8- 1.25 x 25 SHCS	18	App.4/Dwg.043	19	Screw M6-1.0 x 25. FHCS	20	App.5/Dwg.026
	H-Point Position Attachment, Left				Pelvis to Spine Attachment				Interface Plate/Abdomen Anti-Slap Gasket
21	Screw. M6-1.0 x 12 FHCS	22	App.5/Dwg.023	23	Screw. M6-1.0 x 12 SHCS	24	App.5/Dwg.029	25	App.4/Dwg.042
			Pelvis Interface Abdominal Attachment				H-Point Position Attachment, Right		Sacrum to L5 Adapter Plate S1
26	App.4/Dwg.035	27	App.4/Dwg.037	28	App.4/Dwg.035	29	App.4/Dwg.019	30	App.4/Dwg.026
	Lumbar		Bumper- Lumbar-Front		Thoracic		Thoracic		Thoracic
	Vertebra L5				Vertebra T12		Vertebra T12		Bumper, Black, 37A
31	App.6/Dwg.009	32	App.6/Dwg.002	33	App.4/Dwg.017				
	Rotary Damper Assembly		Cable Guide Wheel		Thoracic Vertebra T4				

Figure 4
Spinal Column - Thoracic and Lumbar - Part 2.
 (Refer to Appendix 4, Table 1 and Appendix 5, Table 1)

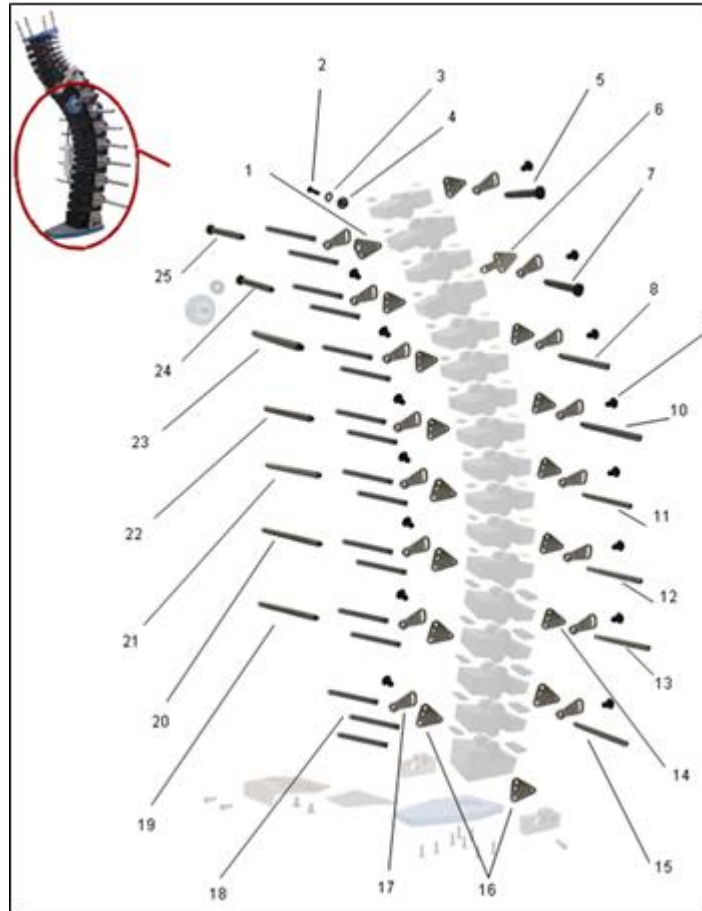

1	App.4/Dwg.021Washer, Torsion T1	2	Screw, BHCS M6-1.0 x 22	3	Washer, 5/8 OD x 5/32 ID x .06 Thick
4	Spacer	5	App.5/Dwg.012Assembly-Spine-Torso Interface Pin L1	6	App.4/Dwg.022 Torsion Washer T4
7	App.5/Dwg.012Assembly-Spine-Torso Interface Pin L2	8	App.5/Dwg.010Assembly-Spine-Torso Interface Pin L3	9	Screw. BHCS M8-1.25 x 12 16 places
10	App.5/Dwg.011Assembly-Spine-Torso Interface Pin L4	11	App.5/Dwg.008Assembly-Spine-Torso Interface Pin L5	12	App.5/Dwg.013Assembly-Spine-Torso Interface Pin L6
13	App.5/Dwg.013Assembly-Spine-Torso Interface Pin L7	14	App.4/Dwg.014Torsion Thoracic Washer 10 Places	15	App.5/Dwg.009Assembly-Spine-Torso Interface Pin L8
16	App.4/Dwg.015Torsion Lumbar Washer	17	App.4/Dwg.012 Torsion Adjustment Washer 17 Places	18	App.4/Dwg.013 Torsion Bar 17 Places
19	App.5/Dwg.013Assembly-Spine-Torso Interface Pin R7	20	App.5/Dwg.013Assembly-Spine-Torso Interface Pin R6	21	App.5/Dwg.014Assembly-Spine-Torso Interface Pin R5

22	App.5/Dwg.011Assembly- Spine-Torso Interface Pin R4	23	App.5/Dwg.010Assembly- Spine-Torso Interface Pin R3	24	App.5/Dwg.012Assembly- Spine-Torso Interface Pin R2
25	App.5/Dwg.012Assembly- Spine-Torso Interface Pin R1				

1.4. Spinal Column - Muscle Substitute System

1.4.1. Assembly

The muscle substitute assembly is a system of springs and cables running through each vertebra from the occipital condyle plate to T3. Figure 5 shows a breakdown of the assembly; a list of the components is in Annex 2.

Figure 5
Muscle Substitute Assembly Components
(Refer to Appendix 6, Table 1)

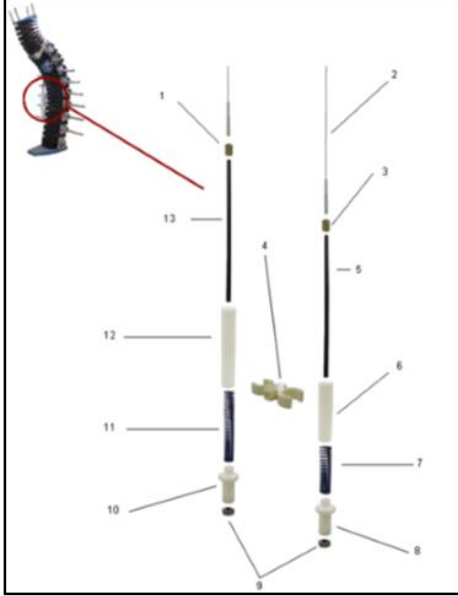
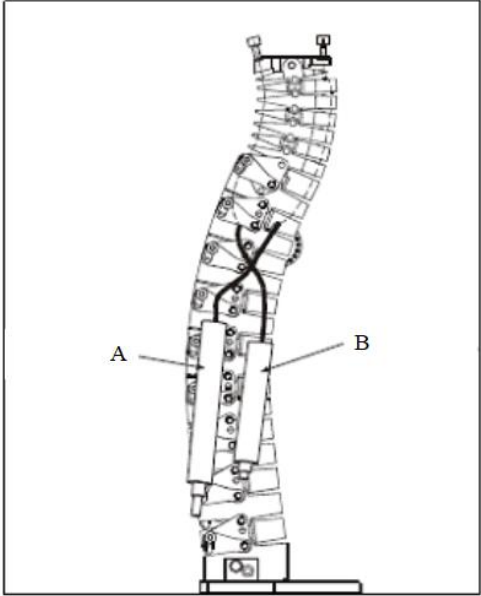
1	App.6/Dwg.020 Cable Terminal	2	App.6/Dwg.006 Cable, Spring with Terminal	3	App.6/Dwg.020 Cable Terminal
4	App.6/Dwg.022 Spring Tube Retainer	5	App.6/Dwg.019 Flexible Cable Sleeve	6	App.6/Dwg.014 Spring Tube-Posterior- Muscle Substitute
7	App.6/Dwg.013 Spring-Posterior-Muscle Substitute	8	App.6/Dwg.016 Piston-Muscle Substitute	9	M5-0.8 Jam Nut
10	App.6/Dwg.016 Piston-Muscle Substitute	11	App.6/Dwg.012 Spring-Anterior-Muscle Substitute	12	App.6/Dwg.015 Spring Tube-Anterior-Muscle Substitute
13	App.6/Dwg.019 Flexible Cable Sleeve	A	Posterior Muscle Substitute Assembly	B	Anterior Muscle Substitute Assembly

1.4.2. Disassembly

Prior to disassembly of the spine, the muscle substitute cables must be loosened or removed. The procedure for this is as follows.

1.4.2.1. Spring Loaded Muscle Substitutes:

Loosen and remove the two M5 nuts and lower spring cable adjusters at the base of each spring assembly and slide the springs out from the tubes.

Pull the cable through the adjustment screw at the top of the torso so that the cable crimp is accessible, and cut the cable below the crimp, between the crimp and the adjustment screw. Pull the cable down and out through the vertebrae and spring tubes.

1.4.2.2. Damper Loaded Muscle Substitute:

Loosen and remove the two M5 nuts and lower spring cable adjusters at the base of the spring assembly. Loosen the cable adjustment screws and posts at the top of the torso, on the dummy's left side, and adjust the posts all the way down.

Compress the cervical vertebrae toward the rear and pull the cable out of the rear adjustment screw, then cut the cable between the cable crimp and the adjustment screw. Repeat this procedure for the front adjustment screw. The cables shall be discarded and replaced.

Remove the damper mounting screw (M8-1.25 x 12 SHCS) located at T4 and remove the damper unit from the spine assembly. Loosen the two M3-0.5x10 SSCP that clamp the damper to the damper cable and remove the cable from the damper slot.

1.4.3. Cable Installation

Figure 6 is an exploded view of the upper neck components related to the three cables.

Figure 6
Cable Detail
 (Refer to Appendix 6, Table 1)

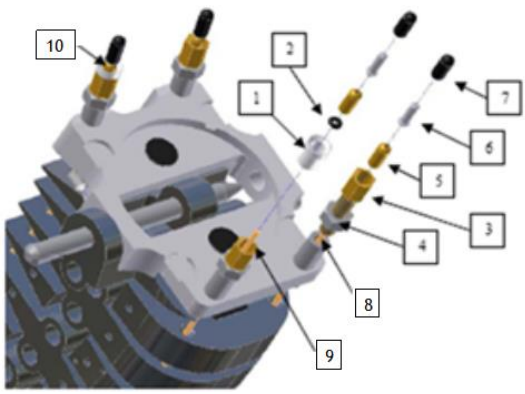

<u>Item No.</u>	<u>Description</u>	<u>Reference</u>	<u>Qty.</u>
1	Cable Post Lead-in screw	App.6/Dwg.023	2
2	Spring cable "O" ring		2
3	Upper cable adjuster	App.6/Dwg.017	4
4	M6 Hex locknut		4
5	Cable Ferrule		4

6	Cable cap		4
7	Cable Cap, Vinyl	App.6/Dwg.021	4
8	Damper cable	App.6/Dwg.018	1
9	Anterior cable	App.6/Dwg.006	1
10	Posterior cable	App.6/Dwg.006	1

1.4.3.1. Damper cable

Feed the damper cable through the top of the rear damper cable adjuster, and then through the back-cable holes of the vertebrae, from the occipital condyle plate down through T3 (Figure 7). After the cable is fed out through the damper cavity, feed it up through the front cable holes on the vertebrae, from T3 up through the front damper cable adjuster on the occipital condyle plate (Figure 8).

Set the damper adjustment screw so that it is ½ turn open by turning it clockwise until travel stops, then turning it counter-clockwise ½ turn (Figure 9).

Figure 7
Damper cable installation (1)
Damper cable indicated

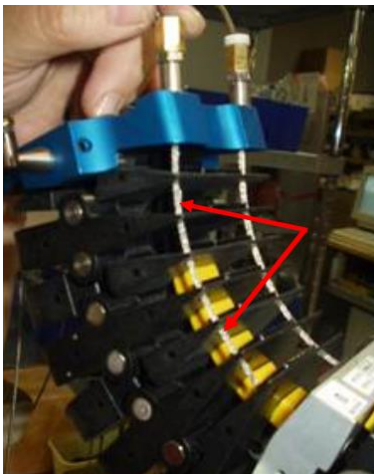

Figure 8
Damper Cable Installation (2)
1. Up Feed. 2. Damper Cavity

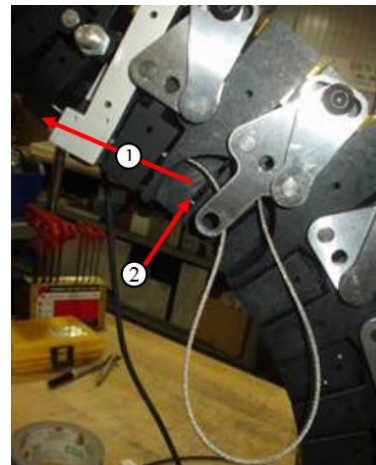
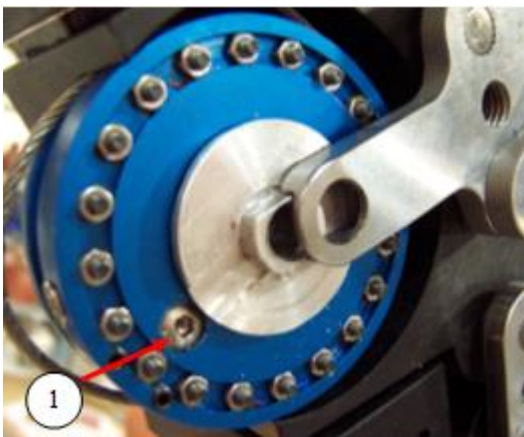

Figure 9
Damper Adjustment Screw setting



Overlap the cable as shown in Figure 10 and wrap the cable around the damper drum, making sure the cable is seated in the slot. Slide the tapered projection of the end of the damper paddle into the tapered slot on the mounting plate (Figure 11) and slide the clamp bracket over the damper/plate assembly (Figure 12). Ensure that the shallow slot on the seal washer and the mating projection on the clamp bracket are mated (Figure 13).

Install the M8 mounting bolt and lock washer until it is finger tight. Tighten the M3 setscrew to firmly seat the damper into the tapered slot on the mounting plate (Figure 14). Torque the mounting bolt to 6.78 Nm (Figure 15).

Figure 10
Damper Cable overlap

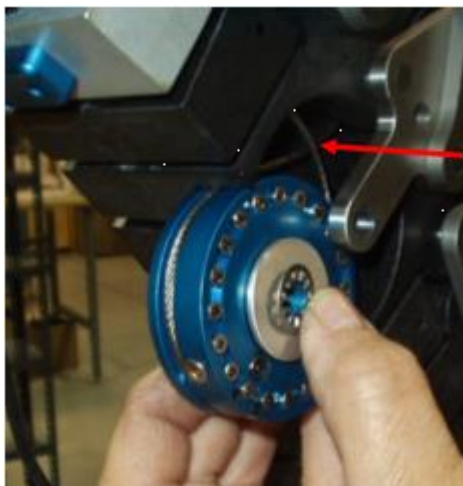

Figure 11
Slide damper into place



Figure 12
Install Damper Clamp Bracket



Figure 13
Damper Clamp Bracket mate

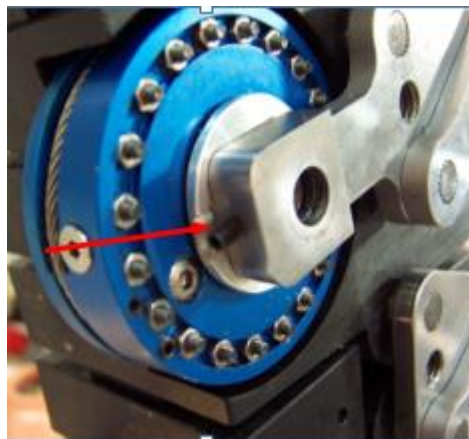

Figure 14
Damper Clamp Set Screw

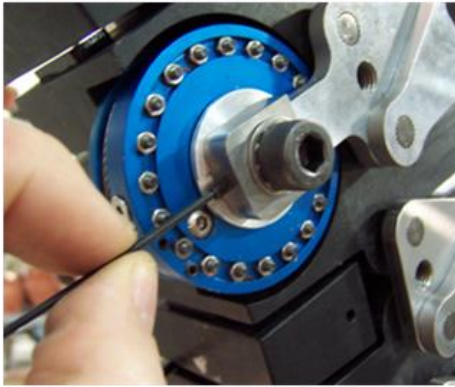
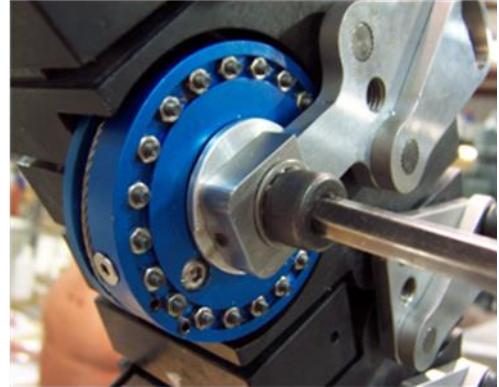

Figure 15
Damper mounting bolt.



Feed one ferrule onto the end of the rear damper cable (Figure 16) and crimp the ferrule within 100 mm of the end of the cable (Figure 17).

Feed one ferrule onto the end of the front damper cable (Figure 18). Ensure that the cable adjusters are adjusted all the way down, then pull up on both ends of cable with one hand so that the cable is seated tightly around the damper and so that the rear ferrule touches the top of the cable adjuster.

Crimp the front ferrule while both front and rear ferrules are touching the adjacent adjuster. Leave both damper adjusters adjusted all the way down.

Figure 16
Damper Cable Ferrule installation

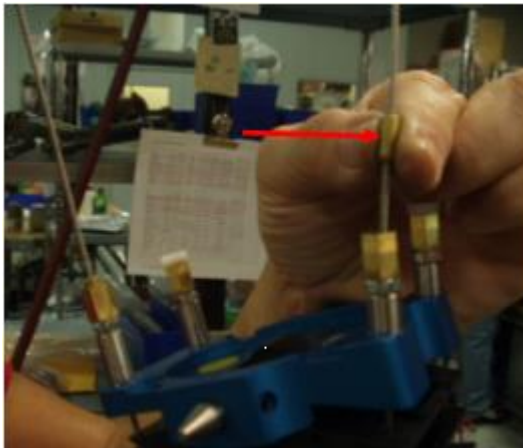

Figure 17
Ferrule crimping

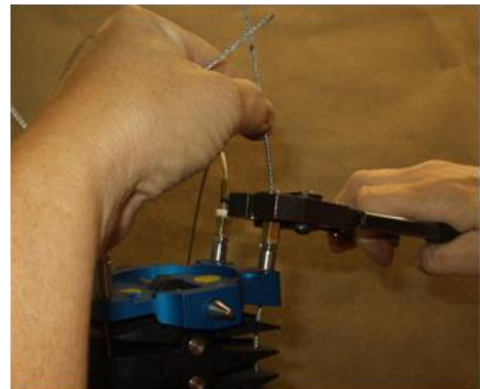
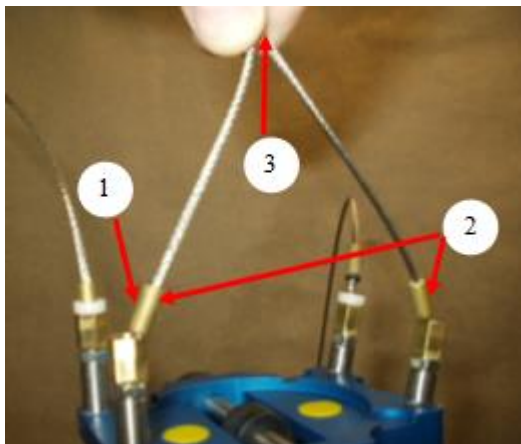

Figure 18
Damper Cable setting
1 – Front ferrule.
2 - Ferrule and adjuster touching
3 - Direction of pull.



1.4.3.2. Spring Cable

Feed the anterior spring cable (App.6/Drq.6), through the small cable hole at the top of the longer spring tube (Figure 19), and up through all vertebra from T3 to the occipital condyle plate. Feed the anterior spring onto the end of the cable (Figure 20) and install the lower cable adjuster onto the threaded stud (Figure 21) until the adjuster is flush with the end of the cable stud.

Figure 19
Anterior Spring Cable Insertion



Figure 20
Anterior Spring Insertion

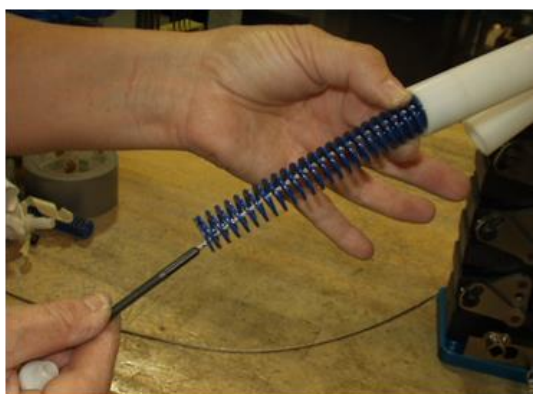
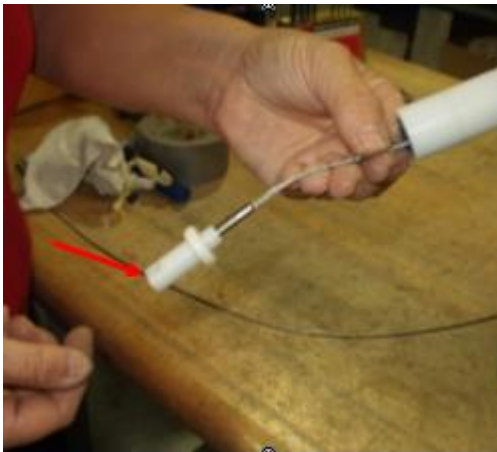

Figure 21
Cable Adjuster flush with stud end



Feed the posterior spring cable (App.6/Drg. 6) through the small cable hole at the top of the shorter spring tube and up through all vertebra from T3 to the occipital condyle plate. Feed the posterior spring onto the end of the cable, install the lower cable adjuster and turn it upward so that there is 16 mm protruding (Figure 22).

Ensure that both the front and the rear upper cable adjusters are adjusted all the way down. Install an O-ring on both front and rear spring cables, followed by the ferrules, as shown in Figure 23.

Pull the anterior cable up to remove any slack remaining in the cable. Slide the ferrule down until it touches the top of the cable guide App.6/Drg. 23 (Figure 24) and crimp the ferrule in place. Repeat this step for the posterior spring cable assembly.

Cut the ends of all four cables approximately 10mm above the ferrules. Place cable caps on all four cables ends and crimp them in place. Place 1 drop of cyanoacrylate locking adhesive on the sides of each of the 4 cable caps and install vinyl caps App.6/Drg. 21 over them. Squeeze the vinyl caps briefly to ensure they adhere to the cable caps

Figure 22
Setting the Posterior Spring Cable
 (Adjust up in the direction of green arrow)

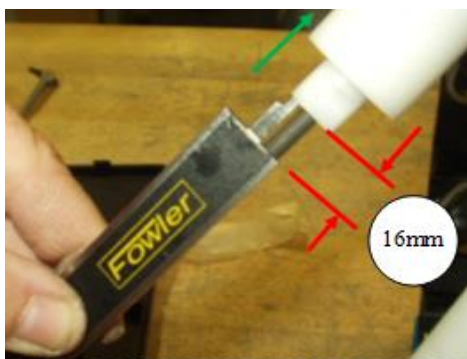

Figure 23
Ferrule Installation Front and Rear Spring Cable.

(Cable adjusters are all the way down – green arrow)

1. O-ring. 2. Ferrule

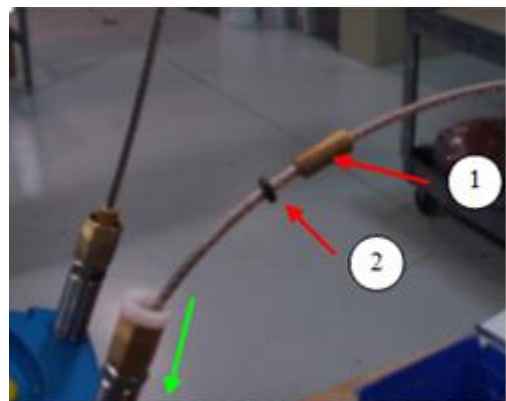
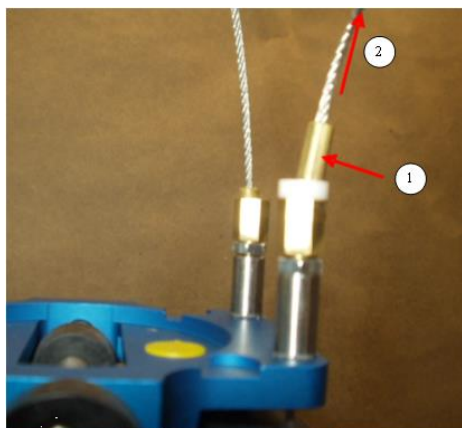

Figure 24
Remove Slack from Spring Cable
1. Ferrule and guide touching
2. Pull in direction of green arrow



1.4.4. Damper Removal and Installation

In addition to damper replacement or maintenance, it is necessary to remove the damper for maintenance work on the T1 load cell or for neck bumper replacement. The following are steps to remove and re-install the damper (App.6/Drg. 9). Figure 25 is an exploded view of the damper assembly.

Figure 25
Exploded View of Damper Assembly

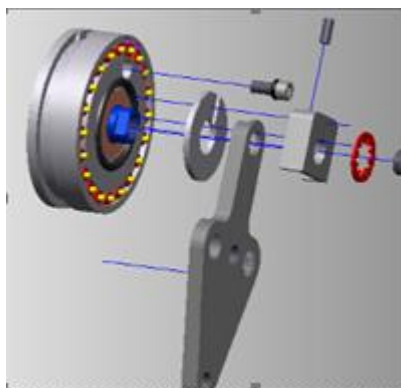

Loosen the locknuts on both adjusters for the damper cable, then turn the adjusters until they are at the lowest extremity of their travel, such that cable is as loose as possible (Figure 26). Loosen both the M3 cable clamping set screws to enable removal of cable from the mating slot on the side of the damper body (Figure 27).

Figure 26
Loosen Adjusters



Figure 27
Loosen M3 Clamping Screws



Back off the M3-0.5x8 (SSCP) setscrew by two turns (Figure 28). Remove the M8-1.25x16 damper mounting screw, then remove the Clamp Bracket (App.6/Drg. 3). Slide the damper towards the front of the spine (Figure 29), turn the damper to untwist cable (Figure 30) and disengage it from the cable.

When re-installing the damper, be sure that the cable overlap is correct; see Figure 31 for a view of the correct overlap direction. Engage the cable within the cable slot of the damper.

Slide the tapered projection of the paddle into the tapered slot on the mounting plate (Figure 32). If the parts will not mate, then the projection is out of position.

Slide the damper all the way into the mating slot on the plate, then slide the clamp bracket (App.6/Drg. 3) over the damper/plate assembly. After installing the clamp bracket, ensure that the shallow slot on the seal washer and the mating projection on the clamp bracket are mated. It may be necessary to rotate the washer to line-up the slot with the projection.

Install the M8-1.25x16 mounting bolt and lock washer with fingers until finger tight. Tighten the M3-0.5x8 Set Screw Coupling Plate (SSCP) screw to firmly seat the damper into the tapered slot on the mounting plate.

Figure 28
Back Off Set Screw

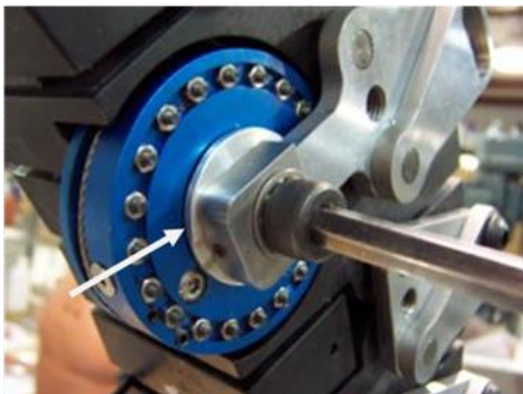

Figure 29
Slide Out Damper



Figure 30
Turn Damper and Disengage Cable

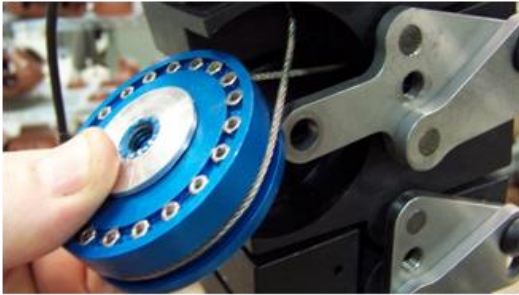

Figure 31
View of Correct Cable Overlap

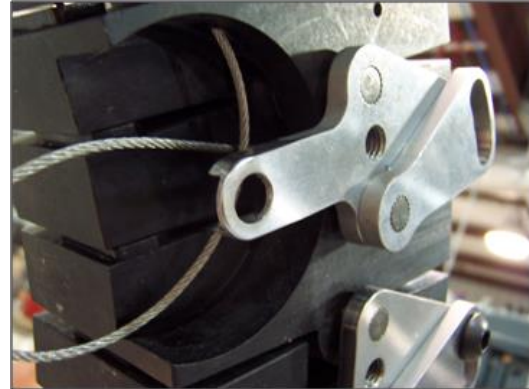
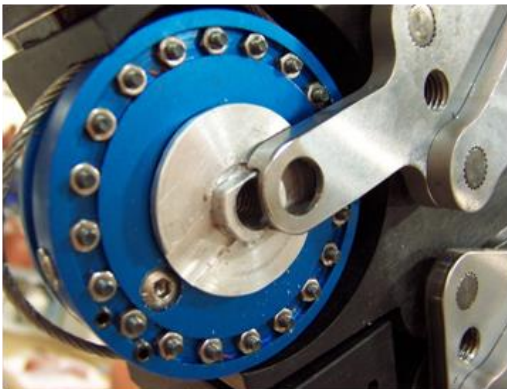

Figure 32
Install Damper



1.4.5. Damper Filling

Close the damper adjustment screw (turning it clockwise) to the full extent of its travel, and then open it (turning it anticlockwise) by 2 full turns (720 degrees).

Remove Damper fill hole cover screw, M3-0.5x6 FHCS (Figure 33).

Install the M8 mounting screw and tighten until it is finger tight; this screw will be used for turning the paddle to isolate air pockets in the damper. Turn the M8 mounting screw all the way clockwise. If it is found that the screw loosens during subsequent steps, it may be further tightened.

Using a syringe of ISO 680 damper oil, inject oil until it begins flowing out around the needle. After initial filling, it is then necessary to remove air pockets as follows:

By hand, turn the paddle very slowly anticlockwise while holding the damper in one hand. A steady drag will be felt when oil is passing through the orifice inside the damper. When an air pocket passes through the orifice, the drag reduces allowing the paddle to rotate with much less resistance. The smallest bubbles of air can be felt as small shock when they pass through the orifice.

After air is felt to pass through the orifice and the drag from the oil starts again, slowly turn the paddle back clockwise; the air will again be felt, but now the air pocket will be directly under the fill hole. Repeat filling with the syringe and stop when oil flows out around the needle. Repeat this process until the damper is free of air through the entire rotation travel of the damper.

The fill hole cover screw may be installed between each syringe application, to help avoid accidentally pumping oil out of the damper if it is rotated too fast.

Coat the tapered portion of the cover screw with a silicone sealant or equivalent. The sealant shall have a temperature range suitable for the region in which the dummy is to be used and, if appropriate, for the conditions to be encountered during transport. Silicone sealant containing copper is recommended (Figure 34). Install the fill hole cover screw tightly and wipe away the excess sealant.

Figure 33
Remove Oil Fill Screw



Figure 34
Add sealant to the cover screw



1.5. Static Spine Setup Procedure

The adjustments and tests described within this section shall be performed after any maintenance work (such as servicing or replacement of parts) is undertaken on the spine. The procedures within this section shall be carried out only in the sequence presented.

1.5.1. Thoracic and Lumbar Spine

Place the spine on a bench top and ensure that all 17-torsion washer locking screws are loose. Insert the thoracic and lumbar vertebra spacer tool (App.9/Dwg.020) into the front of the lower spine as shown in Figure 35. Ensure the inside edge of tool is within 1 mm of the fronts of all thoracic and lumbar vertebrae; use a soft faced hammer to tap up and down along outer edge of tool to ensure correct location. If necessary, use optional attachment handles to aid installation.

Tighten the locking screws (Figure 36), beginning at the S1 lumbar plate screw on the right side of the spine and continuing upward on right side. Use 20Nm torque for each screw except for the T1 thoracic plate screw (Figure 37), which requires only 14Nm. After all 9 screws on right side of spine are tight, tighten all 8 screws on left side of spine to 20Nm, beginning at the L5 lumbar screw and continuing upward until all are tight. Hold the bottom of the spacer tool against the pelvis interface plate while tightening the L5 lumbar screw to prevent the spine tilting backward due to the torque.

Remove the spacer tool by tapping with a soft faced hammer, toward the right side of the spine.

Figure 35
Thoracic and Lumbar Vertebra Spacer
(App.9/Dwg.017)
Tool (1) with Optional Cam Arms (2)

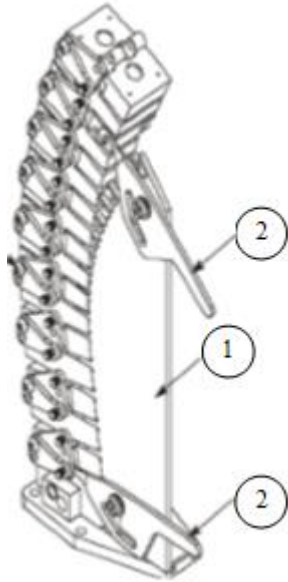

Figure 36
Tighten locking screws

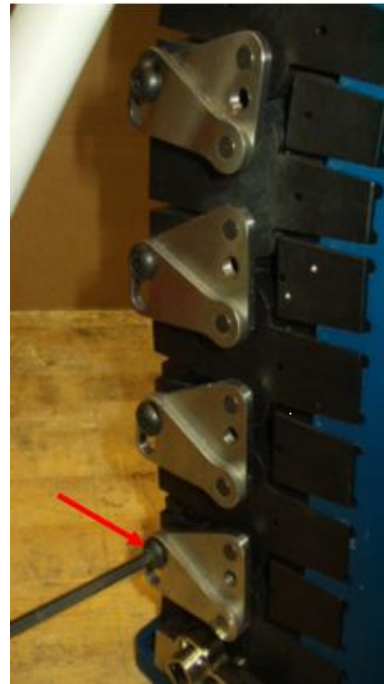
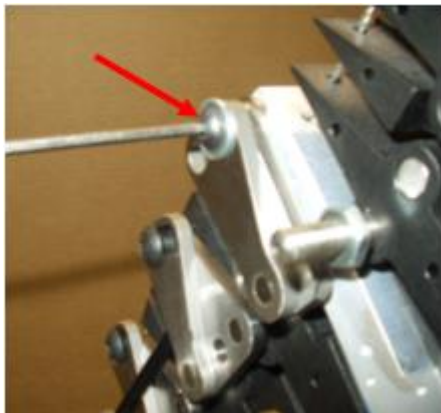

Figure 37
T1 thoracic plate screw



1.5.2. Cervical Spine Set-up (Pretension)

Place the spine on a bench top and ensure that the front and rear upper spring cable adjusters and the damper cable adjusters are set all the way down with the locknuts loose (Figure 38), and that the cable is not clamped to the damper.

Adjust the lower spring cable adjuster on the front spring until the bottom is flush with the end of the spring cable stud (the front spring is attached to the front of the occipital condyle plate and is the longer spring tube). Adjust the lower spring cable adjuster on the rear spring until the cable stud is protruding out from bottom of adjuster by 16mm (the rear spring is attached to the rear of the occipital condyle plate and is the shorter spring tube). This is shown in Figure 39.

Check the amount of slack in the spring cables by pulling them up at the point where they exit the upper cable adjusters (Figure 40) and allowing them to drop. Remove slack from the cables by turning the upper front and rear cable adjusters anticlockwise until no slack can be felt but with no tension in the cable.

After removing all slack, tighten both locknuts onto the upper spring cable adjusters.

Figure 38
Cable adjuster (1) and locknut (2)

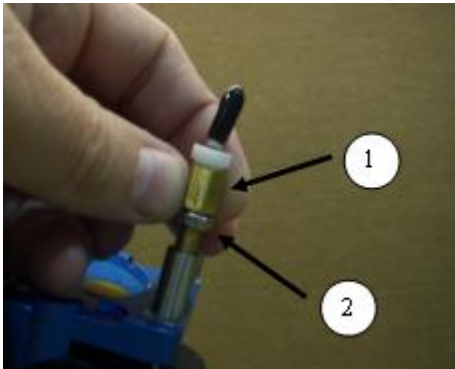

Figure 39
Front (1) and Rear (2) Spring Cable Adjusters

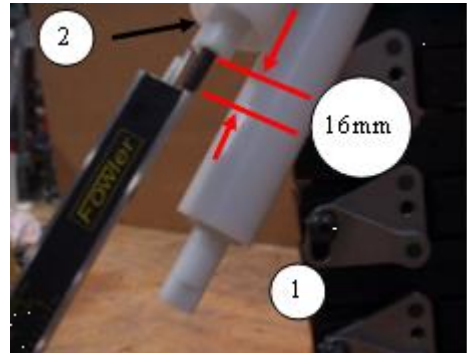
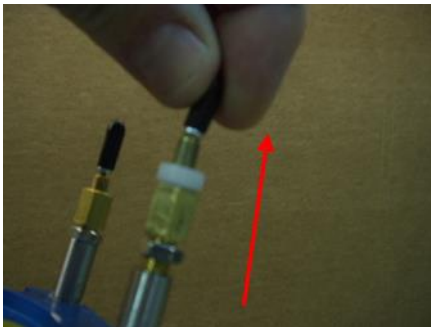

Figure 40
Check for Slack (Pulling-up)



1.5.3. Cervical Spine Setup (Tension)

This procedure is to be used only after removing the slack from the cables as described in 1.5.2.

Adjust the rear lower spring cable adjuster counter-clockwise (down) 10 mm so that the cable stud is now protruding by 6 mm (Figure 41). There should be 10mm free play in the rear cable. Next, adjust the front lower spring cable adjuster clock-wise (up) so that cable stud is now protruding 24 mm instead of flush. (Figure 42). This will leave an overall bias of 14mm (24mm added, 10mm subtracted).

Place the locknuts on both cable studs and lock them against the spring cable adjusters, as shown in Figure 43, then push up on the ends of both lower cable adjusters to release any twist in the cables that may have resulted from cable adjustments. Check that the length by which the cables protrude remains at 6mm (rear cable) and 24mm (front cable).

Figure 41
Rear lower spring cable
 – adjust down (1)

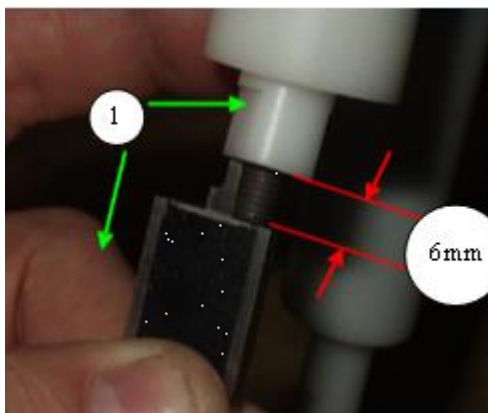

Figure 42
Front lower spring cable adjustment

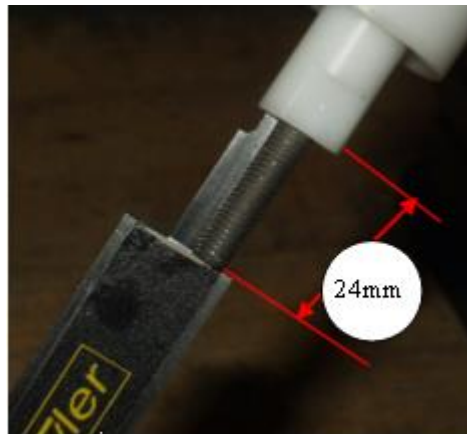

Figure 43
Lock the Spring Cable Adjusters



Place a digital inclinometer on the top of the spine/pelvis interface plate in the orientation illustrated in Figure 44, and zero it. Grasp the occipital condyle plate with both hands and force the plate to tilt it down to the front, such that the front spring and bumpers will force the plate to return upward to settle to a new stationary position. After allowing the occipital condyle to remain in this position for 30 seconds, measure the angle about the y axis (i.e. forward rotation) on the plate (Figure 45). This angle shall not be less than 30 degrees. If this condition is not achieved, reset front and rear springs at lower adjusters to values shown in Figure 46, then repeat the test in this paragraph.

Figure 44
Zero Digital Inclinometer



Figure 45
Tilt the occipital condyle plate down to the front



Figure 46
Front (left) and Rear (right) Spring Adjustment if front angle cannot be held with original values

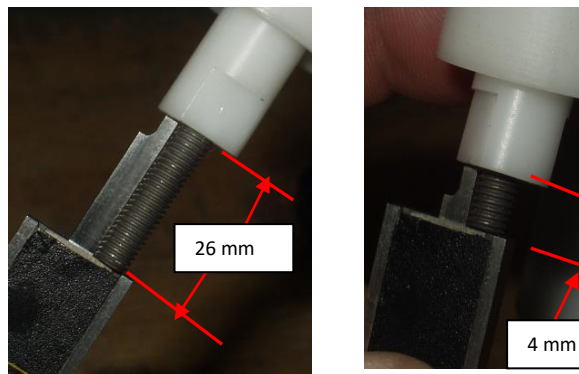

Grasp the occipital condyle plate with both hands and use force to tilt the plate down to the back, to the degree that the rear spring and bumpers will force the plate to return upward to a new position. After allowing the plate to remain in this position for 30 seconds, measure the angle about the y axis on the plate (Figure 47). This angle shall not be more than 26 degrees. If this angle cannot be held, reset front and rear springs at lower adjusters to values shown in Figure 48 and repeat the test in this paragraph. If the angle still cannot be held, check the front 8 cervical bumpers (App.3/Drg. 13). Refer to section 3 for bumper maintenance procedures.

Once the correct adjustment of the occipital condyle plate is confirmed, re-lock the cable stud locknuts.

Figure 47
Tilt OC Plate down at the back



Figure 48
Front and Rear Spring Adjustment if back angle cannot be held

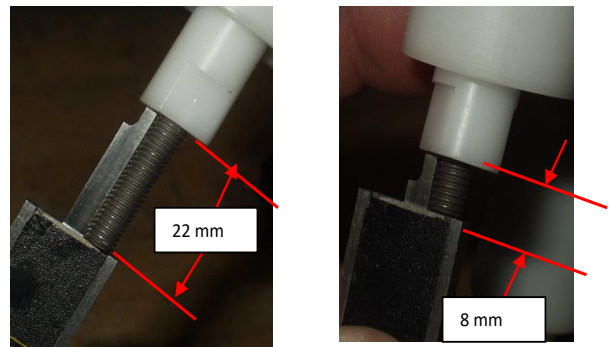

1.5.4. Damper Cable Adjustment

With the spine adjusted and positioned according to paragraph 1.5.3., adjust the damper cable adjusters (Figure 49) upward until tension is added to damper cable around damper drum, then clamp the cable to the damper with both M3 set screws (Figure 50).

Place a digital inclinometer laterally across the occipital condyle plate, as shown in Figure 51, and add tension to the damper cable using both cable adjusters, until the angle across the plate is zero +/- 0.5 degrees. Once the angle is correct, tighten both locknuts on the damper cable adjusters and leave the spine in position for the next step.

Figure 49
Damper cable adjusters



Figure 50
Damper adjustments.
(1) Damper adjustment screws
(2) M3 set screws

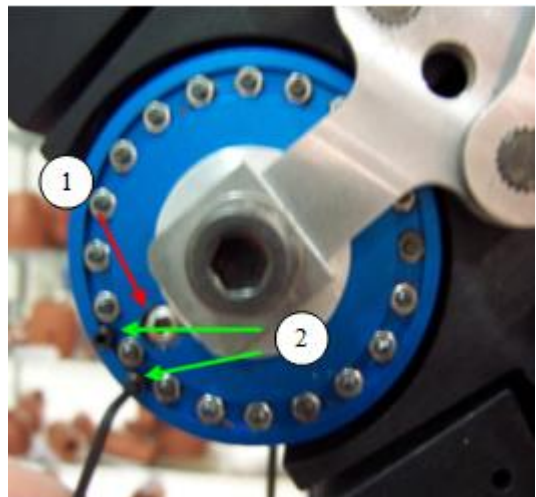
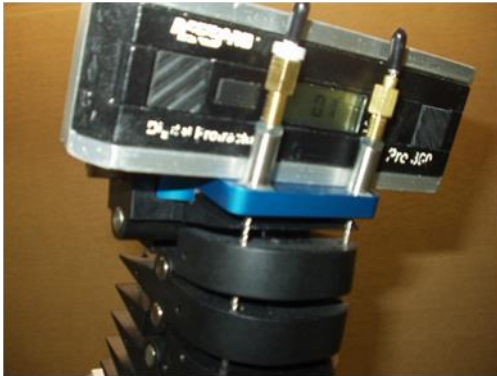

Figure 51
**Occipital condyle plate lateral
 angle setting**



1.5.5. Static Spine Measurements

Static spine measurements are used to ensure that the posture of the dummy is correct; Figure 52 shows a summary of these measurements. The measurements shall be verified after any maintenance or adjustment of the spine or muscle substitute assembly, and during certification of the dummy. Record the measurements that are taken.

Figure 52
Spine set-up measurements

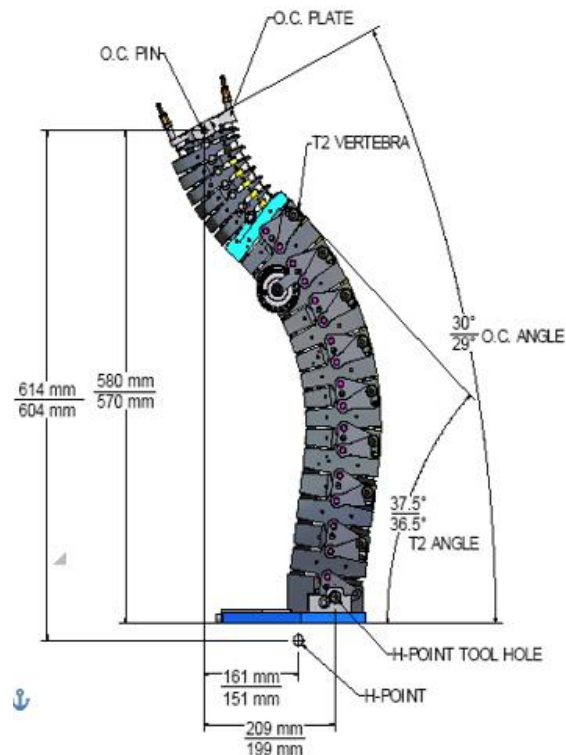

Commence this step with the dummy in the position obtained during procedure described in section 1.5.3. By hand, force the occipital condyle plate to an angle between 29-30 degrees of forward tilt (about the y-axis). The plate will hold this angle with the damper in the system (Figure 53).

Measure the Z dimension from the centre of the occipital condyle pin to the bottom of the spine/pelvis inter-face plate (which contacts the bench top). This

dimension shall be 575 +/- 5mm. Alternatively, measure the Z dimension between the pin and the H-point; this dimension shall be 609 +/- 5 mm.

Measure the X dimension from the centre of the occipital condyle pin to the centre of the H-point tool square insertion hole. This dimension shall be 204 +/- 5 mm. Alternatively, measure the X dimension from the centre of the pin to the H-point; this shall be 156 +/- 5 mm.

Using a digital inclinometer, verify the angle on the rear of T2 vertebra at 37 +/- 0.5 degrees (Figure 54); if this is not achieved, adjust the spine position within the allowable tolerances and repeat the measurements within this section until the correct angle is achieved.

If a spine position satisfying all the required dimensions cannot be achieved, the spine does not conform to the BioRID-II UN specification.

Figure 53
Occipital Condyle Plate angle setting



Figure 54
T2 angle setting

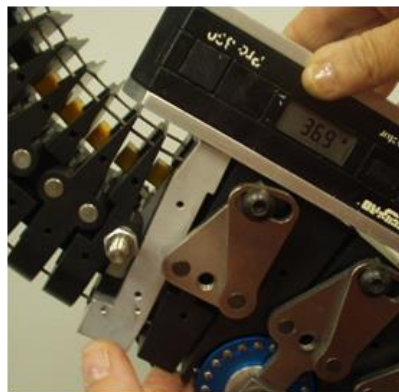

1.6. Torso Flesh and Lifting Bracket

1.6.1. Assembly

Figure 55 shows a breakdown of the jacket and lifting cable assemblies. The components are listed within Annex 2.

Figure 55
Torso Flesh and Lifting Bracket assembly components
(Refer to Appendix 5, Table 1 and Appendix 9, Table 1)

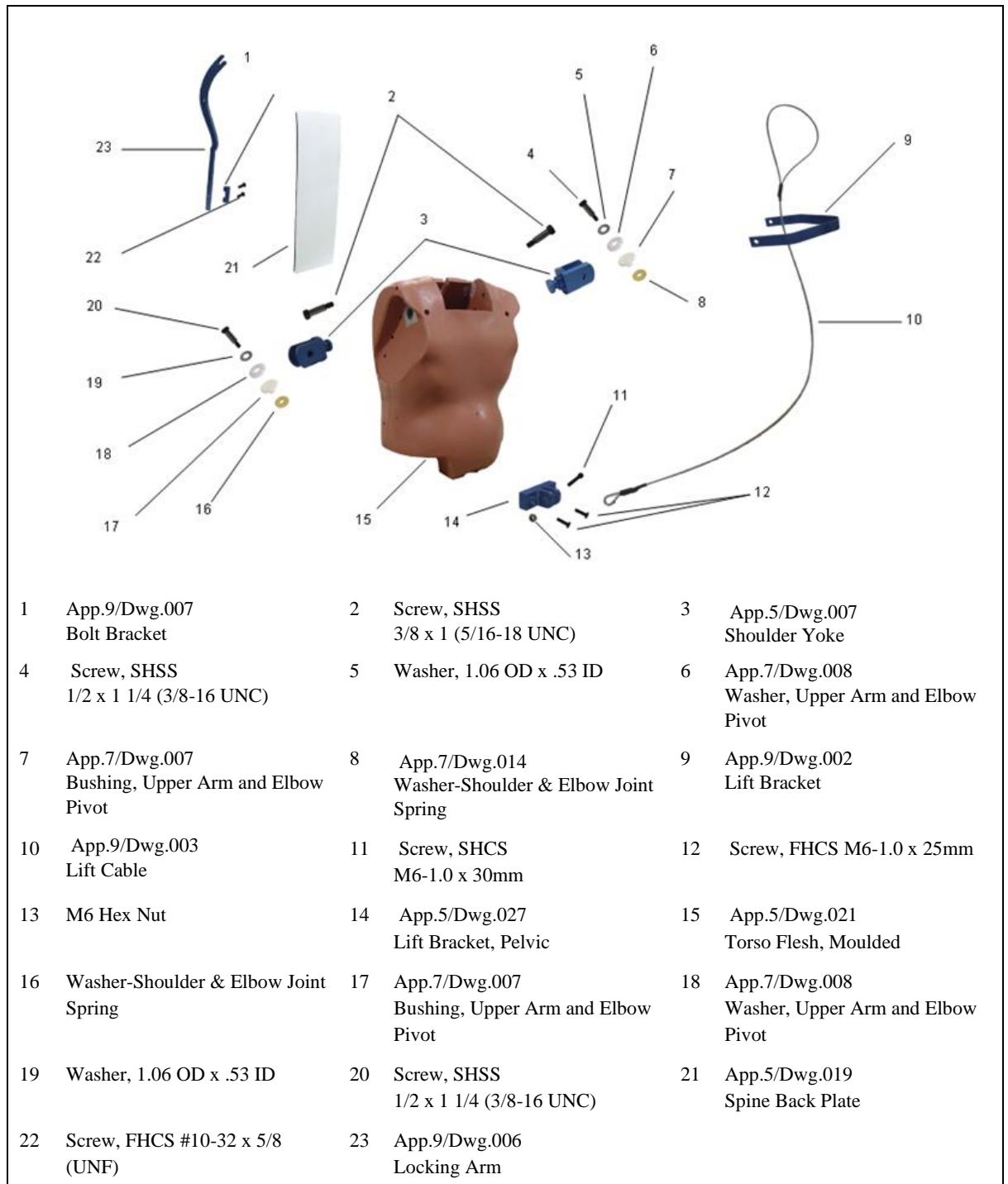

1.6.2. Removal

To separate the upper torso from the pelvis and legs, remove the two M10- 1.5 x 45 mm SHCS located at the rear of the pelvis structure and the M10-1.5 x 45 mm SHCS located at the front, accessed through the bottom of the pelvis. The pelvis and legs can then be pulled away from the upper torso

Remove the arms by taking out the 3/8" x 1 1/2" (5/16-18 UNC) SHSS located on the front of the torso at the shoulder pivot and pull the shoulder yoke and arm assembly away from the upper torso as one unit.

After both arms are removed from the upper torso, the torso flesh can be removed. Take out the back plate from the rear of the torso flesh, remove the two M6-1.0 x 25 FHCS located at the base of the upper torso flesh in the front of the dummy, and take out the interface pins along each side of the torso (these are the fifteen pins that connect the spine and torso). Lay the upper torso on a clean, flat surface with the chest down and loosen the upper four screws (two on each side) with an M6 Allen key, then remove the remaining screws with an M4 Allen key. Pull the spring-loaded muscle substitute assemblies (2 pieces) from their holder in the torso flesh, then pull the flesh away from the spine assembly.

1.6.3. Abdomen Filling Procedure

The abdomen must be filled with a precise quantity of water when used for testing. (To avoid damage from freezing the BioRID-II UN dummy (and jacket) are shipped with the abdomen drained of water.)

The abdomen shall be filled with fresh water through the valve on the left side of the torso flesh (Figure 56). A 4-litre bottle with a metre-long hose and a 2.11mm (14-gauge) diameter, blunt-end, needle shall be used to fill the abdomen. The needle shall have an internal diameter of 1.7mm and a length of between 25 & 38mm.

Figure 56
Location of the Abdomen Fluid Valve (1)

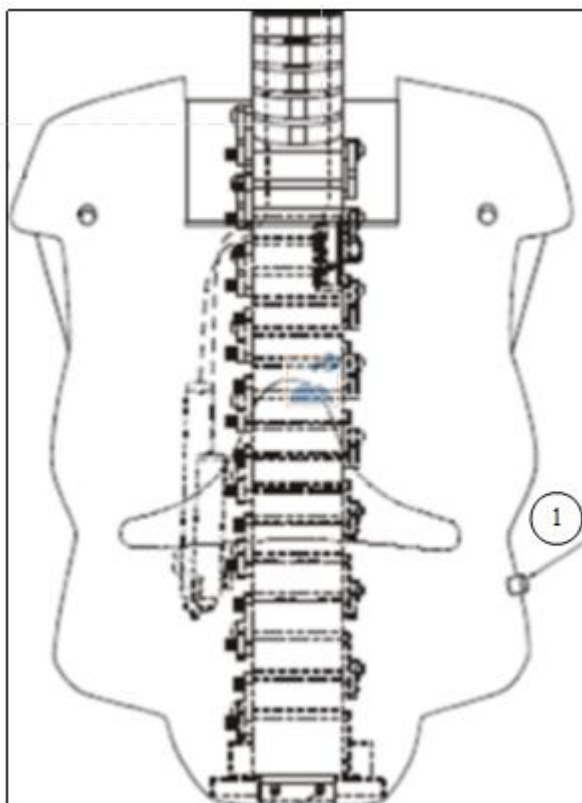

Fill the bottle with the required 2.06 litres of fresh water. The spigot valve must be closed. Lay the torso down with the abdomen filling valve pointed upward, then remove the plastic cap covering the valve and take out the valve core; this can be achieved using a generic valve core tool.

Insert the needle into the valve opening. Holding the bottle and hose assembly above the abdomen, open the spigot on the bottle. Empty all the water from the bottle and the hose into the abdomen and then remove the needle from the valve. Do not over fill.

Reinstall the valve core. Depress the valve core and gently squeeze the abdomen to remove all the remaining air. Water will be visible in the valve when all the air is removed. It may be necessary to do this step several times while tilting the torso in different directions. Reinstall the plastic valve cap to complete the procedure.

After finishing the filling procedure, the total mass of the jacket and 15 spine/torso connection pins must be verified to be 21.87 kg +/- 0.26 kg.

1.7. Pelvic Assembly

1.7.1. Assembly

BioRID-II UN uses a modified Hybrid III 50th Percentile pelvis. The assembly consists of the moulded pelvis structure, the femur assemblies (left and right) and two femur friction plungers used to apply force to the femur ball and provide resistance to leg motion. Figure 57 shows a breakdown of the components, which are listed within Annex 2.

Figure 57
Pelvic Assembly Components
(Refer to Appendix 5, Table 1)

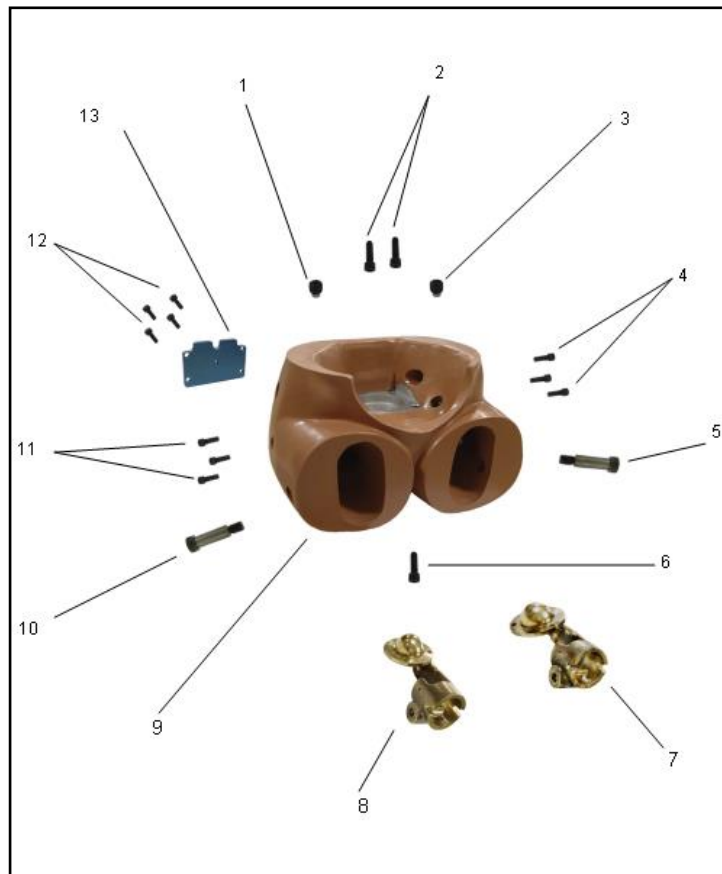

1	App.7/Dwg.008 Set Screw Assembly	2	Screw, SHCS M10-1.5 x 45	3	Set Screw Assembly
4	Screw, SHCS 1/4-20 x 3/4 (UNC)	5	Screw, SHSS 5/8 x 1-3/4 (1/2-13 UNC)	6	Screw, SHCS M10-1.5 x 45
7	Femur Assembly, Left, w/o bumper	8	Femur Assembly, Right, w/o bumper	9	App.5/Dwg.025 Pelvis, Moulded, RID
10	Screw, SHSS 1/2-13 x 1-3/4 (UNC)	11	Screw, SHCS 1/4-20 x 3/4 (UNC)	12	Screw, SHCS #10-24 x 1/2 (UNC)
13	Pelvic Cavity Cover				

1.7.2. Disassembly

Remove the 5/8 x 1-3/4" SHSS (1/2-13 UNC) in the pelvis that secure the legs in the femurs and remove the legs. Take out the three 1/4-20 x 3/4" SHCS (UNC) that secure each femur flange to the pelvis bone and remove the femur assemblies. Check the femur ball for damage or metal deposit build-up.

1.8. Arms

1.8.1. Assembly

BioRID-II UN uses Hybrid III 50th percentile Male Dummy arms. Figure 58 shows a breakdown of the components in a left arm assembly. The components are listed within Annex 2.

Figure 58
Arm Assembly components (left arm shown)
(Refer to Appendix 7, Table 1)

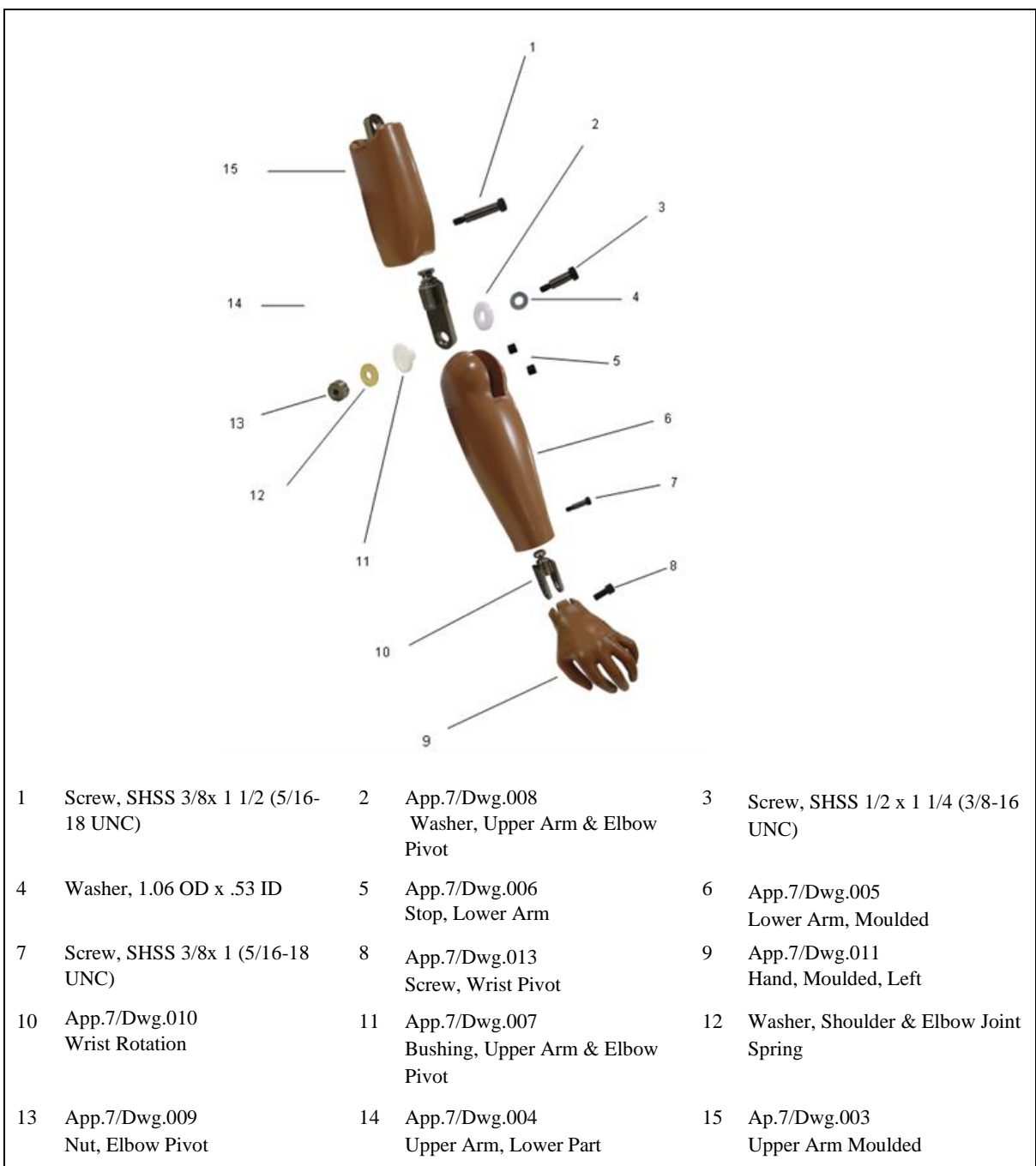

1.8.2. Disassembly

Remove the 1/2 X 1 1/4" SHSS (3/8-16 UNC) bolt and associated washer at the elbow joint and remove the lower arm assembly by rotating the lower arm rearward. Within the elbow joint are the pivot washer, pivot bushing, pivot nut and spring washer. Check each component for damage and replace as necessary.

To separate the lower part of the upper arm, take out the 3/8X 1-1/2" SHSS (5/16-18 UNC) in the upper arm section, just above the elbow. The upper arm assembly can then be pulled from the upper arm lower part. The upper arm lower part is the component that is inserted into the elbow joint.

The moulded hand is detached from the lower arm assembly by taking out the wrist pivot screw (modified 1/2-20 x 1-1/8" SHCS UNF – App.7/Dwg.013) and pulling the hand from the wrist assembly. The wrist assembly is removed by taking out the 3/8X 1" SHSS (5/16-18 UNC) and pulling the wrist assembly from the lower arm.

1.9. Legs

1.9.1. Assembly

The BioRID-II UN dummy uses Hybrid III 50th Male Dummy legs with the knee sliders replaced by pedestrian blocks. Figure 59 shows a breakdown of the components in a left leg assembly; a list of these components is within Annex 2.

Figure 59
Leg Assembly components (left leg shown)
(Refer to Appendix 8, Table 1)

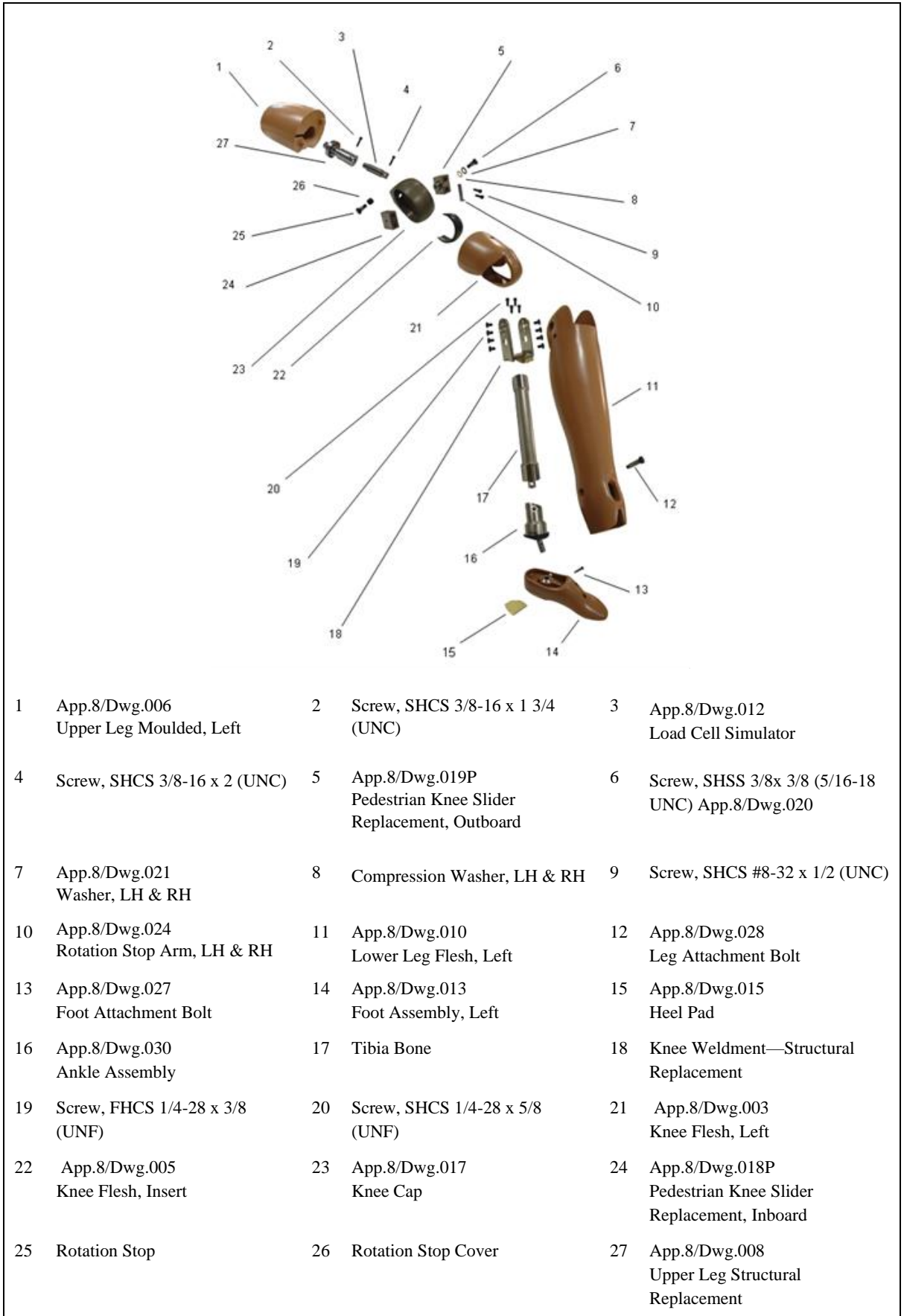

1.9.2. Removal

To detach the upper and lower leg sections, pull the flesh flaps away from the knee section and take out the four modified 1/4-28 x 3/8" FHCS (UNF) on each side of the knee (i.e. a total of 8 per leg), then slide the knee clevis off the knee assembly.

To disassemble the upper leg assembly, take out the 3/8-16 x 1-3/4" SHCS (UNC) at the top of the assembly toward the knee end, then pull the knee assembly away from the thigh.

The femur load cell is installed between the knee and thigh and can be removed by taking out the 3/8-16 X 2" SHCS (UNC) in the knee assembly. With the knee detached, the femur flesh can be slid off the upper femur bone by pushing it toward the knee.

To disassemble the knee assembly, take out the knee pivot bolt (modified 3/8" x 3/8" (SHSS) (5/16-18 UNC) (App.8/Dwg.020) at the pivot centre of the knee slider replacement assembly. There are two washers used with this bolt; one is steel, and one is synthetic. Upon reinstallation the synthetic (compression) washer shall be installed into the lateral (outer surface of the knee) pedestrian block first, and then the steel one inserted after this. Do not reverse the sequence upon reinstallation, or the synthetic washer will be damaged.

There is also a rotation stop installed on the lateral side of the knee bone. The stop consists of a modified 3/8 x 3/8" SHSS (5/16-18 UNC) (App.8/Dwg.020) and a rubber sleeve. The stop is removed by taking out the 3/8" screw and pulling the sleeve off the shoulder. The threads of the screw must not extend into the inboard knee slider replacement rotation path.

The knee flesh is removed by holding the knee bone and peeling the flesh off the outer knee radius (the impact surface). The knee insert (the black rubber part between the flesh and the knee bone) can be taken off the knee bone at the same time as the flesh. Inspect the flesh and insert for damage.

To take off the moulded foot assembly, take out the modified 1/4 x 3/4" SHSS (10-24 UNC) (App.8/Dwg.027) at the foot-ankle joint. With the foot removed, the lower leg flesh may be slid down the tibia toward the ankle to remove it.

Remove the knee clevis by taking out the four 1/4-28 x 5/8" SHCS (UNF).

To disassemble the ankle, take out the leg attachment bolt and pull the ankle off the lower leg assembly. Take out the 5/16-18 x 3/8" SSCP (UNC) and the friction pad to remove the force on the ankle shaft. Remove the two #10-32 x 1/4" SSCPs (UNF) holding the stop pin retainer in place and pull out the pin retainer, allowing the stop pin to fall out of the assembly. Take out the six #8-32 x 1/2" BHCS (UNC) that connect the upper and lower ankle shells. Four of these screws hold the ankle bumper in place and two are under the pad. Before reassembling the ankle, make sure the ankle shaft and inside surfaces of the shells are clean and free of burrs.

If a lubricant is necessary, use only graphite or equivalent dry products.

1.10. Joint Adjustment Procedure

The joints of the dummy shall be adjusted to a "1g suspended setting." This is defined as a torque level on the joint where the friction will allow an assembly to move toward the earth when a small force is applied to the unsupported end of the assembly, but where the friction is sufficient to support the assembly when it is static, and no external forces are applied. For example, when the dummy's arm is fully extended laterally so it is perpendicular to the body, the shoulder yoke clevis bolt must be tight enough to support the weight of the arm, but loose enough so that when the dummy's wrist is given a light tap, the whole arm will slowly fall towards the dummy. Multiple iterations of the testing and adjustment are likely to be required in each instance.

1.10.1. Joint adjustment - Arms and Hands

Extend the complete arm laterally outward to a horizontal position at the side of the dummy. Twist the arm so the elbow faces downward, to ensure the elbow cannot rotate downward under gravity. Tighten the shoulder yoke clevis bolt to achieve a 1g suspended setting.

Rotate the complete arm assembly so it points forward and is horizontal (i.e. is parallel to the X coordinate direction). Twist the arm so the elbow cannot rotate downward. Adjust the shoulder yoke rotation hex nut (Figure 60) to achieve a 1g suspended setting.

Bend the elbow 90 degrees so the lower arm is vertical and pointing upwards, then rotate the arm so that the upper arm is horizontal in front of the chest, maintaining the 90 degrees elbow bend. Adjust the elbow rotation bolt through the access hole in the upper arm (Figure 61) to hold the lower arm in a 1g suspended setting. Note that the Figure shows the arm positioned for convenient bolt access, not in the position for the 1g suspended setting test.

Reposition the arm so that the upper arm is pointing downward and slightly forward, and the lower arm is horizontal and facing forward, as shown in Figure 62. Adjust the elbow pivot bolt through the access holes in the lower arm flesh at the elbow to achieve a 1g suspended setting.

Extend the arm and twist the palm so it faces down. Adjust the wrist pivot bolt at the base of the hand to achieve a 1g suspended setting. Rotate the palm to the thumb up position and rotate the wrist 90 degrees so that the palm faces the torso. Adjust the wrist rotation bolt through access in the wrist flesh (Figure 63) to achieve a 1g suspended setting.

Repeat procedure for other arm and hand.

Figure 60
Shoulder joint setting



Figure 61
Access hole for the elbow rotation bolt

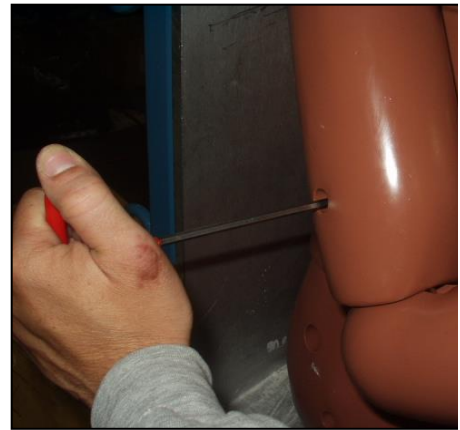
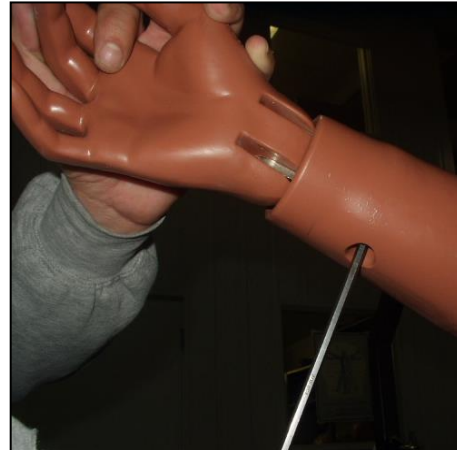

Figure 62
Adjusting the elbow pivot bolt



Figure 63
Adjusting the wrist rotation bolt



1.10.2. Joint adjustment - Legs and Feet

Remove the abdominal insert. With the lower leg at 90 degrees to the upper leg and the dummy in a seated position, lift the upper leg assembly above horizontal. Adjust the femur ball set screw (Figure 64) to achieve a 1g suspended setting.

Rotate the lower leg assembly so it is horizontal, i.e. the leg is straight and pointing forwards. Adjust the knee clevis bolt (Figure 65) to achieve a 1g suspended setting.

The ankle adjustment is not critical, but it should be adjusted as close as practical to a 1g suspended setting. Adjust the ankle ball joint set screw (Figure 66) and establish the 1g setting by individual feel.

Repeat procedure on other leg and foot.

Figure 64
Adjusting the Femur Ball Set Screw

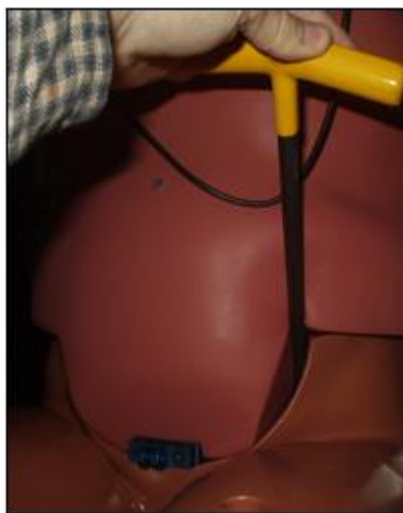

Figure 65
Knee joint setting



Figure 66
Ankle joint setting



1.11. Clothing

1.11.1. Shirts and Shorts

The BioRID-II UN clothing consists of two pairs of shorts and two shirts, made of a stretchable synthetic fabric containing both nylon and an elastomer fibre made from polyurethane; these two fibre types shall account for most of the overall fabric. This fabric has a shiny texture on one side and a matt texture on the other. The clothing shall be placed upon the dummy in two layers such that the shiny sides of the material comes face to face with each other.

1.11.2. Shoes

The BioRID II-UN Shoes are of the men’s dress oxford type in US size 11 extra wide, meeting military specifications MILS-13192P. Each shoe has an overall length of 320-325mm.

2. Instrumentation

2.1. Head Assembly

2.1.1. Assembly Components

The BioRID-II UN head is equipped to accept three uni-axial accelerometers mounted on a block to measure acceleration in the x, y and z coordinate directions at the head centre of gravity. Table 1 summarizes the parts used for instrumentation in the head. Figure 67 shows the orientation of the accelerometers with respect to the head.

Table 1
Head instrumentation parts

<i>Part Description</i>	<i>Quantity</i>
Uni-axial Piezoresistive Accelerometer	3
#0-80 x 1/8" SHCS (UNF)	6
Tri-axial Mount Block	1
#2-56 x 5/8" SHCS (UNC)	2

Figure 67
Head accelerometer orientation

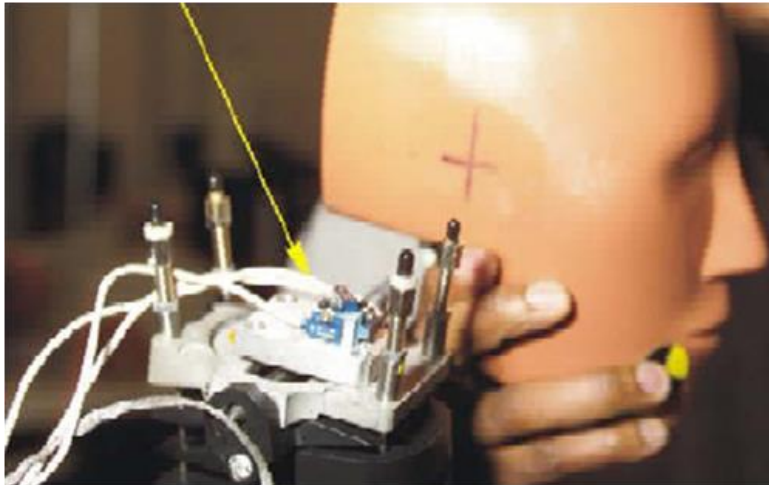

2.1.2. Installation

The three uni-axial piezoresistive accelerometers shall be mounted onto the tri-axial mount block (Figure 68) with two #0-80 X 1/8" SHCS (UNF) per accelerometer (6 total) so that their seismic masses all point to one corner of the block. The tri-axial block shall be attached to the head mounting block using two #2-56 X 5/8" SHCS (UNC).

The head mounting block shall be attached to the upper neck load cell (or upper neck load cell structural replacement) using four #10-24 X 7/16" SHCS (UNC). The upper neck load cell or upper neck load cell structural replacement shall be inserted into the head cavity.

Figure 68
Head accelerometers installed on triaxial mount block

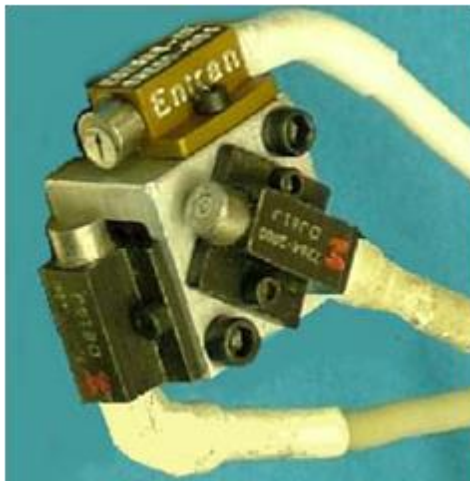

2.2 Spinal Column – Cervical portion

2.2.1. Assembly Components

The BioRID-II UN dummy shall be equipped with the following neck instrumentation: an upper neck load cell measuring X, Y and Z forces and moments, a lower neck load cell at T1 measuring Fx, Fz and My, and two uni-axial piezoresistive accelerometers at T1. Accelerometers may be located on the right or left side of the cervical vertebrae. If fitted, angular rate sensors may also utilize the accelerometer mounting on the cervical vertebrae.

2.2.2. Mounting of Accelerometers

Cervical spine accelerometers shall be mounted on the sides of the accelerometer block and shall measure Ax and Az accelerations when the block is mounted on the spine. Two uni-axial piezoresistive accelerometers shall be mounted onto the tri-axial mount block with two each #0-80 X 1/8" SHCS (UNF) (4 total) such that their seismic masses point to one corner of the block as shown in Figure 71.

Figure 71

Cervical Spine Accelerometer Mounting



2.3. Spinal Column - Thoracic and Lumbar Portions

2.3.1. Assembly Components

The BioRID-II UN dummy is equipped with two uni-axial piezoresistive accelerometers located at both the eighth thoracic vertebra and the first lumbar vertebra (4 accelerometers in total), measuring Ax and Az accelerations, and a lumbar load cell measuring X and Y axial forces and moments about Y axis. Accelerometers may be located on the right or left side of the thoracic vertebrae. Angular rate sensors may also utilize the accelerometer mounting on the thoracic vertebrae.

2.3.2. Mounting of Accelerometers

Thoracic spine accelerometers, if fitted, shall be mounted only on the sides of the accelerometer block, and when mounted to the spine shall measure Ax and Az accelerations. Two uni-axial piezoresistive accelerometers shall be mounted onto the tri-axial mount block with two each #0-80 X 1/8" SHCS (UNF) (4 total) so that their seismic masses all point to one corner of the block as shown for the cervical spine accelerometer mounting in Figure 71. This step is identical for T8 and L1 accelerometer locations.

2.4. Pelvis

2.4.1. Assembly components

BioRID-II UN is equipped with an instrumentation cavity in the back of the pelvis for the installation of accelerometers, angular rate sensors, and/or tilt sensors to measure the pelvis Ax, Ay and Az accelerations, and the AVx, AVy and AVz angular rates. These instruments are not required for regulatory use but may be fitted as options.

2.4.2. Mounting of accelerometers

Three uni-axial piezoresistive accelerometers shall be mounted onto the tri-axial mount block with two each #0-80 X 1/8" SHCS (UNF) (6 total) so that their seismic masses all point to one corner of the block (Figure 72).

Figure 72
Pelvis accelerometer mounting

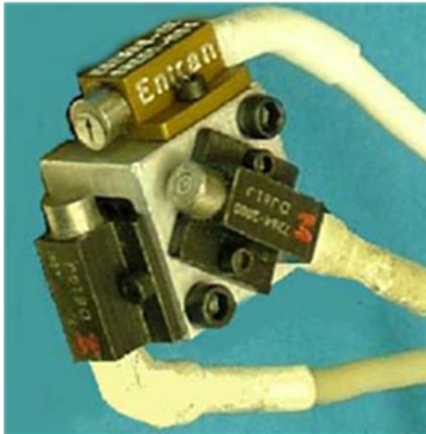

The tri-axial block shall be attached to the pelvis accelerometer mounting plate using two #2-56 X 5/8" SHCS ((UNC). The pelvis mounting plate shall be attached to the pelvis instrumentation cavity.

2.5. Cable Routing

The instrumentation cables must be routed in and around the dummy in a manner that ensures that the dummy's motion is not affected by the cables and that the cables are not in a position where they are susceptible to damage from the test event.

2.5.1. Grounding

To reduce the possibility of static electricity discharge and subsequent noise in the data acquisition system, the metal bodies of the accelerometers and load cells shall be electrically connected to the ground. Figure 73 shows a typical grounding scheme. It shall be ensured that there are no electrical ground loops in the system.

Figure 73
Suggested instrumentation grounding scheme

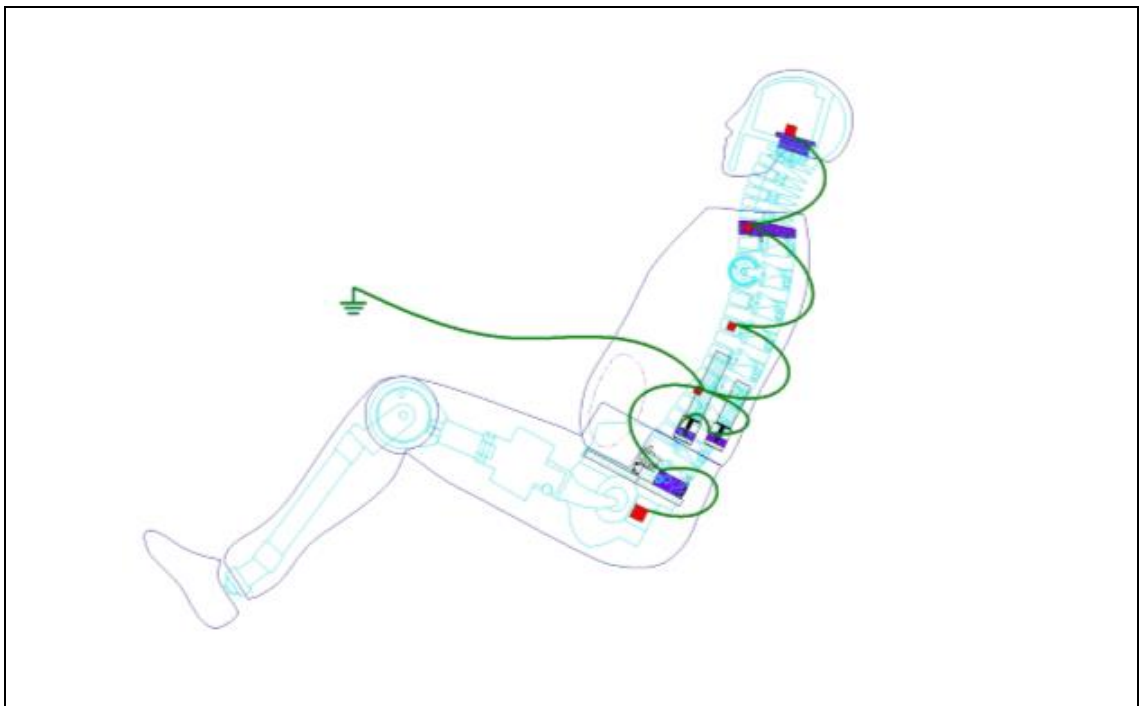

2.5.2. Head and Neck Cable Routing

Bundle together and tie-wrap the wiring for the head accelerometers and upper neck load cell. Install the skull cap, ensuring that the wiring bundle is in the recessed area of the skull so that the wiring is not damaged.

Route the cable bundle along the neck near C4. Continue to route cable to the T1 vertebrae, adding the T1 accelerometer and load cell cables to the bundle at the side of T1.

2.5.3. Thoracic Spine Cable Routing.

Figure 74 illustrates the correct cable routing for BioRID-II UN, which shall be used to prevent the instrumentation harness influencing spine movement. The method for installing the cabling is as follows:

Affix self-adhesive cable tie bases to the side plates of the spine. Add a cable tie to each base and tighten until the diameter of the tie-loop is 10mm. No cables are placed inside this tie-loop which are for providing a flexible link between the cables and the spine.

Secure the cable bundle together and to the first set of cable ties with a second set of cable ties, with one tie in the second set linking to each tie from the first set. All the cables will go through the second set of cable ties and none through the first set.

Add any accelerometer (or any other instrumentation selected from the options in Table 1) cables to the bundle as necessary.

Figure 74

Thoracic Spine cable routing



2.5.4. Pelvis Cable Routing

Bundle the instrumentation cables together inside the instrumentation cavity in the back of the pelvis. Route the cable up the back on the top of the pelvis.

Combine all instrumentation cable bundles on the top of the pelvis and exit the entire bundle between the jacket and the top of the pelvis. Figure 75 shows the cable bundle exiting the dummy.

Figure 75
Cable Bundle Exit

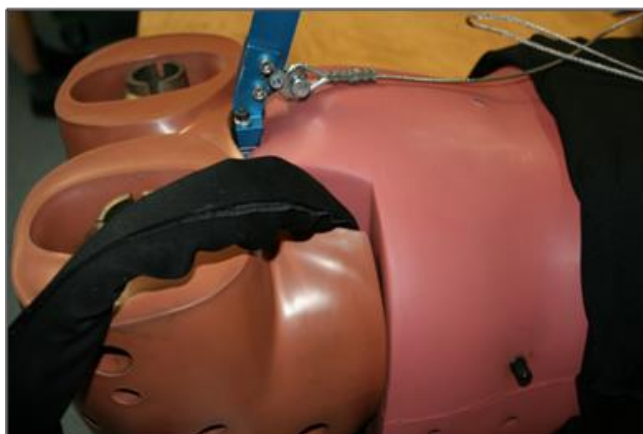

2.6. Accelerometer Handling

2.6.1. Care

Avoid dropping the accelerometer or striking the unit against hard surfaces and keep the unit in its protective sleeve until it is installed.

2.6.2. Preliminary Checks

Before installing accelerometers in the dummy, the accelerometers shall be checked in accordance with the accelerometer manufacturer's instructions to ensure correct operation and conformity to specified tolerances.

2.6.3. Installation Procedure

The mounting surface shall be clean and free of burrs, with a surface roughness of not more than 0.813 $\mu\text{m rms}$.

Remove the accelerometer from the protective sleeve. Handling it by the case, not the cable, place the unit on the mounting surface and align the mounting holes. When mounting the accelerometer, use only the materials and parts which are supplied with the accelerometer and use the mounting torque recommended by the accelerometer manufacturer. If applicable, use the supplied mounting washers and screws or mounting stud. Do not over torque the screws or use snap type torque wrenches (which can result in shocks that damage the accelerometer). Do not cement the unit to the mounting structure.

Where practical, tie down the cable within 40 to 60 mm of the accelerometer to prevent strain upon the join between the cable and accelerometer.

2.6.4. Recalibration

Sensitivity and Zero Measurand Output calibrations shall be performed at intervals of not more than 12 months to ensure conformity with manufacturer tolerances.

If the unit has been used beyond its rated specifications, a shorter calibration interval is recommended. Zero measurand output is defined as the output of the accelerometer when the accelerometer is stationary with its sensitive axis perpendicular to the gravitational field.

2.6.5. Cleaning

Dirty units may be wiped clean using a damp cloth and a solvent such as acetone. Do not soak or immerse the unit in any solvent or water. Do not use any sharp tools to remove dirt or contaminants. If tools such as pliers are needed to handle the accelerometer, cover the jaws to prevent metal to metal contact.

3. Bumper Maintenance

3.1. Overview

The cervical region of the spine (vertebrae C1 through C7 plus T1) contains sixteen cube-shaped bumpers. The eight front bumpers are black in colour and 10mm in height. The eight rear bumpers are split into 2 regions; the uppermost three are the same black, 10mm height bumpers as used in the front, and the bottom 5 are yellow in colour and 9mm in height.

3.2. Replacement Interval

The front cervical bumpers (C1-C7) and the front thoracic bumper (T1) shall be replaced no later than when they reach the age of 12months. The operational life of all other spinal bumpers is limited to 24 months. The period of validity of a dummy certification shall not exceed the date at which any bumper reaches its maximum operational age.

3.3. Replacement Procedure

Remove both lower cable adjusters and muscle substitute springs from the lower ends of the spring cables and tap or push the occipital condyle pin out of the spine (Figure 76).

Pull the spring cables up out of the upper cable adjusters as far as possible and turn the occipital condyle plate up and over (Figure 77). It will not swing in the other direction as the damper cable does not allow enough travel. Slide out the pins from C1 down to C7; these are easily removed and reinstalled by tapping gently or pushing with a punch.

Use a sharp pick to dislodge the bumper from each vertebra, from C1 down to C7, and to remove any glue or bumper residue (Figures 78 and 79).

Figure 76
Push out the occipital condyle pin

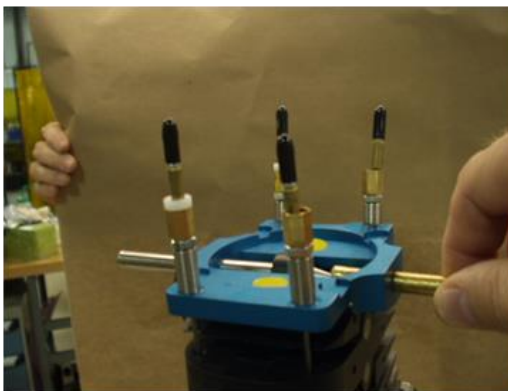

Figure 77
Remove pin and separate vertebra

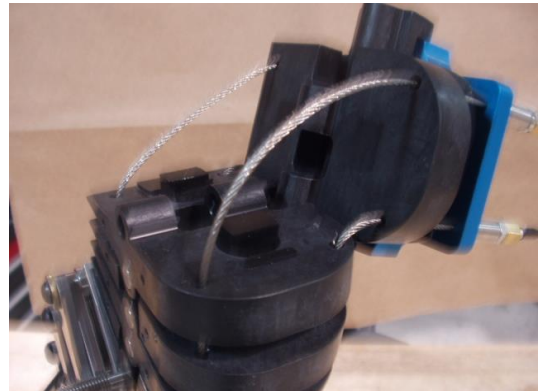

Figure 78
Using a pick to remove the C1-C7
bumpers

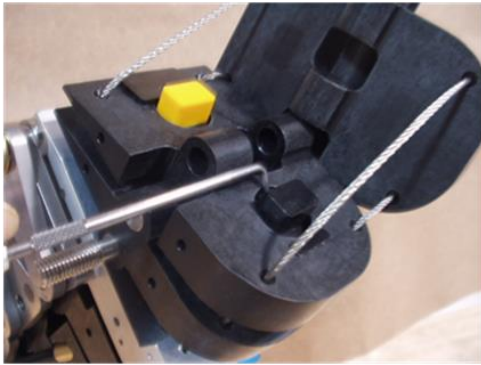

Figure 79
Clean the surface



To ensure the correct positioning of the cervical bumpers (C1 to C7) in the vertebrae bumper cavity, an installation tool shall be used (Figure 80). There are three separate tools; one for use at C1 (App.9/Dwg.021), one for use at C2, C4 & C6 (App.9/Dwg.022), and one for use at C3, C5 & C7 (App.9/Dwg.023). It is not necessary to use the tool at T1.

Place the bumper into place in the alignment tool and position the barrel of the tool between the two barrels on the vertebrae. Fix the tool in place by inserting an 8mm pin through the three barrels.

Figure 80
Cervical Bumper Installation Tools.
A, for C2, C4 and C6; B, for C3, C5 and C7



Place one drop of cyanoacrylate adhesive in the centre of the bore in the vertebrae. Close the tool to position the bumper into the vertebrae cavity and apply an even pressure to achieve a slight but visible compression of the bumper (Figure 81). Maintain the pressure for 10 seconds to allow the bumper to bond.

Figure 81

Inserting the Bumper in the Vertebra

Remove the two M2.5 SHCS that retain the T1 pin at the C7-T1 joint (Figure 82). Slide the T1 pin out of the vertebrae joint (Figure 83) and set it aside along with the two M2.5-0.45 x 8 SHCS for re-installation later.



Figure 82

Remove T1 Retaining Screws (1) using a wrench (2)

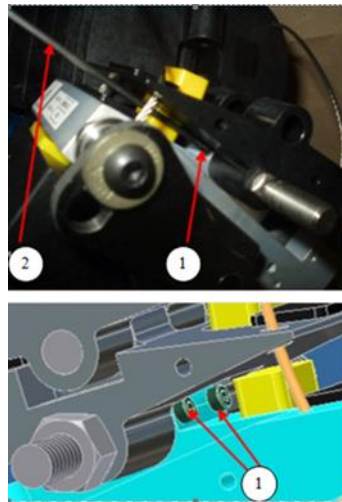

Figure 83

Remove the T1 pin



Use a pick to dislodge the front bumper in the T1 load cell vertebra (Figure 84) and to remove any remaining glue or bumper residue (as in Figure 79). Place one drop of cyanoacrylate adhesive in centre of the rectangular cavity in the T1 vertebrae. While the adhesive is still wet, place the new bumper in the cavity and press downward upon it with one finger for 10 seconds to bond. It will be positively located as the cavity is approximately the same shape as the bumper.

Figure 84
Using a pick to remove the T1 bumper



Re-install the T1 pin through the C7-T1 joint, taking care to avoid damaging the C7 vertebra or the T1 load cell joint with the threads on the T1 pin. Align the edge of the flat on the pin to the edge of the vertebra, as illustrated in Figure 85, and orient the face of the flat to be parallel with the back-end face of T1 load cell. This must be done to line up the threaded holes for the M2.5 SHCS. The face of the flat on the pin is precisely perpendicular to the threaded holes for two M2.5-0.45 x 8 SHCS

Figure 85
Alignment of the vertebrae edge and T1 pin
(1) Flat face on the pin
(2) Edge of the vertebrae
(3) End of face of T1 load cell

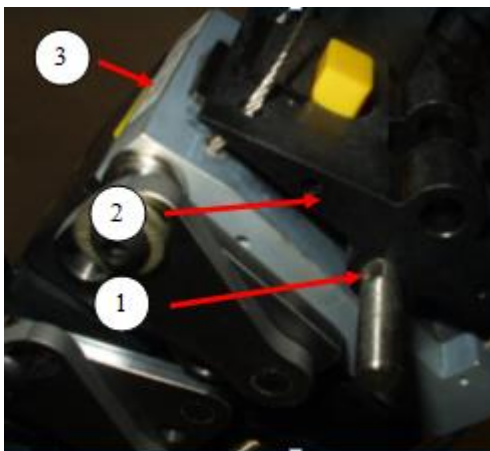

Re-install both M2.5-0.45 x 8 SHCS; a torque of 1.7 Nm is advised.

Re-install all pins from C1 to C7 by tapping lightly or pushing with a punch. The ends of the pins will be flush with the vertebrae when finished. Re-install the muscle substitute springs and lower spring cable adjusters onto both spring cables.

4. Storage and Handling
- 4.1. Transport Chair

A chair should be used for storage and transport of the dummy. The chair should support the spine to rest in a position where minimal loads are placed upon the bumpers. It should be able to spread the load on the jacket and pelvis to avoid damage occurring over time due to compression 4.2.

4.2. Lifting Procedure

To lift the dummy, the pelvis angle indicator attachment is used as an attachment point for the lift cable. An upper lift bracket is mounted at T-1 with a M8 wing nut on each side (Figure 86).

After the dummy is moved and positioned for testing, remove the upper bracket. If the pelvis position indicator attachment interferes with the seatbelt it needs to be removed and replaced with the two M6-1.0 x 25 mm SHCS.

Figure 86
Lifting Cable and Bracket

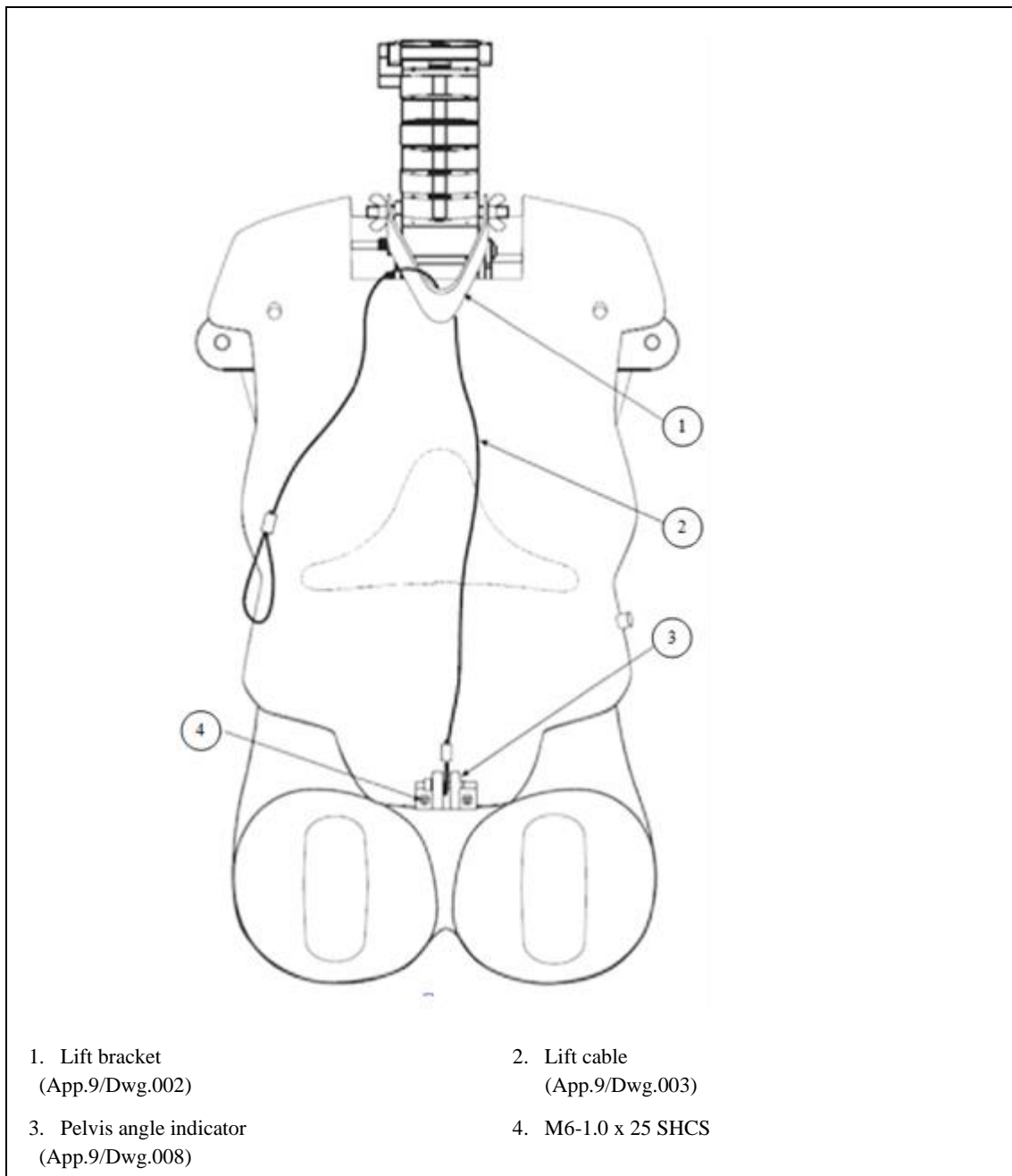

Annex 2

Engineering Drawings and Parts List

1. Drawings
 - 1.1. Introduction

The 2D engineering drawings contained within this Annex represent the essential dimensions of the assemblies and individual component parts of the BioRID-II UN dummy. Reference is made to generic manufacturing processes only.
 - 1.2. Drawing Descriptors

The drawings are listed by discrete body section in individual Appendices for ease of reference. The individual drawings are listed in an Index Table at the front of each Appendix. Each drawing has a UN ECE document reference that follows the standard UN ECE convention. The full document number is extended by a drawing descriptor – "Dwg." – followed by a sequential Arabic number, e.g. TRANS/WP.29/78/Add.1/App.1/ Dwg. 001, TRANS/WP.29/78/Add.1/App.1/ Dwg. 002.

For each separate Appendix to this Annex the first drawing is numbered "1". i.e. TRANS/WP.29/78/Add.1/App.2/ Dwg. 001, TRANS/WP.29/78/Add.1/App.3/ Dwg. 001. etc.
 - 1.3. Revisions

In accordance with standard engineering practice, the drawings in this Annex have their status identified by a "Revision Level". This is displayed as a capital Roman letter on the drawing and is referenced as " Dwg. Rev." in column 2. to the Index Table.

Product and manufacturing advances can result in changes to, for example, dimensional tolerances or manufacturing procedures. This may result in improvements to the precision of the dummy's response (accuracy, repeatability or reproducibility). In such cases the use of components engineered to a later drawing level than listed in the accompanying tables is accepted.

More significant changes, for example, changes to a material, or the mass distribution about the dummy, may be subject to review before being adopted for regulatory use. These changes require a revised drawing to be registered.

Should a drawing be subject to change, the original drawing is retained in this register and the new drawing number inserted in the table immediately after the original. Identification of this new drawing also follows UN ECE convention, having the same UN ECE number as the original with the addition of the appropriate revision nomenclature, e.g. TRANS/WP.29/78/Add.1/App.1/ Dwg. 001/Rev.1
2. Parts

Parts that are of commercial supply, or adequately defined by description, e.g. "Pin, Dowel 1/4" X 1/4\"", are listed separately. These parts do not have a UN ECE reference number.
3. Part Numbers

The components that comprise the dummy, whether specified by drawing or by part, are identified in the market by established part numbers. These numbers are also listed in the tables of the Appendices to this Annex. These unique part numbers are not proprietary and are available for use by any commercial company.

4. List of Appendices
 - Appendix 1. Assembly Drawings
 - Appendix 2. Head
 - Appendix 3. Cervical Spine
 - Appendix 4. Thoracic and Lumbar Spine
 - Appendix 5. Torso and Pelvis
 - Appendix 6. Muscle Substitute
 - Appendix 7. Limbs
 - Appendix 8. Tools

Drawing Appendices

Appendix 1

Assembly Drawings

Table 1
Drawing Index

<i>TRANS/WP.29/78/ Add.1/ App.1/...</i>	<i>Dwg. Rev.</i>	<i>Description</i>	<i>Common with Addenda</i>
Dwg.001	B	Leg Assembly, Left	App.8/Dwg.001
Dwg.002	B	Leg Assembly, Right	App.8/Dwg.002
Dwg.003	K	Complete Assembly	
Dwg.004	D	Head and Upper Torso Assembly	
Dwg.005	T	Spine Assembly	
Dwg.006	A	Neck Assembly	
Dwg.007	C	Lower Torso Assembly	

Appendix 2

Head

Table 1
Drawing Index

<i>TRANS/WP.29/78/ Add.1/ App.2/...</i>	<i>Dwg. Rev.</i>	<i>Description</i>	<i>Common with Addenda</i>
Dwg.001	F	Ballast, Skull	
Dwg.002	H	Upper Neck Structural Replacement	
Dwg.003	Y	Occipital Condyle Interface Plate	
Dwg.004	E	Head Assembly	
Dwg.005	L	Skull	
Dwg.006	D	Assembly, Occipital Condyle Plate	
Dwg.007	J	Skull, Cap	
Dwg.008	G	Accelerometer Mount	
Dwg.009	C	Head, Skin	
Dwg.010	E	Skull, Cap Skin	
Dwg.011	B	Skull Cap Assembly with Conductive Circuit	
Dwg.012	C	Skull Cap for Conductive Circuit	

Table 2
Parts

<i>Part Number</i>	<i>Description</i>	<i>QTY Per Assembly</i>	<i>QTY Per Dummy</i>
9000005	¼-20 x 5/8 (UNC) SHCS	2	2
9000126	¼-28 x 5/8 (UNF) SHCS	4	4
9000824	#8-32 x ½ (UNC) FHCS	3	3

Appendix 3

Cervical Spine

Table 1
Drawing Index

<i>TRANS/WP.29/78/ Add.1/ App.3/...</i>	<i>Dwg. Rev.</i>	<i>Description</i>	<i>Common with Addenda</i>
Dwg.001	F	Split Bushing - Front	App.4/Dwg.006
Dwg.002	F	Split Bushing - Rear	App.4/Dwg.007
Dwg.003	D	T1 Load Cell Assembly	
Dwg.004	Y	Vertebra, Cervical - C1	
Dwg.005	T	Vertebra, Cervical - C3, C5	
Dwg.006	T	Vertebra, Cervical - C4	
Dwg.007	T	Vertebra, Cervical - C2, C6	
Dwg.008	M	Vertebra, Cervical - C7	
Dwg.009	F	Pin, Neck C1-C2	
Dwg.010	H	Pin, Neck-Occipital C1	
Dwg.011	F	Pin, Neck C2-C7	
Dwg.012	G	Pin, Neck W/Flats C7, T1	
Dwg.013	L	Bumper, Cervical, Front and Rear	
Dwg.014	G	Rear Cervical Stop	
Dwg.015	F	Assembly, Cervical Vertebra-C1	
Dwg.016	K	Assembly, Cervical Vertebra-C2	
Dwg.017	M	Assembly, Vertebra - C3	
Dwg.018	E	Stop, Cervical - Front	
Dwg.019	H	Assembly, Cervical Vertebra - C7	
Dwg.020	K	Rear Cervical Bumper C4, C5, C6, C7	
Dwg.021	D	Assembly, Cervical Vertebra - C3	
Dwg.022	D	Assembly, Cervical Vertebra - C6	
Dwg.023	H	Bumper, Occipital	
Dwg.024	E	Assembly, Cervical Vertebra - C4	
Dwg.025	C	Washer, Damper	
Dwg.026	E	Structural Replacement, T1 Load cell	

Table 2
Parts

<i>Part Number</i>	<i>Description</i>	<i>QTY Per Assembly</i>	<i>QTY Per Dummy</i>
9010112	M4-0.7 x 6 SSFP -nylon tipped	2	2
9002030	Nut, Hex M8	2	2
9005132	O Ring	2	2
9010113	M2.5-0.45 x 8 SHCS	2	2

Appendix 4

Thoracic and Lumbar Spine

Table 1
Drawing Index

<i>TRANS/WP.29/78/ Add.1/ App.4/ ...</i>	<i>Dwg. Rev.</i>	<i>Description</i>	<i>Common with Addenda</i>
Dwg.001	D	Spacer for C7, T1 and T2 Assembly	
Dwg.002	C	Adaptor, S1 Load Cell to L5	
Dwg.003	C	Pelvis/Spine Interface Plate	
Dwg.004	B	S1 Load Cell Structural Replacement	
Dwg.005	B	S1 LC Load Cell Assembly, Structural Replacement	
Dwg.006	-	<i>Split Bushing - Front</i>	Refer to App.3/Dwg.001
Dwg.007	-	<i>Split Bushing - Rear</i>	Refer to App.3/Dwg.002
Dwg.008	B	T1 Load Cell	
Dwg.009	E	Structural Replacement, Load Cell Assembly	
Dwg.010	M	Vertebra, Thoracic - T2	
Dwg.011	C	Washer, Thoracic - Torsion, Modified	
Dwg.012	G	Washer, Torsion Adjustment	
Dwg.013	G	Pin, Torsion	
Dwg.014	G	Washer, Thoracic - Torsion	
Dwg.015	G	Washer, Lumbar - Torsion	
Dwg.016	R	Vertebra, Thoracic - T3	
Dwg.017	L	Vertebra, Thoracic - T4	
Dwg.018	K	Vertebra, Thoracic - T5	
Dwg.019	K	Vertebra, Thoracic - T6, T7, T9 - T12	
Dwg.020	K	Vertebra, Thoracic - T8	
Dwg.021	E	Washer, Torsion - T1 Load Cell	
Dwg.022	F	Torsion Washer - T4	
Dwg.023	B	Stop, Thoracic - Rear	
Dwg.024	B	Bumper, Thoracic - Rear	

<i>TRANS/WP.29/78/ Add.1/ App.4/ ...</i>	<i>Dwg. Rev.</i>	<i>Description</i>	<i>Common with Addenda</i>
Dwg.025	J	Bumper, Thoracic - Rear	
Dwg.026	K	Bumper, Thoracic - Front	
Dwg.027	H	Assembly, Thoracic Vertebra - T3	
Dwg.028	H	Assembly, Thoracic Vertebra - T4	
Dwg.029	H	Assembly, Thoracic Vertebra - T5	
Dwg.030	J	Assembly, Thoracic Vertebra - T6, T10, T12	
Dwg.031	H	Assembly, Thoracic Vertebra - T7, T9, T11	
Dwg.032	G	Assembly, Thoracic Vertebra - T2	
Dwg.033	E	Assembly, Thoracic Vertebra - T8	
Dwg.034	K	Vertebra, Lumbar - L1	
Dwg.035	K	Vertebra, Lumbar - L2-L5	
Dwg.036	J	Bumper, Lumbar - Rear	
Dwg.037	H	Bumper, Lumbar - Front	
Dwg.038	G	Assembly, Lumbar Vertebra - L1	
Dwg.039	G	Assembly, Lumbar Vertebra - L3, L5	
Dwg.040	F	Assembly, Lumbar Vertebra - L2, L4	
Dwg.041	B	S1 Interface Plate Assembly	
Dwg.042	B	S1 Vertebra	
Dwg.043	D	Pelvis Spine Interface Plate	
Dwg.044	B	S1 Vertebra with Load Cell	

Table 2
Parts

<i>Part Number</i>	<i>Description</i>	<i>QTY Per Assembly</i>	<i>QTY Per Dummy</i>
9005108	M8-1.25 x 25 SHCS	1	1
9004036	M6-1.0 x 25 FHCS	4	4
4000076	5/16 x 3/4 Washer	2	2
9005125	M8-1.25 x 12 SHCS	16	16
9010000	M5 Hex Nut	2	2
9001447	M6-1.0 x 25 SHCS	1	1
9000776	9/32 x 5/8 Washer	1	1
9009285	5/16 x 3/4 Washer	16	16
9010443	Tension Washer	1	1
9010454	M6-1.0 x 12 Low Head SHCS	6	6
6588	Adaptor S1 LC	1	1
9010051	M4-0.7 x 10 SHCS	6	6
9005170	M2.5-0.45 x 12 SHCS	10	10
9001445	M6-1.0 x 12 FHCS	2	2

Appendix 5

Torso and Pelvis

Table 1
Drawing Index

<i>TRANS/WP.29/78/ Add.1/ App.5/...</i>	<i>Dwg. Rev.</i>	<i>Description</i>	<i>Common with Addenda</i>
Dwg.001	D	Spine-Torso Interface - Left	
Dwg.002	D	Pelvis Interface Abdomen Attachment	
Dwg.003	E	Reinforcement, Arm Attachment	
Dwg.004	C	Spine-Torso Interface - Right	
Dwg.005	J	Attachment, Arm	
Dwg.006	J	Arm Attachment Assembly - Right	
Dwg.007	C	Shoulder Yoke	
Dwg.008	H	Spine, Torso Interface Pin Assembly	
Dwg.009	H	Spine, Torso Interface Pin Assembly	
Dwg.010	H	Spine, Torso Interface Pin Assembly	
Dwg.011	H	Spine, Torso Interface Pin	
Dwg.012	H	Spine, Torso Interface Pin Assembly	
Dwg.013	H	Spine, Torso Interface Pin Assembly	
Dwg.014	H	Spine, Torso Interface Pin Assembly	
Dwg.015	E	Bushing, Shoulder	
Dwg.016	H	Block, Bushing	
Dwg.017	C	Plate, Back (Thick)	
Dwg.018	C	Plate, Back (Thin)	
Dwg.019	C	Plate, Back (Spine)	
Dwg.020	J	Arm Attachment Assembly - Left	
Dwg.021	H	Torso Jacket Assembly	
Dwg.022	J	Retainer, Spring Tube	App.6/Dwg.022
Dwg.023	F	Pelvis Interface, Abdomen Attachment	
Dwg.024	K	Bone, Pelvis	
Dwg.025	H	Pelvis, Moulded	
Dwg.026	D	Gasket, Anti Slap	
Dwg.027	E	Pelvis Lift Bracket	
Dwg.028	B	H-Point Attachment, Left	
Dwg.029	B	H-Point Attachment, Right	

Table 2
Parts

<i>Part Number</i>	<i>Description</i>	<i>QTY Per Assembly</i>	<i>QTY Per Dummy</i>
9004036	M6-1.0 x 25 FHCS	2	2

Appendix 6

Muscle Substitute

Table 1
Drawing Index

<i>TRANS/WP.29/78/ Add.1/ App.6/...</i>	<i>Dwg. Rev.</i>	<i>Description</i>	<i>Common with Addenda</i>
Dwg.001	W	Body, Rotary Damper	
Dwg.002	E	Wheel, Cable Guide	
Dwg.003	F	Damper Paddle Clamp Bracket	
Dwg.004	L	Cover, Damper	
Dwg.005	F	Adjustment, Cable - Attachment	
Dwg.006	F	Spring Cable (Muscle Substitute Assy.)	
Dwg.007	E	Calibration Screw	
Dwg.008	D	Damper Paddle Wheel	
Dwg.009	R	Assembly, Rotary Damper	
Dwg.010	B	BioRID Calibration Screw O-Ring Assy.	
Dwg.011	A	Damper & Mounting Plate Assy.	
Dwg.012	E	Spring, Anterior Muscle Substitute	
Dwg.013	F	Spring, Posterior Muscle Substitute	
Dwg.014	E	Posterior Spring Tube (Muscle Substitute Assy.).	
Dwg.015	E	Anterior Spring Tube (Muscle Substitute Assy.).	
Dwg.016	F	Piston, Muscle Substitute Assy.	
Dwg.017	D	Cable Adjuster	
Dwg.018	J	Damper Cable	
Dwg.019	C	Cable - Sleeve	
Dwg.020	E	Cable Terminal	
Dwg.021	D	Cable Cap, Vinyl.	
Dwg.022	-	Retainer, Spring Tube	Refer to App.5/Dwg.022
Dwg.023	D	Cable Post, Lead-In Sleeve.	

Table 2
Parts

<i>Part Number</i>	<i>Description</i>	<i>QTY Per Assembly</i>	<i>QTY Per Dummy</i>
9009091	Cable Adjuster	4	4
9010293	Cable Cap	4	4

Appendix 7

Arms and Hands

Table 1
Drawing Index

<i>TRANS/WP.29/78/ Add.1/ App.7/...</i>	<i>Dwg. Rev.</i>	<i>Description</i>	<i>Common with Addenda</i>
Dwg.001	B	Left Arm Assembly	
Dwg.002	B	Right Arm Assembly	
Dwg.003	C	Upper Arm - Moulded Assembly	
Dwg.004	C	Upper Arm - Lower Part	
Dwg.005	C	Lower Arm	
Dwg.006	D	Stop, Lower Arm	
Dwg.007	G	Bushing, Upper Arm and Elbow Pivot	
Dwg.008	D	Washer, Upper Arm and Elbow Pivot	
Dwg.009	E	Elbow Pivot Nut	
Dwg.010	D	Wrist Rotation	
Dwg.011	B	Hand, Left	
Dwg.012	C	Hand, Right	
Dwg.013	G	Screw, Wrist Pivot	
Dwg.014	D	Washer, Shoulder Joint Spring	
Dwg.015	F	Elbow Yoke	
Dwg.016	B	Structural Assembly Upper Arm	
Dwg.017	K	Shaft, Upper Arm Pivot	
Dwg.018	E	Tube-Upper Arm, Upper Part	
Dwg.019	D	Clamp-Upper Arm Rotation	
Dwg.020	E	Tube, Upper Arm - Lower Part	
Dwg.021	E	Shaft, Upper Arm - Rotation	
Dwg.022	D	Structural Assembly, Lower Arm - Upper Part	
Dwg.023	D	Tube - Lower Arm	
Dwg.024	E	Clamp - Wrist Rotation	
Dwg.025	D	Lug - Wrist, Upper	
Dwg.026	D	Lug - Wrist, Lower	
Dwg.027	D	Shaft - Wrist Rotation	

<i>TRANS/WP.29/78/ Add.1/ App.7/...</i>	<i>Dwg. Rev.</i>	<i>Description</i>	<i>Common with Addenda</i>
Dwg.028	D	Structural Assembly - Hand	
Dwg.029	D	Hand Hub	
Dwg.030	F	Hand Plate - Inner	
Dwg.031	D	Hand Plate - Outer	

Table 2
Parts

<i>Part Number</i>	<i>Description</i>	<i>QTY Per Assembly</i>	<i>QTY Per Dummy</i>
9010283	M10-1.5 x 45 SHCS	3	6
9006003	3/8-16 x 1 1/2 SHSS (UNC)	1	2
9000055	1/2x 1 1/4 SHSS (3/8- 16 UNC)	1	2
9001260	1.06 x .53 Washer	1	2
9000074	3/8x 1 SHSS (5/16-18 UNC)	1	2
9006003	3/8 x 1 1/2 SHSS (5/16- 18 UNC)	1	2
9000055	1/2x 1 1/4 SHSS (3/8- 16 UNC)	1	2
9001260	1.06 x .53 Washer	1	2
9000074	3/8x 1 SHSS (5/16-18 UNC)	1	2

Appendix 8

Legs and Feet

Table 1
Drawing Index

<i>TRANS/WP.29/78/ Add.1/ App.8/...</i>	<i>Dwg. Rev.</i>	<i>Description</i>	<i>Common with Addenda</i>
Dwg.001	-	Leg Assembly, Left	Refer to App.1/Dwg.001
Dwg.002	-	Leg Assembly, Right	Refer to App.1/Dwg.001
Dwg.003	D	Knee Flesh, Left	
Dwg.004	D	Knee Flesh, Right	
Dwg.005	E	Knee Insert	
Dwg.006	B	Upper Leg, Moulded Left	
Dwg.007	B	Upper Leg, Moulded Right	
Dwg.008	G	Structural Assy. Upper Leg, Left	
Dwg.009	G	Structural Assy. Upper Leg, Right	
Dwg.010	B	Lower Leg Flesh, Left	
Dwg.011	B	Lower Leg Flesh, Right	
Dwg.012	H	Load Cell Simulator	
Dwg.013	B	Foot Assembly, Left	
Dwg.014	B	Foot Assembly, Right	
Dwg.015	K	Heel Pad	
Dwg.016	C	Ankle Bumper	
Dwg.017	E	Knee Cap	
Dwg.018	E	Inboard Pedestrian Knee Slider Replacement	
Dwg.019	E	Outboard Pedestrian Knee Slider Replacement	
Dwg.020	D	Shoulder Bolt, Knee Slider	
Dwg.021	G	Washer, Knee Slider	
Dwg.022	D	Compression Washer, Knee Slider	
Dwg.023	G	Rotation Stop Cover, Knee Slider	
Dwg.024	C	Rotation Stop Arm, Knee Slider	
Dwg.025	M	Ankle Shaft	

<i>TRANS/WP.29/78/ Add.1/ App.8/...</i>	<i>Dwg. Rev.</i>	<i>Description</i>	<i>Common with Addenda</i>
Dwg.026	J	Stop Pin Retainer	
Dwg.027	D	Foot Attachment Bolt	
Dwg.028	E	Ankle to Leg Attachment Bolt	
Dwg.029	D	Ankle Friction Pad	
Dwg.030	B	Ankle Assembly	
Dwg.031	K	Knee Weldment - Structural Replacement	
Dwg.032	M	Ankle - Upper Shell	
Dwg.033	K	Lower Ankle Shell, Machined	
Dwg.034	C	Upper Leg Ballast Ring	
Dwg.035	D	Upper Leg Shaft	
Dwg.036	G	Upper Leg Clamp, Left	
Dwg.037	G	Upper Leg Clamp, Right	
Dwg.038	G	Sole Plate	
Dwg.039	F	Plate – Ankle Support	
Dwg.040	H	Plate, Instep	
Dwg.041	H	Support, Ankle - Left	
Dwg.042	J	Support, Ankle - Right	
Dwg.043	D	Ballast Weight	
Dwg.044	M	Weldment, Foot, Left	
Dwg.045	M	Weldment, 45 Degree, Right	
Dwg.046	B	Standoff, Outstep Side	
Dwg.047	B	Standoff, Instep Side	
Dwg.048	C	Threaded Insert - Modified	
Dwg.049	-	Reserved for future application	
Dwg.050	K	Upper Tibia, Structural Replacement	
Dwg.051	C	Leg Tube, Structural Replacement	
Dwg.052	H	Knee Clevis Half	
Dwg.053	J	Lower Tibia, Structural Replacement	
Dwg.054	G	Knee Base with Wedge	

<i>TRANS/WP.29/78/ Add.1/ App.8/...</i>	<i>Dwg. Rev.</i>	<i>Description</i>	<i>Common with Addenda</i>
Dwg.055	H	Rubber Bumper Steel Plate	

Table 4
Parts

<i>Part Number</i>	<i>Description</i>	<i>QTY Per Assembly</i>	<i>QTY Per Dummy</i>
9000126	1/4-28 x 5/8 SHCS (UNF)	4	
9000072	3/16 x 1/2 Dowel Pin	1	
9000073	5/16-18 x 3/8 SSCP (UNC)	1	
9006010	#10-32 x 1/4 SSCP (UNF)	2	
9000076	#8-32 x 1/2 BHCS (UNC)	2	
9000449	3/8-16 x 1 3/4 SHCS (UNC)	1	
9000066	3/8-16 x 2 SHCS (UNC)	1	
9005079	8-32 x 1/2 SHCS	2	
9004028	1/4-28 x 3/8 FHCS (UNF)	8	

Appendix 9

Tools

Table 1
Drawing Index

<i>TRANS/WP.29/78/ Add.1/ App.9/...</i>	<i>Dwg. Rev.</i>	<i>Description</i>	<i>Common with Addenda</i>
Dwg.001	E	Alignment Tool	
Dwg.002	E	Lift Bracket	
Dwg.003	F	Lift Cable	
Dwg.004	E	Head Levelling Tool	
Dwg.005	B	Head Locking Device	
Dwg.006	C	Locking Arm	
Dwg.007	C	Bolt Bracket	
Dwg.008	A	Pelvis Angle Indicator Assembly	
Dwg.009	F	Arm, Pelvis Angle Indicator	
Dwg.010	F	Bracket, Pelvis Angle Indicator	
Dwg.011	C	Shorts Pattern and Specification	
Dwg.012	C	Shirt Pattern and Specification	
Dwg.013	B	T1 Angle Indicator Assembly	
Dwg.014	A	T1 Indicator Mounting Bracket	
Dwg.015	A	T1 Angle Indicator Bar	
Dwg.016	C	H-Point Locator	
Dwg.017	E	Spine Vertebrae Spacing Fixture	
Dwg.018	F	Vertebrae Spacer Upper Cam Arm	
Dwg.019	H	Vertebrae Spacer Lower Cam Arm	
Dwg.020	J	Vertebrae Spacer	
Dwg.021	B	Bumper installation tool, cervical vertebra C1	
Dwg.022	A	Bumper installation tool, cervical vertebra C2, C4, C6	
Dwg.023	A	Bumper installation tool, cervical vertebra C3, C5, C7	

Annex 3

Certification Procedures

1. Introduction

The BioRID-II UN Dummy Certification Test Procedures are to insure proper performance of, and consistent results between, dummies. The procedures include tests to verify dummy and dummy component performance. Procedures to validate the sled and track system response to defined inputs are set out in the Appendix 1 to this Annex.

The compliance tests are:

1.1. Jacket Validation Test

This test verifies the stiffness of the jacket material remains within the specified limits. The jacket used in the certification procedure shall be validated in accordance with paragraph 4.

1.2. Lower Torso Validation Test

This test verifies the material inside the pelvis remains within the specified limits. The lower torso is not used during the dummy certification test, but its validation is necessary before the whole dummy assembly can be certified. The procedures for validation of the lower torso are detailed in paragraph 5.

1.3. Dummy Certification Test

This test ensures the dummy's neck will provide reliable test results. The test also provides evidence the damper, neck bumpers, muscle substitute springs and cable, are working correctly as a system. The procedures for the certification tests of the dummy are detailed in paragraph 3.

1.4. In advance of the certification tests for the jacket, lower torso, and for the dummy it shall be ensured that:

- (a) the performance of the sled and track system has been validated (Appendix 1),
- (b) the dummy components have been checked to ensure that they comply with the BioRID-II UN dummy specification (Appendix 2, Part 1 - BioRID-II UN Design Checklist and Part 2 - Maintenance Checklist),
- (c) the front neck bumpers (C1 – C7) and the front thoracic bumper (T1) are less than 12-months old, and,
- (d) all other spinal bumpers are less than 24-months old.

1.5. The dummy certification certificate shall be valid for a period no greater than 12-months. In the case where the spinal bumpers will exceed the age specified above, the dummy compliance certificate shall only be valid until the first bumper age threshold is reached. Similarly, the validity of the dummy certificate shall not exceed the validity of the certification of the jacket or of the lower torso assembly.

If the dummy experiences a severe impact, a further dummy certification test shall be required.

2. Required Test Equipment and Specifications

2.1. Sled and Track System

The sled system shall comprise an acceleration sled assembly that is free to move on linear bearings along a machined and guided track. The sled shall be designed to allow the BioRID-II UN upper torso and head to be mounted to its forward structure, and with an impact face plate to the rear. It shall be possible separately to mount the BioRID-II UN jacket assembly and the lower torso to

the impact face to allow for their individual validation. An example of a suitable sled and track system is shown at Figure 1.

Figure 1

Example of a sled and track system with impactor and energy transfer device

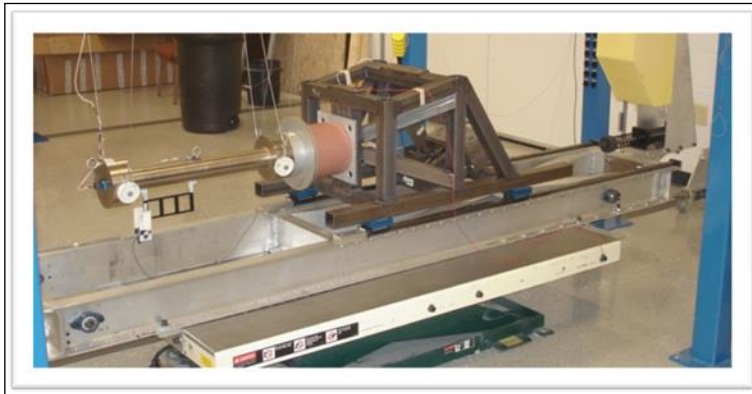

The critical dimensions to establish the relative position of the essential mounting points of the sled assembly, in respect to the impactor, are shown in Figure 2. The centre point of the impact face plate shall lie 138.5mm +/- 3.5mm above the centre point of the lower mounting hole on the top surface of the torso assembly attachment plate.

Figure 2

Essential dimensions for the sled assembly (mm)

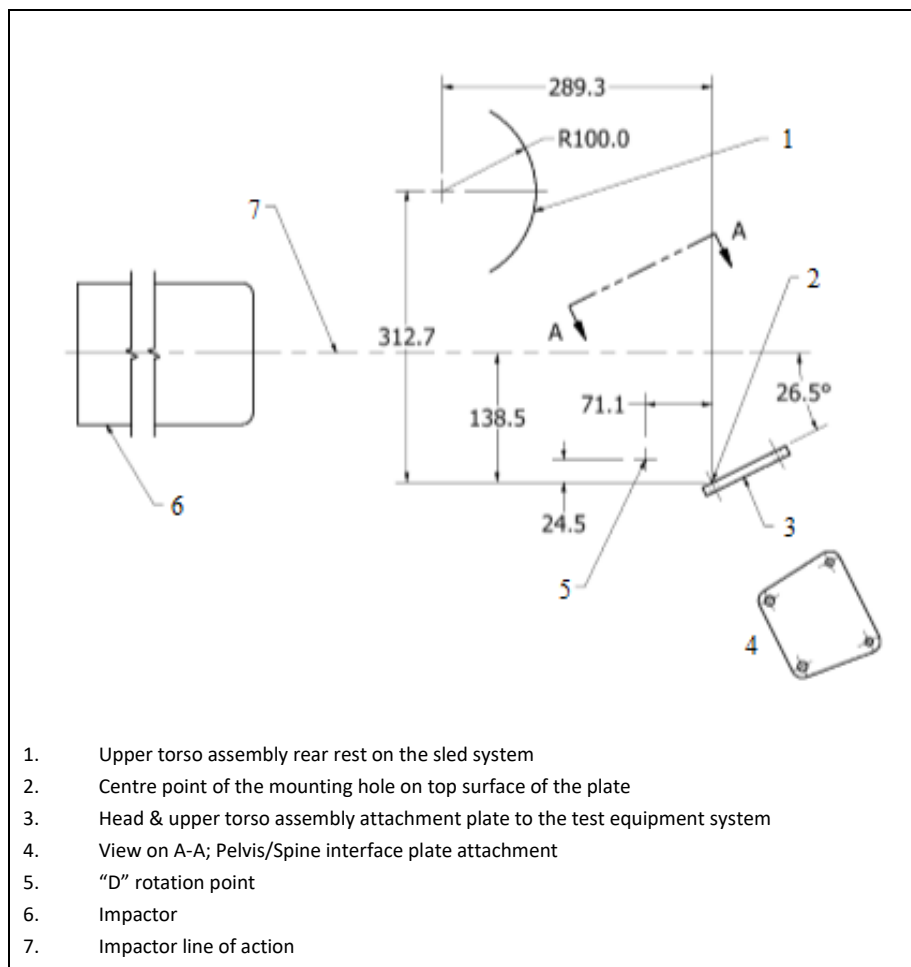

The mass of all the components that move with the system (excluding the energy transfer device and its mounting screws) shall be 44.25 kg +/- 0.05 kg.

The impact face plate shall provide for the attachment of an energy transfer device and, separately, for the attachment of the dummy jacket and the lower torso.

2.2. Impactors

Pendulum type impactors are described in this section; however, alternative arrangements may be used providing that they satisfy the essential performance criteria.

The suspension system for the impactor shall be designed to ensure that, under the dynamic conditions of use, the centreline of the impactor remains vertically within +/- 2mm of its at rest position.

2.2.1. Upper Torso Impactor

The upper torso impactor shall comprise two parts which shall be of rigid metallic construction and concentric about their longitudinal axis.

The primary part of the impactor shall be designed to allow it to be suspended such that, in an at -rest position, its longitudinal centreline is level in the horizontal plane.

The impactor shall have a mass of 33.55 kg +/- 0.1 kg. This mass includes the mass of the lower 1/3 of the suspension cables and their attachment fittings to the impactor.

A separate, detachable, impact face shall have a mass of 4.05 kg +/- 0.01 kg. The impacting face of the impactor shall be perpendicular and concentric with the longitudinal axis of the impactor, and have a flat, continuous, and non-deformable 254 +/- 0.25 mm diameter surface with a 1mm - 2 mm thick polytetrafluoroethylene (PTFE) covering, extending rearward a minimum of 12.7 mm.

2.2.2. Jacket/Lower Torso Impactor

The jacket / lower torso impactor shall be of rigid metallic construction and concentric about its longitudinal axis.

It shall have a mass of 13.97 +/- 0.02 kg which includes all attached hardware, including the mass of the lower 1/3 of the suspension cables and their attachment fittings to the impactor. The combined mass of the lower 1/3 of the impactor suspension cables and all hardware attached to the impactor must not exceed 5 per cent of the total impactor mass.

The impacting end of the test impactor is to be perpendicular and concentric with the longitudinal axis of the impactor, having a flat, continuous, and non-deformable 152.4 +/- 0.25 mm diameter impact face, extending rearward a minimum of 25 mm, with an edge radius of 7.6 mm - 12.7 mm.

2.3. Instrumentation

2.3.1. The data acquisition system used for the certification procedure shall conform to ISO 6487:2015 or SAE J211/1 201403.

2.3.2. The impactor acceleration data shall be collected and filtered using a Channel Class 180 phaseless filter.

2.3.3. The sled system acceleration data shall be collected and filtered using a Channel Class 60 phaseless filter.

- 2.3.4. The accelerometers for the sled system, the dummy impactor and the jacket / pelvis impactor shall, as a minimum, satisfy the following criteria:

Table 1
Accelerometer Criteria

<i>Range</i>	<i>+/- 2000g</i>
<i>Mounted resonance frequency</i>	<i>22,000 Hz MIN</i>
<i>Damping ratio</i>	<i>Undamped (0.005)</i>
<i>Transverse sensitivity</i>	<i>+/- 1% MAX</i>
<i>Non-linearity & hysteresis</i>	<i>+/- 2% MAX</i>

- 2.3.5. The Potentiometers used in BioRID-II UN shall comply with SAE J2570_201911 and their signal output must be compatible with, and recordable in a data channel according to, SAE J211/1_201403. They shall also, as a minimum, satisfy the following criteria:

Table 2.
Potentiometer Criteria

<i>Mechanical and electrical range</i>	<i>≥ +/- 50 degrees of rotation</i>
<i>Resolution:</i>	<i>virtually infinite</i>
<i>Shock</i>	<i>50 g</i>
<i>Non-linearity over +/- 50-degree range</i>	<i>+/- 0.25% of full scale</i>

2.3.6. Data Channel Filters

- (a) Impact Probe Accelerometer (Channel Class 180 phaseless filter)
- (b) Sled Accelerometer (Channel Class 60 phaseless filter)
- (c) T1 Accelerometer (Channel Class 60 phaseless filter)
- (d) Potentiometers (Channel Class 60 phaseless filter)
- (e) Upper Neck Moment My (Channel Class 600 phaseless filter)

All analogue data used during the data manipulations in section 6 shall be filtered using a CFC1000 forward filter.

2.4. Energy Transfer Device (ETD)

An impact block device, mounted to the impact face of the sled system. The ETD modulates the energy transferred from the impactor to the sled and influences the sled acceleration profile. The mass of the ETD (and its attachment bolts) shall be 2.90 kg +/- 0.01 kg.

2.5. Velocity Measurement

A velocity measurement instrument (e.g. light trap) that can be mounted to determine the average velocity of the impactor at a defined position in flight. The instrument shall have an accuracy of \leq +/- 0.75% of its reading.

3. BioRID-II UN Dummy Certification

The dummy certification testing establishes that, when conducting tests in accordance with UN Global Technical Regulations or UN Regulations, the dummy response is within specification.

The BioRID-II UN dummy shall be certified as suitable for use when testing for compliance with the performance values established in UN Global Technical Regulations, or UN Regulations, if the test conditions and the dummy response satisfy the following limits:

3.1. Test Conditions

- (a) The peak impactor force shall be not less than 8000 N and not more than 9700 N. The force shall be calculated by the product of the impactor mass and the impactor deceleration.
- (b) The peak sled acceleration shall be not less than 137 m/s² and not more than 170 m/s².
- (c) The first peak sled velocity shall be not less than 2.25 m/s and not more than 2.50 m/s in the time interval between 20 ms and 30 ms after initial contact.
- (d) The sled velocity shall be not less than 2.1 m/s at 135 ms to 2.0 m/s at 140 ms and not more than 2.5 m/s at 135 ms to 2.4 m/s at 140 ms. The timings shall be measured after initial contact.

3.2. Dummy Response

- (a) The maximum T1 X axis acceleration shall occur in the interval between 18.5 ms and 30.5 ms after initial contact and shall be between 183 m/s² and 267 m/s².
- (b) The maximum head rotation about the occipital condyle shall occur in the interval between 25 ms and 70 ms after initial contact and shall be not less than 10.1 degrees and not more than 15.1 degrees.
- (c) Each data point for the head rotation during the time interval between 125 ms and 135 ms after initial contact shall be between 2.0 degrees and -9.0 degrees.
- (d) The maximum neck link rotation (potentiometer B) shall occur in the interval between 18.5 ms and 28.5 ms after initial contact and shall be not less than 4.0 degrees and not more than 6.5 degrees.
- (e) The minimum value for the neck link rotation (potentiometer B) shall not be less than -36 degrees.
- (f) Each data point for the neck link rotation (potentiometer B) during the time interval between 98 ms and 108 ms shall be less than -30 degrees and for the time interval between 165 ms and 175 ms shall be less than -29 degrees.
- (g) The minimum T1 rotation (potentiometer C) shall not be less than -19.0 degrees.
- (h) Each data point for the T1 rotation (potentiometer C) during the time interval between 73 ms and 78 ms shall be less than -16.5 degrees.
- (i) The total head rotation is the sum of head rotation (potentiometer A) and neck link rotation (potentiometer B).
- (j) Each data point for the total head rotation shall not be less than -41.0 degrees during the time interval 100 ms and 190 ms.
- (k) Each data point for the total head rotation during the time interval between 100 ms and 110 ms, shall be less than -25.0 degrees and, during the time interval between 170 ms and 190 ms, shall be less than -25.0.
- (l) The total thoracic rotation is the sum of T1 rotation (potentiometer C) and lower spine rotation (potentiometer D).
- (m) The minimum total thoracic rotation shall not be less than -21.0 degrees.
- (n) Each data point for the total thoracic rotation during the time interval between 125 ms and 135 ms, shall be less than -10.0 degrees.

- (o) The maximum upper neck moment (M_y) shall occur in the interval between 20 ms and 35 ms after initial contact and shall be in the range 7.7 Nm and 17.8 Nm.
 - (p) The minimum upper neck moment (M_y) shall occur in the interval between 66 ms and 83 ms after initial contact and shall be in the range - 23.5 Nm and - 15.0 Nm.
- 3.3. Pre-Test preparation
- 3.3.1. Ensure that:
- 3.3.1.1. The spinal bumpers are within the serviceable age limits (paragraph 1.).
 - 3.3.1.2. The dummy assembly and its components have been verified as BioRID-II UN compliant (Appendix 2, Part 1) and serviceable (Appendix 2, Part 2).
 - 3.3.1.3. The jacket has been validated within the last year prior to performing this test. The validation procedure is defined in paragraph 4. below.
 - 3.3.1.4. The dummy has no damage, loose or missing screws, loose or missing bumpers, etc.
- 3.3.2. The arms and the lower torso assembly have been removed.
- 3.3.3. Attach the torso and head assembly to the dummy mounting plate on the sled. Remove the head and, using the machined sled track rail as a zero reference, verify the lateral angle of the occipital condyle plate is less than +/-0.5 degrees. Adjust dummy position if necessary.
- 3.3.4. Install the upper neck load cell (if not already in the dummy) and reattach the head with the long occipital condyle pin to attach potentiometer A. Attach potentiometer A and potentiometer B to the dummy between T1 and the occipital condyle pin (Figure 3). Attach potentiometer C to opposite side of the T1 pin (Figure 4). Tighten the nut against the potentiometer collets to keep them from rotating during the test.

Figure 3

Potentiometer A and B locations

Figure 4
Potentiometer C location.



3.3.5. Install an “X” axis accelerometer to the T1 load cell shown in Figure 5.

Figure 5
X-axis accelerometer attachment

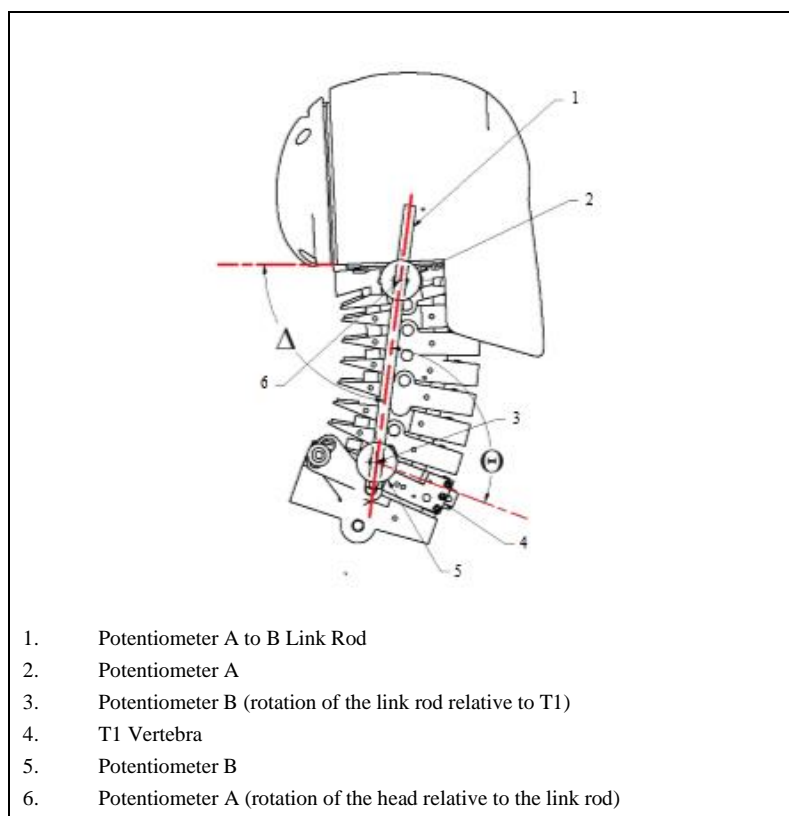
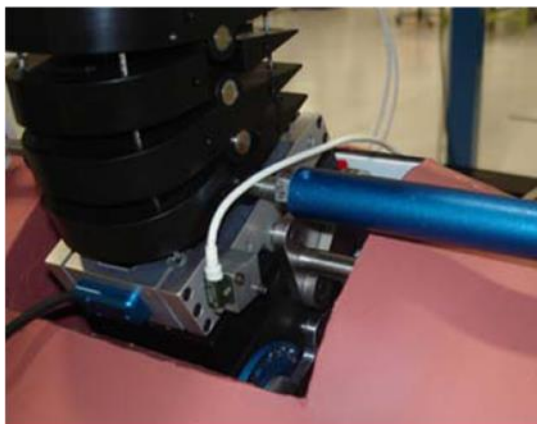

3.3.6. Level the fore and aft inclination of the head to less than +/- 0.5 degrees (Figure 6).

Figure 6
Head Setup Angle



3.3.7. Prepare the sled system and dummy impactor. The sled system shall be validated in accordance with Appendix 1.

3.3.7.1. Suspend the dummy impactor so that its longitudinal centreline is parallel +/- 0.5 degrees to the impactor’s line of action plane. Mount the impactor

accelerometer on the end of impactor opposite to the impact face and with its sensitive axis in line with its longitudinal centreline.

- 3.3.7.2. Position the sled system so that the linear guide rails are parallel to the longitudinal centreline of the impactor. Mount the sled accelerometer to the sled with its sensitive axis parallel to the longitudinal centreline of the impactor.
- 3.3.7.3. With the impactor hanging freely, ensure that its centreline is aligned to the alignment hole on the sled impact plate. In the example in **Error! Reference source not found.**7 a detachable alignment shaft is attached to the front of the impactor. The line of action centreline shall be 0mm +/- 2mm horizontally and vertically with the impactor centreline at the point of impact when mounted to the sled system.

Figure 7

Impact Probe Alignment



- 3.3.7.4. Attach the energy transfer device to sled impact plate. The side to side centreline plane of the energy transfer device shall be parallel +/- 0.5 degrees to the line of action plane of the impactor.
- 3.3.7.5. With the impactor hanging freely, slide the sled toward it until the energy transfer device is just touching the impactor face. Ensure the sled has at least 500 mm of unrestricted travel in the direction of flight of the impactor.
- 3.3.8. Soak all hardware in a controlled environment at any temperature between 20.6°C - 22.2°C and a relative humidity between 10 and 70 percent for not less than 4 hours prior to testing.
- 3.4. BioRID-II UN Certification Test Procedure
 - 3.4.1. The dummy impactor and impactor face assembly shall be released from a position to achieve a velocity as described in Appendix 1, paragraph 1.3.2.6. of between 4.7 m/s and 4.8 m/s. It shall be ensured that, at the instant of contact with the energy transfer device, the longitudinal plane of the impactor is +/- 0.5 degrees relative to the vertical and horizontal planes.
 - 3.4.2. Wait at least 30 minutes between successive impacts on the ETD or dummy.
 - 3.4.3. Time zero (t_0) (or the time of initial contact) of the test is defined as the time when the CFC1000 forward filtered impactor acceleration reaches 9.81 m/s² after impact with either the energy transfer device, the jacket or the lower torso assembly.
- 4. Jacket Certification Procedures

The jacket certification test shall be completed annually.

4.1. Jacket Response

The test shall be valid if, when the anterior surface of the jacket is impacted in accordance with paragraph 4.4.1.,

- (a) The peak impactor force is not less than 1110N and not more than 1360N. The force shall be calculated by the product of the impactor mass and the impactor deceleration.
- (b) The peak sled system velocity is not less than 0.378 m/s and not more than 0.422 m/s.

4.2. Compression Monitoring

Jacket compression, calculated from the difference between the double integrated sled and impactor accelerometers, shall be recorded in the compliance test report (paragraph 7). These data are for monitoring purposes only; an indicative value for the compression of the jacket is between 18.3mm and 20.3mm.

4.3. Pre-Test Preparation

- 4.3.1. Suspend the jacket/pelvis impactor so that its longitudinal centreline is parallel, +/- 0.5 degrees, to its line of action plane. Mount the impactor accelerometer on the end of impactor opposite to the impact face and with its sensitive axis in line with its longitudinal centreline.
- 4.3.2. Position the sled system so that the linear guide rails are parallel to the longitudinal centreline of the impactor. Mount the sled accelerometer to the sled with its sensitive axis parallel to the longitudinal centreline of the impactor.
- 4.3.3. With the impactor hanging freely, ensure that its centreline is aligned to the alignment hole on the sled impact plate. In the example in Figure 7 a detachable alignment shaft is attached to the front of the impactor. The line of action centreline shall be 0mm +/- 2mm horizontally and vertically with the impactor centreline at the point of impact.
- 4.3.4. The dummy and the test hardware shall have been in a controlled environment at a between 20.6°C - 22.2°C, and a relative humidity between 10 and 70 percent, for not less than 4 hours prior to testing.
- 4.3.5. Remove the jacket from the dummy. The mass of the jacket, including the 15 torso attachment pins, arm pivot screws and water, shall be 21.87 kg +/- 0.26 kg.
- 4.3.6. Using the spine-torso interface pin holes in the jacket with the pin assemblies that came with the torso jacket assembly, install the jacket onto the jacket core (Figure 8a and 8b) and, using an attachment plate, attach the jacket and jacket core assembly to the impact plate of the sled. The combined mass of the test equipment system and the jacket impact attachment fixture is 55.75 +/- .08 kg. [Does not include the jacket or the spine-torso interface pins].

Figure 8a
Jacket Core Assembly

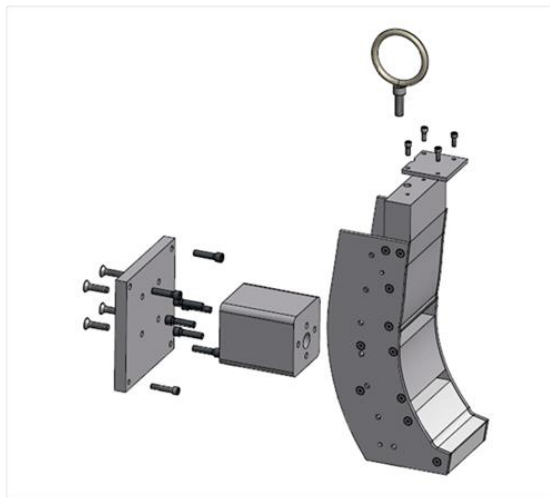
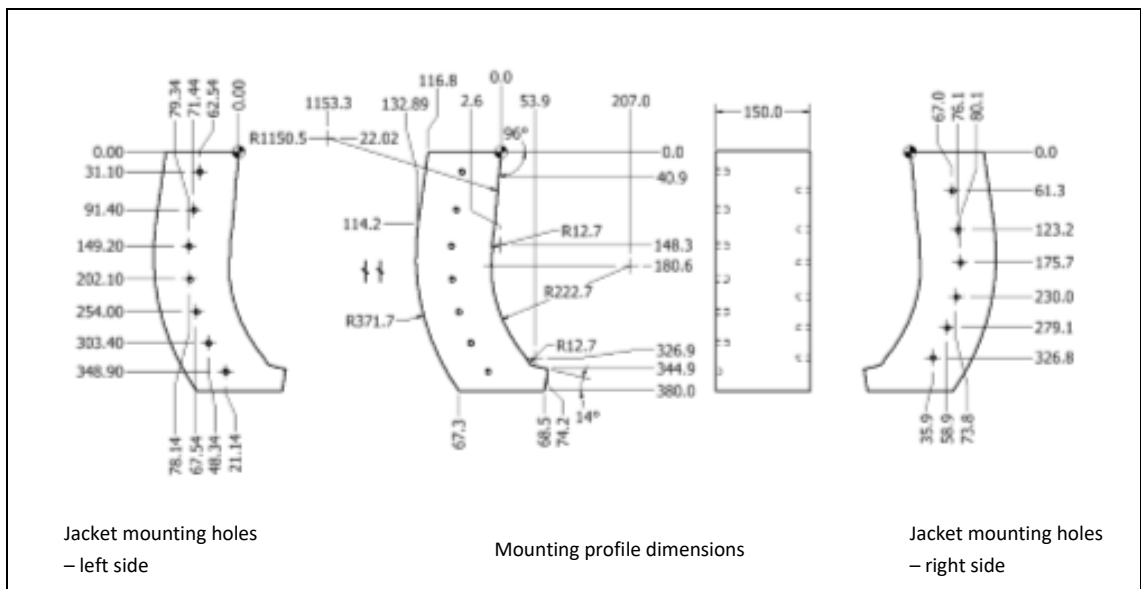

Figure 8b
Jacket Core Dimensions



4.3.6.1. The jacket shall be mounted upside down with its posterior surface facing the sled, as shown in Figure 9a. The jacket pelvis interface abdomen attachment surface shall be 300mm +/- 3mm above the impactor centreline (with the impactor hanging freely) Figure 9b. The jacket shall not contact any part of the test equipment system other than the jacket impact attachment fixture.

Figure 9a
Jacket Test Setup

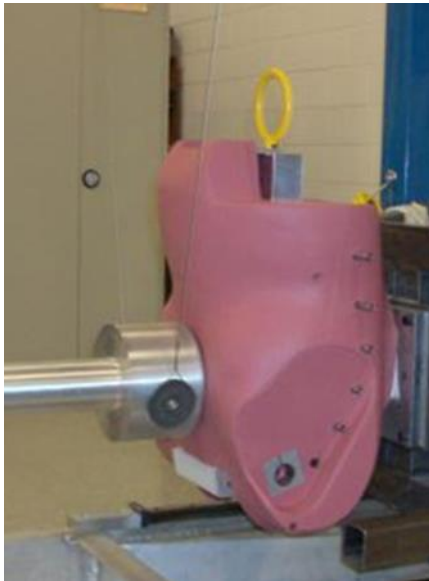
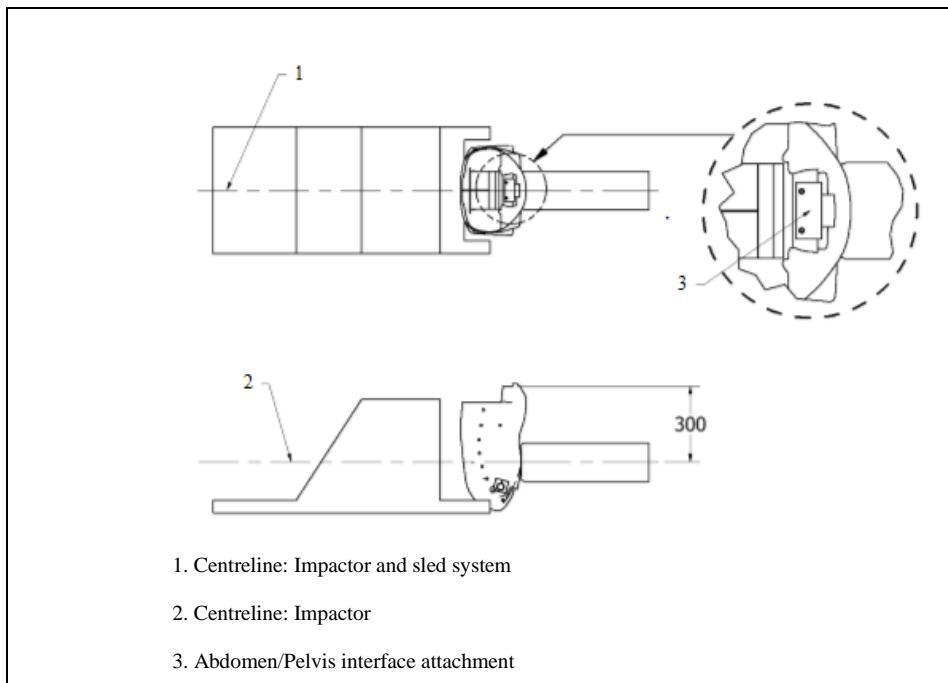

Figure 9b
Jacket Installed Position



- 4.3.6.2. The jacket side to side centreline plane shall be parallel ± 0.5 degrees to the line of action plane of the impactor and shall be within ± 3 mm horizontally from the line of action plane of the impactor.
- 4.3.6. 3. The spine-torso interface pins at location T2 shall be present in the jacket for weight purposes but not used to mount the jacket to the sled.
- 4.3.7. With the impactor hanging freely, slide the sled toward the impactor until the jacket is just touching the impactor face, Figure 9. Ensure that, at this position, the sled shall have a minimum of 500mm of unrestricted forward travel.
- 4.4. Jacket Validation Test Procedure

- 4.4.1. The jacket/pelvis impactor shall be released from a position to achieve an impact velocity as described in Appendix 1, paragraph 1.3.2.6., of between 1.50 – 1.55 m/s. It shall be ensured that the impactor is horizontal +/- 0.5 degrees at the instant of contact between itself and the jacket. The centre of the impactor face shall be within 2mm of the impact site.
- 4.4.2. A time interval of at least 30 minutes shall be provided between successive impacts on the same jacket.
5. Lower Torso Certification Procedures
- The lower torso certification test shall be completed annually.
- 5.1. Lower Torso Response
- The test shall be valid if, when the inferior surface of the pelvis is impacted in accordance with paragraph 4.4.1.,
- (a) The peak impactor force is not less than 3250N and not more than 4620N. The force shall be calculated by the product of the impactor mass and the impactor deceleration.
- (b) The peak sled system velocity is not less than 0.325 m/s and not more than 0.375 m/s.
- 5.2. Compression monitoring
- Pelvis compression, calculated from the difference between the double integrated sled and impactor accelerometers, shall be recorded in the compliance test report (paragraph 7). These data are for monitoring purposes only; an indicative value for the compression of the pelvis is between 17.8mm and 19.5mm.
- 5.3. Pre-Test Preparation
- 5.3.1. Prepare the sled system and lower torso impactor as described for the jacket validation in paragraphs 4.3.1. to 4.3.3. above.
- 5.3.2. The dummy and the test hardware shall have been in a controlled environment at a temperature of between 20.6°C - 22.2°C, and a relative humidity between 10 and 70 percent, for not less than 4 hours prior to testing.
- 5.3.3. Remove the lower torso from the dummy.
- 5.3.4. Using the lower torso test fixture (Figure 10), attach the assembly to the sled impact plate with the posterior surface uppermost (Figure 11). The assembly includes all the components shown in Figure 12.

Figure 10

Lower torso fixture assembly

Figure 11
Lower torso orientation on the sled



Figure 12
Lower torso assembly components

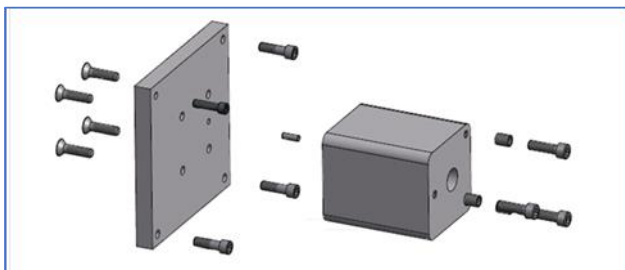
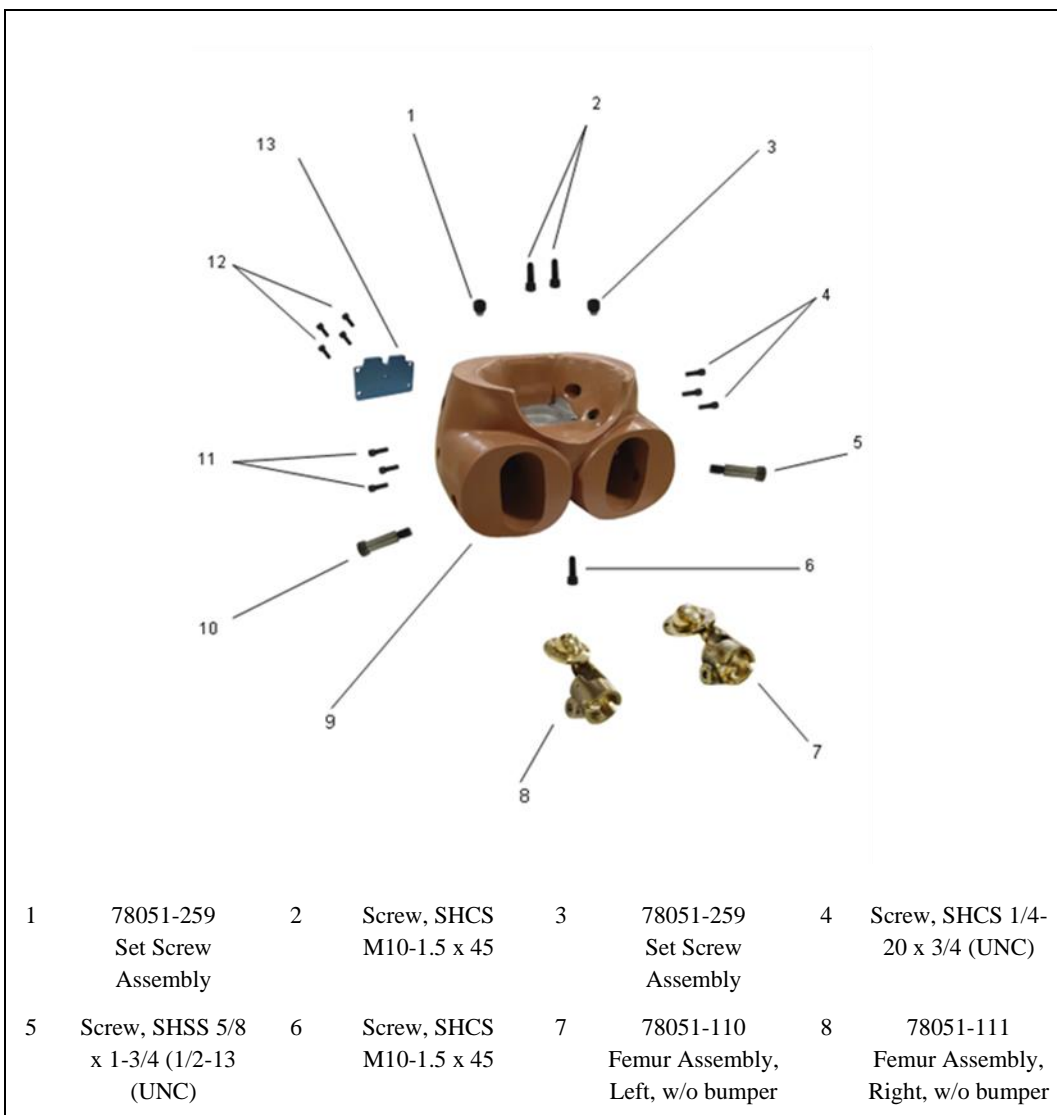

9	App.5/Dwg.025 Pelvis, Moulded, RID	10	Screw, SHSS 5/8 x 1-3/4 (1/2-13 (UNC)	11	Screw, SHCS 1/4- 20 x 3/4 (UNC)	12	Screw, SHCS 10- 24 x 1/2 (UNC)
13	78051-13 Pelvic Cavity Cover						

5.3.4.1. The lower torso side to side centreline plane shall be within +/- 3mm horizontally from the line of action plane of the impactor.

5.3.4.2. The front spine interface plate attachment hole centreline (Figure 13) shall be positioned 23 mm +/- 3mm below the alignment hole on the sled impact plate (Figure 14).

Figure 13

Lower torso assembly

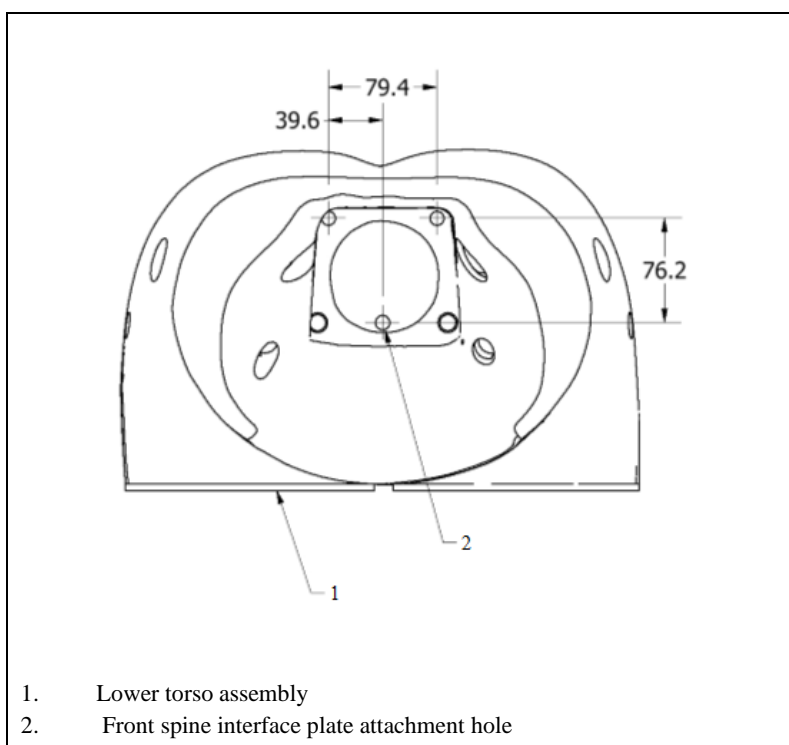

5.3.5. With the impactor hanging freely, position the sled system so the lower torso is just touching the impactor face. Ensure that, at this position the sled has a minimum of 500mm of unrestricted forward travel.

Figure 14
Lower torso test set-up.

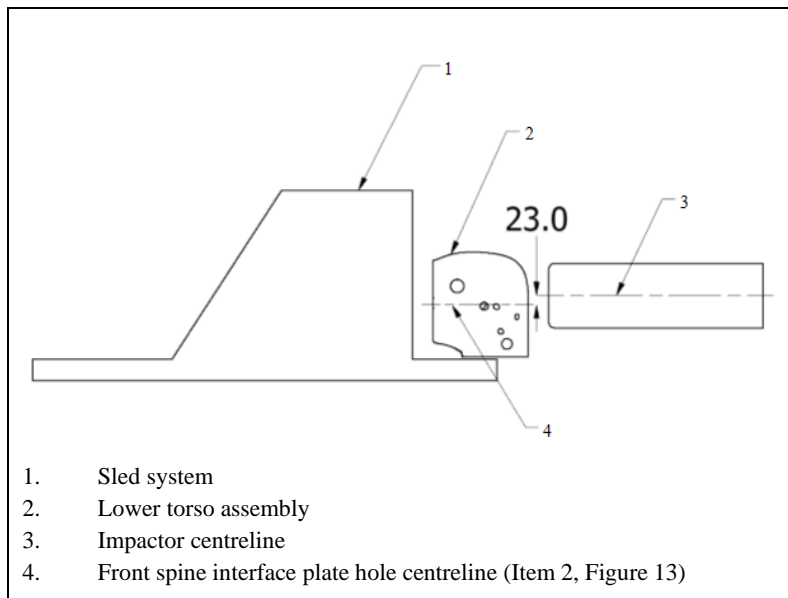

- 5.4. Lower Torso Validation Test Procedure.
- 5.4.1. The lower torso test procedure shall be as described for the jacket validation test in paragraph 4.4.1. above.
- 5.4.2. A time interval of at least 30 minutes shall be provided between successive impacts on the same lower torso.
6. Jacket/Lower Torso Compression Calculation¹
- 6.1. The compression of the jacket, or of the lower torso, is established by subtracting the displacement of the sled from the displacement of the impactor during the impact tests described in paragraphs 4 and 5 respectively. The individual displacement values are determined by manipulation of the acceleration/time history recorded during those tests.
- 6.2. The acceleration data shall be recorded in units of m/s^2 , with recording starting at a time of 150ms (t_{-150}) before the point of initial contact (t_0). Recording shall continue at least until the acceleration curve passes through zero (Figure 15). This timeframe shall be used for all the data manipulations that follow.

Determination of Initial Contact (t_0).

Initial contact (t_0) is defined as the time at which the CFC1000 forward filtered value of acceleration reaches $9.81m/s^2$.

¹ This procedure was used when establishing the indicative compression values of paragraphs 4.2. and 5.2. The compression assessment is for monitoring purposes only. This procedure, and the indicative values, should be reviewed and revised if the compression measurement is adopted subsequently as a requirement.

Figure 15
Impactor Acceleration Curve: Determination of t_0 and data range.

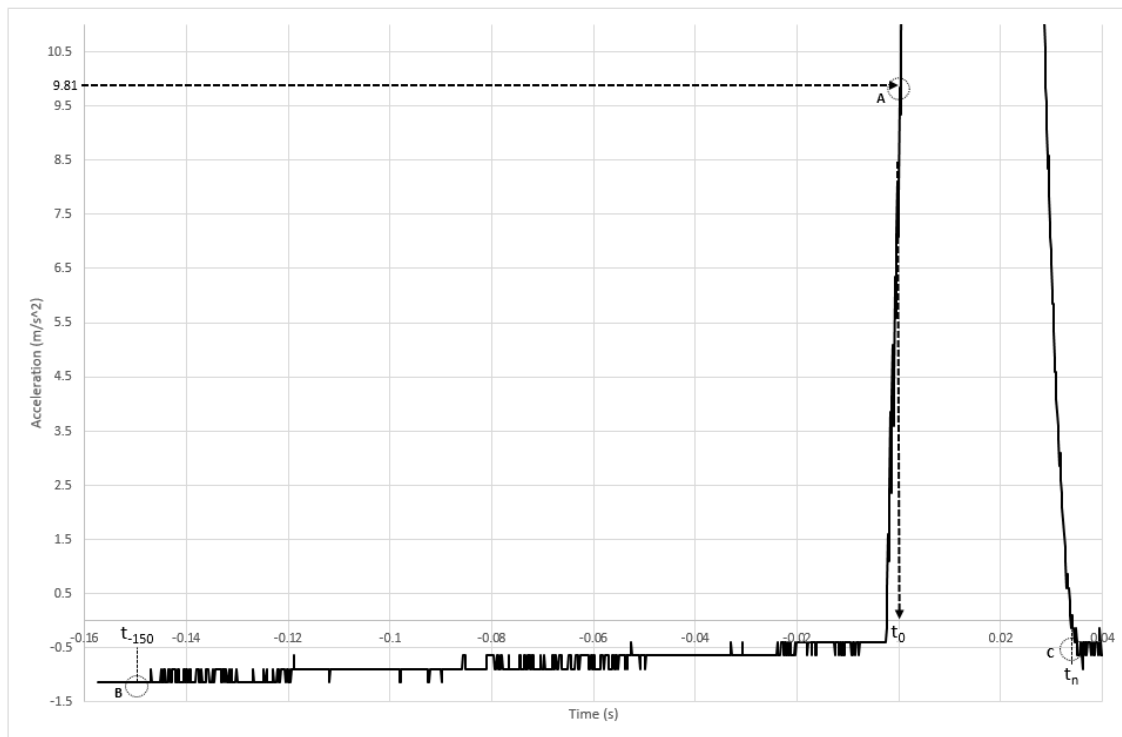

A = Acceleration reaches 9.81 ms²; B = Start of data capture (t-150ms);

C = Acceleration rate reaches zero (minimum data range)

Where t_0 results in a time offset from the instrumented time data, this offset shall be used for all the data channels.

After establishing t_0 , any channel bias shall be removed by zeroing all channels using the average of 20ms of data immediately before t_0 .

6.3. Impactor Velocity

The velocity/time curve of the impactor and of the impactor and the sled shall be determined by integration of the accelerometer data. However, in the case of the impactor, it is necessary to add its velocity (initial velocity) at the time that the acceleration data capture begins (t-150ms). This initial impactor velocity shall be established from the velocity measurement instrument described in paragraph 2.5. and installed as described in Appendix 1, paragraph 1.3.2.6.

$$V_{impactor}(t) = V_{initial} + \int_{t-150}^{t_n} A_{impactor}(t)dt$$

Where:

$V_{initial}$ = the average velocity measured by instrumentation at a position 110 +/- 20 mm from position of the front face of the impactor when it is hanging freely, as described in paragraph 4.3.7.

$A_{impactor}$ = the impactor acceleration data captured between t-150 and (at least) the time when the acceleration of the impactor reaches zero.

Figure 16
Impactor Velocity Curve (including initial velocity at t=150 ms (A)).

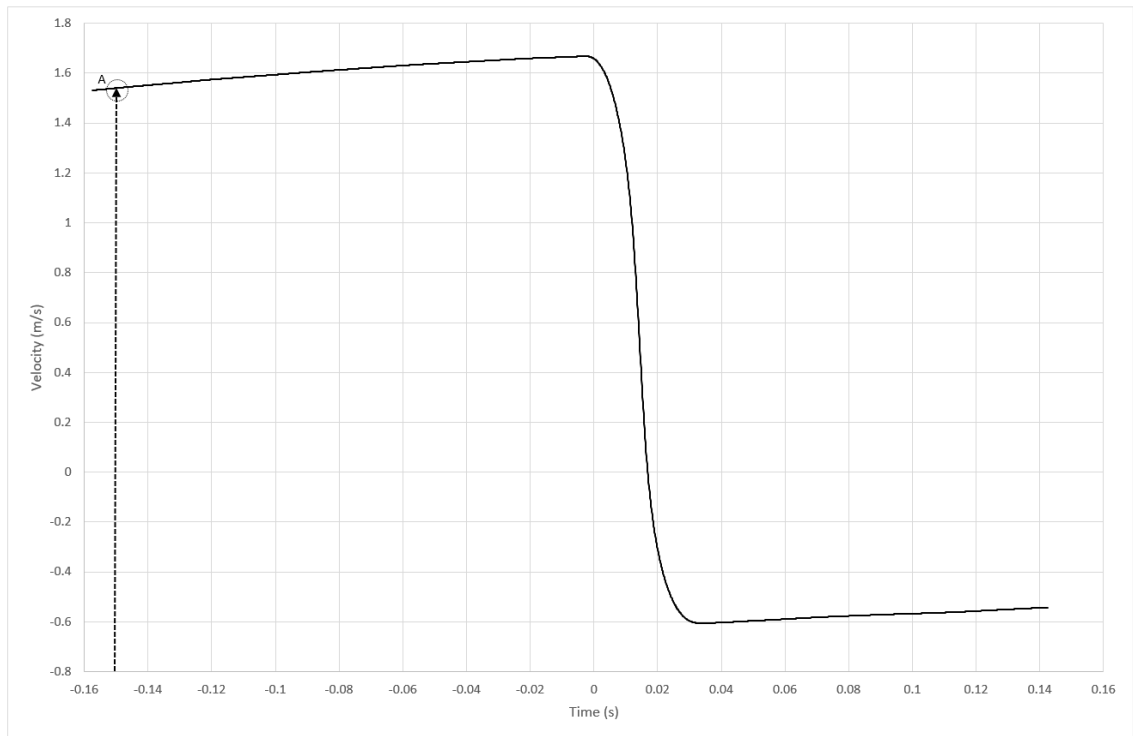

6.4. **Impactor Displacement**

The displacement of the impactor shall be determined by integration of the impactor velocity/time curve

$$D_{impactor}(t) = \int_{t_{-150}}^{t_n} V_{impactor}(t) dt$$

Where:

$V_{impactor}$ = the impactor velocity data determined by the procedure in paragraph 6.3.

The calculation above will result in an offset displacement curve. This offset shall be corrected so that the curve passes through zero at t_0 (Figure 17, point B).

$$D_{impactor(zeroed)}(t) = D_{impactor}(t) - D_{impactor\ t_0}$$

Where:

$D_{impactor}$ = the impactor velocity data determined by the procedure in paragraph 6.4.

$D_{impactor\ t_0}$ = the value of $D_{impactor}$ at t_0 (Figure 17, point A)

Figure 17
Impactor Displacement Curve with offset removed, (A → B)

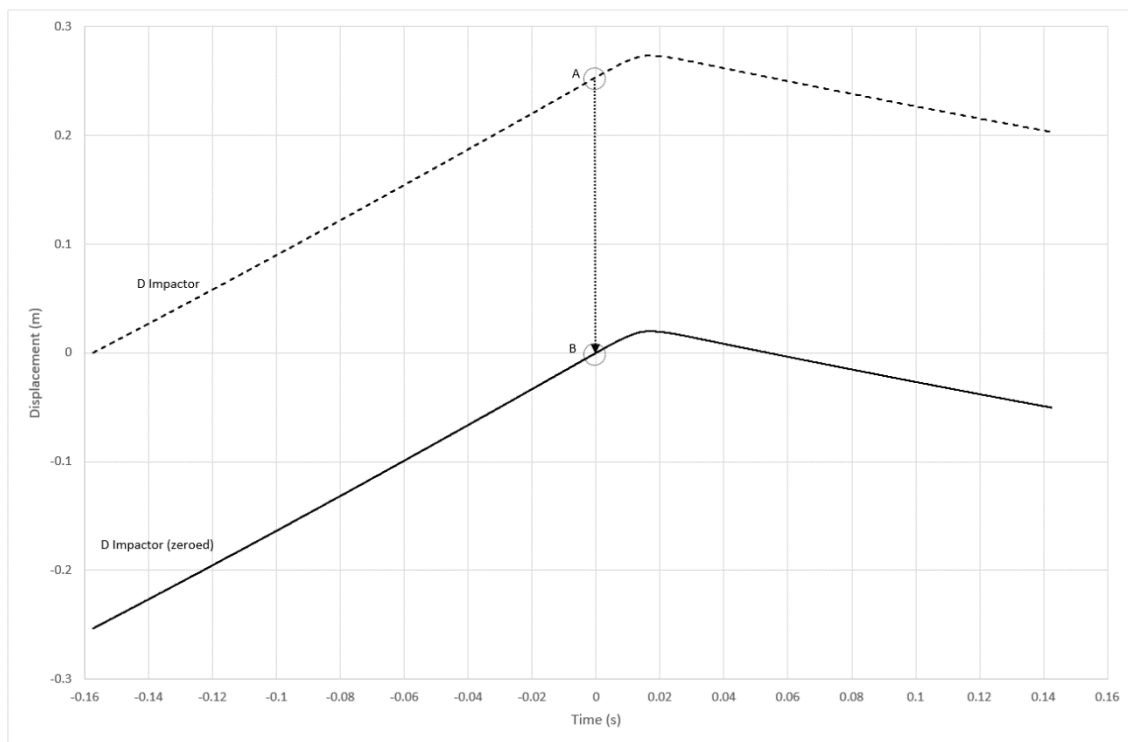

6.5. Sled Velocity

The velocity/time curve of the sled shall be determined by integration of the sled accelerometer data.

$$V_{sled}(t) = \int_{t_{-150}}^{t_n} A_{sled}(t) dt$$

Where:

A_{sled} = the sled acceleration data captured between t-150 and (at least) the time when the acceleration of the impactor reaches zero.

This may result in an offset from noise or bias in the acceleration signal. This offset shall be removed so that the curve passes through zero at t_0 , Figure 18, (A → B).

$$V_{sled(zeroed)}(t) = V_{sled}(t) - V_{sledT0}$$

Where:

V_{sled} = the impactor velocity data determined by the procedure in paragraph 6.5.

$V_{sled t0}$ = the value of V_{sled} at t_0 .

Figure 18
Sled Velocity Curve with offset removed

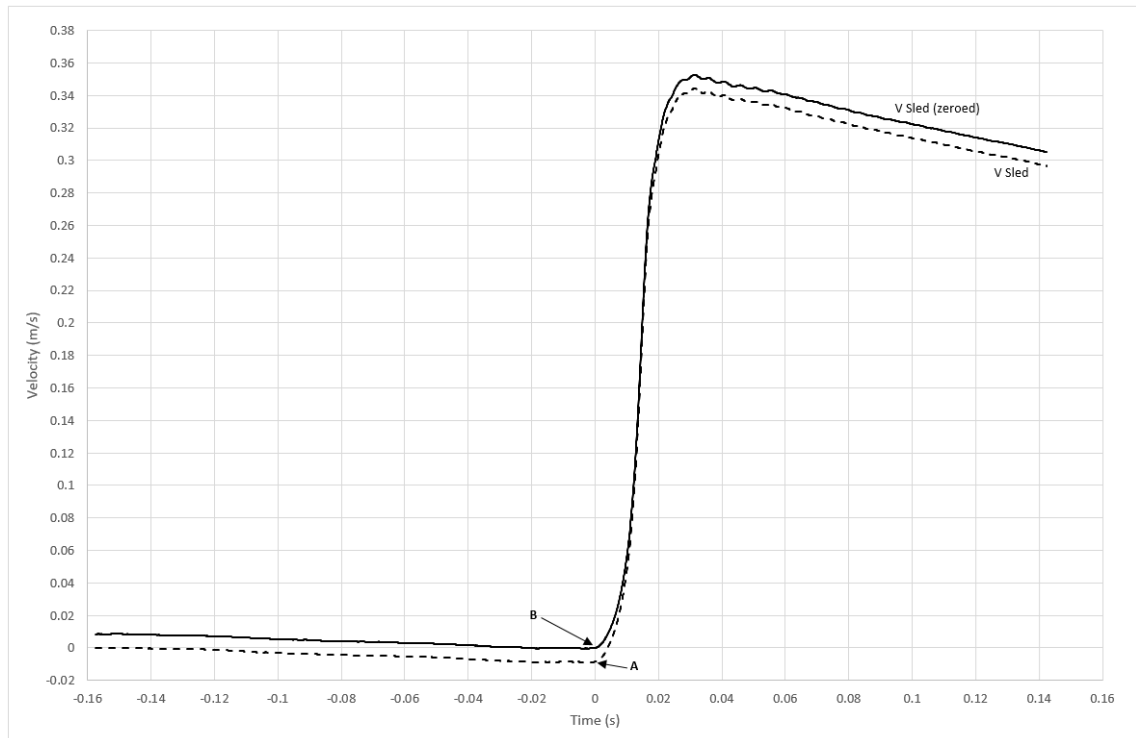

6.6. Sled Displacement

The displacement of the sled shall be determined by integration of the sled velocity data described in paragraph 6.5.

$$D_{sled}(t) = \int_{t_{-150}}^{t_n} V_{sled(zeroed)}(t) dt$$

Where:

$V_{sled(zeroed)}$ = the offset corrected value for velocity determined by the procedure in paragraph 6.5.

Note: The sled is stationary at t_{-150} and so the initial velocity is zero.

The calculation above may result in an offset displacement curve. This offset shall be corrected so that the curve passes through zero at t_0 (Figure 19, point B).

$$D_{sled(zeroed)}(t) = D_{sled}(t) - D_{sled t_0}$$

Where:

D_{sled} = the sled displacement data determined by the procedure above.

$D_{sled t_0}$ = the value of D_{sled} at t_0 .

Figure 19
Sled Displacement

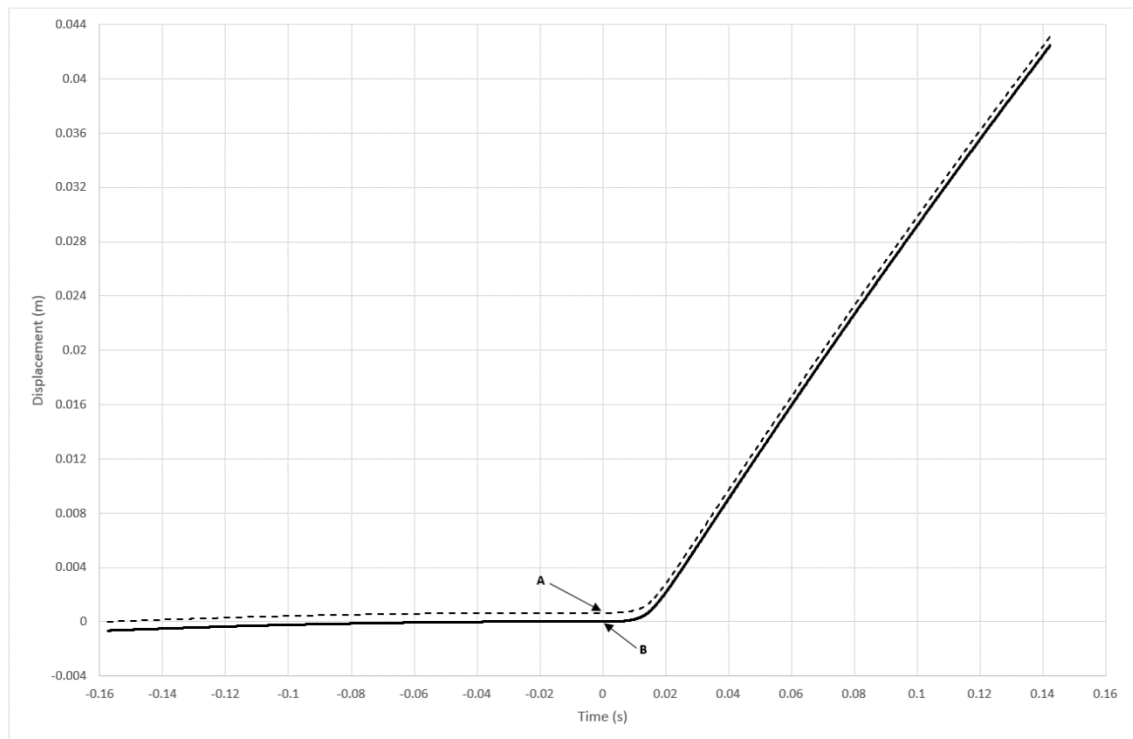

6.7. Compression

With the data aligned at t_0 , calculate the compression value with respect to time.

$$compression(t) = D_{probe(zeroed)}(t) - D_{sled(zeroed)}(t)$$

Where:

$D_{probe(zeroed)}$ = the value determined in 6.4. above.

$D_{sled(zeroed)}$ = the value determined in 6.6. above.

The results shall then be converted from meters (m) to millimeters (mm) and plotted. The peak compression shall be deduced from the peak of the resulting curve.

Figure 20
Displacement and Compression Curves.

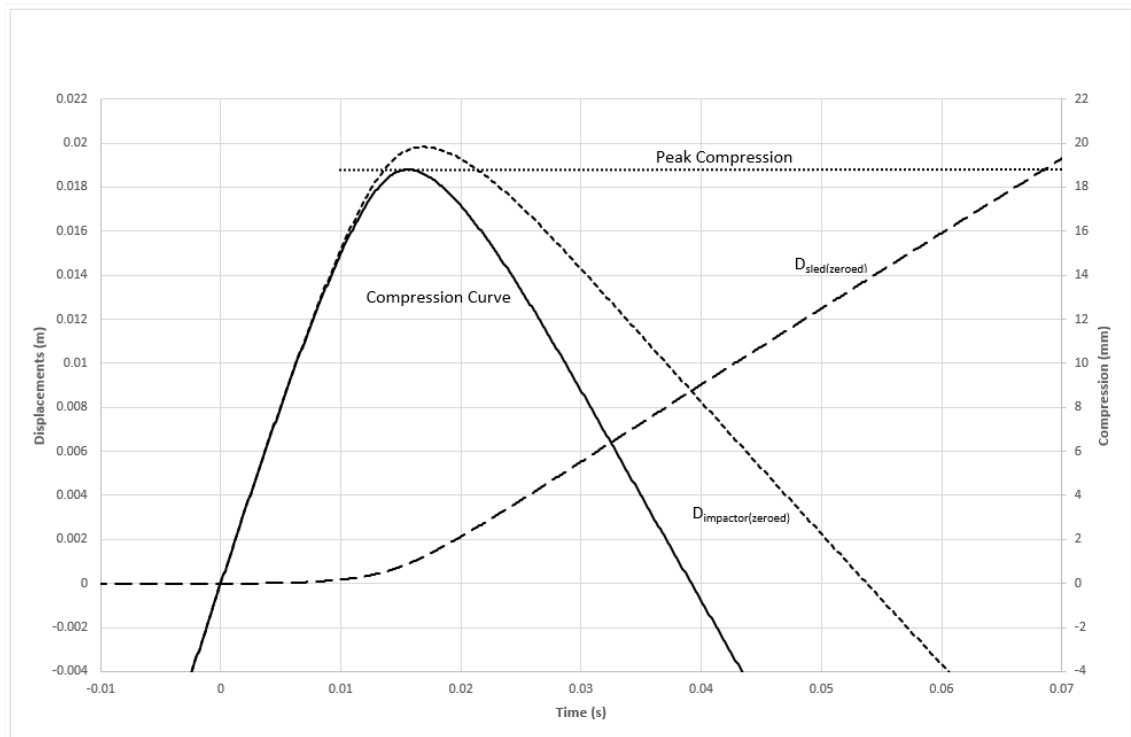

7. Certification Test Report Detail

The following list contains the minimum information to be provided with the certification test report of a BioRID-II UN dummy:

Part A. Detail

1. BioRID-II UN Serial Number
2. Date of Certification
3. Certifying Organisation
4. Laboratory Location
5. Tests Completed:
 - 5.1. BioRID-II UN Certification (Part B) Yes/No
 - 5.2. Jacket Certification (Part C) Yes/No
 - 5.3. Lower Torso Certification (Part D) Yes/No
6. Replacement date for the front neck bumpers (C1 – C7) and the front thoracic bumper (T1).
7. Replacement date for the remaining spinal bumpers.
8. Next certification date for the jacket. (12-months from the date of issue)
9. Next certification date for the lower torso. (12-months from the date of issue)
10. Next calibration date for the head accelerometer.
11. Next calibration date for the cervical (T1) accelerometers;
 - 11.1. T1- Left,
 - 11.2. T1-Right.
12. Next certification date for the BioRID-II UN.
 (No later than 12-months from the date of issue or later than the earliest date shown for items 6 to 11 above), whichever occurs first.

13. Laboratory Manager signature

Part B. BioRID-II UN Certification

14. Dimensional Conformity Requirements (Paragraph 2.2.) are met. Yes/No.
15. The maximum T1 X axis acceleration and the time that it occurs.
16. The peak head rotation about the occipital condyle and the time that it occurs.
17. The maximum and minimum head rotation in the interval between 125 ms and 135 ms after initial contact.
18. The peak neck link rotation and the time that it occurs.
19. The peak neck link rotation:
- 19.1. The minimum recorded value for neck link rotation (potentiometer B),
- 19.2. The maximum neck link rotation (potentiometer B) in the interval between 98 ms and 108 ms after initial contact,
- 19.3. The maximum neck link rotation (potentiometer B) in the interval between 165 ms and 175 ms after initial contact.
20. T1 rotation:
- 20.1. The minimum recorded value for the T1 rotation (potentiometer C),
- 20.2. The maximum T1 rotation (potentiometer C) in the interval between 73 ms and 78 ms after initial contact.
21. The total head rotation:
- 21.1. The minimum total head rotation in the interval between, 100 ms and 190 ms,
- 21.2. The maximum total head rotation in the interval between 100 ms and 110 ms,
- 21.3. The maximum total head rotation in the interval between 170 ms and 190 ms.
22. The total thoracic rotation:
- 22.1. The minimum recorded value for the total thoracic rotation,
- 22.2. The maximum total thoracic rotation in the interval between 125 ms and 135 ms,
23. The maximum upper neck moment (My) and the time that it occurs.
24. The minimum upper neck moment (My) and the time that it occurs.

Part C. Jacket Certification

25. The peak impactor force.
26. The peak sled system velocity.
27. The peak jacket compression value

Part D. Lower Torso Certification

28. The peak impactor force.
29. The peak sled system velocity.
30. The peak lower torso assembly compression value.

Appendix 1

1. BioRID-II UN Sled and Track System Validation

The sled and track system to be used to certify the BioRID-II UN dummy, and to validate the dummy jacket and lower torso shall itself be validated. The validation ensures that the rails, sled and energy transfer device are correctly installed and functioning. This validation shall be completed according to the following procedures and prior to performing any of the certification tests.

A dummy equivalent fixed mass package shall be used during this validation procedure. The dummy equivalent fixed mass package provides equivalent inertia for the sled assembly to that provided by the BioRID-II UN upper torso and head assembly. Its mass, including attachment hardware, shall be 25.50 kg +/- 0.02 kg

1.1. Test Conditions

The test shall be valid if, when the energy transfer device is impacted in accordance with paragraph 1.3.1. below, the results of the tests set out below satisfy the following limits:

- (a) When the energy transfer device, is impacted, the peak impactor force shall not be less than 8600 N and no more than 9800 N. The force shall be calculated by the product of the impact probe mass and the impact probe deceleration.
- (b) The peak test equipment system acceleration shall be between 118 m/s² and 136 m/s².
- (c) The peak test equipment system velocity shall be 2.8 m/s +/- 0.15 m/s
- (d) The test equipment system velocity decay (calculated from the slope of the sled velocity curve) between 50 ms and 150 ms shall not decay more than -1.5 m/s².

1.2. Pre-Test Preparation

1.2.1. Attach the equivalent mass package to the dummy mounting plate on the sled.

1.2.2. Prepare the sled system, together with the dummy impactor.

1.2.2.1. Suspend the dummy impactor so that its longitudinal centreline is parallel +/- 0.5 degrees to the impactor's line of action plane. Mount the impactor accelerometer on the end of impactor opposite to the impact face and with its sensitive axis in line with its longitudinal centreline.

1.2.2.2. Position the sled system so that the linear guide rails are parallel to the longitudinal centreline of the impactor. Mount the sled accelerometer to the sled with its sensitive axis parallel to the longitudinal centreline of the impactor.

1.2.2.3. With the impactor hanging freely, ensure that its centreline is aligned to the alignment hole on the sled impact plate. In the example in Figure 1 a detachable alignment shaft is attached to the front of the impactor. The line of action centreline shall be 0mm +/- 2mm horizontally and vertically with the impactor centreline at the point of impact when mounted to the sled system.



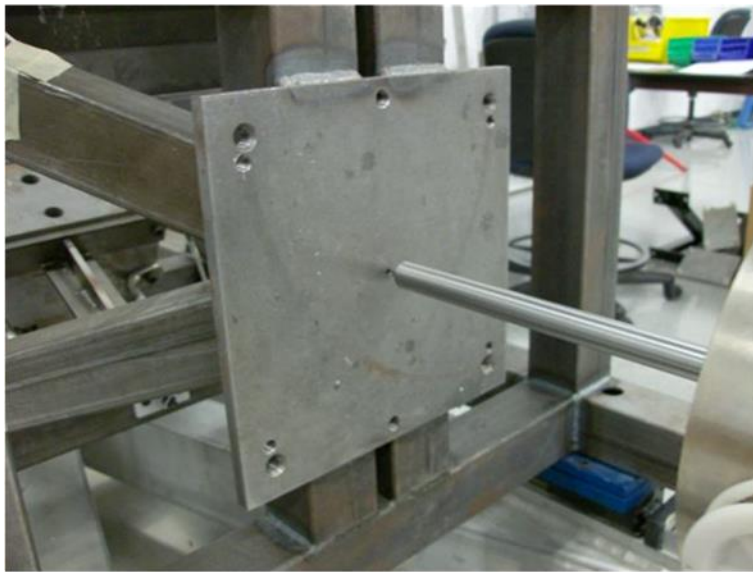

Figure 1
Impact Probe Alignment











- 1.2.2.4. Attach the energy transfer device to sled impact plate. The side to side centreline plane of the energy transfer device shall be parallel ± 0.5 degrees to the line of action plane of the impactor.
- 1.2.2.5. With the impactor hanging freely, slide the sled toward it until the energy transfer device is just touching the impactor face. Ensure the sled has at least 500 mm of unrestricted travel in the direction of flight of the impactor.
- 1.2.2.6. Install a velocity measurement instrument (e.g. a light trap) to measure the average impactor velocity as it approaches the contact point. The instrument shall be positioned at 110mm ± 20 mm measured horizontally from the position of contact between the impactor and the energy transfer device, established in paragraph 1.2.2.5. above.
- 1.2.3. Soak all hardware in a controlled environment at any temperature between 20.6°C - 22.2°C and a relative humidity between 10 and 70 percent for not less than 4 hours prior to testing.
- 1.3. Sled and Track System Validation Test Procedure
 - 1.3.1. The dummy impactor and impactor face assembly shall be released from a position to achieve a velocity as described in 1.2.2.6., of between 4.7 m/s and 4.8 m/s. It shall be ensured that, at the instant of contact with the energy transfer device, the longitudinal plane of the impactor is ± 0.5 degrees relative to the vertical and horizontal planes.
 - 1.3.2. Wait at least 30 minutes between successive impacts on the energy transfer device.

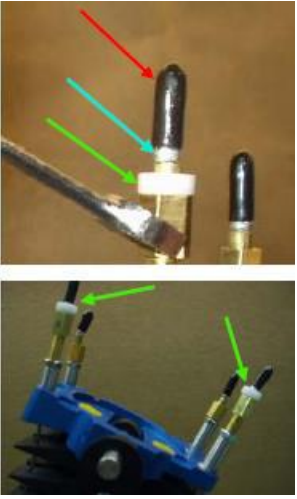

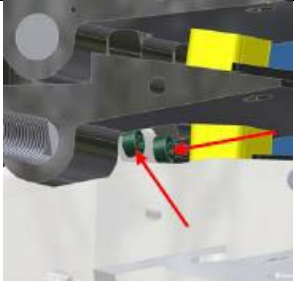
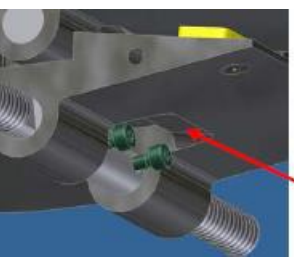

Appendix 2





Part 1. BioRID-II UN Design Checklist

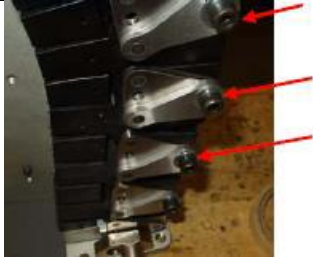

BioRID-II UN Design Checklist		
	<p>Verify the skull cap is for the BIORID-II UN, and that it has the correct size cable clearance slot.</p> <p>Refer to App.2/Dwg.005, App.2/Dwg.007</p>	
	<p>Verify skull and cap contains the error proofing pin-hole combination.</p> <p>Refer to App.2/Dwg.009, App.2/Dwg.005, and App.2/Dwg.007</p>	
	<p>Verify the correct size holes in the head to clear the front cable adjusters (12.7 mm).</p> <p>Refer to App.2/Dwg.005</p>	
	<p>Verify the correct head is installed (non-skull cap load cell version).</p> <p>Refer to App.2/Dwg.004</p>	
	<p>Verify the correct head skin is being used with a cut out under the chin (not a Hybrid III 50th Percentile head skin).</p> <p>Refer to App.2/Dwg.009</p>	
	<p>Verify that the occipital condyle plate has clearance for the instrumentation cables.</p> <p>Refer to App.2/Dwg.003</p>	

		
	<p>Verify the presence of occipital condyle pin set screws. Refer to App.2/Dwg.003</p>	
	<p>Verify head skin is trimmed to avoid mechanical load path around upper neck load cell.</p>	
	<p>Verify that plastic caps and aluminium crimps are still in place on top of all four cables above the adjusters in the head, and that both Delrin sleeves are in place on both muscle substitute cable adjusters. Refer to App.1/Dwg.005, and to paragraph 1.4.3.</p>	
	<p>Verify the proper occipital condyle plate is installed. The thickness should be 17.6 mm. If is less than 17 mm, it should be replaced. Refer to App.2/Dwg.003</p>	
	<p>Verify that presence of the M2.5-0.45 x 8 SHCS that lock the T1 pin in place, and that they are tight. Refer to App.1/Dwg.005</p>	

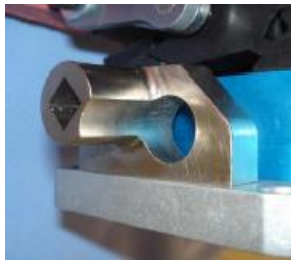
		
	<p>Verify that the bottom of the C7 vertebrae has clearance for the T1 locking screws.</p> <p>Refer to App.1/Dwg.005, App.3/Dwg.008</p>	
	<p>Check the cervical vertebrae dimensional thicknesses front (15.3 +/- 0.25mm) and back (1.2 +/- 0.25mm) and verify with drawings</p> <p>Refer to App.3/Dwg.004, App.3/Dwg.005, App.3/Dwg.006, App.3/Dwg.007, and to App.3/Dwg.008</p>	
	<p>Verify the T1 load cell or structural replacement design with removable bushings and slots to allow removal without cutting cables</p> <p>Refer to App.4/Dwg.009, and to paragraph 1.2.</p>	
	<p>Verify that stainless steel neck pins are used to prevent corrosion effects</p> <p>Refer to App.3/Dwg.009, and to App.3/Dwg.011</p>	



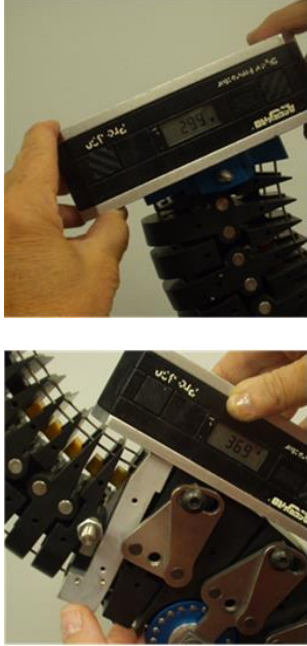

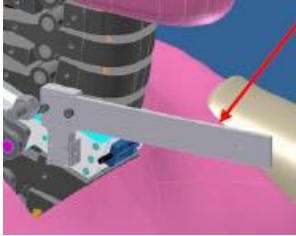
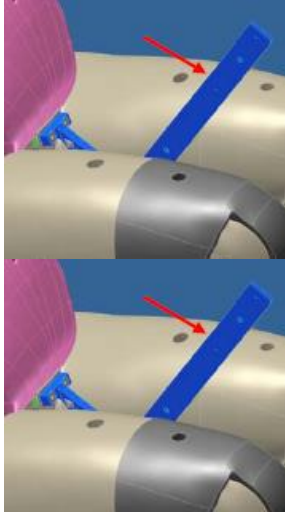
	<p>Check the cervical vertebrae holes with gauge pins: The 8.0000 +.0010/-0.0000 mm dia. should go in using a light single finger force.</p> <p>The 8.0300 + .0010/-0.0000 mm dia. should not go in using a light single finger force.</p> <p>Refer to App.3/Dwg.004, App.3/Dwg.005, App.3/Dwg.006, App.3/Dwg.007, and to App.3/Dwg.008</p>	
	<p>Verify damper (App.6/Dwg.009) is Installed, identified by presence of clamping block</p> <p>Note that some damper units have only one M3 set screw to clamp the cable to the damper; these older units do not comply with the BioRID-II UN specification, which requires two such screws.</p> <p>Refer to App.6/Dwg.009 and to App.6/Dwg.011</p>	
	<p>Verify the presence of a lock washer under the M8 damper attachment screw.</p> <p>Refer to App.6/Dwg.009</p>	
	<p>Verify the presence of a slot in the T3 torsion plate for muscle substitute cable sheath clearance.</p> <p>Refer to App.4/Dwg.011 and to App.1/Dwg.005</p>	
	<p>Verify the damper cable guide wheel is the correct size/design/revision.</p> <p>Refer to App.6/Dwg.002</p>	
	<p>Verify the torsion plate fasteners are SHCS with washers BHCS shall not be used.</p> <p>Refer to App.1/Dwg.005, and to paragraph 1.3.</p>	





		
 	<p>Verify that the S1 screw includes the tension washer and that the screw is torqued to the proper specification.</p> <p>Refer to App.1/Dwg.005, and to paragraph 1.3.</p>	
	<p>Verify the H Point locators installed comply with drawings;</p> <p>Refer to App.5/Dwg.028, App.5/Dwg.029 and App.1/Dwg.005</p>	
	<p>Verify S1 is present, which uses a lumbar load cell or structural replacement to improve durability and interchangeability.</p> <p>Refer to App.4/Dwg.042, App.4/Dwg.044, App.1/Dwg.005, and to paragraph 1.3.</p>	
	<p>If fitted, remove the C4 Accelerometer and mount. This will cause a load path around upper neck load cell and produce erroneous results.</p>	

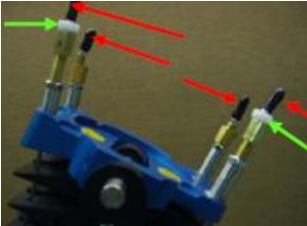

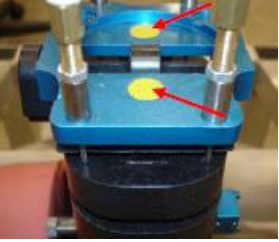

	<p>Setup the spine by carefully following the setup procedure.</p> <p>Refer to paragraph 1.5.5.</p>	
	<p>Verify the correct jacket version is in use (the arms will hang straight down).</p> <p>Refer to App.5/Dwg.021 and to App.1/Dwg.004</p>	
	<p>Verify the use of correct T1 angle indicator is attached to accelerometer mount location</p> <p>Refer to App.9/Dwg.013</p>	
	<p>Verify use of the correct pelvis angle indicator (updated to clear the belt).</p> <p>Refer to App.9/Dwg.008</p>	

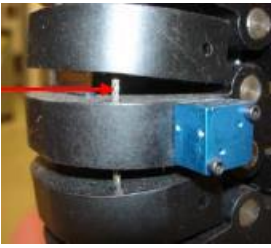

	<p>Ensure that shoes satisfy the following:</p> <p>Men's dress Oxford type, US size 11 (European size 45) extra wide fit, meeting military specifications MIL-S-13192P, and weighing 0.57 ± 0.1 kg with an overall length of 320–325mm.</p>	

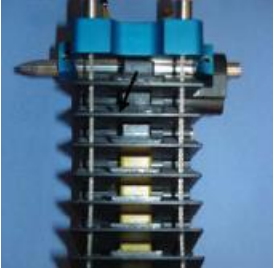
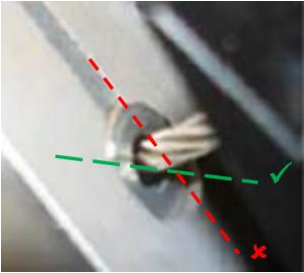

Part 2. BioRID-II UN Maintenance Checklist



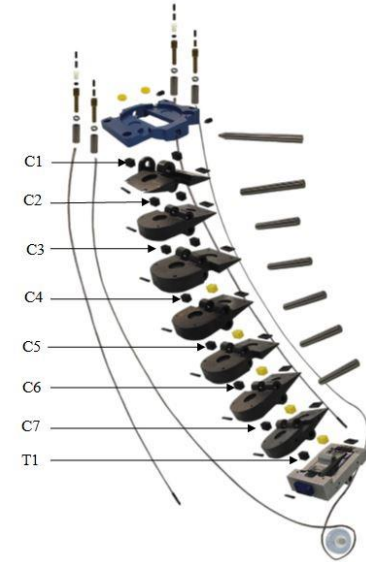

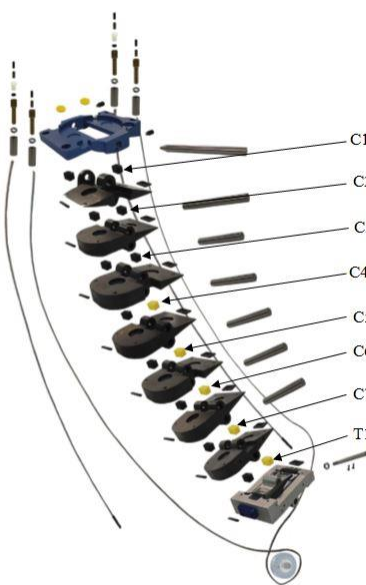
APPENDIX 2 - BioRID II Maintenance Checklist		
	<p>Verify the skull cap is the dedicated version for BIORID-II UN, and that it has the correct size cable clearance slot.</p> <p>Refer to App.2/Dwg.005 and App.2/Dwg.007</p>	
	<p>Verify the head skin is cut out under the chin: this differs from the HIII 50th head skin.</p> <p>Refer to App.2/Dwg.004</p>	
	<p>Verify the head mass assembly with accelerometers is 4.540 +/- 0.045kg</p>	
	<p>Verify that the plastic caps are still in place on the top of all four cables above the adjusters in the head, and that both Delrin sleeves are in place on both muscle substitute cable adjusters.</p> <p>Refer to App.1/Dwg.005 and to paragraph 1.4.3.</p>	
	<p>Verify that the 4 locknuts on the occipital condyle plate cable adjusters are tight.</p> <p>Refer to paragraph 1.4.3.</p>	
	<p>Verify the presence and good condition of the load cell/occipital condyle plate bumpers. If the yellow bumpers are compressed the head will rock.</p>	

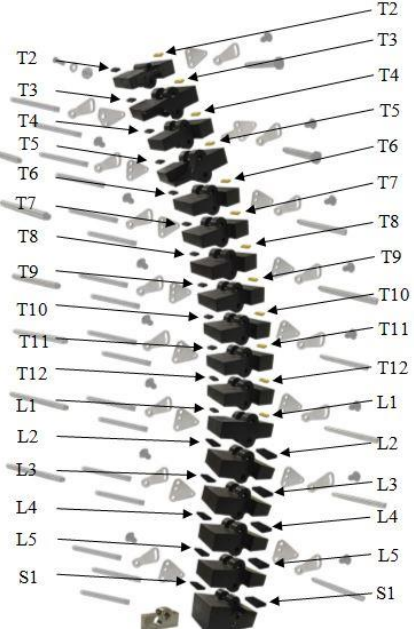

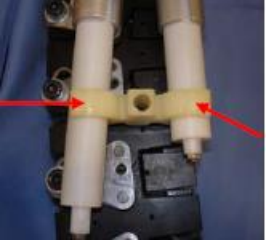
	<p>Verify that there is no play between the occipital condyle plate and the head when the pin is installed. Replace if necessary.</p> <p>Refer to App.2/Dwg.006</p>	
	<p>Verify that the M8 damper mounting screw is tight and torqued to 6.8 Nm</p> <p>Refer to paragraph 1.4.4.</p>	
	<p>Verify that the damper cable is secure in the slot of the damper body and the two clamping screws are tightened</p> <p>Note that some damper units have only one M3 set clamping screw; these older units do not comply with the BioRID-II UN specification.</p> <p>Refer to paragraph 1.4.4.</p>	
	<p>Verify that the serrated lock washer is under the M8 damper attachment screw</p> <p>Refer to App.6/Dwg.009 and to paragraph 1.4.4.</p>	
	<p>Verify that the damper clamp tongue is positioned correctly in the slot</p> <p>Refer to App.6/Dwg.009 and to paragraph 1.4.4.</p>	
	<p>Verify that there are no kinks or bends and no damage in any of the cable assemblies. Avoid twisting the cables during the dummy setup</p> <p>Refer to paragraph 1.4.3.</p>	

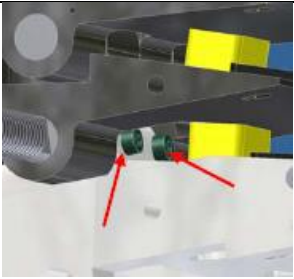
	<p>Verify the presence and correct position of all cervical bumpers in the neck assembly. Check both front and back.</p> <p>Refer to App.1/Dwg.005 and to paragraph 1.2.3.</p>	
	<p>Verify that the T1 cable bushings are not clamped so that the split between halves is parallel to the sides of T1, as the cable can ride on the split resulting in drag</p> <p>Refer to App.4/Dwg.009 and to paragraph 1.5.2.</p>	
	<p>Check to see if there is excessive wear on the T1 cable bushings, i.e. they are oval in appearance</p> <p>Refer to paragraph 1.5.2.</p>	
	<p>Verify that the split bushings are tight in the replaceable T1 load cell</p> <p>Refer to paragraph 1.5.2.</p>	
	<p>Check cervical vertebrae holes with gauge pins: The 8.0000 +.0010/-0.0000 mm dia. gauge should go in with a light single finger force. The 8.0300 + .0010/-0.0000 mm dia. should not go in using light single finger force.</p> <p>Refer to App.3/Dwg.004, App.3/Dwg.005, App.3/Dwg.006, App.3/Dwg.007 and to App.3/Dwg.008</p>	
	<p>Confirm the age of the front neck bumpers (C1 – C7) and the front thoracic bumper (T1).</p> <p>These bumpers must be replaced every 12 months.</p> <p>Refer to paragraph 1.2.3.</p>	

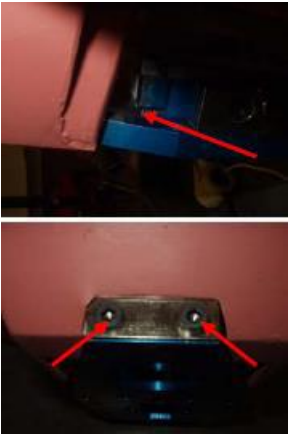

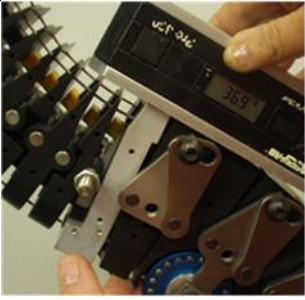
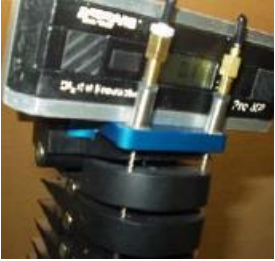

		
	<p>Verify that all torsion plate fasteners are tight on both sides of the dummy (including the lowest lumbar screw noted with an arrow).</p> <p>Refer to App.1/Dwg.005 and to paragraph 1.5.</p>	
	<p>Confirm the age of the rear cervical bumpers and those in the thoracic and lumbar area.</p> <p>Bumpers other than the front neck bumpers (C1 – C7) and the front thoracic bumper (T1) (see above), must be replaced every 24 months.</p> <p>Verify the presence and correct position of all bumpers in the thoracic and lumbar area. Check both front and back of spine.</p> <p>Refer to App.1/Dwg.005 and to paragraph 1.3.</p>	

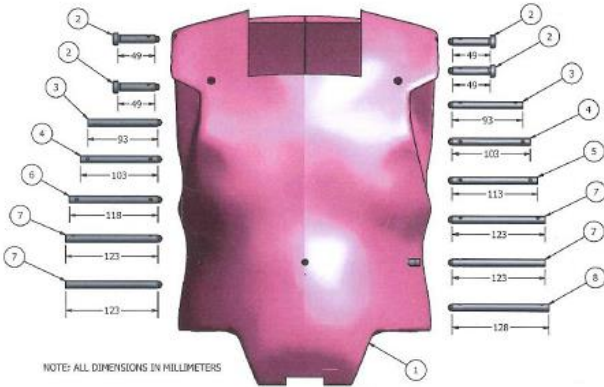



 <p>Diagram showing an exploded view of a mechanical assembly. The parts are labeled as follows: T2, T3, T4, T5, T6, T7, T8, T9, T10, T11, T12, L1, L2, L3, L4, L5, and S1. The labels are arranged in two columns, with arrows pointing to the corresponding parts in the assembly.</p>		
 <p>Close-up photograph showing a cable ferrule being inserted into a T3 vertebra. Red arrows point to the ferrule and the vertebra.</p>	<p>Verify that the muscle substitute cable ferrules are glued securely into the T3 vertebra.</p> <p>Refer to App.1/Dwg.005 Refer to paragraph 1.4.</p>	
 <p>Close-up photograph showing a spring housing holder on an adjacent SHCS. A red circle highlights the holder.</p>	<p>Verify that the spring housing holder does not ride up over the end of the adjacent SHCS.</p> <p>Refer to paragraph 1.4.</p>	
 <p>Close-up photograph showing a spring housing coupling. Red arrows point to the coupling.</p>	<p>Check to see if the spring housing coupling is deformed allowing the housings to snap out.</p> <p>Refer to paragraph 1.4.</p>	
	<p>Verify that the M2.5-0.45 x 8 SHCS that lock the T1 pin in place are tight.</p> <p>Refer to App.1/Dwg.005 and to paragraph 1.2.</p>	

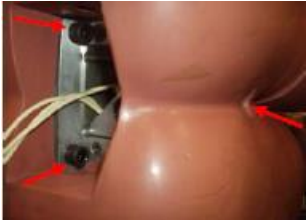

		
	<p>Verify that the S1 screw includes the tension washer and that it is torqued to the proper specification. Refer to App.1/Dwg.005</p> <p>Refer to paragraph 1.3.</p>	
	<p>Verify that the 2 nuts on the spring cable threaded studs are installed and tight.</p> <p>Refer to App.1/Dwg.005 and to paragraph 1.4.3.</p>	
	<p>Verify that jacket lumbar plate is engaged in the slot at bottom of S1, and that M6 screws are tight.</p> <p>Refer to App.1/Dwg.004</p>	
	<p>Setup the spine by carefully following the setup procedure.</p> <p>Refer to paragraph 1.5.5.</p>	

		
	<p>Verify that the lateral tilt of the occipital condyle plate is adjusted to zero +/- 0.2 degrees relative to the lumbar plate, when adjusting the damper cable tension. Verify that this adjustment was the final cable adjustment.</p> <p>Refer to paragraph 1.5.</p>	
	<p>Inspect the jacket for any tears. Minor repairs can be accomplished with room-temperature vulcanising silicone. For major tears the jacket should be replaced.</p>	
	<p>Verify the abdomen contains the correct amount of water, which is 2.06 litres/2.06 kg. The weight of the jacket, pins, and water is 21.87 +/- 0.30 kg.</p> <p>Refer to App.5/Dwg.021</p>	
 <p>NOTE: ALL DIMENSIONS IN MILLIMETERS</p>		

Item	Qty	Dwg. No.	Description
1	1	App.5/Dwg.021	Torso Jacket assy.
2	4	App.5/Dwg.012	Spine, Torso interface pin assy.
3	2	App.5/Dwg.010	Spine, Torso interface pin assy.
4	2	App.5/Dwg.011	Spine, Torso interface pin assy.
5	1	App.5/Dwg.008	Spine, Torso interface pin assy.
6	6	App.5/Dwg.014	Spine, Torso interface pin assy.
7	4	App.5/Dwg.013	Spine, Torso interface pin assy.
8	1	App.5/Dwg.009	Spine, Torso interface pin assy.

	<p>Verify the screws at the base of the spine are tightened after reinstalling jacket onto the spine.</p> <p>Refer to App.1/Dwg.005 and to paragraph 1.3.</p>
	<p>Prior to the head being installed, check the tilt sensor mount to ensure it will not touch the cable adjuster. Contact causes a load path around the load cell and produces incorrect load cell readings during test.</p> <p>The picture to the left shows an incorrect mount which is touching the cable adjuster.</p>
	<p>Verify the screws at the base of the spine are tightened after reinstalling the spine into the pelvis.</p> <p>Refer to App.1/Dwg.004</p>
	<p>Verify that there is no lateral play in the neck.</p> <p>Refer to paragraph 1.5.4.</p>
	<p>Verify the Teflon pad behind the dummy is installed correctly and in the correct position, with the Teflon against the vertebrae.</p> <p>Refer to App.1/Dwg.004</p>

	<p>Verify that the spine adjustment is balanced so that it can hold the head at +4 degrees and -4 degrees on the certification sled.</p>	
	<p>Store the dummy with the pelvis and jacket supported in a slightly reclined position.</p> <p>Refer to paragraph 4.1.</p>	
	<p>Check jacket stiffness annually with a dynamic impact test</p> <p>Refer to the jacket certification procedures in Annex 3, paragraph 4.</p>	
	<p>To avoid damage during transport and storage the neck should be supported. The image shows an example of a bracket arrangement for this purpose.</p>	
	<p>Verify that the instrumentation cable strain reliefs have loops as identified in paragraph 2.5.3.</p>	

		
	<p>Verify that the femur plungers are set to 1-2 g. Refer to paragraph 1.10.2</p>	
	<p>Verify that all arm and leg joints are set at 1-2 g. Refer to paragraph 1.10.2</p>	

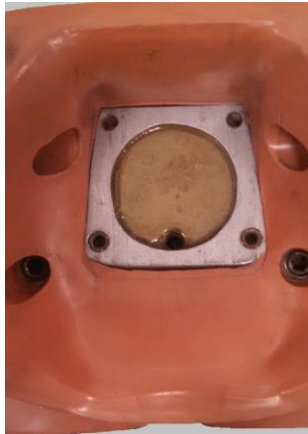
		
	<p>Verify that the pelvis flesh is not pulling away from the front of the bone, if the flesh is pulling away, it is possible for the bone to rotate with in the flesh. The picture shows a normal, serviceable pelvis.</p>	

	<p>Ensure that the shirts and shorts are of the correct material and that two of each are fitted.</p> <p>When fitting, ensure that the shiny sides of the materials come face to face with each other.</p>	
--	--	--

..."
