



---

**Economic Commission for Europe****Inland Transport Committee****World Forum for Harmonization of Vehicle Regulations****Working Party on Lighting and Light-Signalling****Eighty-fifth session**

Geneva, 26-29 October 2021

Item 4 (c) of the provisional agenda

**Simplification of lighting and light-signalling UN Regulations:****UN Regulation No. 149 (Road illumination devices)****Proposal for a new series 01 of amendments to UN  
Regulation No. 149 on Road Illumination Devices (RID)****Submitted by the Informal Working Group on Simplification of  
Lighting and Light-Signalling Regulations\***

The text reproduced below was prepared by the Informal Working Group on Simplification of Lighting and Light-Signalling Regulations (IWG SLR) with the purpose of introducing a completely new text as the 01 series of amendments to UN Regulation No. 149.

This proposal is based on the original text of UN Regulation No. 149 (ECE/TRANS/WP.29/2018/158/Rev.1) and takes into account the subsequent Supplements (ECE/TRANS/WP.29/2019/82, ECE/TRANS/WP.29/2019/125, ECE/TRANS/WP.29/2020/33 and ECE/TRANS/WP.29/2021/46).

In order to improve the readability of the document, this proposal is presented as “clean” text (see also the justification). A presentation of the main changes is available as informal document GRE-85-04.

---

\* In accordance with the programme of work of the Inland Transport Committee for 2021 as outlined in proposed programme budget for 2021 (A/75/6 (Sect.20), para 20.51), the World Forum will develop, harmonize and update UN Regulations in order to enhance the performance of vehicles. The present document is submitted in conformity with that mandate.

## I. Proposal

*UN Regulation No. 149*, amend to read:

### **"UN Regulation on uniform provisions concerning the approval of road illumination devices (lamps) and systems for power-driven vehicles**

#### Contents

*Page*

#### Regulation

1. Scope .....	4
2. Definitions.....	4
3. Administrative Provisions .....	5
4. General Technical Requirements .....	14
5. Specific Technical Requirements .....	21
6. Conformity of Production .....	36
7. Transitional Provisions .....	46

#### Annexes

1 Communication.....	48
2 Minimum requirements for conformity of production control procedures.....	54
3 Minimum requirements for sampling by an inspector.....	56
4 Spherical coordinate measuring system and test point locations.....	58
5 Visual aiming method of Road Illumination Devices. Definition of "cut-off" line for passing-beam headlamps and front fog lamps.....	69
6 Instrumental aiming method for a device providing a passing-beam or a front fog lamp and requirements for "cut-off" line .....	73
7 Tests for stability of photometric performance of Road Illumination Devices in operation (except cornering lamps).....	78
Appendix 1 - Overview of operational periods concerning test for stability of photometric performance.....	84
Appendix 2 - Test mixture for dirty headlamp test.....	85
8 Requirements for road illumination devices (except cornering lamps) incorporating lenses of plastic material testing of lens or material samples .....	86
Appendix 1 - Chronological order of material tests .....	92
Appendix 2 - Method of measurement of the diffusion and transmission of light .....	93
Appendix 3 - Spray testing method .....	95
Appendix 4 - Adhesive tape adherence test.....	96
9 Requirements for LED modules.....	97
10 Testing procedures with respect to light sources.....	100
11 Centre of reference.....	102
12 Voltage markings .....	103

13	Arrangement of approval markings.....	104
14	Description forms.....	108

## Introduction (for information)

This Regulation combines the provisions of the individual UN Regulations Nos. 19, 98, 112, 113, 119 and 123 into a single regulation, and is the outcome of the WP.29 decision to simplify the UN lighting and light-signalling regulations based on the initial proposal by the European Union and Japan.

The objective of this Regulation is to increase the clarity, consolidate and streamline the complexity of requirements in UN Regulations Nos. 19, 98, 112, 113, 119 and 123 and prepare for the future transition to performance-based requirements, by reducing the number of regulations through an editorial exercise without changing any of the detailed technical requirements already in force up to the date of entry into force of this Regulation. This is reflected by the introduction of the original series of amendments to UN Regulation No. 149 and completes one of the objectives of the Working Party on Lighting and Light-Signalling (GRE) Informal Working Group "Simplification of Lighting and Light-Signalling Regulations" (IWG SLR).

With the introduction of the 01 series of amendments to this Regulation another objective of GRE IWG SLR comes into existence. This new series of amendments deals with the identified amendments and clarifications to this Regulation in order to achieve, to the current maximum possible extent, the goal of being technologically neutral, performance based and able to be tested objectively. This is accompanied by amendments to UN Regulations regarding the installation of lighting and light-signalling devices (Nos. 48, 53, 74 and 86) to reflect any necessary changes influenced by this Regulation.

### 1. Scope

This Regulation applies to the following road illumination devices (lamps):

- Headlamps emitting a driving-beam and/or an asymmetrical passing-beam for vehicles of categories L, M, N and T
- Adaptive front-lighting systems (AFS) for vehicles of categories M and N
- Headlamps emitting a driving-beam and/or a symmetrical passing-beam for vehicles of categories L and T
- Front fog lamps for vehicles of categories L<sub>3</sub>, L<sub>4</sub>, L<sub>5</sub>, L<sub>7</sub>, M, N and T
- Cornering lamps for vehicles of categories M, N and T

### 2. Definitions

For the purposes of this Regulation:

- 2.1. The definitions given in the latest series of amendments to UN Regulations Nos. 48 in force at the time of application for type approval shall apply, unless otherwise specified in this Regulation or in the pertinent installation UN Regulations Nos. 53, 74 and 86.
- 2.2. "*Road illumination devices (lamps) of different types*" means road illumination devices which differ in such essential respects as:
  - 2.2.1. The trade name or mark:
    - (a) Road illumination devices (lamps) bearing the same trade name or mark but produced by different manufacturers shall be considered as being of different types;
    - (b) Road illumination devices (lamps) produced by the same manufacturer differing only by the trade name or mark shall be considered as being of the same type;
  - 2.2.2. The characteristics of the optical system;

- 2.2.3. The inclusion or elimination of components capable of altering the optical effects by reflection, refraction, absorption and/or deformation during operation;
- 2.2.4. The suitability for right-hand or left-hand traffic or for both traffic systems;
- 2.2.5. For headlamps: the kind of beam produced (passing-beam, driving-beam or both);
- 2.2.6. For AFS: the front-lighting function(s) produced (passing-beam, driving-beam and adaptive main-beam); the change of mode(s) and/or class(es) does not constitute a change of type;
- 2.2.7. The category of light source(s) used and/or the light source module specific identification code(s); the use of LED substitute light source(s) does not constitute a change of type, however, paragraph 4.6.1. applies;
- 2.2.8. However, a device intended for the installation on the left side of the vehicle and the corresponding device intended for the installation on the right side of the vehicle shall be considered to be of the same type.
- 2.3. “*Main mode*” means:
- in case of a headlamp: principal passing-beam if present, otherwise front fog lamp if present, otherwise driving-beam;
  - in case of AFS: passing-beam mode which draws the highest total wattage.

### 3. Administrative provisions

- 3.1. Application for approval
- 3.1.1. The application for type approval shall be submitted by the holder of the trade name or mark or by his duly accredited representative.
- 3.1.2. The application shall be accompanied by the following documents (in triplicate) and sample(s):
- 3.1.2.1. drawings, sufficiently detailed to permit identification of the type and, if applicable, of the class of the lamp, showing:
- (a) Geometrically in what position(s) the lamp(s) and/or the lighting units may be mounted on the vehicle in relation to ground and vehicle longitudinal median plane;
  - (b) The axis of observation to be taken as the axis of reference in the tests (horizontal angle  $H = 0^\circ$ , vertical angle  $V = 0^\circ$ ) or in the case of lighting units showing each of them in vertical (axial) section and in front elevation, with main details of the optical design including the axis/axes of reference; and the point to be taken as the centre of reference during the tests;
  - (c) The limit of the apparent surface of the function(s);
  - (d) The space reserved and the arrangement intended for the approval marking or the Unique Identifier;
  - (e) In case of replaceable light source module(s), the module(s) and the space reserved for the specific identification code(s) of the module(s) on the lamp and on the module(s);
  - (f) A frontal view, with details of lens ribbing if any, and the cross section and any optical features, of the lens, if applicable;
- 3.1.2.2. A brief technical description stating in particular:
- (a) In the case of lamps with replaceable UN approved light sources, the category or categories of light source(s) prescribed;

- (b) In the case of lamps with replaceable light source modules, the light source module specific identification code;
  - (c) The make and type of electronic light source control gear(s), if any and if not being part of an installation unit;
  - (d) In the case the lamp shall also be approved with the LED substitute light source(s) according to UN Regulation No. 128, the category or categories of light source(s) prescribed;
  - (e) If the device (lamp) is equipped with an adjustable reflector, the mounting position(s) of the lamp in relation to the ground and the longitudinal median plane of the vehicle;
- 3.1.2.2.1. In the case of a headlamp, it shall specify:
- (a) Whether the headlamp is intended to provide both a passing-beam and a driving-beam or only one of these beams;
  - (b) If the headlamp is intended to provide a passing-beam, whether it is designed for both left-hand and right-hand traffic or for either left-hand or right-hand traffic only;
  - (c) To which Class(es) (passing-beam and/or driving-beam) the headlamp belongs;
  - (d) In the case of light source module(s) this shall include:
    - (i) A brief technical specification of the light source module(s);
    - (ii) A drawing with dimensions and the basic electrical and photometric values and the objective luminous flux and for each light source module a statement whether it is replaceable or not;
    - (iii) In case of electronic light source control gear, information on the electrical interface necessary for approval testing;
  - (e) Whether the left and the right headlamps are operating as matched pair;
- 3.1.2.2.2. In the case of an AFS, it shall specify:
- (a) The lighting function(s) and their modes to be provided by the system;<sup>1</sup>
  - (b) The lighting units contributing to each of them and the signals<sup>2</sup> with the technical characteristics relevant to their operation;
  - (c) Which categories of the bending mode requirements apply, if any;
  - (d) Which additional data set(s) of Class E passing-beam provisions according to Table 12, if any;
  - (e) Which set(s) of Class W passing-beam provisions according to paragraph 5.3.2., if any;
  - (f) Which lighting units<sup>2</sup> provide or contribute to one or more passing-beam cut-off(s);
  - (g) The indication(s)<sup>2</sup> according to the provisions of paragraph 5.3.5.1. with respect to paragraph 6.22. of UN Regulation No. 48;
  - (h) Which lighting units are designed to provide the minimum passing-beam illumination according to paragraph 5.3.2.8.1.;
  - (i) Mounting and operation requirements for test purposes;
  - (j) Any other relevant information;

---

<sup>1</sup> To be indicated in a form conforming to the model of Annex 1.

<sup>2</sup> To be indicated in a form conforming to the model of Annex 14.

- (k) In the case of light source module(s) this shall include, for each module:
    - (i) A brief technical specification of the light source module(s);
    - (ii) A drawing with dimensions and the basic electrical and photometric values and the objective luminous flux and for each light source module a statement whether it is replaceable or not;
    - (iii) In case of electronic light source control gear, information on the electrical interface necessary for approval testing;
  - (l) Any other front-lighting or front light signalling function(s), provided by any lamp(s) being grouped, combined or reciprocally incorporated to the lighting units of the system, for which approval is sought; sufficient information for identification of the respective lamp(s) and indication of the Regulation(s), according to which they are intended to be (separately) approved;
- 3.1.2.2.3. In the case of adaptation of the driving-beam, which lighting units<sup>2</sup> provide or contribute to the gradual adaptation of the driving-beam and of the sensor system along with the technical characteristics relevant to their operation.
- 3.1.2.2.3.1. The safety concept as laid down in the documentation, which, to the satisfaction of the Technical Service responsible for type approval tests:
- (a) Describe the measures designed into the system to ensure compliance with the provisions of paragraphs 4.11.1.2. and 5.3.2.5.4.; and
  - (b) Indicates the instructions for their verification according to paragraph 5.3.2.6.; and/or
  - (c) Gives access to the relevant documents demonstrating the system's performance concerning sufficient reliability and safe operation of the measures specified according to paragraph 3.1.2.2.3.1. a), e.g. FMEA ("Failure Mode and Effect Analysis"), FTA ("Fault Tree Analysis") or any similar process appropriate to system safety considerations.
- 3.1.2.3. If not otherwise specified, two complete samples, one sample intended for the installation on the left side of the vehicle and one sample intended for the installation of the right side of the vehicle.
- 3.1.2.4. For all lamps with plastic outer lenses, except for cornering lamps, samples of the plastic material of which the lenses are made (see Annex 8).
- 3.1.2.5. In the case of an AFS System, one set of samples of the system, for which approval is sought, including the mounting devices, supply and operating devices, and signal generators if any;
- 3.1.2.6. In the case of a type of lamp differing only by the trade name or mark from a type that has already been approved it is sufficient that the application is accompanied by:
- 3.1.2.6.1. A declaration by the lamp manufacturer that the type submitted is identical (except in the trade name or mark) with and has been produced by the same manufacturer as the type already approved, the latter being identified by its approval number;
  - 3.1.2.6.2. Two samples bearing the new trade name or mark or equivalent documentation.
- 3.1.3. In the case of cornering lamps equipped with non-replaceable filament light source(s) or light source module(s) equipped with non-replaceable filament light source(s), the applicant shall annex to the type approval documentation a report according to paragraph 4.5.2.5..
- 3.2. Approval
- A separate approval is required for each lamp (function) listed in Table 1.

When two or more lamps are part of the same assembly of grouped, combined or reciprocally incorporated lamps, approval is granted only if each of these lamps satisfies the requirements of this Regulation or of another Regulation. Lamps not satisfying any one of those Regulations shall not be part of such an assembly of grouped, combined or reciprocally incorporated lamps.

- 3.2.1. If the devices submitted for approval in pursuance of paragraph 3.1. meet the requirements of this Regulation approval shall be granted.
- 3.2.2. An approval number shall be assigned to each type approved and shall be marked on the device following the requirements of paragraph 3.3.. The same Contracting Party shall not assign the same number to another type of device covered by this Regulation.
- 3.2.3. Notice of approval or of extension or refusal or withdrawal of approval of a type of a device pursuant to this Regulation shall be communicated to the Contracting Parties to the 1958 Agreement which apply this Regulation, by means of a form conforming to the model in Annex 1.
- 3.2.4. If approval is sought for an AFS which is not intended to be included as part of the approval of a vehicle type according to UN Regulation No. 48,
- 3.2.4.1. The applicant shall submit sufficient documentation to prove the capability of the system to comply with the provisions of paragraph 6.22. of UN Regulation No. 48 when correctly installed, and
- 3.2.4.2. The system shall be approved according to UN Regulation No. 10.
- 3.2.5. The symbols identifying the road illumination function for which type approval has been granted.

Table 1  
**List of symbols/combinations**

<i>Lamp (function)</i>	<i>Symbol</i>	<i>Symbol if device is part of a matched pair</i>
Driving-beam headlamp of Class A	R	YR
Passing-beam headlamp of Class V (asymmetrical)	V	YV
Driving-beam headlamp of Class B	HR	YHR
Passing-beam headlamp of Class C (asymmetrical)	C	YC
Auxiliary Driving-Beam of Class RA	RA	-
Adaptive Front lighting System (Class AFS-C): basic passing-beam	XC <sup>3</sup>	-
Adaptive Front lighting System (Class AFS-E): motorway passing-beam	XCE <sup>3, 4</sup>	-
Adaptive Front lighting System (Class AFS-V): town passing-beam	XCV <sup>3, 4</sup>	-
Adaptive Front lighting System (Class AFS-W): adverse weather passing-beam	XCW <sup>3, 4</sup>	-
Adaptive Front lighting System (Class AFS-R): driving-beam	XR <sup>3</sup>	-
Passing-beam headlamp of Class AS (symmetrical)	C-AS	YC-AS
Passing-beam headlamp of Class BS (symmetrical)	C-BS	YC-BS

<sup>3</sup> In the case of a single installation unit the symbol "XC" is marked only once.

<sup>4</sup> In the case of more installation units each providing one or more AFS function(s) each unit is marked with the symbol "X" followed by the identification symbol(s) of the specific AFS function(s) provided.



<i>Lamp (function)</i>	<i>Symbol</i>	<i>Symbol if device is part of a matched pair</i>
Passing-beam headlamp of Class CS (symmetrical)	WC-CS	YC-CS*
Passing-beam headlamp of Class DS (symmetrical)	WC-DS	YC-DS*
Driving-beam headlamp of Class BS	R-BS	YR-BS*
Secondary driving-beam headlamp of Class CS	WR-CS	YR-CS*
Secondary driving-beam headlamp of Class DS	WR-DS	YR-DS*
Adaptive driving-beam for vehicles of category L3	ADB	YADB
Front fog lamp of Class F3	F3	YF3
Cornering lamp of Class K	K	-

\* The symbol "W" is not indicated because deemed unnecessary for these classes as part of a matched pair

- 3.2.6. The applicable change indexes for each device relating to the series of amendments shall be as follows (see also paragraph 6.1.1.):

Table 2  
Series of amendments and change index

<i>Series of amendments to the Regulation</i>	<i>00</i>	<i>01</i>	
<i>Lamp (Function)</i>	<i>Change Index for the specific Lamp (Function)</i>		
Driving-beam headlamp of Class A	0	1	
Passing-beam headlamp of Class A (asymmetrical)	0	-	
Passing-beam headlamp of Class V (asymmetrical)	-	0	
Driving-beam headlamp of Class B	0	1	
Passing-beam headlamp of Class B (asymmetrical)	0	-	
Passing-beam headlamp of Class C (asymmetrical)	-	0	
Auxiliary driving-beam of Class RA	-	0	
Adaptive driving-beam	0	1	
Adaptive driving-beam for vehicles of category L3	-	0	
Driving-beam headlamp of Class D (GDL)	0	-	
Passing beam headlamp of Class D (GDL)	0	-	
Adaptive Front lighting System (Class AFS-C): basic passing-beam	0	1	
Adaptive Front lighting System (Class AFS-E): motorway passing-beam	0	1	
Adaptive Front lighting System (Class AFS-V): town passing-beam	0	1	
Adaptive Front lighting System (Class AFS-W): adverse weather passing-beam	0	1	
Adaptive Front lighting System (Class AFS-R): driving-beam	0	1	
Passing-beam headlamp of Class AS (symmetrical)	0	1	

<i>Series of amendments to the Regulation</i>	<i>00</i>	<i>01</i>	
<i>Lamp (Function)</i>	<i>Change Index for the specific Lamp (Function)</i>		
Passing-beam headlamp of Class BS (symmetrical)	0	1	
Passing-beam headlamp of Class CS (symmetrical)	0	1	
Passing-beam headlamp of Class DS (symmetrical)	0	1	
Passing-beam headlamp of Class ES (symmetrical)	0	-	
Driving-beam headlamp of Class BS	0	1	
Secondary driving-beam headlamp of Class CS	0	1	
Secondary driving-beam headlamp of Class DS	0	1	
Driving-beam headlamp of Class ES	0	-	
Front fog lamp of Class F3	0	1	
Cornering lamp of Class K	0	1	

Notes to Table 2:

A dash “-” means that this lamp (function) is not available for type approvals according to the corresponding series of amendments.

- 3.3. Approval marking and other markings
- 3.3.1. General provisions
- 3.3.1.1. Every device belonging to an approved type shall comprise a space of sufficient size for the Unique Identifier as referred to in the 1958 Agreement and other markings as defined in paragraph 3.3.4. or the approval marking and other markings as defined in paragraph 3.3.4..
- 3.3.1.1.1. All markings shall be clearly legible and indelible.
- 3.3.1.2. Examples of the arrangement of the markings are shown in Annex 13.
- 3.3.1.2.1. The value for “a” in part 1 of Annex 13 shall be at least 5 mm on plastic material and at least 8 mm on glass.
- 3.3.2. The approval marking shall consist of:
- 3.3.2.1. The approval mark, i.e. a circle surrounding the letter "E" followed by the distinguishing number of the country which has granted approval.<sup>5</sup>
- 3.3.2.2. The four to six-digit sequential number being part of the approval number prescribed in paragraph 3.2.2.
- 3.3.2.3. The number of this Regulation followed by the letter 'R' and the two digits indicating the series of amendments in force at the time of issue of the approval.
- 3.3.2.4. Symbol(s), according to Table 1, and, if applicable, the following additional symbol(s):
- 3.3.2.4.1. In the case of headlamps/AFS installation unit meeting left-hand traffic requirements only, a horizontal arrow pointing to the right of an observer facing the headlamp, i.e. to the side of the road on which the traffic moves;
- 3.3.2.4.2. In the case of headlamps/AFS installation unit designed to meet the requirements of both traffic systems by means of an appropriate adjustment of the setting of the optical unit or the light source(s) or light source module(s), a

<sup>5</sup> The distinguishing numbers of the Contracting Parties to the 1958 Agreement are reproduced in Annex 3 to the Consolidated Resolution on the Construction of Vehicles (R.E.3) (ECE/TRANS/WP.29/78/Rev.6).

horizontal arrow with a head on each end, the heads pointing respectively to the left and to the right;

- 3.3.2.4.3. Front fog lamps of Class F3 having asymmetric light distribution and which must not be indiscriminately mounted on either side of the vehicle, shall bear an arrow pointing to the outside of the vehicle;
- 3.3.2.4.4. In the case of road illumination devices incorporating an outer lens of plastic material, the group of letters "PL" to be affixed near the symbols identifying the function(s);
- 3.3.2.4.5. In the case of headlamps/AFS installation unit meeting the requirements of the driving-beam, an indication, placed near the circle surrounding the letter "E", of the maximum luminous intensity expressed by a reference mark ( $I_M$ ), as defined in paragraph 5.1.4.2.
- In the case of grouped or reciprocally incorporated driving-beam headlamps/AFS lighting unit, indication of the maximum luminous intensity of the driving-beams as a whole shall be expressed as above.
- 3.3.2.4.6. In the case of AFS, a score above the letter(s) indicates that the AFS function(s) is(are) provided by more than one installation unit on that side of the system.
- 3.3.2.4.7. In the case of AFS, in addition the symbol "T", after the symbol(s) of all lighting function(s) and/or class(es) designed to comply with the respective bend lighting provisions, with said symbol(s) arranged together and leftmost to the symbol "T".
- 3.3.2.5. The approval number, the symbols and the additional symbols shall be placed close to the circle and either above or below the letter "E", or to the right or left of that letter. The digits of the approval number shall be on the same side of the letter "E" and face the same direction.
- 3.3.3. Unique Identifier (UI)
- 3.3.3.1. The approval marking as defined in paragraph 3.3.2. may be replaced by the Unique Identifier, if available. The Unique Identifier mark shall follow the format in the example shown below:

Figure I

**Unique Identifier (UI)**

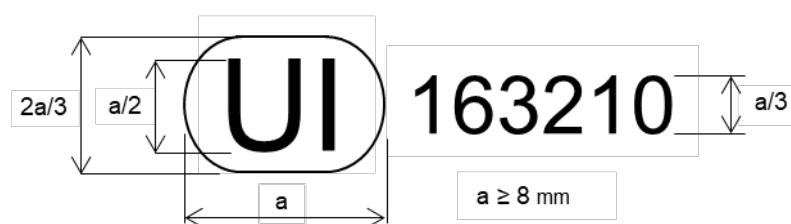

The above Unique Identifier marked on the lamp shows that the type concerned has been approved and that the relevant information on that type approval can be accessed on the UN secure internet database by using 163210 as the Unique Identifier.

- 3.3.4. Marking requirements
- Road illumination functions or systems shall bear the approval marking or the Unique Identifier, the trade name or mark of the applicant and the following markings:
- 3.3.4.1. In the case of devices including a passing-beam designed to satisfy the requirements both of right-hand and of left-hand traffic, markings indicating the two settings of the optical unit on the vehicle or of the light source on the

reflector; these markings shall consist of the letters "R/D" for the position for right-hand traffic and the letters "L/G" for the position for left-hand traffic;

3.3.4.2. In the case of lamps with replaceable UN approved light source(s) or with replaceable light source modules, a marking indicating:

- (a) The category or categories of light source(s) prescribed; in the case where lamps have been approved for LED substitute light source(s), also the category or categories of the LED substitute light source(s); and/or
- (b) The specific identification code(s) of light source module(s) and
- (c) The rated voltage(s) (i.e. 6V, 12V or 24V) or the range of voltage.

3.3.4.3. In the case of lamps with non-replaceable light source modules a marking indicating the rated voltage(s) or the range of voltage;

3.3.4.4. In the case of lamps with light source module(s), a marking on the light source module(s) indicating:

- (a) The trade name or mark of the applicant;
- (b) The specific identification code of the module. This specific identification code shall comprise the starting letters "MD" for "MODULE" followed by the markings as described in paragraphs 3.3.2.1. (without the circle) and 3.3.2.2. and, in case several non-identical light source modules are used, followed by additional symbols or characters. This identification code shall be shown in the drawings mentioned in paragraph 3.1.2.1..

The approval mark does not have to be the same as the one on the lamp in which the module is used, but both marks shall be from the same applicant;

- (c) The rated voltage or the range of voltage.

In the case where the light-source module(s) is non-replaceable, it does not need to be marked;

3.3.4.5. In the case an electronic light source control gear, which is part of the lamp but not included into the lamp body, is used to operate a light source or a light source module(s), it shall be marked with its specific identification code and the rated input voltage or range of voltage;

3.3.4.6. In the case of AFS, front fog lamps and headlamps except Class AS, BS, CS, and DS meeting the requirements of Annex 7 only when supplied with a voltage of 12V, a marking consisting of the Number 24 crossed out by an oblique cross (X) near the holders of the light source(s) as shown in Annex 12;

3.3.4.7. In the case of a headlamp having additional lighting unit(s) for vehicles of categories L and T:

3.3.4.7.1. The headlamps producing the principal passing-beam shall bear specific identification code of the additional lighting unit(s) mentioned in paragraph 3.3.4.7.2.2.

3.3.4.7.2. Additional lighting unit(s) shall bear the trade name or mark of the applicant and the following markings:

3.3.4.7.2.1. In the case of light source(s), their category(ies); in the case where the lamp has been approved for the use of LED substitute light source(s) in the additional lighting unit(s), also the category or categories of the LED substitute light source(s); and/or

In the case of light source module(s), the rated voltage and rated wattage and the specific identification code(s) of the light source module(s).

- 3.3.4.7.2.2. The specific identification code(s) of the additional lighting unit(s). This marking shall be clearly legible and indelible.
- This specific identification code shall be comprised of starting letters "ALU" for "Additional Lighting Unit" followed by approval marking without the circle and in the case where several non-identical additional lighting units are used, additional symbols or characters shall follow. This specific identification code shall be shown in the drawings. The approval marking does not have to be the same as the one on the lamp in which the additional lighting unit(s) is used, but both markings shall be from the same applicant.
- 3.3.4.8. Road Illumination Devices may bear on their light-emitting surface a centre of reference as shown in Annex 11.
- 3.3.5. Marking location
- 3.3.5.1. The Unique Identifier or the approval marking shall be placed on an inner or outer part (transparent or not) of the lamp.
- 3.3.5.2. In any case, the Unique Identifier or the approval marking as well as the category or categories of LED substitute light source(s) prescribed, if any, shall be visible when the lamp is fitted on the vehicle or when a movable part such as the hood or boot lid or a door is opened.
- 3.3.5.3. If the outer lens of a device is designed to be separated from the main body, the Unique Identifier or the approval marking shall be placed on both, the detachable lens and the main body.
- 3.3.5.4. In case an outer lens is used for several devices and bearing different approval markings, the main body of each device shall bear only the approval marking of the function(s) of that device.
- 3.3.6. Grouped, combined or reciprocally incorporated lamps
- 3.3.6.1. In the case of grouped, combined or reciprocally incorporated lamps a single Unique Identifier or approval mark may be applied, provided that all the grouped, combined or reciprocally incorporated lamps satisfy the pertinent Regulation and that the following requirements are also fulfilled:
- (a) Requirements of paragraph 3.3.2. apply;
  - (b) No part of the grouped, combined or reciprocally incorporated lamps that transmits light can be removed without at the same time removing the approval mark;
  - (c) The symbols for each lamp, appropriate to each UN Regulation under which approval has been granted, shall be marked:
    - (i) Either on the appropriate light-emitting surface;
    - (ii) Or in a group, in such a way that each lamp of the grouped, combined or reciprocally incorporated lamps may be clearly identified.
- 3.4. Modifications of a road illumination device and extension of approval
- 3.4.1. Every modification of a type of lamp shall be notified to the Type Approval Authority which approved the type. The Authority may then either:
- 3.4.1.1. Consider that the modifications made are unlikely to have an appreciable adverse effect and that in any case the lamp still complies with the requirements; or
- 3.4.1.2. Require a further test report from the technical service responsible for conducting the tests.
- 3.4.2. Confirmation or refusal of approval, specifying the alterations, shall be communicated by the procedure specified in paragraph 3.2.3. to the Contracting Parties to the 1958 Agreement applying this Regulation.

- 3.4.3. The Type Approval Authority issuing the extension of approval shall assign a series number for such an extension and inform thereof the other Contracting Parties to the 1958 Agreement applying this Regulation under which the approval has been granted by means of a communication form conforming to the model in Annex 1 to this Regulation.
- 3.5. Conformity of production procedures  
The conformity of production procedures shall comply with those set out in the 1958 Agreement, Schedule 1 (E/ECE/TRANS/505/Rev.3), with the requirements set forth in paragraph 6.
- 3.6. Penalties for non-conformity of production
- 3.6.1. The approval granted in respect of a device pursuant to this Regulation may be withdrawn if the foregoing requirements are not met;
- 3.6.2. If a Contracting Party to the Agreement which applies this Regulation withdraws an approval it has previously granted, it shall forthwith so notify the other Contracting Parties applying this Regulation, by means of a communication form conforming to the model in Annex 1.
- 3.7. Production definitively discontinued  
If the holder of the approval completely ceases to manufacture a device approved in accordance with this Regulation, he shall so inform the authority which granted the approval. Upon receiving the relevant communication, that authority shall inform thereof the other Contracting Parties to the 1958 Agreement applying this Regulation by means of a communication form conforming to the model in Annex 1.
- 3.8. Names and addresses of Technical Services responsible for conducting approval tests, and of Type Approval Authorities  
The Contracting Parties to the 1958 Agreement which apply a UN Regulation shall communicate to the United Nations Secretariat the names and addresses of the Technical Services responsible for conducting approval tests and of the Type Approval Authorities which grant approval and to which forms certifying approval or extension or refusal or withdrawal of approval, or the definitive discontinuation of production issued in other countries, are to be sent.

## **4. General Technical Requirements**

Lamps submitted for approval shall conform to the requirements set forth in paragraphs 4 and 5.

The requirements contained in sections 5 "General specifications" and 6 "Individual specifications" (and in the Annexes referenced in the said sections) of UN Regulations No. 48, 53, 74 or 86, and their series of amendments in force at the time of application for the lamp type approval shall apply to this Regulation.

The requirements pertinent to each lamp and to the category/ies of vehicle on which the lamp is intended to be installed shall be applied, where its verification at the moment of lamp type approval is feasible.

- 4.1. The lamps must be so designed and constructed that under normal conditions of use and notwithstanding the vibrations to which they may be subjected in such use, their satisfactory operation remains assured and they retain the characteristics prescribed by this Regulation.
- 4.2. Lamps shall be so made that they give adequate illumination without dazzle when emitting the passing-beam, and good illumination when emitting the driving-beam.

- 4.3. Lamps shall be fitted with a device enabling them to be so adjusted on the vehicles as to comply with the rules applicable to them. Such a device need not be fitted on units in which the reflector and the diffusing lens cannot be separated, provided the use of such units is confined to vehicles on which the lamp setting can be adjusted by other means.
- 4.3.1. In case of headlamps of classes AS, BS, CS, DS and of front fog lamps, such a device may or may not provide horizontal adjustment, provided that the headlamps are so designed that they can maintain a proper horizontal aiming even after the vertical aiming adjustment.
- 4.3.2. In case of cornering lamps, such a device is not required.
- 4.4. Where a lamp producing a principal passing-beam and a lamp producing a driving-beam, each equipped with its own light source(s) or light source module(s), are assembled to form one unit, the adjusting device shall enable the principal passing-beam and the driving-beam to be adjusted individually.
- However, these provisions shall not apply to assemblies whose optical units are indivisible.
- 4.5. Provisions with regard to light sources
- 4.5.1. Use of light sources
- The lamp shall only be equipped with:
- replaceable light source(s) approved according to UN Regulations Nos. 37, 99 and/or 128, provided that no restriction on the use is made at the time of application for type approval, and/or
  - light source module(s) and/or
  - non-replaceable light source(s).
- 4.5.2. General requirements with regard to light sources
- 4.5.2.1. In case a light source category or categories or type(s) is restricted for use in lamps on vehicles in use and originally equipped with such lamps, the applicant for type approval of the lamp shall declare that the lamp is only intended for installation on those vehicles; this shall be noted in the communication form
- 4.5.2.2. In case of replaceable UN approved light source(s),
- (a) The design of the lamp shall be such that the light source(s) can be fixed in no other position but the correct one;
  - (b) The light source(s) holder shall conform to the characteristics given in IEC Publication 60061. The holder data sheet relevant to the category of light source(s) prescribed, applies. In addition, where a category of LED substitute light source(s) is also prescribed, the holder data sheet relevant to the category of LED substitute light source(s) applies.
- 4.5.2.3. Road illumination devices shall not generate radiated or power line disturbances, which cause a malfunction of other electric/electronic systems of the vehicle.<sup>6</sup>
- 4.5.2.4. In case of replaceable light source module(s), the design of the light source module(s) shall be such that
- (a) it can only be fitted in the designated and correct position and can only be removed with the use of tool(s); and
  - (b) it is tamperproof; and

<sup>6</sup> Compliance with the requirements for electromagnetic compatibility is relevant to the vehicle type.

- (c) regardless of the use of tool(s), it is not mechanically interchangeable with:
- any replaceable UN approved light source; and/or,
  - any other replaceable light source module having different characteristics that is located in the same lamp housing.
- (d) when the light source module is removed and replaced by another module provided by the applicant and bearing the same light source module identification code, the photometric requirements of the lamp or AFS system shall be met.
- 4.5.2.4.1. If applicable, light source modules shall comply with the requirements specified in Annex 9.
- 4.5.2.5. In the case of cornering lamps equipped with non-replaceable filament light source(s) or light source module(s) equipped with non-replaceable filament light source(s), the applicant shall annex to the type approval documentation a report, acceptable to the Authority responsible for type approval, that demonstrates compliance of these non-replaceable filament light source(s) with the requirements as specified in paragraph 4.11 of IEC 60809, Edition 3.
- 4.5.3. Specific requirements with regard to light sources
- 4.5.3.1. The luminous flux of the light source(s), or the luminous flux of the principal passing-beam, shall be determined according to the provisions in paragraph 4.6..
- 4.5.3.2. In case of the principal passing-beam either:
- (a) the total objective luminous flux of all light sources (UN approved light sources, light source modules and non-replaceable light sources) producing the principle passing-beam shall be equal or greater than the minimum values shown in Table 3a

Table 3a

**Minimum values of the luminous flux of light sources**

<i>Principle passing-beam classes</i>	<i>Minimum luminous flux in lm</i>
V, C, AFS-C, DS	$1.00 \cdot 10^3$
AS	$1.50 \cdot 10^2$
BS	$3.50 \cdot 10^2$
CS	$5.00 \cdot 10^2$

or

- (b) the luminous flux in the principal passing-beam shall meet the requirements in zones I and II, as specified in the Table 3b, when aimed according to paragraphs 3.2. (for classes V, C, AFS-C) and 3.3. (for all the other classes) in Annex 5.

Table 3b

**Minimum values of the luminous flux in the principal passing-beam in Zones I and II**

<i>Beam classes</i>	<i>Zone</i>	<i>Forward field</i>	<i>Minimum luminous flux in field in lm</i>
V, C, AFS-C, DS	I	30°L to 30°R and 15°D to 1°U	$4.00 \cdot 10^2$
	II	30°L to 30°R and 3.5°D to 1°U	$2.00 \cdot 10^2$
AS	I	30°L to 30°R and 15°D to 1°U	$6.0 \cdot 10^1$
	II	30°L to 30°R and 3.5°D to 1°U	$3.0 \cdot 10^1$
BS	I	30°L to 30°R and 15°D to 1°U	$1.40 \cdot 10^2$
	II	30°L to 30°R and 3.5°D to 1°U	$7.0 \cdot 10^1$
CS	I	30°L to 30°R and 15°D to 1°U	$2.00 \cdot 10^2$



	II	30°L to 30°R and 3.5°D to 1°U	1.00·10 <sup>2</sup>
--	----	-------------------------------	----------------------

- 4.5.3.3. In case of the principle passing-beam the total objective luminous flux of all light sources (UN approved light sources, light source modules and non-replaceable light sources) producing the principle passing-beam shall be equal or smaller than the maximum values shown in Table 4, if any.

Table 4

**Maximum values of the luminous flux of light sources**

<i>Principle passing-beam classes</i>	<i>Maximum luminous flux in lm</i>
AS	9.00·10 <sup>2</sup>
BS	1.00·10 <sup>3</sup>
CS	2.00·10 <sup>3</sup>

- 4.5.3.4. Front fog lamps, designed to operate permanently with an additional system to control the intensity of the light emitted, or which are reciprocally incorporated with another function, using a common light source, and designed to operate permanently with an additional system to control the intensity of the light emitted, are permitted.
- 4.5.3.5. Except for AFS and cornering lamps, in case of a lamp incorporating one or more light source(s) or light source module(s) producing the principal passing-beam or the front fog beam and having a total objective luminous flux which exceeds 2.00·10<sup>3</sup> lumens, a reference shall be made in the communication form in Annex 1.
- 4.5.3.6. In case of an AFS incorporating light sources and/or light source module(s) producing the basic passing-beam and having a total objective luminous flux of the lighting units as indicated under item 9.2. 3.(a) of the communication form which exceeds 2.00·10<sup>3</sup> lumen per side, a reference shall be made in the communication form in Annex 1.
- 4.6. Testing conditions and measurement methods
- 4.6.1. General provisions
- All measurements, photometric and colorimetric, shall be made with respect to the following conditions (Particulars of the methods of measurement to be used are given in Annex 4):
- 4.6.1.1. In the case of replaceable UN approved light sources, all measurements shall be made using standard light sources as specified in R.E.5.
- 4.6.1.1.1. Additionally, in the case of replaceable UN approved light source(s) controlled by an electronic light source control gear or variable intensity control, the standard light source(s) shall have a luminous flux value that does not deviate more than 5 per cent from its reference/objective luminous flux value when test voltage is applied.
- 4.6.1.2. In the case of a lamp equipped with light source module(s) or non-replaceable light source(s), all measurements shall be made with the light source(s) present in the lamp.
- 4.6.1.3. In case of a lamp (function) using light sources which are subject to more than one of the conditions prescribed in paragraph 4.6., the photometric measurements may be made separately, in accordance with each applicable condition(s) set forth in paragraph 4.6..
- All separate measurement results, if any, shall be added together.
- The test laboratory may require from the applicant samples allowing to supply the different light source(s) separately.
- 4.6.1.4. During photometric measurements, stray reflections shall be avoided by appropriate masking.

- 4.6.1.5. In the case where a front fog lamp or a cornering lamp may be installed on the vehicle in more than one or in a field of different positions the photometric measurements shall be repeated for each position or for the extreme positions of the field of the reference axis specified by the manufacturer.
- 4.6.1.6. In the case where the lamp shall also be approved with LED substitute light source(s), all measurements, photometric and colorimetric, shall be repeated using the LED substitute light source(s) prescribed.
- 4.6.2. Operation of the lamp for testing
- Unless otherwise specified, the voltage supplied at the lamp shall be either 6.3 V (6 Volt-Systems), 13.2 V (12 Volt-Systems) or 28.0 V (24 Volt-Systems).
- 4.6.2.1. In case of a lamp and/or a light source module controlled by an electronic light source control gear, the lamp shall be operated as specified by the applicant.
- The test laboratory may require from the manufacturer the electronic light source control gear.
- 4.6.2.2. In case of a lamp not controlled by an electronic light source control gear:
- 4.6.2.2.1. in case of light source module(s) or non-replaceable light source(s) the voltage supplied at the input terminals of the lamp shall be operated as specified by the applicant;
- 4.6.2.2.2. in the case of replaceable UN approved light sources the light sources shall be operated at the reference/objective luminous flux or alternatively at a different luminous flux with a proportional correction on the measured luminous intensities.
- 4.6.2.3. In case of lamps equipped with multiple replaceable UN approved light sources:
- 4.6.2.3.1. shall be operated at a voltage or electrical current setting such that the actual luminous fluxes of the light sources do not deviate by more than 5 per cent from the average luminous flux of the light sources. The measured luminous intensities shall be corrected proportionally for the difference between the average luminous flux and the applicable reference/objective luminous flux.
- 4.6.2.3.2. alternatively, can be tested by using one light source in each of the individual lamp holder positions operating at the reference/objective luminous flux and application of the sum of the measured luminous intensities for each direction.
- 4.6.2.4. The identification of an electronic light source control gear if applicable and/or the voltage applied, including the tolerances, shall be noted in the communication form in Annex 1.
- 4.6.3. Tests for compliance of the luminous intensities and colorimetric characteristics shall be carried out according to Annex 10.
- 4.6.3.1. For lamps (functions) using different light source technologies, the colorimetric characteristics shall be checked for each light source technology separately according to the applicable provisions in paragraphs 4.6.1. and 4.6.2.
- The test laboratory may require from the applicant samples allowing to supply the different light source(s) separately.
- 4.7. Testing of light transmitting components made of plastic material (except for cornering lamps and headlamps of classes AS).
- 4.7.1. If the outer lens of the lamp is made of plastic material tests shall be done according to the requirements in Annex 8.

- 4.7.2. The UV resistance of light transmitting components located inside a front fog lamp and made of plastic material shall be tested according to Annex 8, paragraph 3.3.
- 4.7.2.1. The test prescribed in paragraph 4.7.2. is not necessary if low-UV type light sources as specified either in the relevant UN Regulation or in Annex 9 are used, or if provisions are taken, to shield the relevant lamp components from UV radiation, e.g. by glass filters.
- 4.8. The sharpness and linearity of the cut-off, if applicable, shall be tested according to the requirements in Annex 6.
- 4.9. Except for cornering lamps, complementary tests shall be done according to the requirements in Annex 7 to ensure that in use there is no excessive change in photometric performance.
- 4.10. Passing-beam headlamps and AFS with asymmetrical "cut-off" line designed to satisfy the requirements both of right hand and of left-hand traffic may be adapted for traffic on a given side of the road either by an appropriate initial setting when fitted on the vehicle or by selective setting by the user. In all cases, only two different and clearly distinct settings, one for right hand and one for left-hand traffic, shall be possible, and the design shall preclude inadvertent shifting from one setting to the other or setting in an intermediate position.
- Conformity with the requirements of this paragraph shall be verified by visual inspection and, where necessary, by a test fitting.
- 4.11. Testing of mechanical or electromechanical structures
- 4.11.1. On headlamps or AFS designed to provide alternately a driving-beam and a passing-beam, or a passing-beam and/or a driving-beam designed to become bend lighting, any mechanical, electromechanical or other device incorporated in the headlamp and lighting unit(s) for these purposes shall be so constructed that:
- 4.11.1.1. The device is robust enough to withstand 50,000 operations under normal conditions of use. In order to verify compliance with this requirement, the Technical Service responsible for approval tests may:
- (a) Require the applicant to supply the equipment necessary to perform the test;
  - (b) Forego the test if the headlamp presented by the applicant is accompanied by a test report, issued by a Technical Service responsible for approval tests for headlamps of the same construction (assembly), confirming compliance with this requirement.
- 4.11.1.2. Headlamps of classes C and V
- In the case of failure, the luminous intensity above the line H-H shall not exceed the values of a passing-beam according to paragraph 5.2.; in addition, on headlamps designed to provide a passing and/or a driving-beam to become a bend lighting, a minimum luminous intensity of at least  $2.50 \cdot 10^3$  cd. shall be fulfilled in test point 25V (V-V line,  $1.72^\circ$ D).
- 4.11.1.3. Either the principal passing-beam or the driving-beam shall always be obtained without any possibility of the mechanism stopping in between two positions.
- 4.11.2. Headlamps of classes AS, BS, CS and DS
- 4.11.2.1. Except for additional light source(s) and additional lighting unit(s) used to produce bend lighting, in the case of failure it must be possible to obtain automatically a passing-beam or a state with respect to the photometric conditions which yields values not exceeding  $1.20 \cdot 10^3$  cd in Zone 1 and at least  $2.40 \cdot 10^3$  cd at 0.86D-V by such means as e.g. switching off, dimming, aiming downwards, and/or functional substitution;

- 4.11.2.2. Except for additional light source(s) and additional lighting unit(s) used to produce bend lighting, either the passing-beam or the driving-beam shall always be obtained without any possibility of the mechanism stopping in between the two positions.
- 4.11.3. AFS
- 4.11.3.1. Except in the case of adaptation of the driving-beam, either the passing-beam or the driving-beam shall always be obtained, without any possibility of remaining in an intermediate or undefined state; if this is not possible, such a state must be covered by the provisions according to paragraph 4.11.3.2.;
- 4.11.3.2. In the case of failure, it must be possible to obtain automatically a passing-beam or a state with respect to the photometric conditions which yields values not exceeding  $1.30 \cdot 10^3$  cd in the zone III b as defined in paragraph 5.3. and at least  $3.40 \cdot 10^3$  cd in a point of "segment  $I_{max}$ ", by such means as e.g. switching off, dimming, aiming downwards, and/or functional substitution;
- When performing the tests to verify compliance with these requirements, the Technical Service responsible for approval tests shall refer to the instructions supplied by the applicant.
- 4.11.4. The user cannot, with ordinary tools, change the shape or position of the moving parts, or influence the switching device.
- 4.12. Illumination configuration of lamps with asymmetrical "cut-off" line only for different traffic conditions.
- 4.12.1. In the case of lamps designed to meet the requirements of traffic moving on one side of the road (either right or left) only, appropriate measures shall be taken to prevent discomfort to road-users in a country where traffic moves on the side of the road opposite to that of the country for which the headlamp was designed<sup>7</sup>. Such measures may be:
- (a) Occulting a part of the outer lens area;
  - (b) Downward movement of the beam. Horizontal movement is allowed;
  - (c) Any other measure to remove or reduce the asymmetrical part of the beam.
- 4.12.2. Following the application of the measures described in paragraph 4.12.1. the following requirements regarding the luminous intensity of the lamp shall be met with the adjustment left unchanged compared to that for the original traffic direction:
- 4.12.2.1. Passing-beam designed for right-hand traffic and adapted to left-hand traffic:  
at  $0.86^\circ D - 1.72^\circ L$  at least  $2.50 \cdot 10^3$  cd;  
at  $0.57^\circ U - 3.43^\circ R$  not more than  $8.80 \cdot 10^2$  cd.
- 4.12.2.2. Passing-beam designed for left-hand traffic and adapted to right-hand traffic:  
at  $0.86^\circ D - 1.72^\circ R$  at least  $2.50 \cdot 10^3$  cd;  
at  $0.57^\circ U - 3.43^\circ L$  not more than  $8.80 \cdot 10^2$  cd.
- 4.13. If applicable, the lamp shall be so made that, if a light source and/or a LED module has failed, a failure signal in order to comply with the relevant provisions of UN Regulation No. 48 or UN Regulation No. 53 is provided.
- 4.14. The component(s) to which a replaceable light source is assembled shall be so made that the light source fits easily and, even in darkness, can be fitted in no position but the correct one.

<sup>7</sup> Instructions on the installation of lamps fitted with the measures are given in UN Regulation No. 48.

- 4.15. For photometric adjustment and measuring conditions, see Annex 4.
- 4.15.1 In the case of lamps with replaceable light sources, the lamp shall be considered acceptable if it meets the requirements of paragraph 5. with at least one standard (étalon) light source, which may be submitted with the lamp.
- 4.16. Colour of light emitted:  
The colour of the light emitted shall be white for all lamps. However, for front fog lamps the colour of the light emitted may be selective yellow if requested by the applicant.
- 4.17. In the case of headlamps or AFS with adjustable reflector the requirements of paragraphs 5.1. to 5.4. are applicable for each mounting position indicated according to paragraph 3.1.2.2.. For verification the following procedure shall be used:
- 4.17.1. Each applied position is realized on the test goniometer with respect to a line joining the centre of the light source and point HV on an aiming screen. The adjustable reflector/system or part(s) thereof is then moved into such a position that the light pattern on the screen corresponds to the relevant aiming prescriptions;
- 4.17.2. With the reflector/system or part(s) thereof initially fixed according to paragraph 4.17.1., the device or part(s) thereof must meet the relevant photometric requirements of paragraphs 5.1. to 5.4.;
- 4.17.3. Additional tests-shall be made after the reflector/system or part(s) thereof has been moved vertically  $\pm 2^\circ$  or at least into the maximum position, if less than  $2^\circ$ , from its initial position by means of the headlamps/systems or part(s) thereof adjusting device. Having re-aimed the headlamp/system or part(s) thereof as a whole (by means of the goniometer for example) in the corresponding opposite direction the light output in the following directions shall be controlled and lie within the required limits:
- passing-beam: for headlamp points B50L and 75R (B50R and 75L, respectively);  
for AFS points B50L and 75R, or 50R if applicable;  
for class AS, BS, CS and DS, points HV and 0.86D-V;
- driving-beam:  $I_{\max}$  and point HV (percentage of  $I_{\max}$ ).
- 4.18. A matched pair is allowed for:
- passing-beams of class C, V, AS, BS, CS or DS,
  - driving-beams of class A, B, BS, CS, DS or ADB,
  - front fog lamps.
- 4.19. For any road illumination devices listed in paragraph 1, in order to verify the visibility of white light towards the rear of a vehicle required in UN Regulation No. 48, the applicant may request a test, to show that in the angular field from  $165^\circ$  to  $180^\circ$  outboard in horizontal direction and  $-2.5^\circ$  to  $+5^\circ$  in vertical direction, the maximum luminous intensity is not more than  $2.5 \cdot 10^{-1}$  cd. This additional test may be conducted taking into account the influence of the vehicle body.

## 5. Specific Technical Requirements

- 5.1. Technical requirements concerning driving-beam of the Class A, B, RA, BS, CS or DS (symbols "R", "HR", "RA", "XR", "R-BS", "WR-CS" or "WR-DS")
- 5.1.1. The headlamp shall be aimed according to Annex 5, paragraph 3.1. including the allowed specific tolerances of paragraph 4.

For devices where more than one light source is used to provide the driving-beam, these light sources shall be operated simultaneously to determine the maximum value of the luminous intensity ( $I_{\max}$ ).

- 5.1.2. It is also possible that a part of the driving-beam produced by one of these light sources will be used exclusively for short time signals "flash to pass" as declared by the applicant. This shall be indicated in the relevant drawing and a remark shall be made in the communication form.
- 5.1.3. For the coordinates of any measuring point/line/zone a  $0.25^\circ$  tolerance is allowed independently at each test point for photometry unless indicated otherwise.
- 5.1.4. The luminous intensity distribution of the driving-beam, referring to Figures A4-II, A4-III or A4-IV, shall meet the requirements of Table 5.

Table 5

**Type approval photometric requirements for driving-beam**

Element	Angular coordinates in deg.		Minimum luminous intensity in cd					
	vertical	horizontal	Class A	Class B	Class RA (Auxiliary)	Class BS	Class CS (Secondary)	Class DS (Secondary)
2U-V	$2^\circ\text{U}$	$0^\circ$	$1.00 \cdot 10^3$	$1.70 \cdot 10^3$	-	-	$1.00 \cdot 10^3$	$1.70 \cdot 10^3$
H-12L	$0^\circ$	$12^\circ\text{L}$	$6.00 \cdot 10^2$	$1.50 \cdot 10^3$	-	-	-	-
H-9L	$0^\circ$	$9^\circ\text{L}$	$2.00 \cdot 10^3$	$3.40 \cdot 10^3$	-	-	-	-
H-6L	$0^\circ$	$6^\circ\text{L}$	$3.40 \cdot 10^3$	$5.00 \cdot 10^3$	-	$2.50 \cdot 10^3$	$3.40 \cdot 10^3$	$5.00 \cdot 10^3$
H-3L	$0^\circ$	$3^\circ\text{L}$	$1.20 \cdot 10^4$	$1.75 \cdot 10^4$	-	$9.00 \cdot 10^3$	$1.20 \cdot 10^4$	$1.75 \cdot 10^4$
H-V <sup>a</sup>	$0^\circ$	$0^\circ$	$0.8 \times I_{\max}$	$0.8 \times I_{\max}$	$0.8 \times I_{\max}$	$1.60 \cdot 10^4$	$2.00 \cdot 10^4$	$3.00 \cdot 10^4$
H-3R	$0^\circ$	$3^\circ\text{R}$	$1.20 \cdot 10^4$	$1.75 \cdot 10^4$	-	$9.00 \cdot 10^3$	$1.20 \cdot 10^4$	$1.75 \cdot 10^4$
H-6R	$0^\circ$	$6^\circ\text{R}$	$3.40 \cdot 10^3$	$5.00 \cdot 10^3$	-	$2.50 \cdot 10^3$	$3.40 \cdot 10^3$	$5.00 \cdot 10^3$
H-9R	$0^\circ$	$9^\circ\text{R}$	$2.00 \cdot 10^3$	$3.40 \cdot 10^3$	-	-	-	-
H-12R	$0^\circ$	$12^\circ\text{R}$	$6.00 \cdot 10^2$	$1.50 \cdot 10^3$	-	-	-	-
$I_{\max}$	-	-	$2.70 \cdot 10^4$	$4.00 \cdot 10^4$	$1.00 \cdot 10^4$	$2.00 \cdot 10^4$	$2.70 \cdot 10^4$	$4.00 \cdot 10^4$

Notes: In the Table 5

- <sup>a</sup> In case of a matched pair, the contribution of each lamp on H-V point shall not be less than 40 per cent of the relevant beam class minimum  $I_{\max}$  required.

- 5.1.4.1. Except for classes BS, CS and DS, the point of intersection (HV) of lines H-H and V-V shall be situated within the isocandela 80 per cent of maximum luminous intensity ( $I_{\max}$ )
- 5.1.4.2. The maximum value ( $I_{\max}$ ) shall not exceed  $2.15 \cdot 10^5$  cd in any direction.
- 5.1.4.2.1. The reference mark ( $I'_M$ ) of the maximum luminous intensity shall be obtained by the ratio:

$$I'_M = I_{\max} / 4,300$$

This value shall be rounded off to the value 2.5 - 5 - 7.5 - 10 - 12.5 - 17.5 - 20 - 25 - 27.5 - 30 - 37.5 - 40 - 45 - 50.

- 5.2. Technical requirements concerning headlamps to provide a passing-beam of the Class C and V (symbols "C" and "V")
- 5.2.1. The headlamp shall be aimed according to Annex 5, paragraph 3.2. including the allowed specific tolerances of paragraph 4.

If, however, vertical adjustment cannot be performed repeatedly to the required position within the allowed tolerances, the instrumental method of Annex 6, paragraph 2. shall be applied to test compliance with the required minimum

quality of the asymmetric "cut-off" line and to perform the beam vertical adjustment.

- 5.2.1.1. When so aimed, the headlamp shall:
- (i) If its approval is sought solely for provision of a passing-beam<sup>8</sup>, comply with the requirements set out in paragraph 5.2.2.;
  - (ii) If it is intended to provide both a passing-beam and a driving-beam, comply with the requirements set out in paragraphs 5.2.2. and 5.1.
- 5.2.2. The passing-beam shall meet the luminous intensities at the test points referred to in Table 6 and in Figure A4-V.

Table 6

**Type approval photometric requirements for Classes C and V passing-beam (indicated for right-hand traffic)**

	Element	Angular coordinates in deg.		Luminous intensity in cd			
		vertical	horizontal	Class C		Class V	
				min	max	min	max
Part A	Zone III	As specified in part C		-	$6.25 \cdot 10^2$	-	$6.25 \cdot 10^2$
	S50+S50LL+S50RR	As specified in part B		$1.90 \cdot 10^2$ <sup>b</sup>	-	-	-
	S100+S100LL+S100RR	As specified in part B		$3.75 \cdot 10^2$ <sup>b</sup>	-	-	-
	BR	1°U	2.5°R		$1.75 \cdot 10^3$		$1.75 \cdot 10^3$
	Segment BLL	0.57°U	8°L to 20°L		$6.25 \cdot 10^2$	-	$6.25 \cdot 10^2$
	B50L	0.57°U	3.43°L		$3.50 \cdot 10^2$		$3.50 \cdot 10^2$
	P	0°	7°L	$6.3 \cdot 10^1$		$6.3 \cdot 10^1$	
	75 R	0.57°D	1.15°R	$1.21 \cdot 10^4$	-	-	-
	50 L	0.86°D	3.43°L	$5.00 \cdot 10^3$ <sup>a</sup>	$3.70 \cdot 10^4$	$3.55 \cdot 10^3$ <sup>a</sup>	$3.70 \cdot 10^4$
	50 V	0.86°D	0°	$5.10 \cdot 10^3$ <sup>a</sup>	-	$5.10 \cdot 10^3$	-
	50 R	0.86°D	1.72°R	$1.01 \cdot 10^4$	-	$5.10 \cdot 10^3$	-
	Segment 50	0.86°D	6.84°L to 6.84°R	$2.54 \cdot 10^3$	-	$1.80 \cdot 10^3$	-
	Segment 40LL	1.07°D	14°L to 9°L	$8.50 \cdot 10^2$	-	$6.00 \cdot 10^2$	-
	40L	1.07°D	9°L	$2.80 \cdot 10^3$	-	$1.95 \cdot 10^3$	-
	40R	1.07°D	9°R	$2.80 \cdot 10^3$	-	$1.95 \cdot 10^3$	-
	Segment 40RR	1.07°D	9°R to 14°R	$8.50 \cdot 10^2$	-	$6.00 \cdot 10^2$	-
	25V	1.72°D	0°	$2.50 \cdot 10^3$	-	$1.75 \cdot 10^3$	-
	Segment 25L	1.72°D	16°L to 9°L	$1.18 \cdot 10^3$	-	$8.25 \cdot 10^2$	-
	Segment 25	1.72°D	9°L to 9°R	$1.70 \cdot 10^3$	-	$1.20 \cdot 10^3$	-
	Segment 25R	1.72°D	9°R to 16°R	$1.18 \cdot 10^3$	-	$8.25 \cdot 10^2$	-
Segment 15	2.86°D	20°L to 20°R	$4.25 \cdot 10^2$	-	$3.00 \cdot 10^2$	-	
Segment 10	4°D	4.5°L to 2°R	$5.00 \cdot 10^2$		$3.50 \cdot 10^2$		
Segment 10 and below	4°D	4.5°L to 2°R		0,8 x the actual measured value at 50R		0,8 x the actual measured value at 50R	
I <sub>max</sub>	-	-				$4.41 \cdot 10^4$	

Part B	Overhead sign requirements, angular position of measurement points						
	Element	S50LL	S50	S50RR	S100LL	S100	S100RR
	Angular coordinates in deg.						
	vertical	4°U	4°U	4°U	2°U	2°U	2°U
horizontal	8°L	0°	8°R	4°L	0°	4°R	

<sup>8</sup> Such a special "passing-beam" headlamp may incorporate a driving beam not subject to requirements.

Part C	<i>Zone III (bounded by the following coordinates)</i>								
	<i>Angular coordinates in deg.</i>								
	<i>vertical</i>	1°U	4°U	4°U	2°U	1.5°U	1.5°U	0°	0°
<i>horizontal</i>	8°L	8°L	8°R	8°R	6°R	1.5°R	0°	4°L	

Notes: In the Table 6, Part A, B and C:

- <sup>a</sup> In case of a matched pair the contribution of each lamp shall not be less than 50% of the required minimum value.
- <sup>b</sup> One pair of position lamps, being incorporated with the headlamp or being intended to be installed together with the headlamp may be activated according to the indications of the applicant.

- 5.2.3. There shall be no lateral variations detrimental to good visibility in any of the zones I, III and IV.
- 5.2.4. Headlamps designed to meet the requirements of both right-hand and left-hand traffic shall, in each of the two setting positions of the optical unit, light source(s) or light source module(s) producing the principal passing-beam, meet the requirements set forth above for the corresponding direction of traffic.
- 5.2.5. The requirements in paragraph 5.2.2. shall also apply to headlamps designed to provide bend lighting and/or that include the additional light source(s) or light source module(s) referred to in paragraph 5.2.6.
- 5.2.5.1. If bend lighting is obtained by:
- 5.2.5.1.1. Swivelling the passing-beam or moving horizontally the kink of the elbow of the cut-off, the measurements shall be carried out after the complete headlamp assembly has been re-aimed horizontally, e.g. by means of a goniometer;
- 5.2.5.1.2. Moving one or more optical parts of the headlamp without moving horizontally the kink of the elbow of the cut-off, measurements shall be carried out with these parts being in their extreme operating position;
- 5.2.5.1.3. Means of additional light source(s) or light source module(s) without moving horizontally the kink of the elbow of the cut-off, measurements shall be carried out with this/these light source(s) or light source module(s) activated.
- 5.2.6. Additional UN approved light sources and/or additional light source module(s) may be used inside the passing-beam headlamp to contribute to bend lighting;
- 5.2.7. Additional UN approved light sources and/or additional light source module(s), inside the passing-beam headlamp, may be used for the purposes of generating infrared radiation. It/they shall only be activated at the same time as the principal light source(s) or light source module(s). In the event that (one of) the principal light source(s) or (one of) the principal light source module(s) fails, this (these) additional light source(s) and/or light source module(s) shall be automatically switched OFF;
- 5.2.8. In the event of failure of one or more additional light source(s), or one or more additional light source module(s) as described in paragraphs 5.2.6. and 5.2.7., the headlamp shall continue to fulfil the requirements of the passing-beam.
- 5.3. Technical requirements concerning adaptive front-lighting systems (AFS) (symbols “XC”, “XCE”, “XCV”, “XCW” and “XR”)
- 5.3.1. General provisions
- 5.3.1.1. Each system shall provide a Class C passing-beam according to paragraph 5.3.2.4. and one or more passing-beam(s) of additional class(es); it may incorporate one or more additional modes within each class of passing-beam and the front-lighting functions according to paragraph 5.3.3. and/or 3.1.2.2.2.



- 5.3.1.2. The system shall provide automatic modifications, such, that good road illumination is achieved and no discomfort is caused, neither to the driver nor to other road users.
- 5.3.1.3. The system shall be considered acceptable if it meets the relevant photometric requirements of paragraphs 5.3.2. and 5.3.3.
- 5.3.1.4. Photometric measurements shall be performed according to the applicant's description:
- 5.3.1.4.1. At neutral state;
- 5.3.1.4.2. At V-signal, W-signal, E-signal, T-signal whichever apply;
- 5.3.1.4.3. If applicable, at any other signal(s) and combinations of them, according to the applicant's specification.
- 5.3.2. Provisions concerning the passing-beam
- The system shall, prior to the subsequent test procedures, be set to the neutral state, emitting the Class C passing-beam.
- 5.3.2.1. For each side of the system (vehicle) the passing-beam in its neutral state shall produce from at least one lighting unit a "cut-off" as defined in Annex 5 or,
- 5.3.2.1.1. The system shall provide other means, e.g. optical features or temporary auxiliary beams, allowing for unambiguous and correct aiming.
- 5.3.2.1.2. Annex 5 does not apply to the traffic-change function as described in paragraph 4.12.
- 5.3.2.2. The system or part(s) thereof shall be aimed according to the requirements of Annex 5 paragraph 3.2. including the allowed specific tolerances of paragraph 4 so that the position of the cut-off complies with the requirements indicated in the Table 8.
- If, however, vertical adjustment cannot be performed repeatedly to the required position within the allowed tolerances, the instrumental method of Annex 6, paragraph 2. shall be applied to test compliance with the required minimum quality of the asymmetric "cut-off" line and to perform the beam vertical adjustment.
- 5.3.2.3. When so aimed, the system or part(s) thereof,
- (a) If its approval is sought solely for provision of the passing-beam, needs to comply with the requirements set out in the relevant paragraphs;
- (b) If it is intended to provide additional lighting functions according to the scope of this Regulation, it shall comply in addition with the requirements set out in the relevant paragraphs, if not being adjustable independently.
- 5.3.2.4. When emitting a specified mode of the passing-beam, the system shall meet the requirements in the respective section (C, V, E, W) of part A of Table 7 (photometric values) and in Table 8 ( $I_{max}$  and "cut-off" positions), as well as paragraph 2.1. (asymmetric "cut-off" definition) of Annex 5.
- 5.3.2.5. A bending mode may be emitted, provided that:
- 5.3.2.5.1. The system meets the respective requirements of part B of Table 7 (photometric values) and item B of Table 8 ("cut-off" provisions), when measured according to the procedure indicated in paragraph 5.3.4., relevant to the category (either category 1 or category 2) of the bending mode, for which approval is sought;
- 5.3.2.5.2. When the T-signal corresponds to the vehicle's smallest turn radius to the left (or right), the sum of the luminous intensity values provided by all contributors of the right or the left side of the system shall be at least  $2.50 \cdot 10^3$  cd at one or

more points in the zone extending from H-H to 2° below H-H and from 10° to 45° left (or right);

- 5.3.2.5.3. If approval is sought for a category 1 bending mode, the use of the system is restricted to vehicles where provisions are taken such that the horizontal position of the "kink" of the "cut-off" which is provided by the system, complies with the relevant provisions of paragraph 6.22.7.4.5. (i) of UN Regulation No. 48;
- 5.3.2.5.4. If approval is sought for a category 1 bending mode, the system is designed so that, in the case of a failure affecting the lateral movement or modification of the illumination, it must be possible to obtain automatically either photometric conditions corresponding to paragraph 5.3.2.4. or a state with respect to the photometric conditions which yields values not exceeding  $1.30 \cdot 10^3$  cd in the zone IIIb, as defined in Table 9, and at least  $3.40 \cdot 10^3$  cd in a point of "segment  $I_{\max}$ ";
- However, this is not needed if, for positions relative to the system reference axis up to 5°L, at 0.3°U from H-H, and greater than 5°L, at 0.57°U, a value of  $8.80 \cdot 10^2$  cd is in no case exceeded.
- 5.3.2.6. The system shall be checked on the basis of the relevant instructions of the manufacturer, indicated in the safety concept according to paragraph 3.1.2.2.3.1.
- 5.3.2.7. A system or part(s) thereof, designed to meet the requirements of both right-hand and left-hand traffic must, in each of the two setting positions according to paragraph 4.10. meet the requirements specified for the corresponding direction of traffic.
- 5.3.2.8. The system shall be so made that:
- 5.3.2.8.1. Any specified passing-beam mode provides at least  $2.50 \cdot 10^3$  cd at point 50V from each side of the system;
- The mode(s) of the Class V passing-beam are exempted from this requirement;
- 5.3.2.8.2. Other modes:
- When signal inputs according to paragraph 5.3.1.4.2. apply, the requirements of the paragraph 5.3.2. shall be fulfilled.
- 5.3.2.9. Provisions for passing-beam

Table 7  
**Type approval photometric requirements for Classes C, V, E and W passing-beam  
in conjunction with Figure A4-VI (indicated for right-hand traffic)**

Element	Angular coordinates in deg.		Luminous intensity in cd							
	vertical	horizontal	Class C		Class V		Class E		Class W <sup>b</sup>	
			min	max	min	max	min	max	min	max
Zone III	As specified in Table 9		-	6.25·10 <sup>2</sup>	-	6.25·10 <sup>2</sup>	-	8.80·10 <sup>2</sup>	-	8.80·10 <sup>2</sup>
S50+S50LL+S50RR	As specified in Table 11		1.90·10 <sup>2 d</sup>	-	-	-	1.90·10 <sup>2 d</sup>	-	1.90·10 <sup>2 d</sup>	-
S100+S100LL+S100RR	As specified in Table 11		3.75·10 <sup>3 d</sup>	-	-	-	3.75·10 <sup>3 d</sup>	-	3.75·10 <sup>3 d</sup>	-
BR	1°U	2.5°R	-	1.75·10 <sup>3</sup>	-	1.75·10 <sup>3</sup>	-	1.75·10 <sup>3</sup>	-	2.65·10 <sup>3</sup>
Segment BLL	0.57°U	20°L to 8°L	-	6.25·10 <sup>2</sup>	-	6.25·10 <sup>2</sup>	-	8.80·10 <sup>2</sup>	-	8.80·10 <sup>2</sup>
B50L	0.57°U	3.43°L	-	3.50·10 <sup>2</sup>	--	3.50·10 <sup>2</sup>	-	6.25·10 <sup>2 c</sup>	-	6.25·10 <sup>2</sup>
P	0°	7°L	6.3·10 <sup>1</sup>	-	6.3·10 <sup>1</sup>	-	-	-	-	-
125R	0.34°D	1.15°R	-	-	-	-	1.20·10 <sup>4</sup>	-	-	-
75R	0.57°D	1.15°R	1.21·10 <sup>4</sup>	-	-	-	1.52·10 <sup>4</sup>	-	1.52·10 <sup>4</sup>	-
50L	0.86°D	3.43°L	5.00·10 <sup>3 f</sup>	3.70·10 <sup>4</sup>	3.55·10 <sup>3 f</sup>	3.70·10 <sup>4</sup>	6.80·10 <sup>3 f</sup>	-	6.80·10 <sup>3 f</sup>	3.70·10 <sup>4</sup>
50V	0.86°D	0°	5.10·10 <sup>3 f</sup>	-	5.10·10 <sup>3</sup>	-	1.01·10 <sup>4 a</sup>	-	1.01·10 <sup>4 a</sup>	-
50R	0.86°D	1.72°R	1.01·10 <sup>4</sup>	-	5.10·10 <sup>3</sup>	-	-	-	-	-
Segment 50	0.86°D	6.84°L to 6.84°R	2.54·10 <sup>3</sup>	-	1.80·10 <sup>3</sup>	-	2.54·10 <sup>3</sup>	-	2.54·10 <sup>3</sup>	-
40L	1.07°D	14°L	2.80·10 <sup>3</sup>	-	1.95·10 <sup>3</sup>	-	2.80·10 <sup>3</sup>	-	2.80·10 <sup>3</sup>	-
Segment 40LL	1.07°D	14°L to 9°L	8.50·10 <sup>2</sup>	-	6.00·10 <sup>2</sup>	-	8.50·10 <sup>2</sup>	-	8.50·10 <sup>2</sup>	-
40R	1.07°D	9°R	2.80·10 <sup>3</sup>	-	1.95·10 <sup>3</sup>	-	2.80·10 <sup>3</sup>	-	2.80·10 <sup>3</sup>	-
Segment 40RR	1.07°D	9°R to 14°R	8.50·10 <sup>2</sup>	-	6.00·10 <sup>2</sup>	-	8.50·10 <sup>2</sup>	-	8.50·10 <sup>2</sup>	-
25V	1.72°D	0°	2.50·10 <sup>3</sup>	-	1.75·10 <sup>3</sup>	-	2.50·10 <sup>3</sup>	-	-	-
Segment 25L	1.72°D	16°L to 9°L	1.18·10 <sup>3</sup>	-	8.25·10 <sup>2</sup>	-	1.18·10 <sup>3</sup>	-	1.18·10 <sup>3</sup>	-
Segment 25	1.72°D	9°L to 9°R	1.70·10 <sup>3</sup>	-	1.20·10 <sup>3</sup>	-	1.70·10 <sup>3</sup>	-	-	-
Segment 25R	1.72°D	9°R to 16°R	1.18·10 <sup>3</sup>	-	8.25·10 <sup>2</sup>	-	1.18·10 <sup>3</sup>	-	1.18·10 <sup>3</sup>	-
Segment 20 and below	2°D	3.5°L to 0°	-	-	-	-	-	-	-	1.76·10 <sup>4 b</sup>
Segment 15	2.86°D	20°L to 20°R	4.25·10 <sup>2</sup>	-	3.00·10 <sup>2</sup>	-	4.25·10 <sup>2</sup>	-	-	-
Segment 10	4°D	4.5°L to 2°R	5.00·10 <sup>2</sup>	-	3.50·10 <sup>2</sup>	-	5.00·10 <sup>2</sup>	-	-	-
Segment 10 and below	4°D	4.5°L to 2°R	-	0.8 x the actual measured value at 50R	-	0.8 x the actual measured value at 50R	-	0.8 x the actual measured value at 50R	-	7.10·10 <sup>3</sup>
I <sub>max</sub> <sup>c</sup>	-	-	-	-	-	4.41·10 <sup>4</sup>	-	-	-	-

Part B (bending mode): Table 7 applies, however the requirements for point B50L, Zone III and point 50L are indicated hereunder:

Element	Angular coordinates in deg.		Luminous intensity in cd							
	vertical	horizontal	Class C		Class V		Class E		Class W <sup>b</sup>	
			min	max	min	max	min	max	min	max
Zone III	As specified in Table 9		-	8.80·10 <sup>2</sup>	-	8.80·10 <sup>2</sup>	-	8.80·10 <sup>2</sup>	-	8.80·10 <sup>2</sup>
B50L	0.57°U	3.43°L	-	5.30·10 <sup>2</sup>	-	5.30·10 <sup>2</sup>	-	-	-	7.90·10 <sup>2</sup>
50L	0.86°D	3.43°L	1.70·10 <sup>3</sup>	-	1.70·10 <sup>3</sup>	-	3.40·10 <sup>3</sup>	-	3.40·10 <sup>3</sup>	-

Notes: In the Table 7, Part A and B:

- <sup>a</sup> The contribution of each side of the system shall not be less than 2.50·10<sup>3</sup> cd.
- <sup>b</sup> Requirements according to the provisions indicated in Table 10 apply in addition.
- <sup>c</sup> Position requirements according to the provisions of Table 8 ("Segment I<sub>max</sub>").
- <sup>d</sup> One pair of position lamps, being incorporated with the system or being intended to be installed together with the system may be activated according to the indications of the applicant.
- <sup>e</sup> Requirements according to the provisions indicated in Table 12 apply in addition.
- <sup>f</sup> The contribution of each side of the system shall not be less than 50% of the required minimum value.

Table 8  
**Passing-beam elements angular position/extend, additional requirements  
(indicated for right-hand traffic)**

	<i>Beam part designation and requirement</i>	<i>Angular coordinates in deg.</i>	
		<i>vertical</i>	<i>horizontal</i>
A	Angular position / extend for segment $I_{max}$	0.3 ° D to 1.72°D	0.5 ° L to 3 ° R
	The maximum luminous intensity in "Segment $I_{max}$ " as indicated in this Table shall be within the limits as prescribed in " $I_{max}$ " in Table 7.		
B	For Class C passing-beams the "cut-off" and part(s) of shall: (a) comply with the requirements of paragraph 1. of Annex 5 and		
	(b) be positioned with its "flat horizontal part" at	0.57°D	-

Table 9  
**Passing-beam zones III, defining corner points  
(indicated for right-hand traffic)**

<i>Element</i>	<i>Angular coordinates in deg.</i>								
	<i>Corner point No.</i>	<i>1</i>	<i>2</i>	<i>3</i>	<i>4</i>	<i>5</i>	<i>6</i>	<i>7</i>	<i>8</i>
Zone III a for Class C or Class V Passing-beam	<i>vertical</i>	1°U	4°U	4°U	2°U	1.5°U	1.5°U	0°	0°
	<i>horizontal</i>	8°L	8°L	8°R	8°R	6°R	1.5°R	0°	4°L
Zone III b for Class W or Class E Passing-beam	<i>vertical</i>	1°U	4°U	4°U	2°U	1.5°U	1.5°U	0.34°U	0.34°U
	<i>horizontal</i>	8°L	8°L	8°R	8°R	6°R	1.5°R	0.5°L	4°L

Table 10  
**Additional provisions for Class W passing-beam  
(indicated for right-hand traffic)**

<i>Element</i>	<i>Angular coordinates in deg.</i>		<i>Max. luminous intensity in cd</i>
	<i>vertical</i>	<i>horizontal</i>	
E	10°U	20°L to 20°R	1.75·10 <sup>2</sup>
F1	10°U to 60°U	10°L	
F2		0°	
F3		10°R	

Table 11  
**Overhead sign requirements, angular position of measurement points  
(indicated for right-hand traffic)**

<i>Element</i>	S50LL	S50	S50RR	S100LL	S100	S100RR
	<i>Angular coordinates in deg.</i>					
<i>vertical</i>	4°U	4°U	4°U	2°U	2°U	2°U
<i>horizontal</i>	8°L	0°	8°R	4°L	0°	4°R

Table 12  
**Additional provisions for Class E passing-beam  
(indicated for right-hand traffic)**

Part A of Table 7 applies, however the requirement for point B50L is replaced as indicated hereunder:

<i>Data Set</i>	<i>Angular coordinates in deg.</i>		<i>Max. luminous intensity in cd</i>
	<i>vertical</i>	<i>horizontal</i>	
E1	0.57°U	3.43°L	5.30·10 <sup>2</sup>
E2			4.40·10 <sup>2</sup>
E3			3.50·10 <sup>2</sup>

- 5.3.3. Provisions concerning the driving-beam
- The system shall, prior to the subsequent test procedures, be set to the neutral state.
- 5.3.3.1. The lighting unit(s) of the system shall be adjusted, according to the instructions of the manufacturer, such that the area of maximum illumination is centred on the point (HV) of intersection of the lines H-H and V-V;
- 5.3.3.1.1. Any lighting unit(s) which is/are not independently adjustable, or, for which the aiming was done with respect to any measurements under paragraphs 5.3.2., shall be tested in its/their unchanged position.
- 5.3.3.2. When measured according to the provisions laid down in paragraph 5.1. the luminous intensity shall meet the requirements of Class B in Table 5 and of paragraph 5.1.4.2.
- 5.3.3.3. The illumination or part thereof emitted by an AFS may be automatically laterally moved (or modified to obtain an equivalent effect), provided that:
- 5.3.3.3.1. The system meets the requirements of Class B in Table 5 and in paragraph 5.1.4.2. with each lighting unit measured according to the relevant procedure indicated in paragraph 5.3.4.
- 5.3.3.4. The system shall be so made that the lighting unit(s) of the right side and of the left side each provide at least  $1.62 \cdot 10^4$  cd at the point HV.
- 5.3.3.5. If the specified beam requirements are not met, a re-aiming of the beam position within the specific tolerances of Annex 5, paragraph 4, is allowed; in the revised position all photometric requirements shall be met.
- 5.3.3.6. In the case of adaptation of the driving-beam function the system shall meet the requirements of the above paragraphs only when it is in the maximum condition of activation.
- 5.3.3.7. During adaptation, the driving-beam function shall meet the requirements for all the cases of right-hand and left-hand traffic specified in Part A of Table 13. These requirements shall be verified during the type approval testing in conjunction with a signal generator to be provided by the applicant. This signal generator shall reproduce the signals provided by the vehicle and cause the adaptation of the driving-beam and in particular shall represent the settings so that the photometric compliance can be verified.
- 5.3.3.7.1. If the driving-beam function meets the requirements in Part A of Table 13 specified for line 1 to line 3 for oncoming and preceding vehicles (symmetrical beam) the relevant information shall be noticed in the communication document in Annex 1.
- 5.3.3.7.2. If the requirements of paragraph 5.3.3.7. can be met for right-hand traffic or left-hand traffic only, the relevant information shall be reported in the communication document in Annex 1.

Table 13  
**Type approval photometric requirements concerning the adaptation of  
the driving-beam**

	<i>Element</i>	<i>Angular coordinates in deg.</i>		<i>Max. luminous intensity<sup>b</sup> in cd</i>
		<i>vertical</i>	<i>horizontal</i>	
<i>Part A</i>	Line 1 Left Oncoming vehicle at 50 m in the case of right-hand traffic	0.57°U	4.8°L to 2°L	6.25·10 <sup>2</sup>
	Line 1 Right Oncoming vehicle at 50 m in the case of left-hand traffic	0.57°U	2°R to 4.8°R	6.25·10 <sup>2</sup>
	Line 2 Left Oncoming vehicle at 100 m in the case of right-hand traffic	0.3°U	2.4°L to 1°L	1.75·10 <sup>3</sup>
	Line 2 Right Oncoming vehicle at 100 m in the case of left-hand traffic	0.3°U	1°R to 2.4°R	1.75·10 <sup>3</sup>
	Line 3 Left Oncoming vehicle at 200 m in the case of right-hand traffic	0.15°U	1.2°L to 0.5°L	5.45·10 <sup>3</sup>
	Line 3 Right Oncoming vehicle at 200 m in the case of left-hand traffic	0.15°U	0.5°R to 1.2°R	5.45·10 <sup>3</sup>
	Line 4 Preceding vehicle at 50 m in the case of right-hand traffic	0.3°U	1.7°L to 1°R	1.85·10 <sup>3</sup>
			> 1°R to 1.7°R	2.50·10 <sup>3</sup>
	Line 4 Preceding vehicle at 50 m in the case of left-hand traffic	0.3°U	1.7°R to 1°L	1.85·10 <sup>3</sup>
			> 1°L to 1.7°L	2.50·10 <sup>3</sup>
	Line 5 Preceding vehicle at 100 m in the case of right-hand traffic	0.15°U	0.9°L to 0.5°R	5.30·10 <sup>3</sup>
			> 0.5°R to 0.9°R	7.00·10 <sup>3</sup>
	Line 5 Preceding vehicle at 100 m in the case of left-hand traffic		0.9°R to 0.5°L	5.30·10 <sup>3</sup>
		0.15°U	> 0.5°L to 0.9°L	7.00·10 <sup>3</sup>
Line 6 Preceding vehicle at 200 m in the case of left-hand traffic and right-hand traffic	0.1°U		0.45°L to 0.45°R	1.60·10 <sup>4</sup>

	<i>Element<sup>a</sup></i>	<i>Angular coordinates in deg.</i>		<i>Min. luminous intensity<sup>b</sup> in cd</i>
		<i>vertical</i>	<i>horizontal</i>	
<i>Part B</i>	50L	0.86°D	3.43°L	2.55·10 <sup>3</sup>
	50V	0.86°D	0°	5.10·10 <sup>3</sup>
	50R	0.86°D	1.72°R	5.10·10 <sup>3</sup>
	25LL	1.72°D	16°L	1.18·10 <sup>3</sup>
	25RR	1.72°D	11°R	1.18·10 <sup>3</sup>

Notes: In the Table 13, Part A and B

- <sup>a</sup> Angular positions are indicated for right-hand traffic.
- <sup>b</sup> The photometric requirements for each single measuring point or line (angular position) of this lighting function apply to half of the sum of the respective measured values from all lighting units of the system applied for this function. In case of class ADB for vehicle of category L3, not being part of a matched pair, this provision does not apply.
- Each of the lines defined in part A of Table 13, in conjunction with the test points as prescribed in part B of Table 13 shall be measured individually corresponding to the signal provided by the signal generator.

In the case where the passing-beam, which meets the requirements of paragraph 5.3.2., is continuously operated in conjunction with the adaptation of the driving-beam, the photometric requirements in Part B of the Table 13 shall not be applied.

- 5.3.4. Measurement conditions with respect to bending modes
- 5.3.4.1. In the case of a system or part(s) thereof, which provide a bending mode, the requirements of paragraphs 5.3.2. (passing-beam), and /or 5.3.3. (driving-beam) apply for all states, corresponding to the turn radius of the vehicle. For verification with respect to the passing-beam and the driving-beam the following procedure shall be used:
- 5.3.4.1.1. The system shall be tested in the neutral state (central/straight), and, in addition in the state(s) corresponding to the smallest turn radius of the vehicle in both directions using the signal generator, if applicable.
- 5.3.4.1.1.1. Compliance with the requirements of paragraphs 5.3.2.5.2. and 5.3.2.5.4. shall be checked for both category 1 and category 2 bending modes without additional horizontal re-aim.
- 5.3.4.1.1.2. Compliance with the requirements of paragraphs 5.3.2.5.1. and 5.3.3., whichever applies, shall be checked:
- (a) In case of a category 2 bending mode: without additional horizontal re-aim;
- (b) In case of a category 1 or a driving-beam bending mode: after having horizontally re-aimed the relevant installation unit (by means of the goniometer for example) in the corresponding opposite direction.
- 5.3.4.1.2. When testing a category 1 or category 2 bending mode, for a turn radius of the vehicle other than specified in paragraph 5.3.4.1.1. it shall be observed whether the light distribution is substantially uniform and no undue glare occurs. If this cannot be confirmed the compliance with the requirement laid down in Table 7 shall be checked.
- 5.3.5. Other provisions
- 5.3.5.1. It shall be stated by means of a form conforming to the model in Annex 1, which lighting unit(s) provide a "cut-off" as defined in Annex 5, that projects into a zone extending from 6°L to 4°R and upwards from a horizontal line positioned at 0.8°D.
- 5.3.5.2. It shall be stated by means of a form conforming to the model in Annex 1, which Class E passing-beam mode(s), if any, comply with a "data set" of Table 12.
- 5.4. Technical requirements concerning headlamps to provide a passing-beam of the Class AS, BS, CS and DS (symbols "C-AS", "C-BS", "WC-CS" and "WC-DS").
- 5.4.1. Aiming procedure
- 5.4.1.1. The headlamp shall be aimed according to Annex 5, paragraph 3.3. including the allowed specific tolerances of paragraph 4.
- If, however, vertical adjustment cannot be performed repeatedly to the required position within the allowed tolerances, the instrumental method of Annex 6, paragraph 2. shall be applied to test compliance with the required minimum quality of the symmetric "cut-off" line and to perform the beam vertical adjustment.
- 5.4.2. When so aimed, the headlamp must, if its approval is sought solely for provision of a passing-beam, comply with the requirements set out in paragraphs 5.4.3.; if it is intended to provide both a passing-beam and a driving-beam, it shall comply with the requirements set out in paragraphs 5.4.3. and 5.1.

5.4.3. The passing-beam shall meet the requirements as shown in the applicable table below and the applicable figure as shown in Annex 4.

5.4.3.1. For Class AS headlamps (Figure A4-VII in Annex 4)

Table 14

**Type approval photometric requirements for Class AS passing-beam**

Element	Angular coordinates in deg. <sup>a</sup>		Luminous intensity in cd	
	vertical	horizontal	min	max
Any point in Zone 1	0° to 15°U	5°L to 5°R		3.20·10 <sup>2</sup>
Any point on line 25L to 25R	1.72°D	5°L to 5°R	1.10·10 <sup>3</sup> <sup>b</sup>	
Any point on line 12.5L to 12.5R	3.43°D	5°L to 5°R	5.50·10 <sup>2</sup>	

Notes: In the Table 14

<sup>a</sup> 0.25° tolerance allowed independently at each test point for photometry unless indicated otherwise.

<sup>b</sup> In case of a matched pair the contribution of each lamp shall not be less than 50% of the required minimum value on 25V (1.72°D- V)

5.4.3.2. For Class BS headlamps (Figure A4-VIII in Annex 4)

Table 15

**Type approval photometric requirements for Class BS passing-beam**

Element	Angular coordinates in deg. <sup>a</sup>		Luminous intensity in cd	
	vertical	horizontal	min	max
Any point in Zone 1	0° to 15°U	5°L to 5°R		7.00·10 <sup>2</sup>
Any point on line 50L to 50R except 50V	0.86°D	2.5°L to 2.5°R	1.10·10 <sup>3</sup>	
Point 50V	0.86°D	0°	2.20·10 <sup>3</sup> <sup>b</sup>	
Any point on line 25L to 25R	1.72°D	5°L to 5°R	2.20·10 <sup>3</sup>	
Any point in Zone 2	0.86°D to 1.72°D	5°L to 5°R	1.10·10 <sup>3</sup>	

Notes: In the Table 15

<sup>a</sup> 0.25° tolerance allowed independently at each test point for photometry unless indicated otherwise.

<sup>b</sup> In case of a matched pair the contribution of each lamp shall not be less than 50% of the required minimum value for this test point.

5.4.3.3. For Classes CS and DS headlamps (Figure A4-IX in Annex 4)

Table 16

**Type approval photometric requirements for Class CS and Class DS passing-beam**

Element	Angular coordinates in deg. <sup>a</sup>		Luminous intensity in cd		
	vertical	horizontal	min		max
			Class CS	Class DS	Classes CS, DS
Zone 2	> 4°U to 15°U	8°L to 8°R	--	--	7.00·10 <sup>2</sup>
Zone 1	1°U/8°L-4°U/8°L-4°U/8°R-1°U/8°R-0°/4°R-0°/1°R-0.6°U/0°-0°/1°L-0°/4°L-1°U/8°L		--	--	9.00·10 <sup>2</sup>
P8	4°U	8°L	∑ 8 + 9 + 10 ≥ 1.50·10 <sup>2</sup> <sup>b</sup>		7.00·10 <sup>2</sup>
P9	4°U	0°			7.00·10 <sup>2</sup>
P10	4°U	8°R			7.00·10 <sup>2</sup>
P11	2°U	4°L	∑ 11 + 12 + 13 ≥ 3.00·10 <sup>2</sup> <sup>b</sup>		9.00·10 <sup>2</sup>
P12	2°U	0°			9.00·10 <sup>2</sup>
P13	2°U	4°R			9.00·10 <sup>2</sup>
P14L	0°	8°L	5.0·10 <sup>1</sup> <sup>b</sup>	5.0·10 <sup>1</sup> <sup>b</sup>	-



P15L	0°	4°L	1.00·10 <sup>2 b</sup>	1.00·10 <sup>2 b</sup>	9.00·10 <sup>2</sup>
P7	0°	0°	--	--	1.70·10 <sup>3</sup>
P15R	0°	4°R	1.00·10 <sup>2 b</sup>	1.00·10 <sup>2 b</sup>	9.00·10 <sup>2</sup>
P14R	0°	8°R	5.0·10 <sup>1 b</sup>	5.0·10 <sup>1 b</sup>	-
P3	0.86°D	3.5°L			1.38·10 <sup>4</sup>
P2	0.86°D	0°	2.45·10 <sup>3 c</sup>	4.90·10 <sup>3 c</sup>	-
P1	0.86°D	3.5°R			1.38·10 <sup>4</sup>
Segment 123	0.86°D	3.5°R to 3.5°L	2.00·10 <sup>3</sup>	2.00·10 <sup>3</sup>	-
Segment 4LL	1.07°D	9°L to 3.5°L	4.25·10 <sup>2</sup>	8.50·10 <sup>2</sup>	-
Segment 4RR	1.07°D	3.5°R to 9°R	4.25·10 <sup>2</sup>	8.50·10 <sup>2</sup>	-
Segment 5	2°D	15°L to 15°R	5.50·10 <sup>2</sup>	1.10·10 <sup>3</sup>	--
Segment 6	4°D	20°L to 20°R	1.50·10 <sup>2</sup>	3.00·10 <sup>2</sup>	0.8 x the actual measured value at point 2

Notes: In the Table 16

<sup>a</sup> 0.25° tolerance allowed independently at each test point for photometry unless indicated otherwise.

<sup>b</sup> The position lamp(s), being incorporated with the headlamp or being intended to be installed together with the headlamp may be activated according to the indications of the applicant.

<sup>c</sup> In case of a matched pair the contribution of each lamp shall not be less than 50% of the required minimum value.

5.4.3.3.1. The light shall be as evenly distributed as possible within zones 1 and 2 for Class CS or DS headlamps.

5.4.4. Additional light source(s) and/or additional lighting unit(s) used to produce bend lighting is (are) permitted for vehicles of categories L and T, provided that:

5.4.4.1. The following requirement regarding illumination shall be met, when the principal passing-beam(s) and corresponding additional light source(s) used to produce bend lighting are activated simultaneously:

(a) Left bank (when the motorcycle is rotated to the left about its longitudinal axis) the luminous intensity values shall not exceed 9.00·10<sup>2</sup> cd in the zone extending from H-H to 15°U and from V-V to 10°L.

(b) Right bank (when the motorcycle is rotated to the right about its longitudinal axis) the luminous intensity values shall not exceed 9.00·10<sup>2</sup> cd in the zone extending from H-H to 15°U and from V-V to 10°R.

5.4.4.2. This test shall be carried out with the minimum bank angle specified by the applicant simulating the condition by means of the test fixture etc.

5.4.4.3. For this measurement, at the request of the applicant, principal passing-beam and additional light source(s) used to produce bend lighting, may be measured individually and the photometric values obtained combined to determine compliance with the specified luminous intensity values.

5.5. Technical requirements concerning front fog lamps of the Class F3 (symbol "F3")

5.5.1. Photometric adjustment and measuring conditions

5.5.1.1. The front fog lamp shall be aimed according to Annex 5, paragraph 3.4. including the allowed specific tolerances of paragraph 4.

If, however, vertical adjustment cannot be performed repeatedly to the required position within the allowed tolerances, the instrumental method of Annex 6, paragraph 2. shall be applied to test compliance with the required minimum

quality of the symmetric "cut-off" line and to perform the beam vertical adjustment.

5.5.1.2. When so adjusted the front fog lamp shall meet the requirements as shown in Table 17 and Figure A4-X.

5.5.2. Photometric requirements

Table 17

**Type approval photometric requirements for front fog lamp**

<i>Element</i>	<i>Angular coordinates in deg.</i>		<i>Luminous intensity in cd</i>		<i>To comply</i>
	<i>vertical</i>	<i>horizontal</i>	<i>min</i>	<i>max</i>	
P1 and P2	60°U	45°L and 45°R	-	8.5·10 <sup>1</sup>	All points
P3 and P4	40°U	30°L and 30°R			
P5 and P6	30°U	60°L and 60°R			
P7 and P10	20°U	40°L and 40°R			
P8 and P9	20°U	15°L and 15°R			
Line 1	8°U	26°L to 26°R	-	1.30·10 <sup>2</sup>	All line
Line 2	4°U	26°L to 26°R	-	1.50·10 <sup>2</sup>	All line
Line 3	2°U	26°L to 26°R	-	2.45·10 <sup>2</sup>	All line
Line 4	1°U	26°L to 26°R	-	3.60·10 <sup>2</sup>	All line
Line 5	0°	10°L to 10°R	-	4.85·10 <sup>2</sup>	All line
Line 6 <sup>a</sup>	2.5°D	from 5° inwards to 10° outward	2.70·10 <sup>3</sup>	-	All line
Line 7 <sup>a</sup>	6°D	from 5° inwards to 10° outward	-	0.5 x the actual measured max. value on Line 6	All line
Line 8L and 8R	1.5°D to 3.5°D	22°L and 22°R	1.10·10 <sup>3</sup>	-	One or more points
Line 9L and 9R	1.5°D to 4.5°D	35°L and 35°R	4.50·10 <sup>2</sup>	-	One or more points
Zone D	1.5°D to 3.5°D	10°L to 10°R	-	1.20·10 <sup>4</sup>	Whole zone

Notes: In the Table 17

<sup>a</sup> In case of lamps constituting a matched pair, the half of the sum of the respective measured values from both lamps together does not apply to this element (see paragraph 1.5. of Annex 4)

5.5.2.1. The luminous intensity shall be measured either with white light or coloured light as prescribed by the applicant for use of the fog lamp in normal service. Variations in homogeneity detrimental to satisfactory visibility in the zone above the line 5 from 10°L to 10°R are not permitted.

5.5.2.2. Inside the field between lines 1 to 5 in Figure A4-X, the beam pattern should be substantially uniform. Discontinuities in intensities detrimental to satisfactory visibility between the lines 6, 7, 8 and 9 are not permitted.

5.5.2.3. In the light-distribution as specified in Table 17, single narrow spots or stripes inside the area including the measuring points 1 to 10 and line 1 or inside the area of line 1 and line 2 with not more than 1.75·10<sup>2</sup> cd are allowed, if not extending beyond a conical angle of 2° aperture or a width of 1°. If multiple spots or stripes are present, they shall be separated by a minimum angle of 10°.

5.5.3. Other photometric requirements

5.5.3.1. To adapt to dense fog or similar conditions of reduced visibility, it is permitted to automatically vary the luminous intensities provided that:

- An active electronic light source control gear is incorporated into the front fog lamp function system;
- All intensities are varied proportionately.

The system, when checked for compliance according to the provisions of paragraph 4.6.2.1., is considered acceptable if the luminous intensities remain within 60 per cent and 100 per cent of the values specified in Table 17.

- 5.5.3.1.1. An indication shall be inserted in the communication form (Annex 1, item 9).
- 5.5.3.1.2. The Technical Service responsible for type approval shall verify that the system provides automatic modifications, such that good road illumination is achieved and no discomfort is caused to the driver or to other road users.
- 5.5.3.1.3. Photometric measurements shall be performed according to the applicant's description.
- 5.6. Technical requirements concerning cornering lamps (symbol K)
- 5.6.1. Intensity of light emitted

The cornering lamp shall be installed on the goniometer according to Annex 5, paragraph 3.5. including the allowed specific tolerances of paragraph 4.

For a left side lamp, the intensity of the light at the specified measuring points and zones shall be as indicated in Table 18.

Table 18:

**Type approval photometric requirements for cornering lamp (left side lamp)**

Element	Angular coordinates in deg. <sup>a</sup>		Luminous intensity in cd	
	vertical	horizontal	min	max
Zone 1	Above 1°U	90°L to 90°R	-	3.00·10 <sup>2</sup>
Zone 2	0° to 1°U	90°L to 90°R	-	6.00·10 <sup>2</sup>
Zone 3	Below 0°	90°L to 90°R	-	1.40·10 <sup>4</sup>
P1	2.5°D	30°L	3.75·10 <sup>2</sup>	-
P2	2.5°D	45°L	6.25·10 <sup>2</sup>	-
P3	2.5°D	60°L	3.75·10 <sup>2</sup>	-

Notes: In the Table 18

<sup>a</sup> 0.25° tolerance allowed independently at each test point for photometry, unless indicated otherwise.

- 5.6.2. In the case of a single lamp containing more than one light source when all light sources are illuminated the maximum intensities shall not be exceeded.
- 5.6.3. Failure of a single lamp containing more than one light source:
- 5.6.3.1. In a single lamp containing more than one light source, a group of light sources, wired so that the failure of any one of them causes all of them to stop emitting light, shall be considered to be one light source.
- 5.6.3.2. In case of failure of any one light source in a single lamp containing more than one light source, at least one of the following provisions shall apply:
- (a) The light intensity complies with the minimum intensity required in the table of standard light distribution in space as shown in Table 18; or
- (b) A signal for activation of a tell-tale indicating failure, as indicated in paragraph 6.20.8. of UN Regulation No. 48, is produced, provided that the luminous intensity at 2.5°D 45°L for a left-side lamp (the L angle should be substituted for the R angle for a right-side lamp) is at least 50 per cent of the minimum intensity required. In this case a note in the communication form states that the lamp is only for use on a vehicle fitted with a tell-tale indicating failure.
- 5.6.4. Measurement methods
- 5.6.4.1. Measuring points expressed in degrees of angle with the axis of reference are shown in Figure A4-XI.
- 5.6.4.2. Horizontal and vertical angles for the field of geometric visibility are shown in Figures A4-XII and A4-XIII. The directions H = 0° and V = 0° correspond to

the axis of reference. On the vehicle they are horizontal, parallel to the median longitudinal plane of the vehicle and oriented in the required direction of visibility. They pass through the centre of reference.

## 6. Conformity of Production

- 6.1. General
  - 6.1.1. Road illumination devices approved under this Regulation shall be so manufactured as to conform to the type approved by meeting the requirements set forth in paragraphs 4.16. and 5.
    - 6.1.1.1. The minimum requirements for conformity of production control procedures set forth in Annex 2 shall be complied with;
    - 6.1.1.2. The minimum requirements for sampling by an inspector set forth in Annex 3 shall be complied with.
  - 6.1.2. The Type Approval Authority which has granted type approval may at any time verify the conformity control methods applied in each production facility. The normal frequency of these verifications shall be once every two years.
  - 6.1.3. Road illumination devices with apparent defects are disregarded.
  - 6.1.4. The reference mark is disregarded.
  - 6.1.5. The measuring points in Table 6 Part B are disregarded.
  - 6.1.6. The measuring points P8 to P15 in Table 16 are disregarded.
  - 6.1.7. Testing with LED substitute light sources is exempted from conformity of production control
  - 6.1.8. The conformity requirements shall be considered satisfied from a mechanical and a geometric standpoint, in accordance with the requirements of this Regulation, if any, if the differences do not exceed inevitable manufacturing deviations.
  - 6.1.9. In the case of cornering lamps using non-replaceable filament light source(s) or light source module(s) equipped with non-replaceable filament light sources, at any conformity of production check:
    - 6.1.9.1. the holder of the approval mark shall demonstrate the use in normal production and show the identification of the non-replaceable filament light source(s) as indicated in the type approval documentation;
    - 6.1.9.2. in the case where doubt exists in respect to compliance of the non-replaceable filament light source(s) with lifetime requirements and/or, in the case of colour coated filament light sources, with colour endurance requirements, as specified in paragraph 4.11 of IEC 60809, Edition 3, conformity shall be checked as specified in paragraph 4.11 of IEC 60809, Edition 3.
- 6.2. Photometric performance
  - 6.2.1. With respect to photometric performances, the conformity of mass-produced lamps shall not be contested if, when testing photometric performances of any lamp chosen at random and equipped with a standard (étalon) light source and/or non-replaceable light source(s) and/or light source module(s), as present in the lamp;
    - 6.2.1.1. If not otherwise specified, no measured value deviates unfavorably by more than 20 per cent from the value prescribed in this Regulation.
      - 6.2.1.1.1. For class C and V passing-beam corresponding to paragraphs 5.2. of this Regulation the conformity of mass-produced lamps shall not be contested if:

6.2.1.1.1.1. the maximum unfavorable deviation for the point B50L (or R) and zone III, may be respectively:

B50L (or R):             $1.70 \cdot 10^2$  cd equivalent 20 per cent  
                                   $2.55 \cdot 10^2$  cd equivalent 30 per cent

Zone III:                 $2.55 \cdot 10^2$  cd equivalent 20 per cent  
                                   $3.80 \cdot 10^2$  cd equivalent 30 per cent

and no measured value deviates unfavorably by more than 20 per cent from the value prescribed in Table 6 for all other elements (points, segments and zones).

or:

6.2.1.1.1.2. at one point within a circle of 0.35 degrees radius around points B50L (or R) (with a tolerance of 85 cd), 75R (or L), 50V, 40R, 40L, and in the entire segment 50, the values prescribed in Table 6 are met (the deviation of 20 per cent from the values prescribed does not apply).

6.2.1.1.1.2.1. and if, for the driving beam, HV being situated within the isocandela  $0.75 I_{\max}$  a tolerance of +20 per cent for maximum values and -20 per cent for minimum values is observed for the photometric values at any measuring point specified in paragraph 5.1. of this Regulation

6.2.1.1.1.3. If the results of the test described above do not meet the requirements, the alignment of the headlamp may be changed according to the provisions in Annex 5, paragraph 4.1.

6.2.1.1.2. For class BS, CS and DS headlamps corresponding to paragraph 5.4. of this Regulation for values in zone I, the maximum unfavorable deviation may be respectively:

Zone I:                  $2.55 \cdot 10^2$  cd equivalent 20 per cent  
                                   $3.80 \cdot 10^2$  cd equivalent 30 per cent

6.2.1.1.2.1. If the results of the test described above do not meet the requirements, the alignment of the headlamp may be changed according to the provisions in Annex 5, paragraph 4.1.

6.2.1.1.3. For front fog lamps corresponding to paragraph 5.5. of this Regulation, Table 19 shall apply;

Table 19

**Conformity of production, photometric requirements for front fog lamp**

Element	Angular coordinates in deg.		Luminous intensity in cd				To comply
			Equivalent 20 per cent		Equivalent 30 per cent		
	vertical	horizontal	min	max	min	max	
P1 and P2	60°U	45°L and 45°R	-	$1.15 \cdot 10^2$	-	$1.30 \cdot 10^2$	All points
P3 and P4	40°U	30°L and 30°R					
P5 and P6	30°U	60°L and 60°R					
P7 and P10	20°U	40°L and 40°R					
P8 and P9	20°U	15°L and 15°R					
Line 1	8°U	26°L to 26°R	-	$1.60 \cdot 10^2$	-	$1.70 \cdot 10^2$	All line
Line 2	4°U	26°L to 26°R	-	$1.80 \cdot 10^2$	-	$1.95 \cdot 10^2$	All line
Line 3	2°U	26°L to 26°R	-	$2.95 \cdot 10^2$	-	$3.20 \cdot 10^2$	All line
Line 4	1°U	26°L to 26°R	-	$4.35 \cdot 10^2$	-	$4.70 \cdot 10^2$	All line
Line 5	0°	10°L to 10°R	-	$5.85 \cdot 10^2$	-	$6.30 \cdot 10^2$	All line
Line 6 <sup>a</sup>	2.5°D	from 5° inwards to 10° outward	$2.16 \cdot 10^3$	-	$1.89 \cdot 10^3$	-	All line
Line 8L and 8R	1.5°D to 3.5°D	22°L and 22°R	$8.80 \cdot 10^2$	-	$7.70 \cdot 10^2$	-	One or more points

Line 9L and 9 R	1.5°D to 4.5°D	35°L and 35°R	3.60·10 <sup>2</sup>	-	3.15·10 <sup>2</sup>	-	One or more points
Zone D	1.5°D to 3.5°D	10°L to 10°R	-	1.44·10 <sup>4</sup>	-	1.56·10 <sup>4</sup>	Whole zone

Notes: In the Table 19

<sup>a</sup> In case of lamps constituting a matched pair, the half of the sum of the respective measured values from both lamps together does not apply to this element (see paragraph 1.5. of Annex 4)

- 6.2.1.1.3.1 In the light-distribution as specified in Table 19, single narrow spots or stripes inside the area including the measuring points 1 to 10 and line 1 or inside the area of line 1 and line 2 with not more than 2.10·10<sup>2</sup> cd are allowed, if not extending beyond a conical angle of 2° aperture or a width of 1°. If multiple spots or stripes are present, they shall be separated by a minimum angle of 10°.
- 6.2.1.1.3.2. If the results of the test described above do not meet the requirements, the alignment of the front fog lamp may be changed according to the provisions in Annex 5, paragraph. 4.1.
- 6.2.1.1.4. For AFS corresponding to paragraph 5.3. no value measured and corrected according to the prescriptions of paragraph 4.6., deviates unfavourably from the value prescribed in column B of the Tables 21 to 36, if applicable.
- 6.2.1.1.4.1. Passing-beam Photometric Requirements

Table 20  
**Decision Table**

	<i>"Multiple Modes"- Condition * if more than one mode of the applicable Class exists only the mode which represents the worst condition has to be tested in non-bending mode according to</i>	<i>"Bending Modes" - Condition if the system uses the same functional units to obtain bending modes for more than one class:</i>	
		<i>Yes</i>	<i>No</i>
Class C	Table 21*		
Category 1 bending mode	→	** the bending modes shall only be tested in the Class which represents the worst condition	Table 22
Category 2 bending mode		Test category 2 bending mode according to Table 23	
Class V Non-Bending Mode	Table 24*		
Class V Category 1 bending mode	→	see **	Table 25
Class V Category 2 bending mode			Table 26
Class W Non-bending mode	Table 27*		
Class W Category 1 bending mode	→	see **	Table 28
Class W Category 2 bending mode			Table 29
Class E	if more than one mode of Class E exists only the mode Class E which relates to the highest cut-off position has to be tested in non-bending mode according to corresponding Table 30 to Table 33	No additional testing of Category 1 and/or Category 2 is necessary	

Table 21  
**Class C – Neutral State (non-bending mode) – System Requirements**  
**(indicated for right-hand traffic)**

Element	Angular coordinates in deg.		Luminous intensity in cd					
			Column A		Column B		Column C	
	vertical	horizontal	± 0% CoP		± 20% CoP		± 30% CoP	
			min	max	min	max	min	max
S50+S50LL+S50RR	As specified in Table 11		$1.90 \cdot 10^2$ a	-	$9.5 \cdot 10^1$ a	-	$4.5 \cdot 10^1$ a	-
S100+S100LL+S100RR	As specified in Table 11		$3.75 \cdot 10^2$ a	-	$1.85 \cdot 10^2$ a	-	$9.0 \cdot 10^1$ a	-
BR	1°U	2.5°R	-	$1.75 \cdot 10^3$	-	$2.10 \cdot 10^3$	-	$2.28 \cdot 10^3$
Point BLL	0.57°U	8°L	-	$6.25 \cdot 10^2$	-	$8.80 \cdot 10^2$	-	$1.01 \cdot 10^3$
B50L	0.57°U	3.43°L	-	$3.50 \cdot 10^2$	-	$5.20 \cdot 10^2$	-	$6.05 \cdot 10^2$
Line III	0°	4°L to 0°	-	$6.25 \cdot 10^2$	-	$8.80 \cdot 10^2$	-	$1.01 \cdot 10^3$
75R	0.57°D	1.15°R	$1.21 \cdot 10^4$	-	$9.68 \cdot 10^3$	-	$8.47 \cdot 10^3$	-
50L	0.86°D	3.43°L	$5.00 \cdot 10^3$	$3.70 \cdot 10^4$	$4.00 \cdot 10^3$	$4.44 \cdot 10^4$	$3.50 \cdot 10^3$	$4.81 \cdot 10^4$
50V	0.86°D	0°	$5.10 \cdot 10^3$	-	$4.08 \cdot 10^3$	-	$3.57 \cdot 10^3$	-
50R	0.86°D	1.72°R	$1.01 \cdot 10^4$	-	$8.08 \cdot 10^3$	-	$7.07 \cdot 10^3$	-
25LL	1.72°D	16°L	$1.18 \cdot 10^3$	-	$9.44 \cdot 10^2$	-	$8.26 \cdot 10^2$	-
25RR	1.72°D	11°R	$1.18 \cdot 10^3$	-	$9.44 \cdot 10^2$	-	$8.26 \cdot 10^2$	-
Segment 10	4°D	4.5°L to 2°R		0,8 x the actual measured value at 50R		0,8 x the actual measured value at 50R		0,8 x the actual measured value at 50R

Notes: In the Table 21:

<sup>a</sup> One pair of position lamps, being incorporated with the system or being intended to be installed together with the system may be activated according to the indications of the applicant.

Table 22  
**Class C – Bend lighting – Category 1 – System Requirements**  
**(indicated for right-hand traffic)**

Element	Angular coordinates in deg.		Luminous intensity in cd					
			Column A		Column B		Column C	
	vertical	horizontal	± 0% CoP		± 20% CoP		± 30% CoP	
			min	max	min	max	min	max
BR	1°U	2.5°R	-	$1.75 \cdot 10^3$	-	$2.10 \cdot 10^3$	-	$2.28 \cdot 10^3$
Point BLL	0.57°U	8°L	-	$6.25 \cdot 10^2$	-	$8.80 \cdot 10^2$	-	$1.01 \cdot 10^3$
B50L	0.57°U	3.43°L	-	$5.30 \cdot 10^2$	-	$7.00 \cdot 10^2$	-	$7.85 \cdot 10^2$
Line III	0°	4°L to 0°	-	$8.80 \cdot 10^2$	-	$1.14 \cdot 10^3$	-	$1.26 \cdot 10^3$
75R	0.57°D	1.15°R	$1.21 \cdot 10^4$	-	$9.68 \cdot 10^3$	-	$1.21 \cdot 10^4$	-
50L	0.86°D	3.43°L	$1.70 \cdot 10^3$	-	$1.36 \cdot 10^3$	-	$1.19 \cdot 10^3$	-
50V	0.86°D	0°	$5.10 \cdot 10^3$	-	$4.08 \cdot 10^3$	-	$5.10 \cdot 10^3$	-
50R	0.86°D	1.72°R	$1.01 \cdot 10^4$	-	$8.08 \cdot 10^3$	-	$7.07 \cdot 10^3$	-

Table 23  
**Class C – Bend lighting – Category 2 – System Requirements**  
**(indicated for right-hand traffic)**

Element	Angular coordinates in deg		Luminous intensity in cd					
			Column A		Column B		Column C	
			± 0% CoP		± 20% CoP		± 30% CoP	
	vertical	horizontal	min	max	min	max	min	max
BR	1°U	2.5°R	-	1.75·10 <sup>3</sup>	-	2.10·10 <sup>3</sup>	-	2.28·10 <sup>3</sup>
Line BLL	0.57° U	20°L to 8°L	-	6.25·10 <sup>2</sup>	-	8.80·10 <sup>2</sup>	-	1.01·10 <sup>3</sup>
B50L	0.57° U	3.43°L	-	5.30·10 <sup>2</sup>	-	7.00·10 <sup>2</sup>	-	7.85·10 <sup>2</sup>
Line III	0°	4° L to 0°	-	8.80·10 <sup>2</sup>	-	1.14·10 <sup>3</sup>	-	1.26·10 <sup>3</sup>

Table 24  
**Class V – non-bending mode – System Requirements**  
**(indicated for right-hand traffic)**

Element	Angular coordinates in deg		Luminous intensity in cd					
			Column A		Column B		Column C	
			± 0% CoP		± 20% CoP		± 30% CoP	
	vertical	horizontal	min	max	min	max	min	max
BR	1°U	2.5°R	-	1.75·10 <sup>3</sup>	-	2.10·10 <sup>3</sup>	-	2.28·10 <sup>3</sup>
Point BLL	0.57°U	8°L	-	6.25·10 <sup>2</sup>	-	8.80·10 <sup>2</sup>	-	1.01·10 <sup>3</sup>
B50L	0.57°U	3.43°L	-	3.50·10 <sup>2</sup>	-	5.20·10 <sup>2</sup>	-	6.05·10 <sup>2</sup>
Line III	0°	4°L to 0°	-	6.25·10 <sup>2</sup>	-	8.80·10 <sup>2</sup>	-	1.01·10 <sup>3</sup>
50L	0.86°D	3.43°L	3.55·10 <sup>3</sup>	3.70·10 <sup>4</sup>	2.84·10 <sup>3</sup>	4.44·10 <sup>4</sup>	2.49·10 <sup>3</sup>	4.81·10 <sup>4</sup>
50R	0.86°D	1.72°R	5.10·10 <sup>3</sup>	4.41·10 <sup>4</sup>	4.08·10 <sup>3</sup>	5.29·10 <sup>4</sup>	3.57·10 <sup>3</sup>	5.73·10 <sup>4</sup>

Table 25  
**Class V – Bend lighting – Category 1 – System Requirements**  
**(indicated for right-hand traffic)**

Element	Angular coordinates in deg		Luminous intensity in cd					
			Column A		Column B		Column C	
			± 0% CoP		± 20% CoP		± 30% CoP	
	vertical	horizontal	min	max	min	max	min	max
BR	1°U	2.5°R	-	1.75·10 <sup>3</sup>	-	2.10·10 <sup>3</sup>	-	2.28·10 <sup>3</sup>
Point BLL	0.57°U	8°L	-	8.80·10 <sup>2</sup>	-	1.14·10 <sup>3</sup>	-	1.26·10 <sup>3</sup>
B50L	0.57°U	3.43°L	-	5.30·10 <sup>2</sup>	-	7.00·10 <sup>2</sup>	-	7.85·10 <sup>2</sup>
Line III	0°	4°L to 0°	-	8.80·10 <sup>2</sup>	-	1.14·10 <sup>3</sup>	-	1.26·10 <sup>3</sup>
50L	0.86°D	3.43°L	1.70·10 <sup>3</sup>	-	1.36·10 <sup>3</sup>	-	1.19·10 <sup>3</sup>	-
50R	0.86°D	1.72°R	5.10·10 <sup>3</sup>	4.41·10 <sup>4</sup>	4.08·10 <sup>3</sup>	5.29·10 <sup>4</sup>	3.57·10 <sup>3</sup>	5.73·10 <sup>4</sup>



Table 26  
**Class V – Bend lighting – Category 2 – System Requirements**  
**(indicated for right-hand traffic)**

Element	Angular coordinates in deg		Luminous intensity in cd					
			Column A		Column B		Column C	
	vertical	horizontal	± 0% CoP		± 20% CoP		± 30% CoP	
			min	max	min	max	min	max
BR	1°U	2.5°R	-	1.75·10 <sup>3</sup>	-	2.10·10 <sup>3</sup>	-	2.28·10 <sup>3</sup>
Line BLL	0.57° U	20°L to 8°L	-	8.80·10 <sup>2</sup>	-	1.14·10 <sup>3</sup>	-	1.26·10 <sup>3</sup>
B50L	0.57° U	3.43°L	-	5.30·10 <sup>2</sup>	-	7.00·10 <sup>2</sup>	-	7.85·10 <sup>2</sup>
Line III	0°	4° L to 0°	-	8.80·10 <sup>2</sup>	-	1.14·10 <sup>3</sup>	-	1.26·10 <sup>3</sup>

Table 27  
**Class W – Non-bending mode – System Requirements**  
**(indicated for right-hand traffic)**

Element	Angular coordinates in deg.		Luminous intensity in cd					
			Column A		Column B		Column C	
	vertical	horizontal	± 0% CoP		± 20% CoP		± 30% CoP	
			min	max	min	max	min	max
BR	1°U	2.5°R	-	2.65·10 <sup>3</sup>	-	3.18·10 <sup>3</sup>	-	3.45·10 <sup>3</sup>
Point BLL	0.57°U	8°L	-	8.80·10 <sup>2</sup>	-	1.14·10 <sup>3</sup>	-	1.26·10 <sup>3</sup>
B50L	0.57°U	3.43°L	-	6.25·10 <sup>2</sup>	-	8.80·10 <sup>2</sup>	-	1.01·10 <sup>3</sup>
Line III b	0.34°U	4°L to 0.5°L	-	8.80·10 <sup>2</sup>	-	1.14·10 <sup>3</sup>	-	1.26·10 <sup>3</sup>
75R	0.57°D	1.15°R	1.52·10 <sup>4</sup>	-	1.22·10 <sup>4</sup>	-	1.06·10 <sup>4</sup>	-
50L	0.86°D	3.43°L	6.80·10 <sup>3</sup>	3.70·10 <sup>4</sup>	5.44·10 <sup>3</sup>	4.44·10 <sup>4</sup>	4.76·10 <sup>3</sup>	4.81·10 <sup>4</sup>
25LL	1.72°D	16°L	1.18·10 <sup>3</sup>	-	9.44·10 <sup>2</sup>	-	8.26·10 <sup>2</sup>	-
25RR	1.72°D	11°R	1.18·10 <sup>3</sup>	-	9.44·10 <sup>2</sup>	-	8.26·10 <sup>2</sup>	-
Segment 20	2°D	3.5°L to 0°	-	1.76·10 <sup>4</sup>	-	2.11·10 <sup>4</sup>	-	2.29·10 <sup>4</sup>
Segment 10	4°D	4.5°L to 2°R	-	7.10·10 <sup>3</sup>	-	8.52·10 <sup>3</sup>	-	9.23·10 <sup>3</sup>

Table 28  
**Class W – Bend lighting – Category 1 – System Requirements**  
**(indicated for right-hand traffic)**

Element	Angular coordinates in deg.		Luminous intensity in cd					
			Column A		Column B		Column C	
	vertical	horizontal	± 0% CoP		± 20% CoP		± 30% CoP	
			min	max	min	max	min	max
BR	1°U	2.5°R	-	7.90·10 <sup>2</sup>	-	9.60·10 <sup>2</sup>	-	1.05·10 <sup>3</sup>
Point BLL	0.57°U	8°L	-	8.80·10 <sup>2</sup>	-	1.14·10 <sup>3</sup>	-	1.26·10 <sup>3</sup>
B50L	0.57°U	3.43°L	-	7.90·10 <sup>2</sup>	-	9.60·10 <sup>2</sup>	-	1.05·10 <sup>3</sup>
Line III b	0.34°U	4°L to 0.5°L	-	8.80·10 <sup>2</sup>	-	1.14·10 <sup>3</sup>	-	1.26·10 <sup>3</sup>
75R	0.57°D	1.15°R	1.52·10 <sup>4</sup>	-	1.22·10 <sup>4</sup>	-	1.06·10 <sup>4</sup>	-
50L	0.86°D	3.43°L	3.40·10 <sup>3</sup>	-	2.72·10 <sup>3</sup>	-	2.38·10 <sup>3</sup>	-

Table 29  
**Class W – Bend lighting – Category 2 – System Requirements**  
**(indicated for right-hand traffic)**

Element	Angular coordinates in deg.		Luminous intensity in cd					
			Column A		Column B		Column C	
	vertical	horizontal	± 0% CoP		± 20% CoP		± 30% CoP	
			min	max	min	max	min	max

BR	1°U	2.5°R	-	$7.90 \cdot 10^2$	-	$9.60 \cdot 10^2$	-	$1.05 \cdot 10^3$
Line BLL	0.57°U	20°L to 8°L	-	$8.80 \cdot 10^2$	-	$1.14 \cdot 10^3$	-	$1.26 \cdot 10^3$
B50L	0.57°U	3.43°L	-	$7.90 \cdot 10^2$	-	$9.60 \cdot 10^2$	-	$1.05 \cdot 10^3$
Line III b	0.34°U	4°L to 0.5°L	-	$8.80 \cdot 10^2$	-	$1.14 \cdot 10^3$	-	$1.26 \cdot 10^3$

Table 30  
Class E – Non-bending mode (indicated for right-hand traffic)

Element	Angular coordinates in deg.		Luminous intensity in cd					
			Column A		Column B		Column C	
	vertical	horizontal	± 0% CoP		± 20% CoP		± 30% CoP	
			min	max	min	max	min	max
BR	1°U	2.5°R	-	$1.75 \cdot 10^3$	-	$2.10 \cdot 10^3$	-	$2.28 \cdot 10^3$
Point BLL	0.57°U	8°L	-	$8.80 \cdot 10^2$	-	$1.14 \cdot 10^3$	-	$1.26 \cdot 10^3$
B50L	0.57°U	3.43°L	-	$6.25 \cdot 10^2$	-	$8.80 \cdot 10^2$	-	$1.01 \cdot 10^3$
Line III b	0.34°U	4°L to 0.5°L	-	$8.80 \cdot 10^2$	-	$1.14 \cdot 10^3$	-	$1.26 \cdot 10^3$
75R	0.57°D	1.15°R	$1.52 \cdot 10^4$	-	$1.22 \cdot 10^4$	-	$1.06 \cdot 10^4$	-
50L	0.86°D	3.43°L	$6.80 \cdot 10^3$	-	$5.44 \cdot 10^3$	-	$4.76 \cdot 10^3$	-
50V	0.86°D	0°	$1.01 \cdot 10^4$	-	$8.08 \cdot 10^3$	-	$7.07 \cdot 10^3$	-

Table 31  
Class E1 – Non-bending mode (indicated for right-hand traffic)

Element	Angular coordinates in deg.		Luminous intensity in cd					
			Column A		Column B		Column C	
	vertical	horizontal	± 0% CoP		± 20% CoP		± 30% CoP	
			min	max	min	max	min	max
BR	1°U	2.5°R	-	$1.75 \cdot 10^3$	-	$2.10 \cdot 10^3$	-	$2.28 \cdot 10^3$
Point BLL	0.57°U	8°L	-	$8.80 \cdot 10^2$	-	$1.14 \cdot 10^3$	-	$1.26 \cdot 10^3$
B50L	0.57°U	3.43°L	-	$5.30 \cdot 10^2$	-	$7.00 \cdot 10^2$	-	$7.85 \cdot 10^2$
Line III b	0.34°U	4°L to 0.5°L	-	$8.80 \cdot 10^2$	-	$1.14 \cdot 10^3$	-	$1.26 \cdot 10^3$
75R	0.57°D	1.15°R	$1.52 \cdot 10^4$	-	$1.22 \cdot 10^4$	-	$1.06 \cdot 10^4$	-
50L	0.86°D	3.43°L	$6.80 \cdot 10^3$	-	$5.44 \cdot 10^3$	-	$4.76 \cdot 10^3$	-
50V	0.86°D	0°	$1.01 \cdot 10^4$	-	$8.08 \cdot 10^3$	-	$7.07 \cdot 10^3$	-

Table 32  
Class E2 – Non-bending mode (indicated for right-hand traffic)

Element	Angular coordinates in deg.		Luminous intensity in cd					
			Column A		Column B		Column C	
	vertical	horizontal	± 0% CoP		± 20% CoP		± 30% CoP	
			min	max	min	max	min	max
BR	1°U	2.5°R	-	$1.75 \cdot 10^3$	-	$2.10 \cdot 10^3$	-	$2.28 \cdot 10^3$
Point BLL	0.57°U	8°L	-	$8.80 \cdot 10^2$	-	$1.14 \cdot 10^3$	-	$1.26 \cdot 10^3$
B50L	0.57°U	3.43°L	-	$4.40 \cdot 10^2$	--	$6.10 \cdot 10^2$	-	$6.95 \cdot 10^2$
Line III b	0.34°U	4°L to 0.5°L	-	$8.80 \cdot 10^2$	-	$1.14 \cdot 10^3$	-	$1.26 \cdot 10^3$
75R	0.57°D	1.15°R	$1.52 \cdot 10^4$	-	$1.22 \cdot 10^4$	-	$1.06 \cdot 10^4$	-
50L	0.86°D	3.43°L	$6.80 \cdot 10^3$	-	$5.44 \cdot 10^3$	-	$4.76 \cdot 10^3$	-
50V	0.86°D	0°	$1.01 \cdot 10^4$	-	$8.08 \cdot 10^3$	-	$7.07 \cdot 10^3$	-

Table 33  
**Class E3 – Non-bending mode (indicated for right-hand traffic)**

Element	Angular coordinates in deg.		Luminous intensity in cd					
			Column A		Column B		Column C	
	vertical	horizontal	± 0% CoP		± 20% CoP		± 30% CoP	
			min	max	min	max	min	max
BR	1°U	2.5°R	-	1.75·10 <sup>3</sup>	-	2.10·10 <sup>3</sup>	-	2.28·10 <sup>3</sup>
Point BLL	0.57°U	8°L	-	8.80·10 <sup>2</sup>	-	1.14·10 <sup>3</sup>	-	1.26·10 <sup>3</sup>
B50L	0.57°U	3.43°L	-	3.50·10 <sup>2</sup>	-	5.20·10 <sup>2</sup>	-	6.05·10 <sup>2</sup>
Line III b	0.34°U	4°L to 0.5°L	-	8.80·10 <sup>2</sup>	-	1.14·10 <sup>3</sup>	-	1.26·10 <sup>3</sup>
75R	0.57°D	1.15°R	1.52·10 <sup>4</sup>	-	1.22·10 <sup>4</sup>	-	1.06·10 <sup>4</sup>	-
50L	0.86°D	3.43°L	6.80·10 <sup>3</sup>	-	5.44·10 <sup>3</sup>	-	4.76·10 <sup>3</sup>	-
50V	0.86°D	0°	1.01·10 <sup>4</sup>	-	8.08·10 <sup>3</sup>	-	7.07·10 <sup>3</sup>	-

6.2.1.1.4.2. Driving-beam Photometric Requirements

6.2.1.1.4.2.1. Driving-beam – Neutral State

If there is more than one mode of the driving-beam only the mode corresponding to the neutral state shall be tested for CoP according to Table 34.

6.2.1.1.4.2.1.1. Driving-beam –bending mode –if applicable:

If the system uses the same functional units to obtain bending modes for more than one class, no further testing of the bending modes of Category 1 and/or Category 2 is necessary

If not, the system shall be tested according to Table 35.

6.2.1.1.4.2.2. Adaptive Driving-beam–if applicable:

During adaptation, the driving-beam function shall meet the requirements for all the cases of Right-Hand and/or Left-Hand traffic specified in Part A of Table 36

If the system uses the same functional units for the adaptation of the driving-beam only Line 1 and Line 4 of Table 36 have to be measured.

In the case where the passing-beam, which meets the requirements of paragraph 6.2.1.1.4.1. is continuously operated in conjunction with the adaptation of the driving-beam, the photometric requirements in Part B of Table 36 shall not be applied.

Table 34  
**Class R – Driving – Neutral State – System Requirements**

Element	Angular coordinates in deg.		Luminous intensity in cd					
			Column A		Column B		Column C	
	vertical	horizontal	± 0% CoP		± 20% CoP		± 30% CoP	
			min	max	min	max	min	max
2U-V	2°U	0°	1.70·10 <sup>3</sup>	2.15·10 <sup>5</sup>	1.30·10 <sup>3</sup>	2.58·10 <sup>5</sup>	1.10·10 <sup>3</sup>	2.80·10 <sup>5</sup>
H-12L	0°	12°L	1.50·10 <sup>3</sup>		1.20·10 <sup>3</sup>		1.00·10 <sup>3</sup>	
H-9L	0°	9°L	3.40·10 <sup>3</sup>		2.70·10 <sup>3</sup>		2.30·10 <sup>3</sup>	
H-6L	0°	6°L	5.00·10 <sup>3</sup>		4.00·10 <sup>3</sup>		3.50·10 <sup>3</sup>	
H-3L	0°	3°L	1.75·10 <sup>4</sup>		1.40·10 <sup>4</sup>		1.22·10 <sup>4</sup>	
H-V	0°	0°	3.20·10 <sup>4</sup>		2.56·10 <sup>4</sup>		2.24·10 <sup>4</sup>	
H-3R	0°	3°R	1.75·10 <sup>4</sup>		1.40·10 <sup>4</sup>		1.22·10 <sup>4</sup>	
H-6R	0°	6°R	5.00·10 <sup>3</sup>		4.00·10 <sup>3</sup>		3.50·10 <sup>3</sup>	
H-9R	0°	9°R	3.40·10 <sup>3</sup>		2.70·10 <sup>3</sup>		2.30·10 <sup>3</sup>	

H-12R	0°	12°R	1.50·10 <sup>3</sup>		1.20·10 <sup>3</sup>		1.00·10 <sup>3</sup>	
-------	----	------	----------------------	--	----------------------	--	----------------------	--

Table 35  
Class R – Driving-beam Bend lighting – System Requirements

Element	Angular coordinates in deg.		Luminous intensity in cd					
			Column A		Column B		Column C	
	vertical	horizontal	± 0% CoP		± 20% CoP		± 30% CoP	
			min	max	min	max	min	max
2U-V	2°U	0°	1.30·10 <sup>3</sup>	2.15·10 <sup>5</sup>	1.08·10 <sup>3</sup>	2.58·10 <sup>5</sup>	9.50·10 <sup>2</sup>	2.80·10 <sup>5</sup>
H-12L	0°	12°L	1.20·10 <sup>3</sup>		9.60·10 <sup>2</sup>		8.40·10 <sup>2</sup>	
H-9L	0°	9°L	2.70·10 <sup>3</sup>		2.17·10 <sup>3</sup>		1.90·10 <sup>3</sup>	
H-6L	0°	6°L	4.00·10 <sup>3</sup>		3.20·10 <sup>3</sup>		2.80·10 <sup>3</sup>	
H-3L	0°	3°L	1.40·10 <sup>4</sup>		1.12·10 <sup>4</sup>		9.80·10 <sup>3</sup>	
H-V	0°	0°	3.20·10 <sup>4</sup>		2.56·10 <sup>4</sup>		2.24·10 <sup>4</sup>	
H-3R	0°	3°R	1.40·10 <sup>4</sup>		1.12·10 <sup>4</sup>		9.80·10 <sup>3</sup>	
H-6R	0°	6°R	4.00·10 <sup>3</sup>		3.20·10 <sup>3</sup>		2.80·10 <sup>3</sup>	
H-9R	0°	9°R	2.70·10 <sup>3</sup>		2.17·10 <sup>3</sup>		1.90·10 <sup>3</sup>	
H-12R	0°	12°R	1.20·10 <sup>3</sup>		9.60·10 <sup>2</sup>		8.40·10 <sup>2</sup>	

Table 36  
Class R – Adaptive Driving-beam – System Requirements

	Element	Angular coordinates in deg		Max. luminous intensity <sup>b</sup> in cd		
		vertical	horizontal	Column A	Column B	Column C
				± 0% CoP	± 20% CoP	± 30% CoP
Part A	Line 1 Left Oncoming vehicle at 50 m in the case of Right-Hand Traffic	0.57°U	4.8°L to 2°L	6.25·10 <sup>2</sup>	8.80·10 <sup>2</sup>	1.00·10 <sup>3</sup>
	Line 1 Right Oncoming vehicle at 50 m in the case of Left-Hand Traffic	0.57°U	2°R to 4.8°R	6.25·10 <sup>2</sup>	8.80·10 <sup>2</sup>	1.00·10 <sup>3</sup>
	Line 2 Left Oncoming vehicle at 100 m in the case of Right-Hand Traffic	0.3°U	2.4°L to 1°L	1.75·10 <sup>3</sup>	2.10·10 <sup>3</sup>	2.28·10 <sup>3</sup>
	Line 2 Right Oncoming vehicle at 100 m in the case of Left-Hand Traffic	0.3°U	1°R to 2.4°R	1.75·10 <sup>3</sup>	2.10·10 <sup>3</sup>	2.28·10 <sup>3</sup>
	Line 3 Left Oncoming vehicle at 200 m in the case of Right-Hand Traffic	0.15°U	1.2°L to 0.5°L	5.45·10 <sup>3</sup>	6.54·10 <sup>3</sup>	7.09·10 <sup>3</sup>
	Line 3 Right Oncoming vehicle at 200 m in the case of Left-Hand Traffic	0.15°U	0.5°R to 1.2°R	5.45·10 <sup>3</sup>	6.54·10 <sup>3</sup>	7.09·10 <sup>3</sup>
	Line 4 Preceding vehicle at 50 m in the case of Right-Hand Traffic	0.3°U	1.7°L to 1.0°R	1.85·10 <sup>3</sup>	2.22·10 <sup>3</sup>	2.41·10 <sup>3</sup>
			> 1.0°R to 1.7°R	2.50·10 <sup>3</sup>	3.00·10 <sup>3</sup>	3.25·10 <sup>3</sup>
	Line 4 Preceding vehicle at 50 m in the case of Left-Hand Traffic	0.3°U	1.7°R to 1.0°L	1.85·10 <sup>3</sup>	2.22·10 <sup>3</sup>	2.41·10 <sup>3</sup>
			> 1.0°L to 1.7°L	2.50·10 <sup>3</sup>	3.00·10 <sup>3</sup>	3.25·10 <sup>3</sup>
	Line 5 Preceding vehicle at 100 m in the case of Right-Hand Traffic	0.15°U	0.9°L to 0.5°R	5.30·10 <sup>3</sup>	6.36·10 <sup>3</sup>	6.89·10 <sup>3</sup>
			> 0.5°R to 0.9°R	7.00·10 <sup>3</sup>	8.40·10 <sup>3</sup>	9.10·10 <sup>3</sup>
	Line 5 Preceding vehicle at 100 m in the case of Left-Hand Traffic		0.9°R to 0.5°L	5.30·10 <sup>3</sup>	6.36·10 <sup>3</sup>	6.89·10 <sup>3</sup>
		0.15°U	> 0.5°L to 0.9°L	7.00·10 <sup>3</sup>	8.40·10 <sup>3</sup>	9.10·10 <sup>3</sup>
Line 6 Preceding vehicle at 200 m in the case of Left-Hand Traffic and Right-Hand Traffic	0.1°U	0.45°L to 0.45°R	1.60·10 <sup>4</sup>	1.92·10 <sup>4</sup>	2.08·10 <sup>4</sup>	

	Element <sup>a</sup>	Angular coordinates in deg.		Max. luminous intensity <sup>b</sup> in cd		
		vertical	horizontal	Column A	Column B	Column C
				± 0% CoP	± 20% CoP	± 30% CoP
Part B	50L	0.86°D	3.43°L	2.55·10 <sup>3</sup>	2.04·10 <sup>3</sup>	1.79·10 <sup>3</sup>
	50V	0.86°D	0°	5.10·10 <sup>3</sup>	4.08·10 <sup>3</sup>	3.57·10 <sup>3</sup>
	50R	0.86°D	1.72°R	5.10·10 <sup>3</sup>	4.08·10 <sup>3</sup>	3.57·10 <sup>3</sup>
	25LL	1.72°D	16°L	1.18·10 <sup>3</sup>	9.44·10 <sup>2</sup>	8.26·10 <sup>2</sup>
	25RR	1.72°D	11°R	1.18·10 <sup>3</sup>	9.44·10 <sup>2</sup>	8.26·10 <sup>2</sup>

Notes: In the Table 36

<sup>a</sup> Angular positions are indicated for right-hand traffic.

<sup>b</sup> The photometric requirements for each single measuring point (angular position) of this lighting function apply to half of the sum of the respective measured values from all lighting units of the system applied for this function.

Each of the lines defined in part A of Table 36, in conjunction with the test points as prescribed in part B of Table 36 shall be measured individually corresponding to the signal provided by the signal generator.

In the case where the passing-beam, which meets the requirements of paragraph 6.2.1.1.4.1, is continuously operated in conjunction with the adaptation of the driving-beam, the photometric requirements in Part B of Table 36 shall not be applied.

6.2.1.1.4.3. If the results of the test described above do not meet the requirements, the alignment of the AFS may be changed according to the provisions in Annex 5, paragraph 4.1.

6.2.1.1.4.4. As an alternative to the re-alignment procedure as described in paragraph 4.1. of Annex 5, the intensity requirement of column A, B or C of Tables 23 to 38 for a particular direction of observation shall be deemed to be satisfied if that requirement is met in a direction deviating by not more than one-quarter of a degree from the direction of observation.

6.3. With respect to the verification of the change in vertical position of the cut-off line under the influence of heat, the following procedure shall be applied:

One of the sampled lamps or systems shall be tested according to the procedure described in paragraph 3.1. of Annex 7 after being subjected three consecutive times to the cycle described in paragraph 3.2.2. of Annex 7

A headlamp or system shall be considered as acceptable if  $\Delta r$  does not exceed 1.5 mrad upwards and does not exceed 2.5 mrad downwards.

If this value exceeds 1.5 mrad but is not more than 2.0 mrad upwards or exceeds 2.5 mrad but is not more than 3.0 mrad downwards, a second sample shall be subjected to the test after which the mean of the absolute values recorded on both samples shall not exceed 1.5 mrad upwards and shall not exceed 2.5 mrad downwards.

However, if this value of 1.5 mrad upwards and 2.5 mrad downwards on these two systems is not complied with, another two systems shall be subjected to the same procedure and the value of  $\Delta r$  for each of them shall not exceed 1.5 mrad upwards and shall not exceed 2.5 mrad downwards.

A front fog lamp shall be considered as acceptable if  $\Delta r$  does not exceed 3.0 mrad. If this value exceeds 3.0 mrad but is not more than 4.0 mrad, a second front fog lamp shall be subjected to the test after which the mean of the absolute values recorded on both samples shall not exceed 3.0 mrad.

6.4. The chromaticity coordinates shall be complied with.

## 7. Transitional provisions

7.1. General

7.1.1. Contracting Parties applying this Regulation shall continue to accept type approvals of the lamps (functions), to any of the preceding series of amendments to this Regulation, which are not affected by the changes introduced by the latest series of amendments.

To verify this, the change index applicable to the pertinent lamp (function) shall not differ from its change index as indicated in the latest series of amendments.

7.1.2. Contracting Parties applying this Regulation shall not refuse to grant extensions to type approvals according to any preceding series of amendments to this Regulation.

7.2. For the 01 series of amendments

7.2.1. As from the official date of entry into force of the 01 series of amendments, no Contracting Party applying this Regulation shall refuse to grant or refuse to accept UN type approvals under this Regulation as amended by the 01 series of amendments.

- 7.2.2. As from 1 September [2026] Contracting Parties applying this Regulation shall not be obliged to accept UN type approvals to the preceding series of amendments, first issued after 1 September [2026].
- 7.2.3. Contracting Parties applying this Regulation shall continue to accept type approvals to the preceding series of amendments to this Regulation, first issued before 1 September [2026].
- 7.2.4. Contracting Parties applying this Regulation shall continue to grant and accept type approvals for devices (equipment and parts) on the basis of any previous series of amendments, provided that the devices (equipment and parts) are intended as replacements for fitting to vehicles in use and that it is not technically feasible for the devices (equipment and parts) in question to satisfy the new requirements contained in this Regulation as amended by the 01 series of amendments.
- 7.2.5. Notwithstanding the transitional provisions above, Contracting Parties whose application of this Regulation comes into force after the date of entry into force of the 01 series of amendments are not obliged to accept UN type approvals which were granted in accordance with any of the preceding series of amendments to this Regulation.
- 7.2.6. Contracting Parties applying this Regulation shall continue to accept UN type approvals to the preceding series of amendments to this Regulation, for the equipment or parts which are not affected by the changes introduced by the 01 series of amendments.
- 7.2.7. Contracting Parties applying this Regulation shall not refuse to grant type approvals according to any preceding series of amendments to this Regulation or extensions thereof.

# Annex 1

## Communication

(Maximum format: A4 (210 x 297 mm))



issued by: Name of administration:  
 .....  
 .....  
 .....

Concerning:<sup>2</sup> Approval granted  
 Approval extended  
 Approval refused  
 Approval withdrawn  
 Production definitively discontinued

of a type of device or system pursuant to UN Regulation No. 149

Class of the lamp (function): ..... Change index: .....

Approval No. ....

Unique Identifier (UI) (If applicable): ... ..

1. Trade name or mark of the device or system: .....
2. Manufacturer's name for the type of device or system: .....
3. Manufacturer's name and address: .....
4. If applicable, name and address of manufacturer's representative: .....
5. Submitted for approval on: .....
6. Technical Service responsible for conducting approval tests: .....
7. Date of report issued by that service: .....
8. Number of report issued by that service: .....
9. Brief description:
  - 9.1. For passing-beam headlamps of Classes C and V and driving-beam headlamps of Classes A, B and RA
 

The driving-beam of Class RA (auxiliary driving-beam) shall only be operated together with driving-beams of Classes A, B or AFS-R .
  - 9.1.1. Class(es) as described by the relevant marking:<sup>3</sup> .....

<sup>1</sup> Distinguishing number of the country which has granted/extended/refused/withdrawn approval (see approval provisions in the regulation).

<sup>2</sup> Strike out what does not apply.

<sup>3</sup> Indicate the appropriate marking(s) based on the symbols listed on Table 1 combined with the relevant additional symbol(s) described in paragraph 3.3.2.4. if any (examples are provided in Annex 13).



- 9.1.1.1. Matched pair: yes/no<sup>2</sup>
- 9.1.2. Number, category and kind of light source(s): .....  
 Lamp approved for LED substitute light source(s): yes/no<sup>2</sup>.....  
 If yes, category of LED substitute light source(s): .....  
 Rated voltage or range of voltage: .....
- 9.1.3. Reference luminous flux used for the principal passing-beam (lm):.....
- 9.1.4. Principal passing-beam operated at approximately (V): .....
- 9.1.5. Measures according to paragraph 4.12. of this Regulation: .....
- 9.1.6. Number and specific identification code(s) of light source module(s) and for each light source module a statement whether it is replaceable or not: yes/no<sup>2</sup> .....
- 9.1.7. Number and specific identification code(s) of electronic light source control gear(s).....
- 9.1.8. Total objective luminous flux as described in paragraph 4.5.3.4. of this Regulation exceeds  $2.00 \cdot 10^3$  lumens: yes/no/does not apply<sup>2</sup>
- 9.1.9. The adjustment of the cut-off has been determined at: 10 m/25 m/does not apply<sup>2</sup>  
 The determination of the minimum sharpness of the "cut-off" has been carried out at: 10 m/25 m/does not apply<sup>2</sup>
- 9.1.10. Trade name and identification number of separate ballast(s) or part(s) of ballast(s) if any:.....
- 9.1.11. The lamp is only intended for installation on vehicles in use: yes/no<sup>2</sup>
- 9.1.12. The light source(s) producing the principal passing beam may be lit simultaneously with that of any other lighting function in the same body: yes/no<sup>2</sup>  
 If yes, the following lighting function(s) are lit simultaneously:.....
- 9.2. For AFS – Systems
- 9.2.1. Class(es) as described by the relevant marking<sup>4</sup> .....
- 9.2.2. Number, category and kind of light source(s) .....  
 Lamp approved for LED substitute light source(s): yes/no<sup>2</sup>.....  
 If yes, category of LED substitute light source(s): .....  
 Rated voltage or range of voltage: .....
- 9.2.2.1. Number and specific identification code(s) of light source module(s) and for each light source module a statement whether it is replaceable or not: yes/no<sup>2</sup>  
 .....
- 9.2.2.2. Number and specific identification code(s) of electronic light source control gear(s), if applicable.....
- 9.2.2.3. Total objective luminous flux as described in paragraph 4.5.3.6. of this Regulation exceeds  $2.00 \cdot 10^3$  lumens: yes/no<sup>2</sup>
- 9.2.3. (a) Indications according to paragraph 5.3.5.1. of this Regulation (which lighting unit(s) provide a "cut-off" as defined in Annex 5 of this Regulation, that projects into a zone extending from 6 degrees left to 4 degrees right and upwards from a horizontal line positioned at 0.8 degree down) .....  
 .....
- (b) The adjustment of the "cut-off" has been determined at 10 m / 25 m.<sup>2</sup>

<sup>4</sup> Indicate the appropriate marking as foreseen according to this Regulation for each installation unit or assembly of installation units.

- (c) The determination of the minimum sharpness of the "cut-off" has been carried out at 10 m / 25 m.<sup>2</sup>
- 9.2.4. The vehicle(s) for which the system is intended as original equipment.....
- 9.2.5. Whether approval is sought for a system which is not intended to be included as part of the approval of a vehicle type according to UN Regulation No. 48: yes/no<sup>2</sup>
- 9.2.5.1. If in the affirmative: information sufficient to identify the vehicle(s) for which the system is intended.....
- 9.2.6. Indications according to paragraph 5.3.5.2. of this Regulation (which class E passing-beam mode(s), if any, comply with a "data set" of Table 12 of this Regulation).....
- 9.2.7. Whether approval is sought for a system intended to be installed on vehicles only, which provide means for a stabilization/limitation of the system's supply: yes/no<sup>2</sup>
- 9.2.8. The adjustment of the "cut-off" has been determined at 10 m / 25 m.<sup>2</sup>  
The determination of the minimum sharpness of the "cut-off" has been carried out at 10 m / 25 m.<sup>2</sup>
- 9.2.9. The system is designed to provide passing-beams of:<sup>5</sup>
- 9.2.9.1. Class C  Class V  Class E  Class W
- 9.2.9.2. With the following mode(s), identified by the designation(s), if it applies<sup>6</sup>  
Mode No. C 1      Mode No. V ...    Mode No. E ...    Mode No. W ...  
Mode No. C ...    Mode No. V ...    Mode No. E ...    Mode No. W ...  
Mode No. C ...    Mode No. V ...    Mode No. E ...    Mode No. W ...
- 9.2.9.3. Where the lighting units indicated below are energized<sup>5,6,7</sup> for the mode No. ....
  - (a) If no bend lighting applies:  
Left side    No.1  No.3  No.5  No.7  No. 9  No.11   
Right side    No.2  No.4  No.6  No.8  No.10  No.12
  - (b) If bend lighting of category 1 applies:  
Left side    No.1  No.3  No.5  No.7  No. 9  No.11   
Right side    No.2  No.4  No.6  No.8  No.10  No.12
  - (c) if bend lighting of category 2 applies:  
Left side    No.1  No.3  No.5  No.7  No. 9  No.11   
Right side    No.2  No.4  No.6  No.8  No.10  No.12

*Note:* Indications according to paragraph (a) through (c) above are needed additionally for each further mode.
- 9.2.9.4. The lighting units marked below are energized, when the system is in its neutral state<sup>5,7</sup>  
Left side            No.1  No.3  No.5  No.7  No. 9  No.11   
Right side            No.2  No.4  No.6  No.8  No.10  No.12
- 9.2.9.5. The lighting units marked below are energized, when the system is in its traffic change function<sup>5,6,7</sup>

<sup>5</sup> Mark with an X where applicable.  
<sup>6</sup> To be extended if more modes are provided.  
<sup>7</sup> To be continued if more units are provided.

- (a) If no bend lighting applies:  
 Left side No.1  No.3  No.5  No.7  No. 9  No.11   
 Right side No.2  No.4  No.6  No.8  No.10  No.12
- (b) If bend lighting of category 1 applies:  
 Left side No.1  No.3  No.5  No.7  No. 9  No.11   
 Right side No.2  No.4  No.6  No.8  No.10  No.12
- (c) If bend lighting of category 2 applies:  
 Left side No.1  No.3  No.5  No.7  No. 9  No.11   
 Right side No.2  No.4  No.6  No.8  No.10  No.12
- 9.2.10. The system is designed to provide a main beam<sup>5,6,7</sup>:
- 9.2.10.1. Yes  No
- 9.2.10.2. With the following mode(s), identified by the designation(s), if it applies:  
 Main beam mode No. M 1  
 Main beam mode No. M ...  
 Main beam mode No. M ...
- 9.2.10.3. Where the lighting units marked below are energized, for mode No. ....
- (a) If no bend lighting applies:  
 Left side No.1  No.3  No.5  No.7  No. 9  No.11   
 Right side No.2  No.4  No.6  No.8  No.10  No.12
- (b) If bend lighting applies:  
 Left side No.1  No.3  No.5  No.7  No. 9  No.11   
 Right side No.2  No.4  No.6  No.8  No.10  No.12
- Note:* Indications according to this paragraph (a) through (b) above are needed additionally for each further mode.
- 9.2.10.4. The lighting units marked below are energized, when the system is in its neutral state<sup>5</sup>
- Left side No.1  No.3  No.5  No.7  No. 9  No.11   
 Right side No.2  No.4  No.6  No.8  No.10  No.12
- 9.2.10.5. The system is designed to provide an adaptation of the driving-beam for:  
 Right-Hand and Left-Hand traffic: yes  no   
 Right-Hand traffic only: yes  no   
 Left-Hand traffic only: yes  no
- 9.2.11. The system is only intended for installation on vehicles in use: yes/no<sup>2</sup>
- 9.2.12. The light source(s) producing the principal passing beam may be lit simultaneously with that of any other lighting function in the same body: yes/no<sup>2</sup>  
 If yes, the following lighting function (s) are lit simultaneously:.....
- 9.2.13. Measures according to paragraph 4.12. of this Regulation: .....
- 9.3. For headlamps of Classes AS, BS, CS and DS
- 9.3.1. Class(es) as described by the relevant marking<sup>3</sup>: .....
- 9.3.1.1. Matched pair: yes/no<sup>2</sup>
- 9.3.2. Number, category and kind of light source(s), if any: .....  
 Lamp approved for LED substitute light source(s): yes/no<sup>2</sup>.....

- If yes, category of LED substitute light source(s): .....
- Rated voltage or range of voltage: .....
- 9.3.3. Number and specific identification code(s) of light source modules and for each light source module a statement whether it is replaceable or not: yes/no<sup>2</sup> .....
- 9.3.4. Number and specific identification code(s) of electronic light source control gear(s), if any: .....
- 9.3.5. The determination of "cut-off" sharpness yes / no<sup>2</sup>  
If yes, it was carried out at 10 m / 25 m.<sup>2</sup> .....
- 9.3.6. Trade name and identification number of separate ballast(s) or part(s) of ballast(s): .....
- 9.3.7. The light source(s) producing the principal passing beam may be lit simultaneously with that of any other lighting function in the same body: yes/no<sup>2</sup>  
If yes, the following lighting function (s) are lit simultaneously:.....
- 9.3.8. The minimum bank angle(s) to satisfy the requirement of paragraph 5.4.4.1., if any .....
- 9.3.9. Driving-beam of Class BS: yes / no<sup>2</sup>  
Secondary Driving-beam of Class CS or Class DS: yes / no<sup>2</sup>  
The Secondary Driving-beam shall only be operated together with a passing-beam or a driving-beam of Class A or Class B.
- 9.3.10. The lamp is only intended for installation on vehicles in use: yes/no<sup>2</sup>
- 9.4. For front fog lamps Class F3
- 9.4.1. Class as described by the relevant marking<sup>3</sup>: .....
- 9.4.1.1. Matched pair: yes/no<sup>2</sup>
- 9.4.2. Number, category and kind of light source(s): .....
- Lamp approved for LED substitute light source(s): yes/no<sup>2</sup>.....
- If yes, category of LED substitute light source(s) .....
- Rated voltage or range of voltage: .....
- 9.4.3. light source module: yes/no<sup>2</sup> and for each light source module a statement whether it is replaceable or not: yes/no<sup>2</sup>
- 9.4.4. light source module specific identification code: .....
- 9.4.5. Number and specific identification code(s) of electronic light source control gear(s).....
- 9.4.6. Colour of light emitted: ..... white/selective yellow<sup>2</sup>
- 9.4.7. Luminous flux of the light source (see paragraph 4.5.3.4. of this Regulation) greater than  $2.00 \cdot 10^3$  lumens: ... yes/no<sup>2</sup>
- 9.4.8. Luminous intensity is variable: ... yes/no<sup>2</sup>
- 9.4.9. The determination of the cut-off gradient (if measured)  
was carried out at ..... 10 m / 25 m<sup>2</sup>
- 9.4.10. The lamp is only intended for installation on vehicles in use: yes/no<sup>2</sup>
- 9.4.11. The light source(s) producing the front fog lamp may be lit simultaneously with that of any other lighting function in the same body: yes/no<sup>2</sup>  
If yes, the following lighting function (s) are lit simultaneously:.....
- 9.5. For cornering lamps

- 9.5.1. Number, category and kind of light source(s):<sup>8</sup>.....  
 Lamp approved for LED substitute light source(s): yes/no<sup>2</sup>.....  
 If yes, category of LED substitute light source(s): .....
- 9.5.2. Rated voltage or the range of voltage: .....
- 9.5.3. Light source module: ..... yes/no<sup>2</sup>
- 9.5.4. Light source module specific identification code:.....
- 9.5.5. Application of an electronic light source control gear:  
 (a) Being part of the lamp..... yes/no<sup>2</sup>  
 (b) Being not part of the lamp ..... yes/no<sup>2</sup>
- 9.5.6. Input voltage supplied by an electronic light source control gear: .....
- 9.5.7. Electronic light source control gear manufacturer and identification number  
 (when the electronic light source control gear is part of the lamp but is not  
 included into the lamp body):
- 9.5.8. Geometrical conditions of installation and relating variations, if any: .....
- 9.5.9. The lamp is only intended for installation on vehicles in use: yes/no<sup>2</sup>
- 9.6. Whether an additional test is conducted according to the paragraph 4.19. of this  
 Regulation: yes/no<sup>2</sup>
10. Position(s) of the approval mark(s) or Unique Identifier(s) (UI)<sup>2</sup>: .....
11. Reason(s) for extension of approval (if applicable): .....
12. Approval granted / extended / refused / withdrawn<sup>2</sup>
13. Place: .....
14. Date: .....
15. Signature: .....
16. The list of documents deposited with the Type Approval Authority, which has  
 granted approval is annexed to this communication and may be obtained on  
 request.

<sup>8</sup> For cornering lamps with non-replaceable light sources indicate the number and total wattage of the light sources used.

## Annex 2

### Minimum requirements for conformity of production control procedures

1. General
  - 1.1. The conformity requirements shall be considered satisfied from a mechanical and a geometric standpoint, in accordance with the requirements of this Regulation, if any, if the differences do not exceed inevitable manufacturing deviations.
  - 1.2. With respect to photometric performances, the conformity of mass-produced lamps shall not be contested if, when testing photometric performances of any lamp chosen at random and equipped with a standard (étalon) light source and/or non-replaceable light source(s) and/or light source module(s), as present in the lamp:
    - (a) No measured value deviates from the values prescribed in paragraph 6 of this Regulation;
    - (b) If, in the case of a lamp equipped with a replaceable light source and if results of the test described above do not meet the requirements, tests on lamps shall be repeated using another standard light source.
  - 1.3. If the results of the test described above do not meet the requirements, the alignment of the lamp may be changed according to the provisions in Annex 5, paragraph 4.1..
  - 1.4. For AFS corresponding to paragraph 5.3. of this Regulation, if the results of the test described above do not meet the requirements, the alignment of the system may be changed in each class according to the provisions in Annex 5, paragraph 4.1..  
 These provisions do not apply to lighting units as indicated under paragraph 5.3.3.1.1. of this Regulation.
  - 1.5. Lamps with apparent defects are disregarded.
2. Minimum requirements for verification of conformity by the manufacturer
 

For each type of lamp the holder of the approval mark shall carry out at least the following tests, at appropriate intervals. The tests shall be carried out in accordance with the provisions of this Regulation.

If any sampling shows non-conformity with regard to the type of test concerned, further samples shall be taken and tested. The manufacturer shall take steps to ensure the conformity of the production concerned.

  - 2.1. Nature of tests
 

Tests of conformity in this Regulation shall cover the photometric and colorimetric characteristics and the verification of the change in vertical position of the cut-off line under the influence of heat.
  - 2.2. Methods used in tests
    - 2.2.1. Tests shall generally be carried out in accordance with the methods set out in this Regulation.
    - 2.2.2. In any test of conformity carried out by the manufacturer, equivalent methods may be used with the consent of the competent authority responsible for approval tests. The manufacturer is responsible for proving that the applied methods are equivalent to those laid down in this Regulation.

- 2.2.3. The application of paragraphs 2.2.1. and 2.2.2. requires regular calibration of test apparatus and its correlation with measurements made by a competent authority.
- 2.2.4. In all cases the reference methods shall be those of this Regulation, particularly for the purpose of administrative verification and sampling.
- 2.3. Nature of sampling
- Samples of lamps shall be selected at random from the production of a uniform batch. A uniform batch means a set of lamps of the same type, defined according to the production methods of the manufacturer.
- The assessment shall in general cover series production from individual factories. However, a manufacturer may group together records concerning the same type from several factories, provided these operate under the same quality system and quality management.
- 2.4. Measured and recorded photometric characteristics
- 2.4.1. The sampled devices shall be subjected to photometric measurements at the points provided for in the Regulation, the reading being limited:
- 2.4.1.1. For driving-beam headlamps of Classes A and B according to paragraph 5.1. and / or passing-beam headlamps (asymmetrical) of Classes C, V and AFS according to paragraphs 5.2. and 5.3 of this Regulation to the points  $I_{\max}$ , HV<sup>1</sup>, H-3L, H-3R in the case of a driving-beam, and to points B50L (or R), 50L (or R), 50V, 75R (or L) if applicable and 40R (or L) in the case of the passing-beam(s).
- 2.4.1.2. For driving-beam headlamps of Classes BS, CS and DS according to paragraph 5.1. and / or passing-beam headlamps (symmetrical cut-off) according to paragraph 5.4. of this Regulation:
- 2.4.1.2.1. For Class AS headlamps to the points HV, 3.43°D/5°L and 3.43°D/5°R.
- 2.4.1.2.2. For Class BS headlamps to the points  $I_{\max}$  and HV<sup>1</sup> in the case of the driving-beam, and to the points HV, 0.86°D/2.5°R, 0.86°D/2.5°L in the case of the passing-beam.
- 2.4.1.2.3. For Classes CS and DS headlamps to the points  $I_{\max}$  and HV in the case of the driving-beam, and to the point 0.86°D/V in the case of the passing-beam.
- 2.4.1.3. For front fog lamps according to paragraph 5.5. of this Regulation, to the points 8 and 9, and the lines 1, 5, 6, 8 and 9 as specified in Table 19.
- 2.4.2. For cornering lamps according to paragraph 5.6. of this Regulation, to the points P1, P2 and P3 as specified in Table 18 and the required chromaticity coordinates.
- 2.5. Criteria governing acceptability
- The manufacturer is responsible for carrying out a statistical study of the test results and for defining, in agreement with the competent authority, criteria governing the acceptability of his products in order to meet the requirements laid down for verification of conformity of products in paragraph 3.5.1. of this Regulation.
- The criteria governing the acceptability shall be such that with a confidence level of 95% the minimum probability of passing a spot check in accordance with Annex 3 (first sampling) would be 0.95.

<sup>1</sup> When the driving-beam is reciprocally incorporated with the passing-beam, HV in the case of the driving-beam shall be the same measuring point as in the case of the passing-beam.

## Annex 3

### Minimum requirements for sampling by an inspector

1. General
  - 1.1. The conformity requirements shall be considered satisfied from a mechanical and a geometric standpoint, in accordance with the requirements of this Regulation, if any, if the differences do not exceed inevitable manufacturing deviations.
  - 1.2. With respect to photometric performance, the conformity of mass-produced lamps shall not be contested if, when testing the photometric performances of any lamp chosen at random, and equipped with a standard (étalon) light source and/or non-replaceable light source(s) and/or light source module(s), as present in the lamp:
    - (a) No measured value deviates from the values prescribed in paragraph 6 of this Regulation;
    - (b) If, in the case of a lamp equipped with a replaceable light source and if results of the test described above do not meet the requirements, tests on lamps shall be repeated using another standard light source.
  - 1.3. Lamps with apparent defects are disregarded.
2. First sampling
 

In the first sampling four lamps are selected at random. The first sample of two is marked A, the second sample of two is marked B.

  - 2.1. The conformity of mass-produced lamps shall not be contested if the deviation of any specimen of samples A and B (all four lamps) is not more than 20 per cent.
 

In the case, that the deviation of both lamps of sample A is not more than 0 per cent the measurement can be closed.
  - 2.2. The conformity of mass-produced lamps shall be contested if the deviation of at least one specimen of samples A or B is more than 20 per cent.
 

The manufacturer shall be requested to bring his production in line with the requirements (alignment) and a repeated sampling according to paragraph 3. shall be carried out within two months' time after the notification. The samples A and B shall be retained by the Technical Service until the entire COP process is finished.
3. First repeated sampling
 

A sample of four lamps is selected at random from stock manufactured after alignment.

The first sample of two is marked C, the second sample of two is marked D.

  - 3.1. The conformity of mass-produced lamps is shall not be contested if the deviation of any specimen of samples C and D (all four lamps) is not more than 20 per cent.
 

In the case that the deviation of both lamps of sample C is not more than 0 per cent the measurement can be closed.
  - 3.2. The conformity of mass-produced lamps shall be contested if the deviation of at least:
    - 3.2.1. One specimen of samples C or D is more than 20 per cent but the deviation of all specimen of these samples is not more than 30 per cent.



The manufacturer shall be requested again to bring his production in line with the requirements (alignment).

A second repeated sampling according to paragraph 4. shall be carried out within two months' time after the notification. The samples C and D shall be retained by the Technical Service until the entire COP process is finished.

3.2.2. One specimen of samples C or D is more than 30 per cent.

In this case the approval shall be withdrawn and paragraph 5. shall be applied.

4. Second repeated sampling

A sample of four lamps is selected at random from stock manufactured after alignment.

The first sample of two is marked E, the second sample of two is marked F.

4.1. The conformity of mass-produced lamps shall not be contested if the deviation of any specimen of samples E and F (all four lamps) is not more than 20 per cent.

In the case that the deviation of both lamps of sample E is not more than 0 per cent the measurement can be closed.

4.2. The conformity of mass-produced lamps shall be contested if the deviation of at least one specimen of samples E or F is more than 20 per cent.

In this case the approval shall be withdrawn and paragraph 5 shall be applied.

5. Approval withdrawn

Approval shall be withdrawn according to paragraph 3.6. of this Regulation.

6. Change of the vertical position of the cut-off line for passing-beam

With respect to the verification of the change in vertical position of the cut-off line for passing-beam under the influence of heat, the following procedure shall be applied:

One of the lamps or system of sample A shall be tested according to the procedure described in paragraph 3. of Annex 7 after being subjected three consecutive times to the cycle described in paragraph 3.2.2. of Annex 7.

The passing-beam or the system shall be considered as acceptable if  $\Delta r$  does not exceed 1.5 mrad upwards and does not exceed 2.5 mrad downwards.

If this value exceeds 1.5 mrad but is not more than 2.0 mrad upwards or exceeds 2.5 mrad but is not more than 3.0 mrad downwards, a second system of sample A shall be subjected to the test after which the mean of the absolute values recorded on both samples shall not exceed 1.5 mrad upwards and shall not exceed 2.5 mrad downwards.

However, if this value of 1.5 mrad upwards and 2.5 mrad downwards on sample A is not complied with, another two systems of sample B shall be subjected to the same procedure and the value of  $\Delta r$  for each of them shall not exceed 1.5 mrad upwards and shall not exceed 2.5 mrad downwards.

In the case of front fog lamps in accordance with paragraph 5.5. to this Regulation the lamp shall be considered as acceptable if  $r$  does not exceed 3.0 mrad.

If this value exceeds 3.0 mrad but is not more than 4.0 mrad, the second front fog lamp of sample A shall be subjected to the test after which the mean of the absolute values recorded in both samples shall not exceed 3.0 mrad.

However, if this value of 3.0 mrad on sample A is not complied with, the two front fog lamps of sample B shall be subjected to the same procedure and the value of  $r$  for each of them shall not exceed 3.0 mrad.

## Annex 4

## Spherical coordinate measuring system and test point locations

Figure A4-I  
Spherical coordinate measuring system

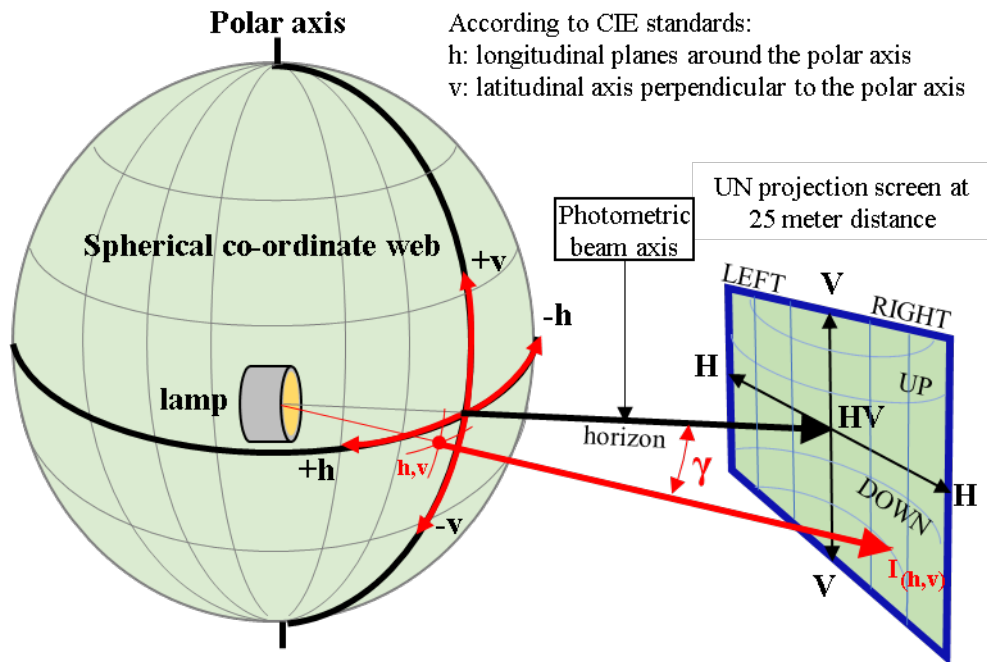

$$E_{25m} = I_{(h,v)} \times \cos \gamma / r^2$$

1. Photometric measurement provisions
  - 1.1. The device or part(s) thereof shall be mounted on a goniometer with a fixed horizontal axis and moveable axis perpendicular to the fixed horizontal axis.
    - 1.1.1. The luminous intensity values shall be determined by means of a photoreceptor contained within a square of 65 mm side and, except for cornering lamps, set up to a distance of at least 25 m forward of the centre of reference of each headlamp or lighting unit perpendicular to the measurement axis from the origin of the goniometer. The point HV is the centre-point of the coordinate system with a vertical polar axis. Line h is the horizontal through HV (see Figure A4-I).
    - 1.1.2. The angular co-ordinates are specified in deg on a sphere with a vertical polar axis according to the gonio-photometer as defined in Figure A4-I.
    - 1.1.3. During photometric measurements, stray reflections should be avoided by appropriate masking.
  - 1.2. Any equivalent photometric method is acceptable, if the accordingly applicable correlation is observed.
  - 1.3. An aiming screen shall be used and may be located at a shorter distance than that of the photoreceptor.
  - 1.4. Before starting the measurements, the device or part(s) thereof shall be aimed as described in Annex 5.

- 1.5. Upon request of the applicant, in case of a matched pair of lamps the photometric requirements for each single measuring point, segment or zone (angular position) apply to half of the sum of the respective measured values from both lamps together.
- 1.5.1. However, in the cases described in paragraph 5.1.4.2. of this Regulation and the footnotes of Tables 5, 6, 14, 15, 16, 17 and 19 where a provision is specified for one side only, the division by the factor of 2 does not apply.
- 1.6. In case of AFS (paragraph 5.3.):
- 1.6.1. Any offset of the centre of reference of each lighting unit, with respect to the goniometer rotation axes, should be avoided. This applies especially to the vertical direction and to lighting units producing a "cut-off".
- 1.6.2. The photometric requirements for each single measuring point or segment (angular position) of a lighting function or mode as specified in this Regulation apply to half of the sum of the respective measured values from each lamp, from all lighting units of the system applied for this function or mode;
- 1.6.2.1. However, in those cases where a provision is specified for one side only, the division by the factor of 2 does not apply. These cases are: paragraphs 5.3.2.5.2., 5.3.2.8.1., 5.1.4.2., 5.3.3.4., 5.3.5.1. of this Regulation, and notes 1 and 7 of Table 7.
- 1.6.3. The lighting units of the system shall be measured individually; however, simultaneous measurements may be performed on two or more lighting units of an installation unit, being equipped with the same light source types with respect to their power supply (either power controlled or not), if they are sized and situated such, that their illuminating surfaces are completely contained in a rectangle of not more than 300 mm in horizontal extend and not more than 150 mm vertical extend, and, if a common centre of reference is specified by the manufacturer.
- 1.6.4. The system shall prior to the subsequent test procedures be set to the neutral state.
- 1.6.5. The system or part(s) thereof shall be so aimed before starting the measurements that the position of the "cut-off" complies with the requirements indicated in the Table 8. Parts of a system measured individually and having no "cut-off" shall be installed on the goniometer under the conditions (mounting position) specified by the applicant.
- 1.7. In case of Cornering lamps
- 1.7.1. In the event that the results of measurements are challenged, measurements shall be taken in such a way as to meet the following requirements:
- 1.7.1.1. The distance of measurement shall be such that the law of the inverse of the square of the distance is applicable;
- 1.7.1.2. The measuring equipment shall be such that the angle subtended by the receiver from the reference centre of the light is between 10' and 1°;
2. Test point locations
- The Figures provided in this Annex are intended for information only. The requirements for the coordinates are indicated in paragraph 5. of this Regulation.
- H-H is the horizontal plane while V-V is the vertical plane passing through the optical axis of the headlamp.
- For the purpose of the Figures in this Annex, angular positions are indicated for right-hand traffic.
- For asymmetric passing-beams the test point locations for left-hand traffic are mirrored about the V-V line

Figure A4-II  
Driving-beam test points

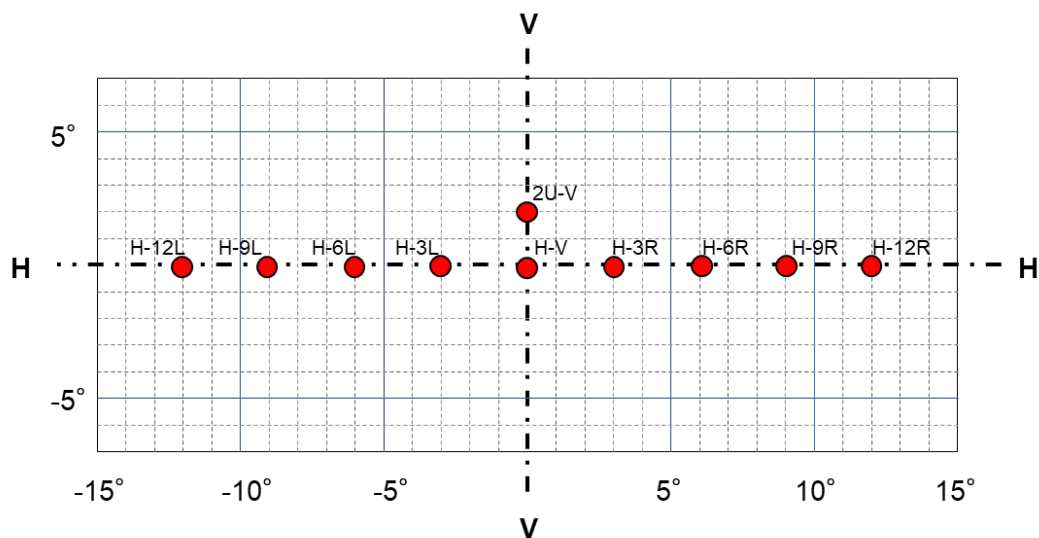

Figure A4-III  
Driving-beam Class BS - position of test points

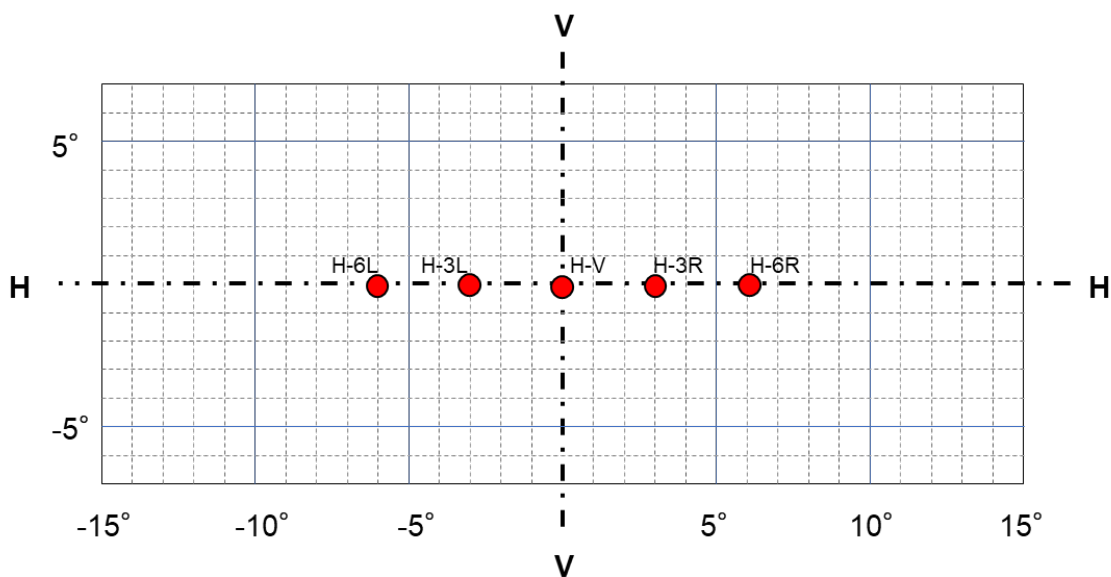

Figure A4-IV  
Secondary driving-beam Class CS and DS - position of test points

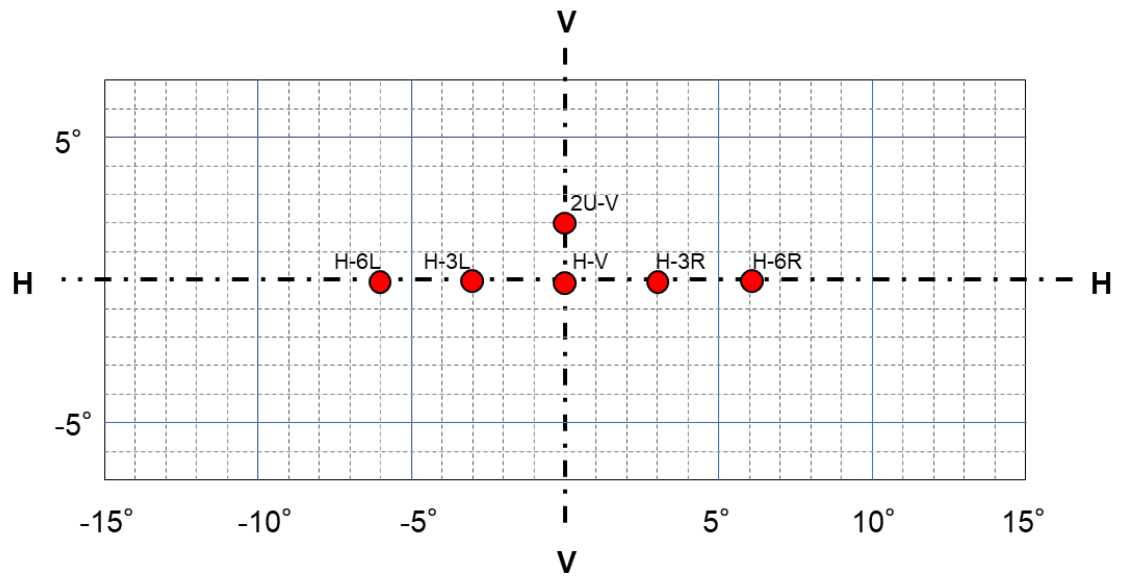

Figure A4-V  
 Classes C and V Passing-beams for right-hand traffic

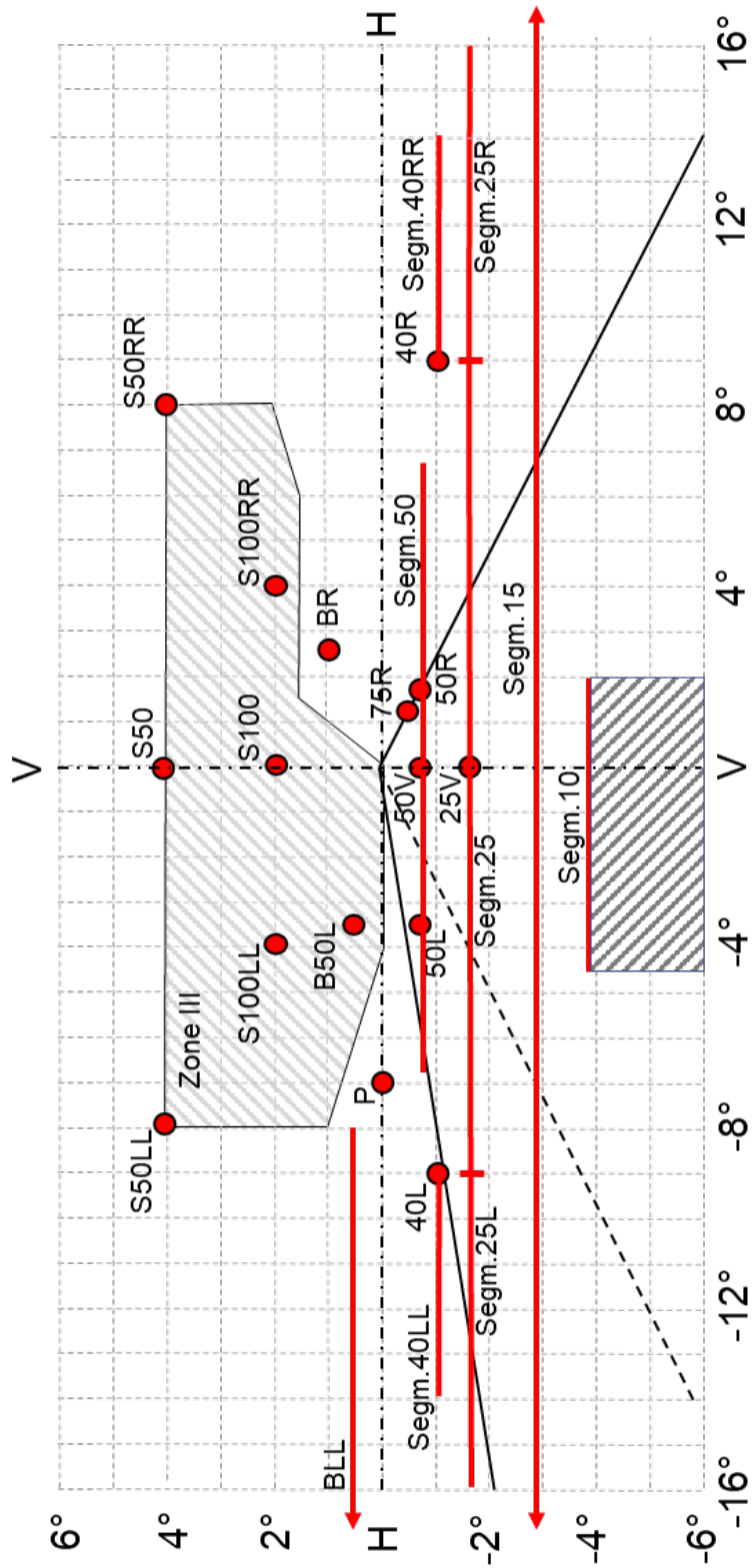

Figure A4-VI  
AFS Passing-beam for right-hand traffic

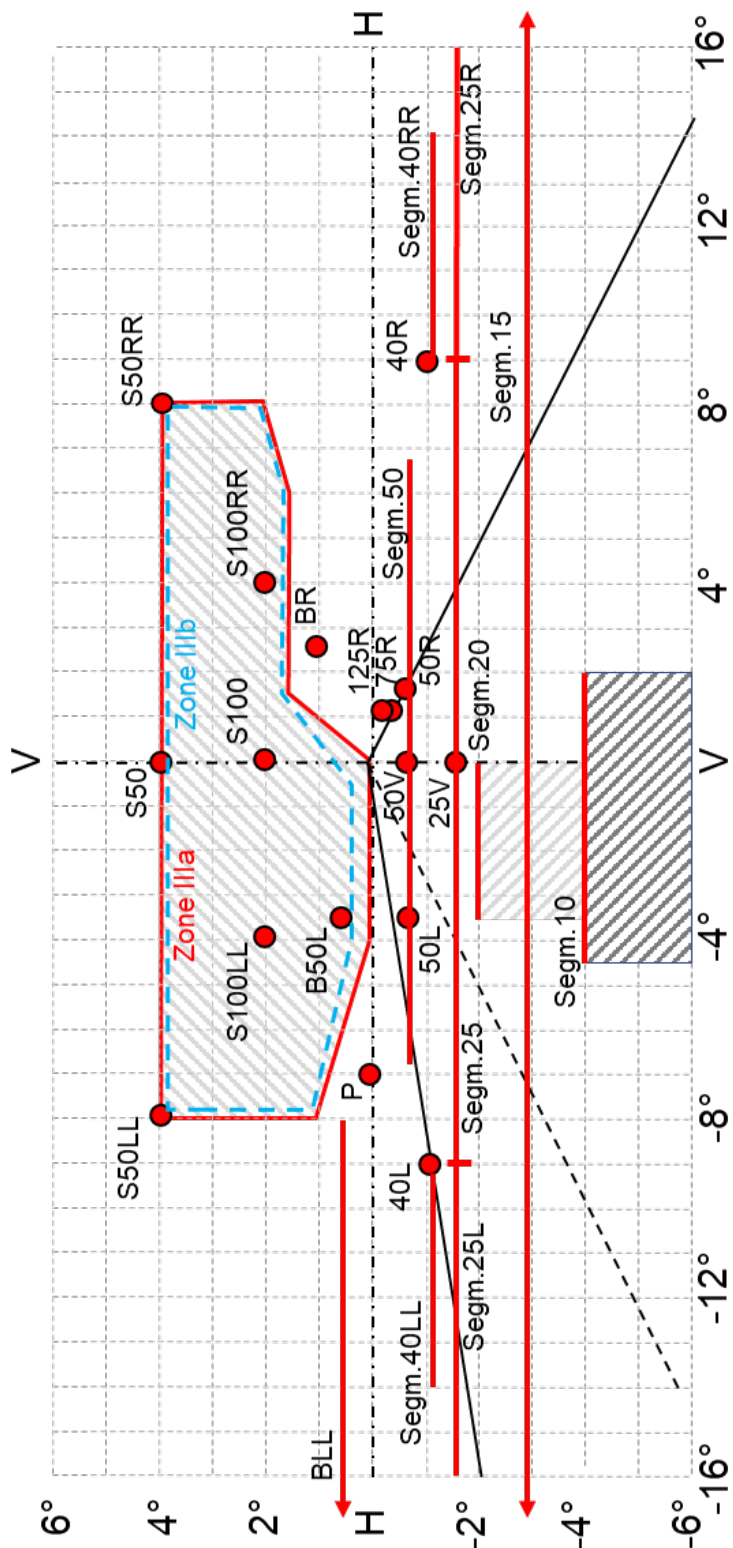

Figure A4-VII  
 Passing-beam test points and zones for Class AS headlamp(s)

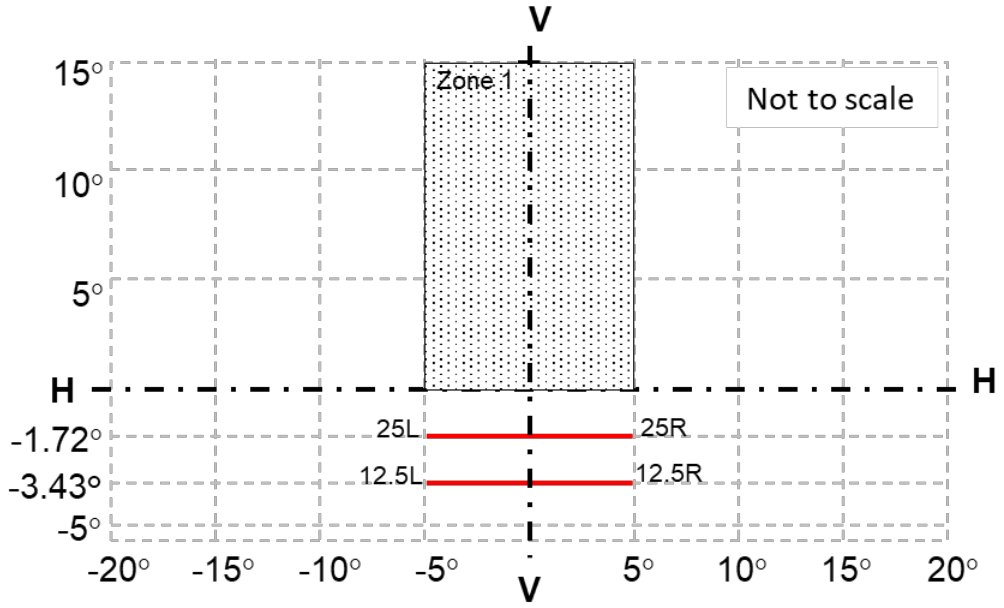

Figure A4-VIII  
 Passing-beam test points and zones for Class BS headlamp(s)

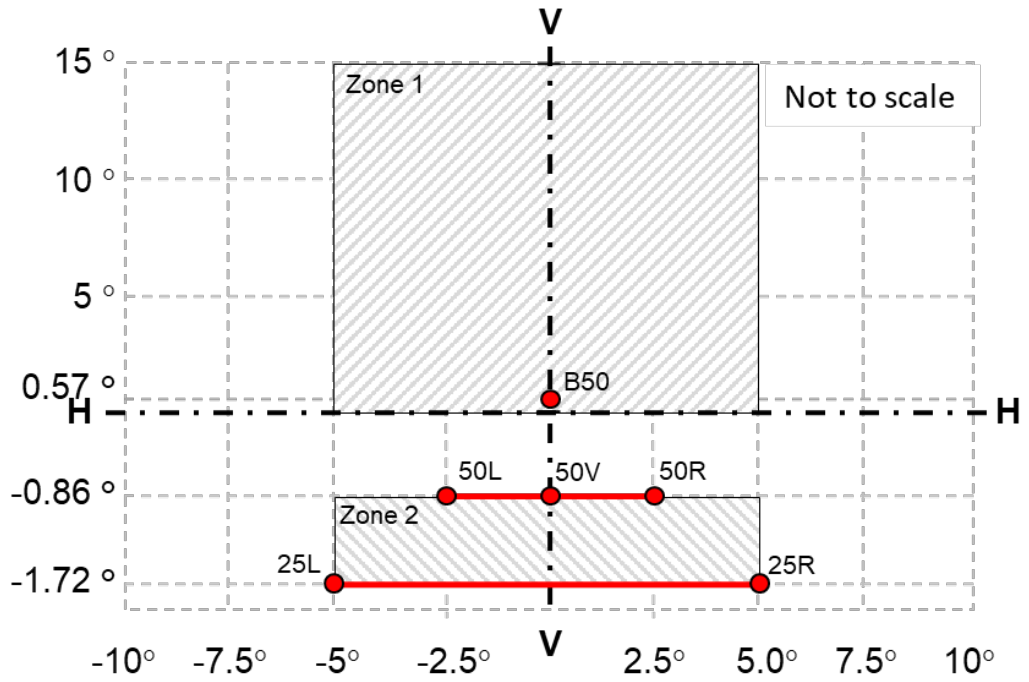



Figure A4-IX  
**Passing-beam - position of test points and zones for Classes CS and DS  
 headlamp(s)**

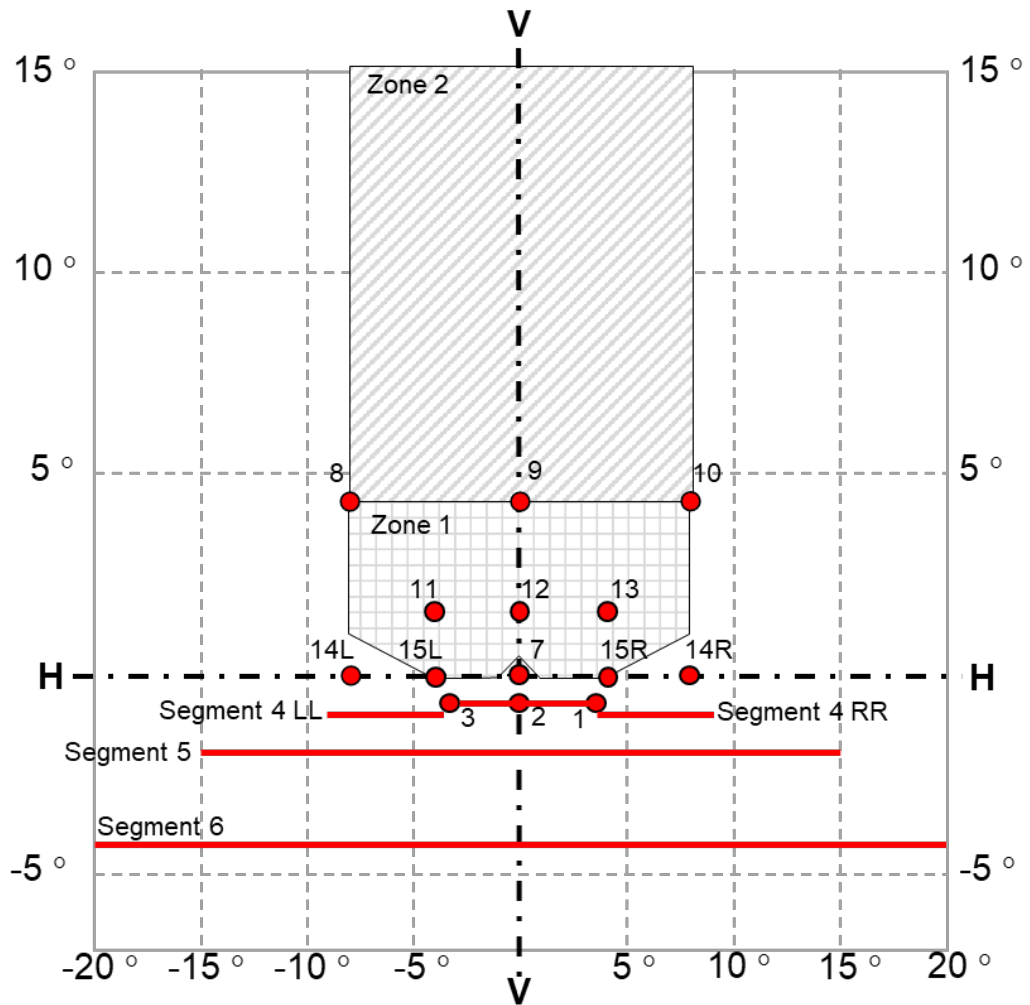

Figure A4-X  
**Light distribution of the Class F3 front fog lamp (left side lamp)**

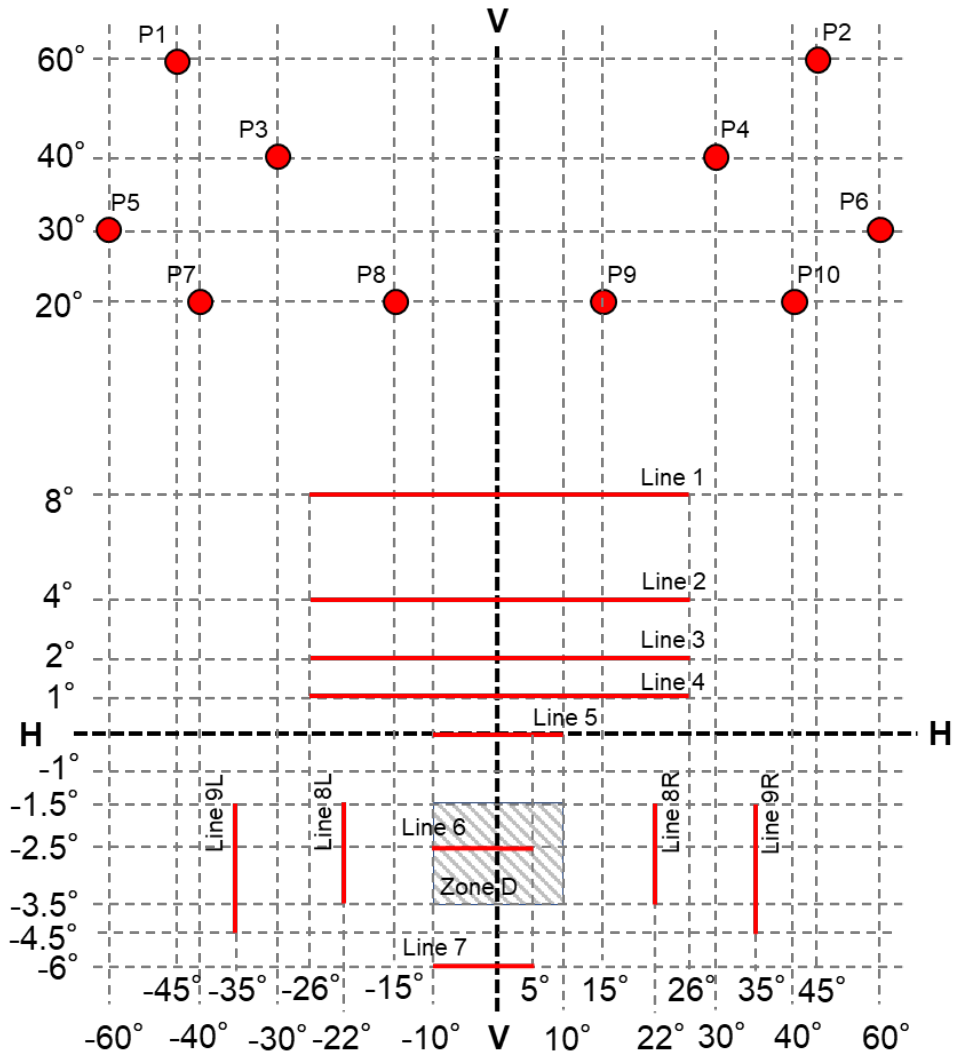

Figure A4-XI  
**Light distribution of the cornering lamp (Left side lamp)**

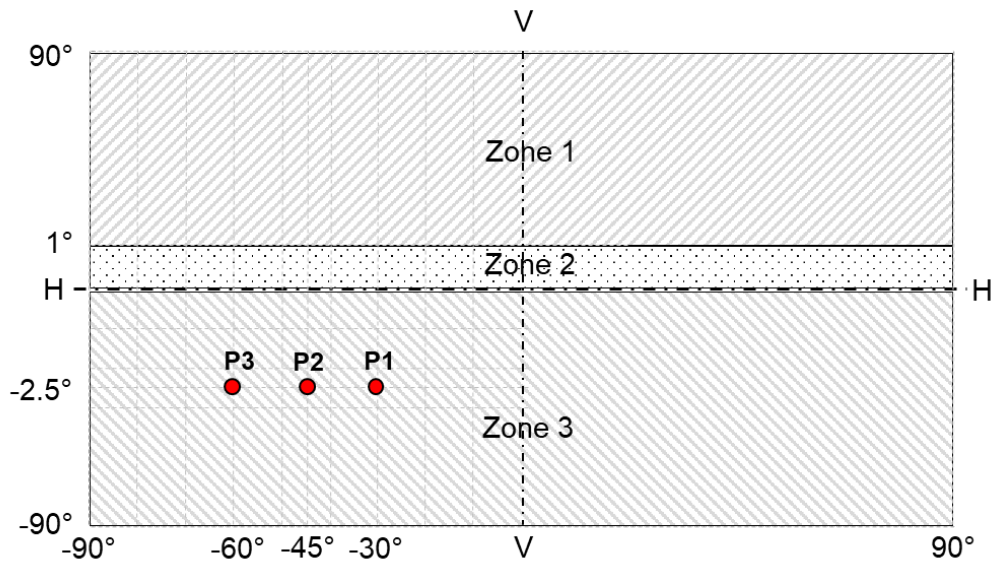

Figure A4-XII  
**Horizontal geometric visibility for cornering lamps**

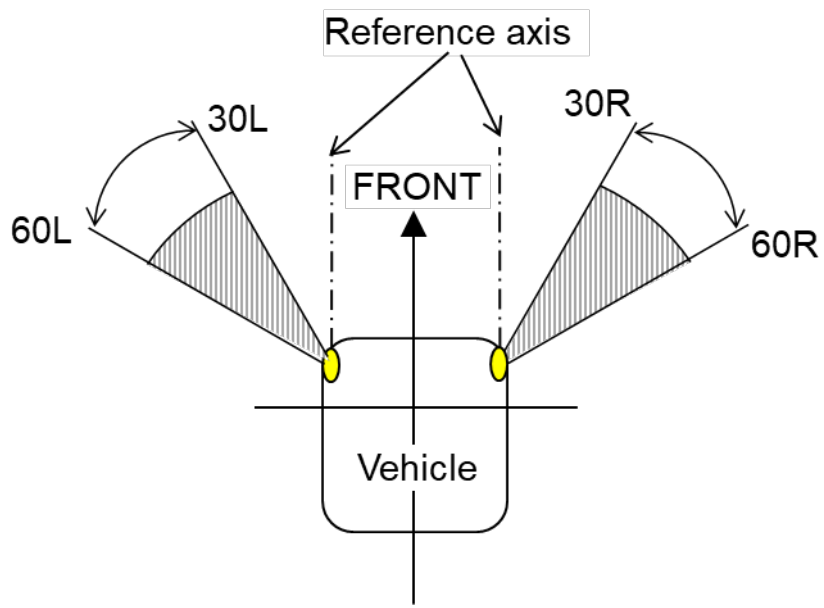
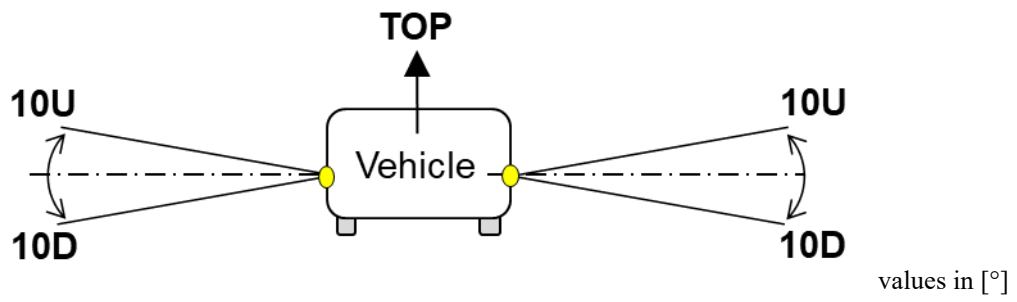

Figure A4-XIII  
Vertical geometric visibility for cornering lamps



## Annex 5

### Visual aiming method of Road Illumination Devices. Definition of "cut-off" line for passing-beam headlamps and front fog lamps.

1. General
  - 1.1. The aiming of a road illumination device enables the luminous intensity distribution of the lamp to be adjusted correctly for the photometric measurements and for the aiming on the vehicle.
  - 1.2. The aiming shall be carried out using a flat vertical screen set up at a distance of 10 m or 25 m (as indicated in item 9 of Annex 1) forward of the device and at right angles to the H-V axis as shown in Annex 4. The screen shall be sufficiently wide to allow examination and adjustment of the device over at least 5° on either side of the V-V line.
2. "Cut-off" definition
  - 2.1. The luminous intensity distribution of a principal passing-beam headlamp or of at least one lighting unit for a class C passing-beam of an AFS or of a front fog lamp in its neutral state shall incorporate a "cut-off".
    - 2.1.1. The asymmetric "cut-off" line shall provide:
      - (a) For right hand traffic beams (see Figure A5-I) :
        - (i) A straight "horizontal part" towards the left;
        - (ii) A raised "elbow - shoulder" part towards the right.
      - (b) For left hand traffic beams:
        - (i) A straight "horizontal part" towards the right;
        - (ii) A raised "elbow - shoulder" part towards the left.

In each case the "elbow-shoulder" part shall have a sharp edge.

Figure A5-I

**Visual aiming of the asymmetric cut-off line (right hand traffic passing-beam)**

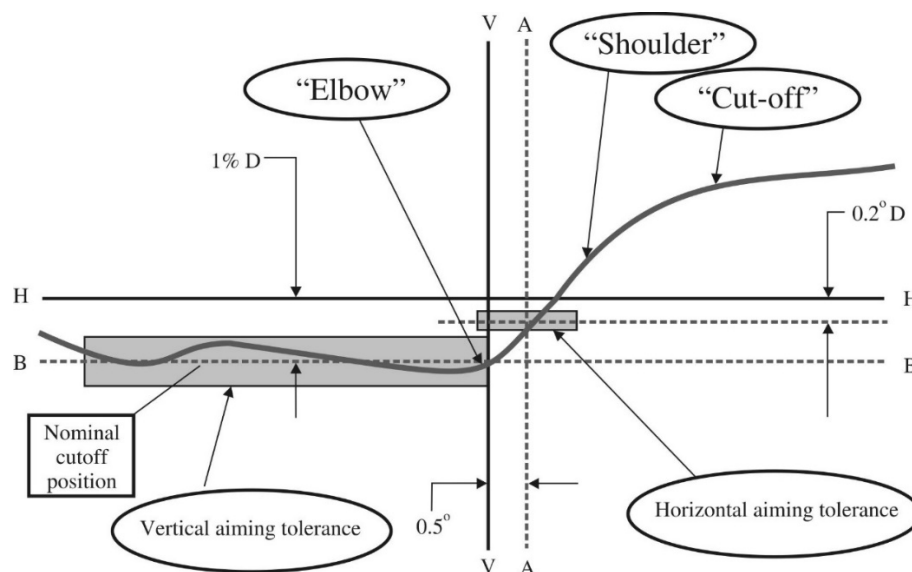

Note: The scales are different for vertical and horizontal lines.

- 2.1.2. The symmetric "cut-off" line shall provide a straight "horizontal part" towards the left and the right (see Figure A5-II)

Figure A5-II

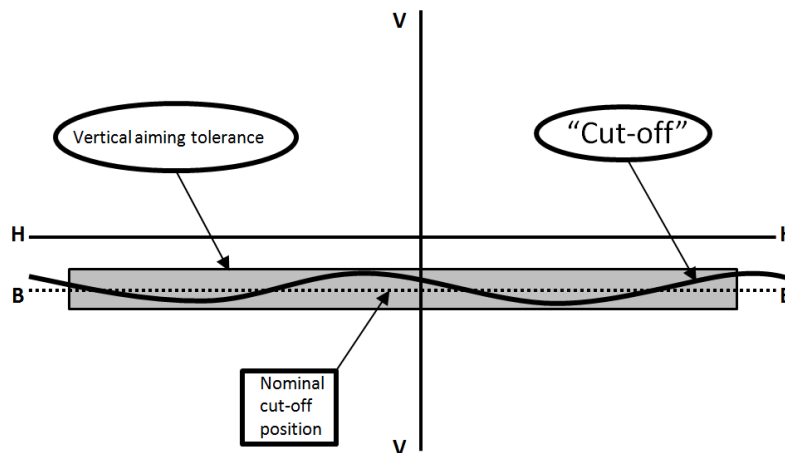
**Visual aiming of the symmetric cut-off line**

Note: The scales are different for vertical and horizontal lines.

3. Visual aiming procedure
- 3.1. Aiming of device designed to provide a driving-beam of the Class A, B, RA, BS, CS or DS (symbols "R", "HR", "RA", "XR", "R-BS", "WR-CS" or "WR-DS")
- 3.1.1. In the case of a road illumination device designed to provide a driving-beam not being adjustable independently from the passing-beam, measurements of the luminous intensity of the driving-beam shall be taken with the same alignment as for the measurements of the passing-beam. The passing-beam shall be aimed according to paragraph 3.2.
- 3.1.2. In the case of a road illumination device providing a driving-beam being adjustable independently from the passing-beam, it shall be so adjusted that the area of maximum luminous intensity is centered on the point of intersection of lines H-H and V-V
- 3.2. Aiming of device designed to provide a passing-beam (asymmetric "cut-off" line) of the Classes C and V
- 3.2.1. In the case of a road illumination device providing a principal passing-beam headlamp or at least one lighting unit for a class C passing-beam of an AFS, the device shall be visually aimed by means of the "cut-off" (see Figure A5-I) as follows.
- 3.2.1.1. For vertical adjustment: the horizontal part of the "cut-off" is moved upward from below line B and adjusted to its nominal position one per cent ( $0.57^\circ$ ) below the H-H line;
- 3.2.1.2. For horizontal adjustment: the "elbow – shoulder" part of the "cut-off" shall be moved from:
- right to left for right hand traffic; or
  - left to right for left hand traffic
- and shall be horizontally positioned after its movement so that:
- (a) Above the line  $0.2^\circ D$  its "shoulder" shall not exceed the line A:
- to the left for right hand traffic; or
  - to the right for left hand traffic

- (b) The line  $0.2^\circ$ D or below its "shoulder" should cross the line A; and
  - (c) The kink of the "elbow" is basically located within  $\pm 0.5^\circ$  to the left or right of the V-V line;
- 3.2.2. In the case of a headlamp designed to provide bend lighting its alignment may be changed, provided that the axis of the beam is not displaced vertically by more than  $0.2^\circ$ .
- 3.3. Aiming of device designed to provide a passing-beam (symmetric "cut-off" line) of the Classes AS, BS, CS and DS (see Figure A5-II)
- 3.3.1. In the case of a road illumination device providing a principal passing-beam headlamp, the device shall be visually aimed by means of the "cut-off" (see Figure A5-II) as follows.
- 3.3.1.1. For vertical adjustment: according to paragraph 3.2.1.1..
- 3.3.1.2. For horizontal adjustment: the cut-off line shall be so positioned that the projected beam pattern appears approximately symmetrical to the V-V line.
- 3.4. Aiming of device designed to provide a front fog lamp (symmetric "cut-off" line) of Class F3 (see Figure A5-II).
- 3.4.1. In the case of a road illumination device providing a front fog lamp, the device shall be visually aimed by means of the "cut-off" (see Figure A5-II) as follows.
- 3.4.1.1. For vertical adjustment: the "cut-off" is moved upward from below line B and adjusted to its nominal position 1 degrees below the H-H line;
- 3.4.1.2. For horizontal adjustment: according to paragraph 3.3.1.2.
- When the front fog lamp is designed for use in pairs or has otherwise an asymmetric beam pattern, it shall be horizontally aligned according to the specification of the applicant, or otherwise in such a way that the cut-off line appears symmetrical to the V-V line.
- 3.5. Aiming of device designed to provide a cornering lamp
- 3.5.1. In the case of a road illumination device providing a cornering lamp the device shall be installed on the goniometer in the axis of reference according to requirements set out in paragraph 3.1.2.1. (a) and (b) of this Regulation.
4. Aiming tolerances applied to road illumination devices (alignment change)
- 4.1. Where a road illumination device aimed as described in paragraph 3. does not meet the device specific requirements set out in paragraphs 5. or 6.2. of this Regulation, its alignment may be changed, provided that the axis of the beam is not displaced:

Horizontally not more than:

- (a)  $0.75^\circ$  to the left or to the right for device designed to provide a passing-beam or a driving-beam not being adjustable independently from the passing-beam; or
- (b)  $1^\circ$  to the left or to the right for device designed to provide a driving-beam being adjustable independently from the passing-beam; or
- (c)  $2^\circ$  to the left or to the right for device designed to provide a front fog lamp or a cornering lamp

Vertically not more than:

- (a)  $0.25^\circ$  up or down for device designed to provide a passing-beam or a driving-beam not being adjustable independently from the passing-beam; or
- (b)  $0.5^\circ$  up or down for device designed to provide a driving-beam being adjustable independently from the passing-beam; or

(c) 0.5° up or down for device designed to provide a front fog lamp or a cornering lamp

- 4.1.1. Where a driving-beam not being adjustable independently from the passing-beam aimed as described in paragraph 3 does not meet the specific requirements set out in paragraph 5.1. or 6.2. of this Regulation the alignment of the device may be changed with respect to the passing-beam first aiming.
- 4.1.2. Where an AFS aimed as described in paragraph 3. does not meet the specific requirements set out in paragraph 5.3. or 6.2. of this Regulation the alignment of the system may be changed in each class independently with respect to the first aiming.
- 4.2. If, however, vertical adjustment of the device providing a passing-beam or a front fog lamp cannot be performed repeatedly to the required position within the tolerances described in paragraph 4.1., the instrumental method of Annex 6 shall be applied to test compliance with the required minimum quality of the "cut-off" and to perform the vertical and horizontal adjustment of the beam.



## Annex 6

### **Instrumental aiming method for a device providing a passing-beam or a front fog lamp and requirements for "cut-off" line**

1. General
  - 1.1. The aiming of a road illumination device enables the luminous intensity distribution of the lamp to be adjusted correctly for the photometric measurements and for the aiming on the vehicle.
  - 1.2. The instrumental aiming method shall be applied to test compliance with the required minimum quality of the "cut-off" and to perform the vertical and horizontal adjustment of the beam only if the vertical adjustment of the device providing a passing-beam or a front fog lamp cannot be performed repeatedly to the required position and tolerances described in Annex 5.
  - 1.3. The "cut-off" definition is given in Annex 5, paragraph 2.
2. Instrumental verification of the "cut-off" line
  - 2.1. In the case where paragraph 1.2. applies, the quality of the "cut-off" line shall be tested according to the requirements set out in paragraph 2.2. and the instrumental vertical and horizontal adjustment of the beam shall be performed according to the requirements set out in paragraph 2.3.  
  
Before carrying out the measurement of the quality of "cut-off", and the instrumental aiming procedure, a visual pre-aim in accordance with device specific paragraph(s) of Annex 5 is required.
  - 2.2. Measurement of the quality of the "cut-off"
    - To determine the minimum sharpness, measurements shall be performed by vertically scanning through the horizontal part of the "cut-off" in angular steps of  $0.05^\circ$  at either a measurement distance of:
      - (a) 10 m with a detector having a diameter of approximately 10 mm; or
      - (b) 25 m with a detector having a diameter of approximately 30 mm.

The measuring distance at which the test was carried out shall be recorded in item 9. of the communication form (see Annex 1 to this Regulation).

To determine the maximum sharpness, measurements shall be performed by vertically scanning through the horizontal part of the "cut-off" in angular steps of  $0.05^\circ$  exclusively at a measurement distance of 25 m and with a detector having a diameter of approximately 30 mm.

The "cut-off" quality shall be considered acceptable if the requirements of paragraphs 2.2.1. to 2.2.3. comply with at least one set of measurements.
  - 2.2.1. Not more than one "cut-off" shall be visible<sup>1</sup>
  - 2.2.2. Sharpness of "cut-off"
    - The sharpness factor G is determined by scanning vertically through the horizontal part of the "cut-off" at:
      - (a)  $2.5^\circ$  from the V-V line for passing-beam designed to provide asymmetric "cut-off" line; or

<sup>1</sup> This paragraph should be amended when an objective test method is available.

- (b) 2.5° left and right from the V-V line for passing-beam and front fog lamp designed to provide symmetric “cut-off” line

where:

$G = (\log E_{\beta} - \log E_{(\beta + 0.1^{\circ})})$  where  $\beta$  = the vertical position in degrees and  $E$  = the illumination on the aiming screen.

The value of  $G$  shall not be less than:

- (a) 0.13 (minimum sharpness) for passing-beam designed to provide asymmetric “cut-off” line; or  
 (b) 0.08 (minimum sharpness) for passing-beam and front fog lamp designed to provide symmetric “cut-off” line

and not greater than 0.40 (maximum sharpness) for passing-beam designed to provide asymmetric “cut-off” line.

### 2.2.3. Linearity

#### 2.2.3.1. Inflection points of the "cut-off" gradient

- (a) For passing-beam designed to provide asymmetric “cut-off” line the part of the horizontal “cut-off” that serves for vertical adjustment shall be horizontal between 1.5° and 3.5° from the V-V line (see Figure A6-I).  
 (b) For passing-beam and front fog lamp designed to provide symmetric “cut-off” line the part of the horizontal “cut-off” shall be horizontal between 3° left and right from the V-V line (see Figure A6-II).

The inflection points of the “cut-off” gradient at the vertical lines at 1.5°, 2.5° and 3.5° shall be determined by the equation:

$$(d^2 (\log E) / d\beta^2 = 0).$$

The maximum vertical distance between the inflection points determined shall not exceed:

- (a) 0.2° for passing-beam designed to provide asymmetric “cut-off” line;  
 or  
 (b) 0.5° for passing-beam and front fog lamp designed to provide symmetric “cut-off” line

Figure A6-I

#### Measurement of the asymmetric “cut-off” quality

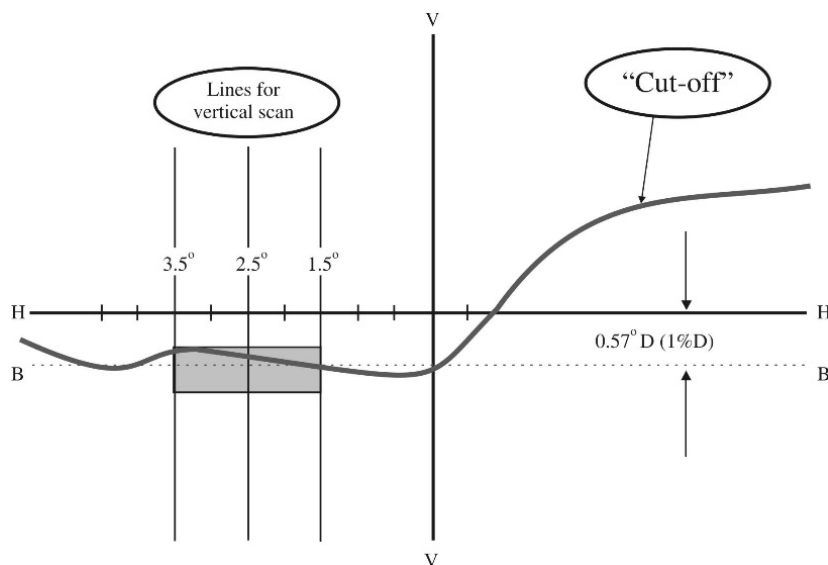

Note: The scales are different for vertical and horizontal lines.

Figure A6-II  
**Measurement of the symmetric "cut-off" quality and instrumental vertical adjustment**

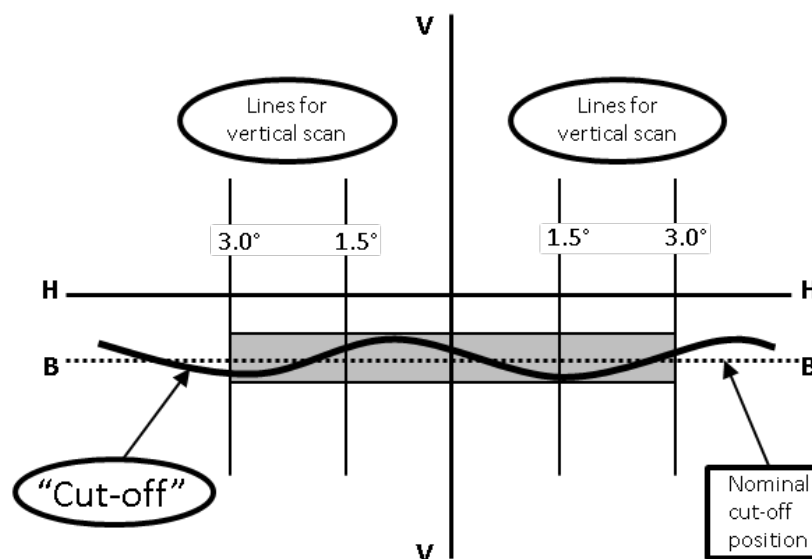

*Note:* The scales are different for vertical and horizontal lines.

2.3. Vertical and horizontal adjustment

If the "cut-off" complies with the quality requirements of paragraph 2.2. the beam adjustment may be performed instrumentally.

2.3.1. Vertical adjustment

Moving upward from below the line B, a vertical scan is carried out through the horizontal part of the "cut-off":

- (a) at 2.5° from V-V line for passing-beam headlamp designed to provide asymmetric "cut-off" line (see Figure A6-III) on the left side of V-V line for right hand traffic and on the right side of V-V line for left hand traffic
- (b) on the V-V line for passing-beam and front fog lamp designed to provide symmetric "cut-off" line (see Figure A6-II)

The inflection point (where  $d^2(\log E) / d\beta^2 = 0$ ) is determined and positioned on the line B situated:

- (a) 0.57° (1 per cent) below H-H. line for passing-beam headlamp
- (b) 1° below H-H line for front fog lamp

2.3.2. Horizontal adjustment

2.3.2.1. Horizontal adjustment of passing-beam headlamp designed to provide asymmetric "cut-off" line

The applicant shall specify one of the following horizontal aim methods:

- (a) The "0.2°D line" method (see Figure A6-III).

A single horizontal line at 0.2°D shall be scanned from 5° left to 5° right after the lamp has been aimed vertically. The maximum gradient "G" determined using the formula  $G = (\log E_{\beta} - \log E_{(\beta + 0.1^\circ)})$  where  $\beta$  is the horizontal position in degrees, shall not be less than 0.08.

The inflection point found on the 0.2°D line shall be positioned on the line A.

Figure A6-III

**Instrumental vertical and horizontal adjustment for asymmetric “cut-off” line- horizontal line scan method**

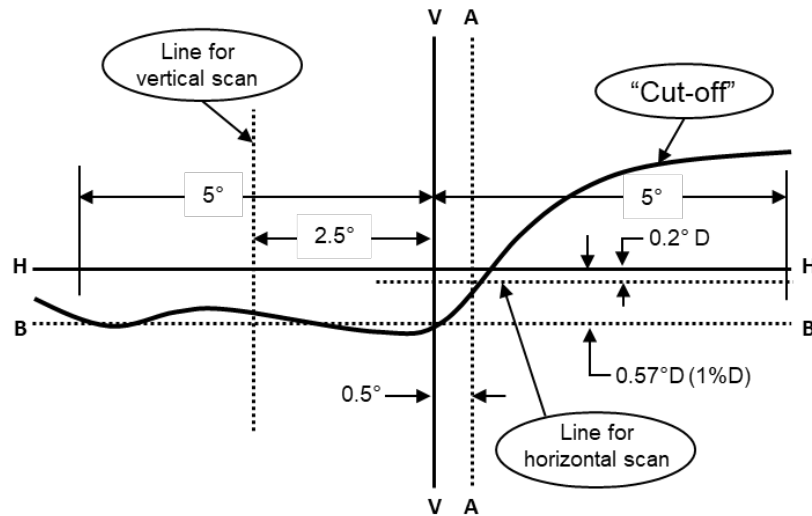

Note: The scales are different for vertical and horizontal lines.

(b) The "3 line" method (see Figure A5-IV)

Three vertical lines shall be scanned from 2°D to 2°U at 1°R, 2°R, and 3°R after the lamp has been aimed vertically. The respective maximum gradients "G" determined using the formula:

$$G = (\log E_{\beta} - \log E_{(\beta + 0.1^\circ)})$$

where  $\beta$  is the vertical position in degrees, shall not be less than 0.08. The inflection points found on the three lines shall be used to derive a straight line. The intersection of this line and the line B found while performing vertical aim shall be placed on the V line.

Figure A6-IV

**Instrumental vertical and horizontal adjustment for asymmetric “cut-off” line - Three-line scan method**

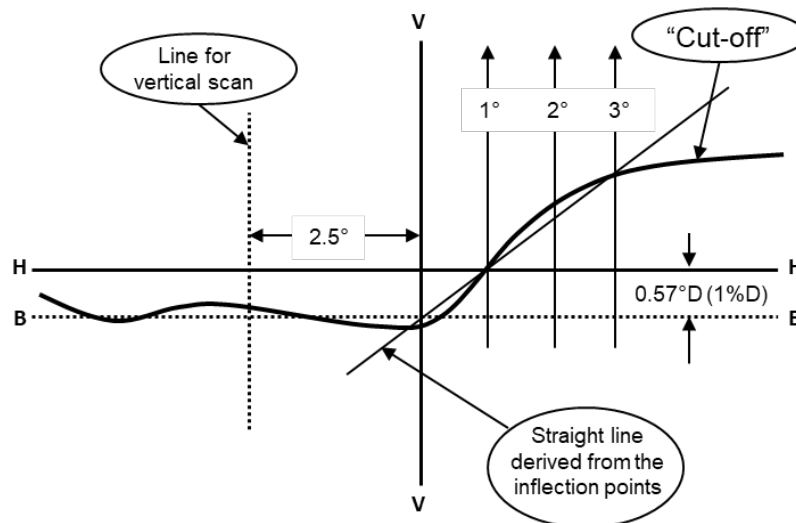

Note: The scales are different for vertical and horizontal lines.

2.3.2.2. Horizontal adjustment of passing-beam headlamp or front fog lamp designed to provide symmetric “cut-off” line:

The cut-off line shall be so positioned that the projected beam pattern appears approximately symmetrical to the V-V line.

- 2.3.2.2.1. In case of front fog lamps designed for use in pairs or has otherwise an asymmetric beam pattern, the “cut-off” line shall be horizontally aligned according to the specification of the applicant, or otherwise in such a way that the cut-off line appears symmetrical to the V-V line.

## Annex 7

### Tests for stability of photometric performance of Road Illumination Devices in operation (except cornering lamps)

1. Tests on complete Road Illumination Devices (RID)
 

Once the photometric values have been measured according to this Regulation:

  - (a) In the case of a headlamp with an asymmetrical passing-beam or AFS:
 

$I_{\max}$  for driving-beam and in points 40L, 50R, B50L for passing-beam (or 40R, 50L, B50R for headlamps designed for left-hand traffic);
  - (b) In the case of a headlamp with a symmetrical passing-beam:
 

$I_{\max}$  for driving-beam and in points 0.50°U/1.5°L and 0.50°U/1.5°R, 50R, 50L for Class BS passing-beam and in points 0.86°D-3.5°R, 0.86°D-3.5°L, for Classes CS and DS passing-beams;
  - (c) In the case of front fog lamps:
 

at the point of maximum illumination in zone D ( $I_{\max}$ ) and in the point HV;

A complete sample shall be tested for stability of photometric performance in operation.
- 1.1. In the case of headlamps or front fog lamps:
 

"Complete sample" shall be understood to mean the complete lamp itself including ballast(s) and those surrounding body parts, light sources or light source module(s) which could influence its thermal dissipation.
- 1.2. In the case of an AFS:
  - (a) "Complete sample" shall be understood to mean the complete right and left side of a system itself including electronic light source control-gear(s) and/or supply and operating device(s) and those surrounding body parts and lamps which could influence its thermal dissipation. Each installation unit of the system and lamp(s) and/or light source module, if any, of the complete system may be tested separately.
  - (b) "Test sample" in the following text means correspondingly either the "complete sample" or the installation unit under test.
- 1.3. The tests shall be carried out:
  - (a) In a dry and still atmosphere at an ambient temperature of  $23\text{ °C} \pm 5\text{ °C}$ , the test sample being mounted on a base representing the correct installation on the vehicle;
  - (b) In case of replaceable light sources: using mass production filament light sources, which have been aged for at least one hour, or mass production gas-discharge light sources, which have been aged for at least 15 hours or mass production LED light source and LED modules which have been aged for at least 48 hours and cooled down to ambient temperature before starting the tests as specified in this Regulation. The LED modules supplied by the applicant shall be used.
  - (c) In the case of an AFS providing an adaptation of the driving-beam, the driving-beam shall be in the maximum condition if activated.
- 1.4. The measuring equipment shall be equivalent to that used during type approval tests. The AFS or part(s) thereof shall, prior to the subsequent tests, be set to the neutral state.

The test sample shall be operated without being dismantled from or readjusted in relation to its test fixture. The light source used shall be a light source of the category specified for that headlamp.

2. Test for stability of photometric performance

2.1. Clean device

The device shall be operated for 12 hours as described in paragraph 2.1.1. and checked as prescribed in paragraph 2.1.2..

2.1.1. Test procedure <sup>1</sup>

2.1.1.1. The device shall be operated for a period according to the specified time, so that:

(a) In the case where a device is designed to provide only one lighting function (driving-beam or passing-beam or front fog lamp) and not more than one class in case of passing-beam, the corresponding light emitting element (s) is/are lit for the time<sup>2</sup> specified in paragraph 2.1.;

(b) In the case where a device is designed to provide two or more lighting functions, the device shall be subjected to the following cycle until the time specified is reached as follows:

- 15 minutes, main mode lit
- 5 minutes, all other functions which, according to the manufacturer's specifications, in the same body are intended to be used simultaneously<sup>2</sup> and which, in combination draw the highest total wattage lit

(c) In the case of a passing-beam designed to provide bend lighting with the addition of light source(s) or light source module(s), it/they shall be switched ON for one minute, and switched OFF for nine minutes during the activation of the passing-beam only.

If the headlamp has several additional light sources used to produce bend lighting, the test shall be carried out with the combination of light source(s) that represents the most severe operating condition.

(d) In the case of a headlamp equipped with cornering lamp with the addition of light source(s) or light source module(s), it /they shall be switched ON for one minute, and switched OFF for nine minutes during the activation of the passing-beam only.

(e) In the case that the driving-beam uses several light sources and if the applicant declares that a part of the driving-beam (one of these additional light sources) will be used exclusively for short time signals (flash to pass), the test shall be carried out without this part of the driving-beam.

2.1.1.2. Test voltage

The voltage shall be applied to the terminals of the test sample as follows:

(a) In case of replaceable filament light source(s) operated directly under vehicle voltage system conditions:

The test shall be performed at 6.3 V, 13.2 V or 28.0 V as applicable except if the applicant specifies that the test sample may be used at a

<sup>1</sup> For the test schedule see Annex 7, Appendix 1.

<sup>2</sup> When the tested headlamp includes signaling lamps, the latter shall be lit for the duration of the test, except for a daytime running lamp. In the case of a direction indicator lamp, it shall be lit in flashing mode with an on/ off time of approximately one to one.

different voltage. In this case, the test shall be carried out with the filament light source operated at the highest voltage that can be used.

- (b) In case of replaceable gas discharge light source(s):  
The test voltage for the electronic light source control-gear or the light source, in case the ballast is integrated with the light source, is  $13.2 \pm 0.1$  volts for 12 V vehicle voltage system, or otherwise specified in the application for approval.
- (c) In the case of non-replaceable light source operated directly under vehicle voltage system conditions: All measurements on lighting units equipped with non-replaceable light sources (filament light sources and/ or others) shall be made at 6.3 V, 13.2 V or 28.0 V or at other voltages according to the vehicle voltage system as specified by the applicant respectively.
- (d) In the case of light sources, replaceable or non-replaceable, being operated independently from vehicle supply voltage and fully controlled by the system, or, in the case of light sources supplied by a supply and operating device, the test voltages as specified above shall be applied to the input terminals of that device. The test laboratory may require from the manufacturer the supply and operating device or a special power supply needed to supply the light source(s).
- (e) LED light source(s) and light source module(s) shall be measured at 6.3 V, 13.2 V or 28.0 V respectively, if not otherwise specified within the pertinent Regulation. LED light source(s) and light source module(s) operated by an electronic light source control gear, shall be measured as specified by the applicant.
- (f) Where signalling lamps are grouped, combined or reciprocally incorporated into the test sample and operating at voltages other than the nominal rated voltages of 6 V, 12 V or 24 V respectively, the voltage shall be adjusted as declared by the manufacturer for the correct photometric functioning of that lamp.
- (g) For a gas-discharge light source, the test voltage for the ballast or for the light source in case the ballast is integrated with the light source is  $13.2 \pm 0.1$  volts for 12 V network system, or otherwise specified in the application for approval.

## 2.1.2. Test results

### 2.1.2.1. Visual inspection

Once the headlamp has been stabilized to the ambient temperature, the headlamp lens and the external lens, if any, shall be cleaned with a clean, damp cotton cloth. It shall then be inspected visually; no distortion, deformation, cracking or change in colour of either the headlamp lens or the external lens, if any, shall be noticeable.

### 2.1.2.2. Photometric test

To comply with the requirements, the photometric values shall be verified in the following points:

#### 2.1.2.2.1. In the case of a headlamp with an asymmetrical passing-beam pattern:

- (a) Passing-beam:
- 50R - B50L - 40L for headlamps designed for right-hand traffic;
  - 50L - B50R - 40R for headlamps designed for left-hand traffic.
- (b) Driving-beam:  $I_{\max}$



Another aiming may be carried out to allow for any deformation of the headlamp base due to heat (the change of the position of the cut-off line is covered in paragraph 3.).

Except for point B50L, a 10 per cent discrepancy between the photometric characteristics and the values measured prior to the test is permissible including the tolerances of the photometric procedure. The value measured at point B50L shall not exceed the photometric value measured prior to the test by more than  $1.70 \cdot 10^2$  cd.

2.1.2.2.2. In the case of a headlamp with a symmetrical passing-beam pattern:

(a) Class BS headlamp:

- Passing-beam: 50R - 50L - 0.50°U/1.5°L and 0.50°U/1.5°R.
- Driving-beam:  $I_{\max}$

(b) For Classes CS and DS headlamp:

- Passing-beam: 0.86°D/3.5°R - 0.86°D/3.5°L - 0.50°U/1.5°L and 0.50°U/1.5°R.
- Driving-beam:  $I_{\max}$

Another aiming may be carried out to allow for any deformation of the headlamp base due to heat (the change of the position of the cut-off line is covered in paragraph 3.).

Except for points 0.50°U/1.5°L and 0.50°U/1.5°R, a 10 per cent discrepancy between the photometric characteristics and the values measured prior to the test is permissible including the tolerances of the photometric procedure. The value measured at points 0.50°U/1.5°L and 0.50°U/1.5°R shall not exceed the photometric value measured prior to the test by more than  $2.55 \cdot 10^2$  cd.

2.1.2.2.3. In the case of front fog lamps on point HV and  $I_{\max}$  in zone D.

Another aiming may be carried out to allow for any deformation of the front fog lamp base due to heat (the change of the position of the cut-off line is covered in paragraph 3.).

A 10 per cent discrepancy between the photometric characteristics and the values measured prior to the test is permissible including the tolerances of the photometric procedure.

2.2. Dirty headlamp

After being tested as specified in paragraph 2.1., the headlamp shall be operated for one hour as described in paragraph 2.1.1. for each function after being prepared as prescribed in paragraph 2.2.1., and checked as prescribed in paragraph 2.1.2., after each test a sufficient cooling down period must be assured.

2.2.1. Preparation of the headlamp

2.2.1.1. Test mixture:

See Appendix 2 to this Annex

2.2.1.2. Application of the test mixture to the headlamp

The test mixture shall be uniformly applied to the entire light-emitting surface of the headlamp and then left to dry. This procedure shall be repeated until the illumination value has dropped to 15-20 per cent of the values measured for each following point under the conditions described below:

(a) In the case of a headlamp with an asymmetrical beam pattern or AFS:

- (i)  $I_{\max}$  in passing-beam/driving-beam and in driving-beam only;

- (ii) 50R and 40L for a headlamp producing only a passing-beam, designed for right-hand traffic;
- (iii) 50L and 40R for a headlamp producing only a passing-beam, designed for left-hand traffic.
- (b) In the case of a headlamp with a symmetrical beam pattern:
  - (i) For Class BS headlamp:
    - Passing-beam/driving-beam and driving-beam only:  $I_{\max}$
    - Passing-beam only: 50L and 50R
  - (ii) For Classes CS and DS headlamp:
    - Passing-beam/driving-beam and driving-beam only:  $I_{\max}$
    - Passing-beam only:  $0.50^{\circ}\text{U}/1.5^{\circ}\text{L}$ ,  $0.50^{\circ}\text{U}/1.5^{\circ}\text{R}$  and  $0.86^{\circ}\text{D}/\text{V}$
- (c) In the case of a front fog lamp:
  - $I_{\max}$  in zone D.

3. Test for change in vertical position of the cut-off line under the influence of heat.

This test consists of verifying that the vertical drift of the cut-off line under the influence of heat does not exceed a specified value for an operating headlamp producing a passing-beam, for front fog lamps, or in the case of an AFS for a system or part(s) of emitting a class C (basic) passing-beam, or each specified passing-beam mode.

The device tested in accordance with paragraph 2., shall be subjected to the test described in paragraph 3.1., without being removed from or readjusted in relation to its test fixture.

If the AFS consists of more than one lighting unit or more than one assembly of lighting units which provide a cut-off, each of these is understood to be a test sample for the purpose of this test and must be tested separately.

If the AFS has a moving optical part, only the position closest to the average vertical angular stroke and/or the initial position according to the neutral state is chosen for this test.

The test is confined to signal input conditions corresponding to a straight road, only.

3.1. Test Procedure

3.1.1. For the purpose of this test, the voltage shall be adjusted as specified in paragraph 2.1.1.2.;

The test shall be carried out in a dry and still atmosphere at an ambient temperature of  $23^{\circ}\text{C} \pm 5^{\circ}\text{C}$ .

The device shall be operated without being dismantled from or readjusted in relation to its test fixture. (For the purpose of this test, the voltage shall be adjusted as specified in paragraph 2.1.1.2.):

- (a) Using a mass production filament light source as submitted with the device, which has been aged for at least 1 hour;
- (b) Using mass production LED light source(s) and/or the LED module(s) as submitted with the device, which has been aged for at least 48 hours;
- (c) Using a mass production gas-discharge light source which has been aged for at least 15 hours.

3.1.2. In the case of a device with an asymmetrical beam pattern:

the position of the "cut-off" line in its horizontal part (between V-V and the vertical lines passing through point B50L for right-hand traffic or B50R for left-hand traffic) shall be verified 3 minutes (r3) and 60 minutes (r60) respectively after operation.

- 3.1.3. In the case of a headlamp with a symmetrical beam pattern: the position of the "cut-off" line in its horizontal part (between V-V and the vertical lines passing through point 50L and 50R for Class BS headlamp, 3.5°L and 3.5°R for Class CS and DS headlamp) shall be verified 3 minutes (r3) and 60 minutes (r60) respectively after operation.
- 3.1.4. In the case of a front fog lamps: the position of the "cut-off" line between a point situated 3.0° left and a point situated 3.0° right of the cut-off line V-V shall be verified 3 minutes (r3) and 60 minutes (r60) respectively after operation.

The measurement of the variation in the cut-off line position as described above shall be carried out by any method giving acceptable accuracy and reproducible results.

### 3.2. Test results

- 3.2.1. The result, expressed in milliradians (mrad), shall be considered as acceptable when:

- (a) In case of headlamps or AFS, the absolute value  $\Delta r_1 = |r_3 - r_{60}|$  recorded on the device is not more than 1.0 mrad ( $\Delta r_1 \leq 1.0$  mrad) upward and not more than 2.0 mrad ( $\Delta r_1 \leq 2.0$  mrad) downwards.
- (b) In case of front fog lamps, the absolute value  $\Delta r_1 = |r_3 - r_{60}|$  recorded on this device is not more than 2.0 mrad ( $\Delta r_1 \leq 2.0$  mrad).

- 3.2.2. However, if the result does not comply with the requirements in paragraph 3.2.1. and does not exceed the values in Table A7-1, a further sample mounted on a test fixture representative of the correct installation on the vehicle shall be tested as described in paragraph 3.1. after being subjected three consecutive times to the cycle as described below, in order to stabilise the position of the mechanical parts of the device:

- (a) Operation of the device for one hour (the voltage shall be adjusted as specified in paragraph 2.1.1.2.);
- (b) One hour period with the lamp switched OFF.

After these three cycles, the device shall be considered as acceptable if the absolute values  $\Delta r$  measured according to paragraph 3.2. on this further sample meet the requirements in paragraph 3.2.1.

Table A7-1  
**Movement values**

<i>Movement</i>	<i>Device</i>	<i>Value</i>
Upward	Headlamp or AFS	1.5 mrad
	Front fog lamp	3.0 mrad
Downward	All	3.0 mrad

## Annex 7 - Appendix 1

### Overview of operational periods concerning test for stability of photometric performance

Abbreviations:	P: passing-beam lamp
	D: driving-beam lamp (D <sub>1</sub> + D <sub>2</sub> means two driving-beams)
	F: front fog lamp
—————	Means continuously lit
- - - - -	means a cycle of 15 minutes off and 5 minutes lit
— — — — —	means a cycle of 15 minutes lit and 5 minutes off
. . . . .	means a cycle of 9 minutes off and 1 minute lit

All the following grouped headlamps and front fog lamps are given as examples and are not exhaustive.

**Figure A7-I**

Example of a headlamp equipped with one lighting function and bend lighting and/or cornering lamp.

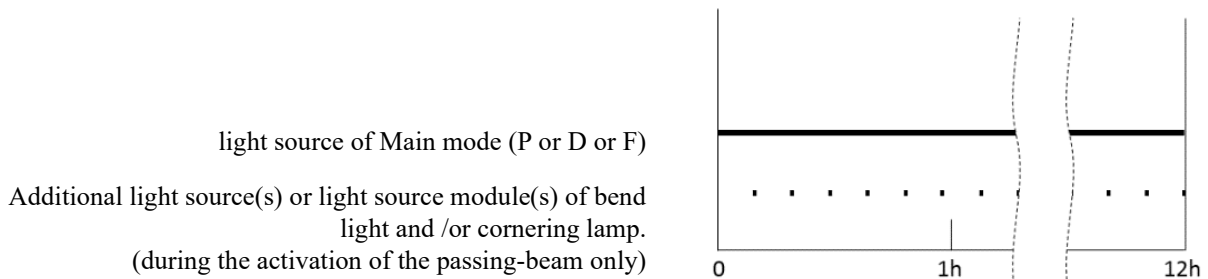

**Figure A7-II**

Example of a headlamp equipped with several lighting functions, and bend lighting and/or cornering lamp.

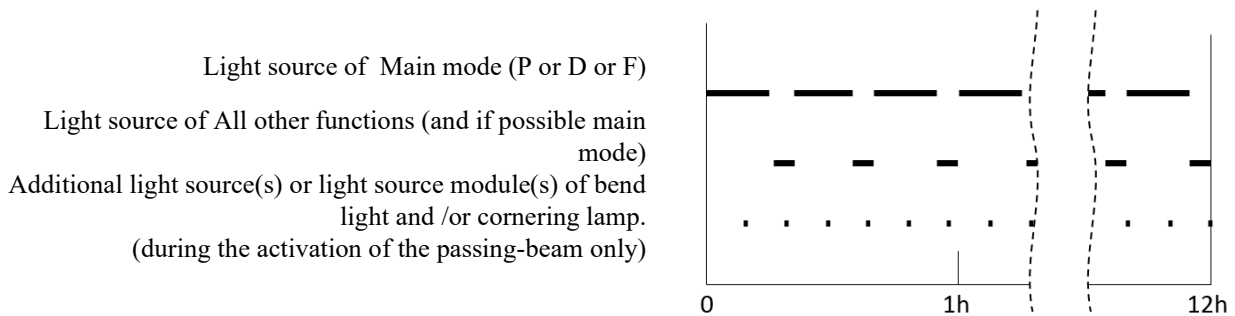

## Annex 7 - Appendix 2

### Test mixture for dirty headlamp test

1. For devices with the outer lens made of glass:

The mixture of water and a polluting agent to be applied to the device shall be composed of:

  - (a) 9 parts by weight of silica sand with a particle size of 0-100 µm;
  - (b) 1 part by weight of vegetal carbon dust produced from beech wood with a particle size of 0-100 µm;
  - (c) 0.2 parts by weight of NaCMC;<sup>1</sup> and
  - (d) 5 parts by weight of sodium chloride (pure at 99 per cent);
  - (e) an appropriate quantity of distilled water, with a conductivity of  $\leq 1$  mS/m.

The mixture shall not be more than 14 days old.
2. For devices with outer lens made of plastic material:

The mixture of water and polluting agent to be applied to the device shall be composed of:

  - (a) 9 parts by weight of silica sand with a particle size of 0-100 µm;
  - (b) 1 part by weight of vegetal carbon dust produced from beech wood with a particle size of 0-100 µm;
  - (c) 0.2 parts by weight of NaCMC;<sup>1</sup> and
  - (d) 5 parts by weight of sodium chloride (pure at 99 per cent);
  - (e) 13 parts by weight of distilled water with a conductivity of  $\leq 1$  mS/m; and
  - (f)  $2 \pm 1$  drops by weight of surfactant.<sup>2</sup>

The mixture shall not be more than 14 days old.

---

<sup>1</sup> NaCMC represents the sodium salt of carboxymethylcellulose, customarily referred to as CMC. The NaCMC used in the dirt mixture shall have a degree of substitution (DS) of 0.6-0.7 and a viscosity of 200-300 cP for a 2 per cent solution at 20° C.

<sup>2</sup> The tolerance on quantity is due to the necessity of obtaining a dirt that correctly spreads out on all the plastic lens.

## Annex 8

### Requirements for road illumination devices (except cornering lamps) incorporating lenses of plastic material - testing of lens or material samples

1. General administrative requirements:
  - 1.1. A test report shall be prepared on the base of this Annex, covering the test and test results as described below for the tests 3.1 to 3.5, which will be added to the test report and the documentation to a specific device for approval.  
The road illumination device used for this test shall be noted in the test report.
  - 1.2. Every application for approval shall be accompanied by:
    - 1.2.1. For the test of plastic material of which the lenses are made: Fourteen lenses;
      - 1.2.1.1. Ten of these lenses may be replaced by ten samples of material at least 60 x 80 mm in size, having a flat or convex outer surface and a substantially flat area (radius of curvature not less than 300 mm) in the middle measuring at least 15 x 15 mm;
      - 1.2.1.2. Every such lens or sample of material shall be produced by the method to be used in mass production;
      - 1.2.2. An optical assembly, if applicable, to which the lenses can be fitted in accordance with the manufacturer's instructions.
      - 1.2.3. For testing the ultraviolet (UV)-resistance of light transmitting components made of plastic material against UV radiation of LED modules inside the headlamp:  
One sample of each of the relevant material as being used in the road illumination device or one road illumination device sample containing these. Each material sample shall have the same appearance and surface treatment, if any, as intended for use in the headlamp to be approved;  
The UV-resistance testing of internal materials to light source radiation is not necessary if no LED modules other than low-UV-types as specified in Annex 9 are being applied or if provisions are taken, to shield the relevant device components from UV radiation, e.g. by glass filters.
2. General requirements
  - 2.1. The samples supplied pursuant to paragraph 1.2. shall satisfy the requirements indicated in paragraphs 3.1. to 3.6.
  - 2.2. The two samples of complete road illumination devices supplied pursuant to paragraph 3.1.2.3. of this Regulation and incorporating lenses of plastic material shall, with regard to the lens material, satisfy the requirements indicated in paragraph 3.7.
  - 2.3. The samples (lenses of plastic material or samples of material) shall be subjected, with the optical assembly to which they are intended to be fitted (where applicable), to approval tests in the chronological order indicated in Table A8-1.
  - 2.4. However, if the lamp manufacturer can prove that the product has already passed the tests prescribed in paragraphs 3.1. to 3.5., or the equivalent tests pursuant to another regulation, those tests need not be repeated; only the tests prescribed in Table A8-2 shall be mandatory.
3. Specific Test Requirements

- 3.1. Resistance to temperature changes
- 3.1.1. Three new samples (lenses) shall be subjected to five cycles of temperature and humidity (RH = relative humidity) change in accordance with the following programme:
- (a) 3 hours at  $40\text{ °C} \pm 2\text{ °C}$  and 85-95 per cent RH;
  - (b) 1 hour at  $23\text{ °C} \pm 5\text{ °C}$  and 60-75 per cent RH;
  - (c) 15 hours at  $-30\text{ °C} \pm 2\text{ °C}$ ;
  - (d) 1 hour at  $23\text{ °C} \pm 5\text{ °C}$  and 60-75 per cent RH;
  - (e) 3 hours at  $80\text{ °C} \pm 2\text{ °C}$ ;
  - (f) 1 hour at  $23\text{ °C} \pm 5\text{ °C}$  and 60-75 per cent RH;
- Before this test, the samples shall be kept at  $23\text{ °C} \pm 5\text{ °C}$  and 60-75 per cent RH for at least four hours.
- Note:* The periods of one hour at  $23\text{ °C} \pm 5\text{ °C}$  shall include the periods of transition from one temperature to another which are needed in order to avoid thermal shock effects.
- 3.1.2. Photometric measurements
- 3.1.2.1. Photometric measurements shall be carried out on the samples before and after the test.
- 3.1.2.2. These measurements shall be made using a standard (étalon) light source and/or LED module(s), or if applicable with a standard gas-discharge light source, as present in the road illumination device, at the following points:
- (a) In the case of AFS, passing-beam of classes C and V and of driving-beam of classes A and B:
    - B50L and 50R for the passing-beam (B50R and 50L in the case of headlamps intended for left-hand traffic);
    - $I_{\max}$  for the driving-beam.
  - (b) In the case of classes BS, CS and DS:
    - B50, 50L and 50R for Class BS headlamp,  $0.86^{\circ}\text{D}/3.5^{\circ}\text{R}$ ,  $0.86^{\circ}\text{D}/3.5^{\circ}\text{L}$ ,  $0.50^{\circ}\text{U}/1.5^{\circ}\text{L}$  and  $0.50^{\circ}\text{U}/1.5^{\circ}\text{R}$  for Class CS and DS headlamps for the passing-beam or a passing/driving lamp;
    - $I_{\max}$  for the driving-beam of a driving lamp or a passing/driving lamp;
  - (c) In the case of front fog lamps:
    - intersection V-V line with line 6 and
    - intersection V-V line with line 4.
- 3.1.2.3. Results
- The variation between the photometric values measured on each sample before and after the test shall not exceed 10 per cent including the tolerances of the photometric procedure.
- 3.2. Resistance to atmospheric and chemical agents
- 3.2.1. Resistance to atmospheric agents
- Three new samples (lenses or samples of material) shall be exposed to radiation from a source having a spectral energy distribution similar to that of a black body at a temperature between 5,500 K and 6,000 K. Appropriate filters shall be placed between the source and the samples so as to reduce as far as possible radiations with wave lengths smaller than 295 nm and greater than

2,500 nm. The samples shall be exposed to an energetic illumination of  $1,200 \text{ W/m}^2 \pm 200 \text{ W/m}^2$  for a period such that the luminous energy that they receive is equal to  $4,500 \text{ MJ/m}^2 \pm 200 \text{ MJ/m}^2$ . Within the enclosure, the temperature measured at the black panel placed on a level with the samples shall be  $50 \text{ }^\circ\text{C} \pm 5 \text{ }^\circ\text{C}$ . In order to ensure a regular exposure, the samples shall revolve around the source of radiation at a speed between 1 and 5 1/min.

The samples shall be sprayed with distilled water of conductivity lower than  $1 \text{ mS/m}$  at a temperature of  $23 \text{ }^\circ\text{C} \pm 5 \text{ }^\circ\text{C}$ , in accordance with the following cycle:  
spraying: 5 minutes; drying: 25 minutes.

### 3.2.2. Resistance to chemical agents

After the test described in paragraph 3.2.1. and the measurement described in paragraph 3.2.3.1. have been carried out, the outer face of the said three samples shall be treated as described in paragraph 3.2.2.2. with the mixture defined in paragraph 3.2.2.1.

#### 3.2.2.1. Test mixture

The test mixture shall be composed of 61.5 per cent n-heptane, 12.5 per cent toluene, 7.5 per cent ethyl tetrachloride, 12.5 per cent trichloroethylene and 6 per cent xylene (volume per cent).

#### 3.2.2.2. Application of the test mixture

Soak a piece of cotton cloth (as per ISO 105) until saturation with the mixture defined in paragraph 3.2.2.1. and, within 10 seconds, apply it for 10 minutes to the outer face of the sample at a pressure of  $50 \text{ N/cm}^2$ , corresponding to an effort of 100 N applied on a test surface of  $14 \times 14 \text{ mm}$ .

During this 10-minute period, the cloth pad shall be soaked again with the mixture so that the composition of the liquid applied is continuously identical with that of the test mixture prescribed.

During the period of application, it is permissible to compensate the pressure applied to the sample in order to prevent it from causing cracks.

#### 3.2.2.3. Cleaning

At the end of the application of the test mixture, the samples shall be dried in the open air and then washed with the solution described in paragraph 3.4.1. (Resistance to detergents) at  $23 \text{ }^\circ\text{C} \pm 5 \text{ }^\circ\text{C}$ .

Afterwards the samples shall be carefully rinsed with distilled water containing not more than 0.2 per cent impurities at  $23 \text{ }^\circ\text{C} \pm 5 \text{ }^\circ\text{C}$  and then wiped off with a soft cloth.

### 3.2.3. Results

#### 3.2.3.1. After the test of resistance to atmospheric agents, the outer face of the samples shall be free from cracks, scratches, chipping and deformation, and the mean

variation in transmission  $\Delta t = \frac{T_2 - T_3}{T_2}$ , measured on the three samples

according to the procedure described in Appendix 2 to this Annex shall not exceed 0.020 ( $\Delta t_m \leq 0.020$ ).

#### 3.2.3.2. After the test of resistance to chemical agents, the samples shall not bear any traces of chemical staining likely to cause a variation of flux diffusion, whose

mean variation  $\Delta d = \frac{T_5 - T_4}{T_2}$ , measured on the three samples according to

the procedure described in Appendix 2 to this Annex shall not exceed 0.020 ( $\Delta d_m \leq 0.020$ ).



### 3.3. Resistance to light source radiations

If necessary, the following test shall be done:

Flat samples of each light transmitting plastic component of the road illumination device are exposed to the light of the light source(s). The parameters such as angles and distances of these samples shall be the same as in the road illumination device. These samples shall have the same colour and surface treatment, if any, as the parts of the road illumination device.

After 1,500 hours of continuous operation, the colorimetric requirements of the transmitted light must be met with a new light source, and the surfaces of the samples shall be free of cracks, scratches, scalings or deformation.

The UV-resistance testing of internal materials to light source radiation is not necessary if light sources according to UN Regulation No. 37 and/or low-UV-type gas discharge light sources and/or low-UV-type LED modules are being applied or if provisions are taken, to shield the relevant system components from UV radiation, e.g. by glass filters.

### 3.4. Resistance to detergents and hydrocarbons

#### 3.4.1. Resistance to detergents

The outer face of three samples (lenses or samples of material) shall be heated to  $50\text{ °C} \pm 5\text{ °C}$  and then immersed for five minutes in a mixture maintained at  $23\text{ °C} \pm 5\text{ °C}$  and composed of 99 parts distilled water containing not more than 0.02 per cent impurities and one part alkylaryl sulphonate.

At the end of the test, the samples shall be dried at  $50\text{ °C} \pm 5\text{ °C}$ . The surface of the samples shall be cleaned with a moist cloth.

#### 3.4.2. Resistance to hydrocarbons

The outer face of these three samples shall then be lightly rubbed for one minute with a cotton cloth soaked in a mixture composed of 70 per cent n-heptane and 30 per cent toluene (volume per cent), and shall then be dried in the open air.

#### 3.4.3. Results

After the above two tests have been performed successively, the mean value of the variation in transmission  $\Delta t = \frac{T_2 - T_3}{T_2}$ , measured on the three samples

according to the procedure described in Appendix 2 shall not exceed 0.010 ( $\Delta t_m \leq 0.010$ ).

### 3.5. Resistance to mechanical deterioration

#### 3.5.1. Mechanical deterioration method

The outer face of the three new samples (lenses) shall be subjected to the uniform mechanical deterioration test by the method described in Appendix 3.

#### 3.5.2. Results

After this test, the variations:

$$\text{in transmission: } \Delta t = \frac{T_2 - T_3}{T_2},$$

$$\text{and in diffusion: } \Delta d = \frac{T_5 - T_4}{T_2},$$

shall be measured according to the procedure described in Appendix 2 in the area specified in paragraph 1.2.1.1. The mean value of the three samples shall be such that:

$$\Delta t_m \leq 0.100;$$

$$\Delta d_m \leq 0.050.$$

- 3.6. Test of adherence of coatings, if any
- 3.6.1. Preparation of the sample
- A surface of 20 mm x 20 mm in area of the coating of a lens shall be cut with a razor blade or a needle into a grid of squares approximately 2 mm x 2 mm. The pressure on the blade or needle shall be sufficient to cut at least the coating.
- 3.6.2. Description of the test
- Use an adhesive tape with a force adhesion of 2 N/(cm of width)  $\pm 20$  per cent measured under the standardized conditions specified in Appendix 4. This adhesive tape, which shall be at least 25 mm wide, shall be pressed for at least five minutes to the surface prepared as prescribed in paragraph 3.6.1.
- Then the end of the adhesive tape shall be loaded in such a way that the force of adhesion to the surface considered is balanced by a force perpendicular to that surface. At this stage, the tape shall be torn off at a constant speed of 1.5 m/s  $\pm 0.2$  m/s.
- 3.6.3. Results
- There shall be no appreciable impairment of the gridded area. Impairments at the intersections between squares or at the edges of the cuts shall be permitted, provided that the impaired area does not exceed 15 per cent of the gridded surface.
- 3.7. Tests of the complete road illumination device incorporating a lens of plastic material.
- 3.7.1. Resistance to mechanical deterioration of the lens surface.
- 3.7.1.1. Tests
- The lens of sample No. 1 shall be subjected to the test described in paragraph 3.5.1. above.
- 3.7.1.2. Results
- 3.7.1.2.1. In the case of AFS, passing-beam of classes C and V and of driving-beam of classes A and B, after the test the results of photometric measurements carried out on the headlamp in accordance with this Regulation shall not exceed:
- (a) By more than 30 per cent the maximum values prescribed at points B50L and HV and by more than 10 per cent below the minimum values prescribed at point 75R (in the case of headlamps intended for left-hand traffic, the points to be considered are B50R, HV and 75L)
- or
- (b) By more than 10 per cent below the minimum values prescribed for HV in the case of a headlamp producing driving-beam only.
- 3.7.1.2.2. In the case of Classes BS, CS and DS, after the test, the results of photometric measurements carried out on the headlamp in accordance with this Regulation shall not exceed:
- (a) By more than 30 per cent the maximum values prescribed at point HV and not be more than 10 per cent below the minimum values prescribed at point 50L and 50R for Class BS headlamp, 0.86°D/3.5°R, 0.86°D/3.5°L for Classes CS and DS headlamp
- or

- (b) By more than 10 per cent below the minimum values prescribed for HV in the case of a headlamp producing driving-beam only.
- 3.7.1.2.3. In the case of fog lamps, after the test, the results of photometric measurements prescribed for lines 2 and 5 shall not exceed the maximum values prescribed by more than 30 per cent
- 3.7.2. Test of adherence of coatings, if any  
The lens of sample No. 2 shall be subjected to the test described in paragraph 3.6.
- 4. Verification of the conformity of production
- 4.1. With regard to the materials used for the manufacture of lenses, the road illumination devices or installation units of a series shall be recognised as complying with this Regulation if:
  - 4.1.1. After the test for resistance to chemical agents and the test for resistance to detergents and hydrocarbons, the outer face of the samples exhibits no cracks, chipping or deformation visible to the naked eye (see paras. 3.2.2., 3.4.1. and 3.4.2.);
  - 4.1.2. After the test described in paragraph 3.7.1.1., the photometric values at the points of measurement considered in paragraph 3.7.1.2. are within the limits prescribed for conformity of production by this Regulation.
- 4.2. If the test results fail to satisfy the requirements, the tests shall be repeated on another sample of road illumination devices selected at random.

## Annex 8 - Appendix 1

### Chronological order of material tests

A. Tests on plastic materials (lenses or samples of material supplied pursuant to paragraph 1.2.).

Table A8-1

#### Chronological order of material tests

<i>Samples</i>	<i>Lenses or samples of material</i>										<i>Lenses</i>			
	<i>1</i>	<i>2</i>	<i>3</i>	<i>4</i>	<i>5</i>	<i>6</i>	<i>7</i>	<i>8</i>	<i>9</i>	<i>10</i>	<i>11</i>	<i>12</i>	<i>13</i>	<i>14</i>
Limited photometry											X	X	X	
Temperature change											X	X	X	
Limited photometry											X	X	X	
Transmission measurement	X	X	X	X	X	X	X	X	X					
Diffusion measurement	X	X	X				X	X	X					
Atmospheric agents	X	X	X											
Transmission measurement	X	X	X											
Chemical agents	X	X	X											
Diffusion measurements	X	X	X											
Detergents				X	X	X								
Hydrocarbons				X	X	X								
Transmission measurement				X	X	X								
Deterioration							X	X	X					
Transmission measurement							X	X	X					
Diffusion measurement							X	X	X					
Adherence														X
Resistance to light source radiations*										X				

\* This test concerns front fog lamps equipped with gas-discharge light sources, headlamps and AFS.

Table A8-2

#### Tests on complete devices, systems or parts thereof (supplied pursuant to paragraph 3.1.2.3. of this Regulation)

<i>Tests</i>	<i>Complete devices, systems or parts thereof</i>	
	<i>Sample No.</i>	
	<i>1</i>	<i>2</i>
Deterioration	X	
Photometry	X	
Adherence		X

## Annex 8 - Appendix 2

### Method of measurement of the diffusion and transmission of light

#### 1. Equipment (see Figure A8-I)

The beam of a collimator K with a half divergence  $\beta/2 = 1.74 \cdot 10^5 \text{rd}$  is limited by a diaphragm  $D_T$  with an opening of 6 mm against which the sample stand is placed.

A convergent achromatic lens  $L_2$ , corrected for spherical aberrations links the diaphragm  $D_T$  with the receiver R; the diameter of the lens  $L_2$  shall be such that it does not diaphragm the light diffused by the sample in a cone with a half top angle of  $\beta/2 = 14^\circ$ .

An annular diaphragm  $D_D$ , with angles  $\alpha_0/2 = 1^\circ$  and  $\alpha_{\max}/2 = 12^\circ$  is placed in an image focal plane of the lens  $L_2$ .

The non-transparent central part of the diaphragm is necessary in order to eliminate the light arriving directly from the light source. It shall be possible to remove the central part of the diaphragm from the light beam in such a manner that it returns exactly to its original position.

The distance  $L_2 D_T$  and the focal length  $F_2^1$  of the lens  $L_2$  shall be so chosen that the image of  $D_T$  completely covers the receiver R.

When the initial incident flux is referred to 1,000 units, the absolute precision of each reading shall be better than 1 unit.

Figure A8-I

#### Optical set up for measurement of variations in diffusion and transmission

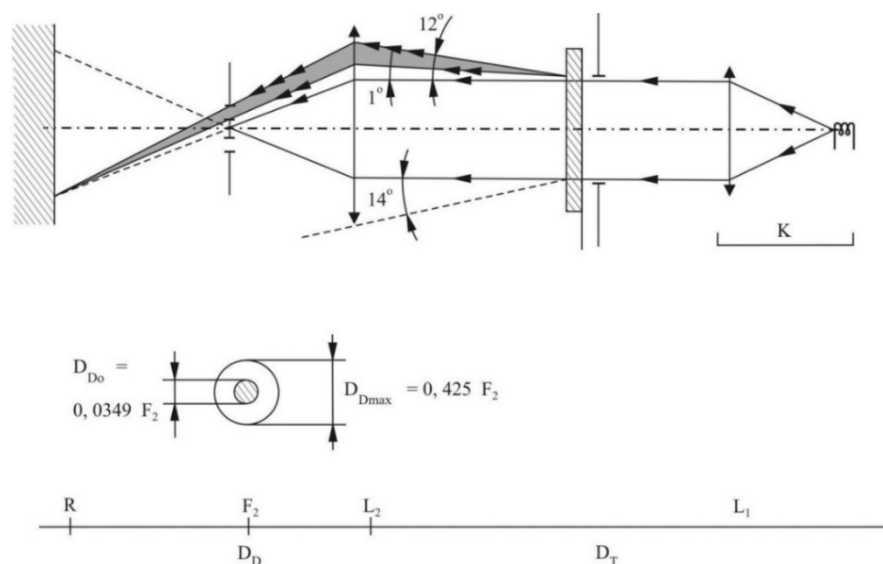

#### 2. Measurements

The following readings shall be taken:

<sup>1</sup> For  $L_2$  it is recommended to use a focal distance of about 80 mm.

Table A8-3  
Readings

<i>Reading</i>	<i>With sample</i>	<i>With central part of <math>D_D</math></i>	<i>Quantity represented</i>
T <sub>1</sub>	No	No	Incident flux in initial reading
T <sub>2</sub>	Yes (before test)	No	Flux transmitted by the new material in a field of 24°
T <sub>3</sub>	Yes (after test)	No	Flux transmitted by the tested material in a field of 24°
T <sub>4</sub>	Yes (before test)	Yes	Flux diffused by the new material
T <sub>5</sub>	Yes (after test)	Yes	Flux diffused by the tested material

## Annex 8 - Appendix 3

### Spray testing method

1. Test equipment

1.1. Spray gun

The spray gun used shall be equipped with a nozzle 1.3 mm in diameter allowing a liquid flow rate of  $0.24 \pm 0.02$  l/minute at an operating pressure of 6.0 bars  $-0/+0.5$  bar.

Under these operation conditions the fan pattern obtained shall be 170 mm 50 mm in diameter on the surface exposed to deterioration, at a distance of 380 mm 10 mm from the nozzle.

1.2. Test mixture

The test mixture shall be composed of:

- (a) Silica sand of hardness 7 on the Mohr scale, with a grain size between 0 and 0.2 mm and an almost normal distribution, with an angular factor of 1.8 to 2;
- (b) Water of hardness not exceeding  $205 \text{ g/m}^3$  for a mixture comprising 25 g of sand per litre of water.

2. Test

The outer surface of the lamp lenses shall be subjected once or more than once to the action of the sand jet produced as described above. The jet shall be sprayed almost perpendicular to the surface to be tested.

The deterioration shall be checked by means of one or more samples of glass placed as a reference near the lenses to be tested. The mixture shall be sprayed until the variation in the diffusion of light on the sample or samples measured by the method described in Appendix 2, is such that:

$$\Delta d = \frac{T_5 - T_4}{T_2} = 0.0250 \pm 0.0025$$

Several reference samples may be used to check that the whole surface to be tested has deteriorated homogeneously.

## Annex 8 - Appendix 4

### Adhesive tape adherence test

1. Purpose  
This method allows to determine under standard conditions the linear force of adhesion of an adhesive tape to a glass plate.
2. Principle  
Measurement of the force necessary to unstick an adhesive tape from a glass plate at an angle of 90°.
3. Specified atmospheric conditions  
The ambient conditions shall be at  $23\text{ °C} \pm 5\text{ °C}$  and  $65 \pm 15$  per cent RH.
4. Test pieces  
Before the test, the sample roll of adhesive tape shall be conditioned for 24 hours in the specified atmosphere (see para. 3. above).  
Five test pieces each 400 mm long shall be tested from each roll. These test pieces shall be taken from the roll after the first three turns were discarded.
5. Procedure  
The test shall be under the ambient conditions specified in paragraph 3.  
Take the five test pieces while unrolling the tape radially at a speed of approximately 300 mm/s, then apply them within 15 seconds in the following manner:  
Apply the tape to the glass plate progressively with a slight length-wise rubbing movement of the finger, without excessive pressure, in such a manner as to leave no air bubble between the tape and the glass plate.  
Leave the assembly in the specified atmospheric conditions for 10 minutes.  
Unstick about 25 mm of the test piece from the plate in a plane perpendicular to the axis of the test piece.  
Fix the plate and fold back the free end of the tape at 90°. Apply force in such a manner that the separation line between the tape and the plate is perpendicular to this force and perpendicular to the plate.  
Pull to unstick at a speed of  $300\text{ mm/s} \pm 30\text{ mm/s}$  and record the force required.
6. Results  
The five values obtained shall be arranged in order and the median value taken as a result of the measurement. This value shall be expressed in Newtons per centimetre of width of the tape.



## Annex 9

### Requirements for LED modules

1. General requirements
    - 1.1. Each LED module sample submitted shall conform to the relevant requirements of this Regulation when tested with the supplied electronic light source control-gear(s), if any.
    - 1.2. LED module(s) shall be so designed as to be and to remain in good working order when in normal use. They shall moreover exhibit no fault in design or manufacture. A LED module shall be considered to have failed if any one of its LEDs has failed.
  2. Manufacture of LED modules
    - 2.1. The LED(s) on the LED module shall be equipped with suitable fixation elements.
    - 2.2. The fixation elements shall be strong and firmly secured to the LED(s) and the LED module.
  3. Test conditions
    - 3.1. Application
      - 3.1.1. All samples shall be tested as specified in paragraph 4.
    - 3.2. Operating conditions
      - 3.2.1. LED module operating conditions
 

All samples shall be tested under the conditions as specified in paragraphs 4.6.2.1.1. and 4.6.2.2.1. of this Regulation.
      - 3.2.2. Ambient temperature
 

For the measurement of electrical and photometric characteristics, the device shall be operated in a dry and still atmosphere at an ambient temperature of  $23\text{ }^{\circ}\text{C} \pm 5\text{ }^{\circ}\text{C}$ .
    - 3.3. Ageing
 

Upon the request of the applicant the LED module shall be operated for 15 h and cooled down to ambient temperature before starting the tests as specified in this Regulation.
4. Specific requirements and tests
  - 4.1. Colour rendering
    - 4.1.1. Red content
 

In addition to provisions as described in paragraph 4.16. of this Regulation.

The minimum red content of the light of a LED module, when tested outside the device, shall be such that:

$$k_{\text{red}} = \frac{\int_{\lambda=610\text{ nm}}^{780\text{ nm}} E_e(\lambda) V(\lambda) d\lambda}{\int_{\lambda=380\text{ nm}}^{780\text{ nm}} E_e(\lambda) V(\lambda) d\lambda} \geq 0.05$$

where:

$E_e(\lambda)$  (unit: W) is the spectral distribution of the irradiance;

$V(\lambda)$  (unit: 1) is the spectral luminous efficiency;

$\lambda$  (unit: nm) is the wavelength.

This value shall be calculated using intervals of one nanometre.

4.2. UV-radiation

The UV-radiation of a low-UV-type LED module, when tested outside the device, shall be such that:

$$k_{UV} = \frac{\int_{\lambda=250\text{nm}}^{400\text{nm}} E_e(\lambda) S(\lambda) d\lambda}{k_m \int_{\lambda=380\text{nm}} E_e(\lambda) V(\lambda) d\lambda} \leq 10^{-5} \text{ W / lm}$$

where:

$S(\lambda)$  (unit: 1) is the spectral weighting function;

$k_m = 683 \text{ lm/W}$  is the maximum value of the luminous efficacy of radiation.

(For definitions of the other symbols see paragraph 4.1.1.).

This value shall be calculated using intervals of one nanometre. The UV-radiation shall be weighted according to the values as indicated Table A9-1:

Table A9-1

**Table UV**

Values according to "IRPA/INIRC Guidelines on limits of exposure to ultraviolet radiation". Wavelengths (in nanometres) chosen are representative; other values should be interpolated.

$\lambda$	$S(\lambda)$	$\lambda$	$S(\lambda)$	$\lambda$	$S(\lambda)$
250	0.430	305	0.060	355	0.000 16
255	0.520	310	0.015	360	0.000 13
260	0.650	315	0.003	365	0.000 11
265	0.810	320	0.001	370	0.000 09
270	1.000	325	0.000 50	375	0.000 077
275	0.960	330	0.000 41	380	0.000 064
280	0.880	335	0.000 34	385	0.000 053
285	0.770	340	0.000 28	390	0.000 044
290	0.640	345	0.000 24	395	0.000 036
295	0.540	350	0.000 20	400	0.000 030
300	0.300				

- 5. The measurement of the objective luminous flux of LED module(s) producing the principal passing-beam shall be carried out as follows:
  - 5.1. The LED module(s) shall be in the configuration as described in the technical specification as defined in paragraph 3.1.2.2. of this Regulation. Optical elements (secondary optics) shall be removed by the Technical Service at the request of the applicant by the use of tools. This procedure and the conditions during the measurements as described below shall be described in the test report.
  - 5.2. One module of each type shall be submitted by the applicant with the electronic light source control gear, if applicable, and sufficient instructions.

Suitable thermal management (e.g. heat sink) may be provided, to simulate similar thermal conditions as in the corresponding headlamp or AFS application.

Before the test each LED module shall be aged at least for seventy-two hours under the same conditions as in the corresponding headlamp application.

In the case of use of an integrating sphere, the sphere shall have a minimum diameter of one meter, and at least ten times the maximum dimension of the LED module, whichever is the largest. The flux measurements can also be performed by integration using a goniophotometer. The prescriptions in CIE - Publication 84 - 1989, regarding the room temperature, positioning, etc., shall be taken into consideration.

The LED module shall be burned in for approximately one hour in the closed sphere or goniophotometer.

The flux shall be measured after photometric stability has occurred.

## Annex 10

### Testing procedures with respect to light sources

1. General test requirements
  - 1.1. The luminous intensity distribution and the colour of the light emitted are measured and checked for compliance after photometric stability (as defined in UN Regulation No. 48).
  - 1.2. For lamps (functions) using light source technologies other than incandescent technology only:
    - 1.2.1. For cornering lamps, the luminous intensities measured after 1 minute and after 10 minutes of operation, shall comply with the minimum and maximum requirements. The luminous intensity distribution after 1 and after 10 minutes of operation may be calculated from the luminous intensity distribution measured after photometric stability has occurred by applying at each test point the ratio of luminous intensities measured at 45°L 2.5°D for a left-side lamp (the L angle should be substituted for the R angle for a right-side lamp):
      - (a) After 1 minute;
      - (b) After 10 minutes; and
      - (c) After photometric stability has occurred.
    - 1.2.2. For all other lamps, the luminous intensities measured after 1 min and after photometric stability shall comply with the minimum and maximum requirements.
 

The luminous intensity distribution after 1 min of operation may be calculated from the luminous intensity distribution after photometric stability by applying at each test point the ratio of luminous intensities measured at the test point according to Table A10-1 after 1 min and after photometric stability.
2. Additional test requirements
  - 2.1. Depending on the light source technology and on the lamp (function) the luminous intensity distribution is, in addition to paragraph 1, checked for compliance at the point in time listed in Table A10-1.
 

The luminous intensity distributions at a point in time may be calculated from the luminous intensity distribution measured after photometric stability by applying, at each test element in the light distribution, the ratio of luminous intensities measured at the test point of the lamp (function) under consideration.

Table A10-1

#### Points in time for additional testing

<i>Lamp (function)</i>	<i>Time after activation (seconds)</i>	<i>Test point</i>
Driving-beam (Headlamp producing only driving-beam)	1	HV
Passing-beam <sup>a</sup>	4	50V
AFS class C <sup>a</sup>	4	50V
Front fog	4	H, 2.5°D
Cornering lamp	1	45°L 2.5°D resp. 45°R 2.5°D

<sup>a</sup> After 1 second it shall meet at least 25 % of the requirement at the test point

- 2.1.1. In case a lamp (function) uses incandescent technology only, the lamp (function) is deemed to comply with the corresponding intensity requirements at all points in time, if the values measured after photometric stability are compliant.
- 2.1.2. In case a lamp (function) uses gas-discharge technology only, a lamp (function) is deemed to comply with the corresponding intensity requirements at all points in time, if the values measured at the point in time according to Table A10-1 and after photometric stability are compliant.
- 2.1.3. In case a lamp (function) uses LED technology only, a lamp (function) is deemed to comply with the corresponding intensity requirements at all points in time, if the values measured at 1 minute after activation and after photometric stability are compliant.
- 2.1.4. In case of any other light generating technology, the corresponding intensity requirements of a lamp (function) are tested and checked for compliance at all points in time starting at the corresponding point in time listed in Table A10-1 and ending when photometric stability is reached.
- 2.1.5. In case a lamp (function) uses more than one light generating technology, the corresponding intensity requirements of a lamp (function) are tested following the strictest time requirements according to paragraphs 2.1.1. to 2.1.4. for the combination of them and checked for compliance.
- 2.1.6. In case of doubt (e.g. unexpected run-up behaviour), the corresponding minimum intensity requirements of a lamp (function) are additionally tested and checked for compliance at all points in time starting at the corresponding point in time listed in Table A10-1.

## Annex 11

### Centre of reference

In the case it is used:

Figure A11-I  
Centre of reference

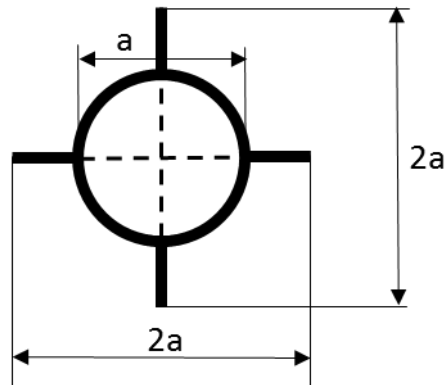

$a = 2 \text{ mm min.}$

This optional mark of the centre of reference shall be positioned on the lens at its intersection with the reference axis of the passing-beam and also on the lenses of the driving beams and/or cornering lamps when they are neither grouped nor combined nor reciprocally incorporated with a passing-beam and on the lens of a front fog lamp.

Figure A11-I represents the mark of the centre of reference as projected on a plane substantially tangent to the lens about the centre of the circle. The lines constituting this mark may either be solid or dotted.

## Annex 12

### Voltage markings

Figure A12-I  
Voltage  
marking A

nn V

This marking must be placed on the main body of each headlamp containing only gas discharge light sources and ballast, and on each external part of the ballast.

The ballast(s) is(are) designed for a network system of nn Volts.

Figure A12-II  
Voltage  
marking B

nn  $\overline{24}$  V

This marking must be placed on the main body of each headlamp containing at least one gas discharge light source and ballast.

The ballast(s) is(are) designed for a network system of nn Volts.



None of the filament light sources which the headlamp contains is designed for a 24 Volts network system.

## Annex 13

## Arrangement of approval markings

The following approval marking arrangements are given merely as examples and any other arrangement made in accordance with paragraph 3.3. of this Regulation is acceptable.

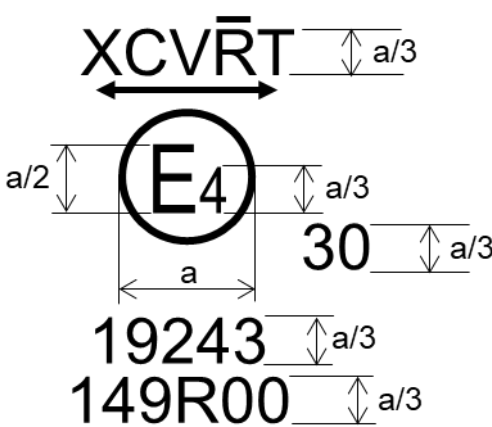
## 1. Approval marking of a single road illumination device

<p>Figure A13-I - Marking example 1</p>  <p>a = see Par. 3.3.1.2.1. of this Regulation</p>	<p>The device bearing the approval marking shown on the left is an installation unit of an AFS approved in the Netherlands (E4) under approval number 19243 pursuant to this Regulation.</p> <p>The number after 149R indicates that approval was granted in accordance with the requirements of this Regulation in its original form (00).</p> <p>The functions identification symbols show that the approval was granted in respect of the driving-beam (R) and the Class C and Class V passing-beam. The double pointed arrow shows that the passing-beam is suitable for both traffic systems by means of an appropriate adjustment of the setting of the optical element or the light source on the vehicle. Class C passing-beam, Class V passing-beam and driving-beam comply to bending lighting provisions, as indicated by the letter "T". The score above the letter "R" indicates that the driving-beam function is provided by more than one installation unit on that side of the system.</p> <p>Number 30 indicates that the maximum luminous intensity of the driving-beam is between 123,625 and 145,125 candelas.</p>
<p>Figure A13-II - Marking example 2</p> 	<p>The lamp bearing the approval marking shown on the left is a passing-beam headlamp (C) for left-hand traffic only (arrow) using a plastic lens (PL) approved in Austria (E12) pursuant to this Regulation 149R as amended by the 01 series of amendments (01) combined with a front position lamp (A) as set in the original series of amendments (00) of the Regulation on Light Signalling Devices 148R. Both lamps (functions) are approved under approval number 4554.</p>



## 2. Approval marking of grouped, combined or reciprocally incorporated lamps

*Note:* The vertical and horizontal lines schematize the shape of the light-signalling lamp. These lines are not part of the approval marking.

Figure A13-III

**Marking example 3-a**

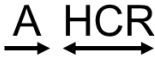
17120 (E <sub>1</sub> ) 30 148R00 149R00	A HCR F3 PL 	1a
---	--	----

**Marking example 3-b**

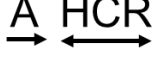
A HCR F3 PL 1a  17120 148R00 (E <sub>1</sub> ) 30 149R00	
---	--

*Note:* The examples 3-a and 3-b in Figure A13-III correspond to a lighting device bearing an approval marking comprising:

- (a) A front position lamp approved in accordance with the 00 series of amendments to UN Regulation No. 148. The horizontal arrow indicates the side on which the required photometric specifications are met up to an angle of 80° H;
- (b) A headlamp, Class B, with a passing-beam designed for right-hand traffic only and a driving-beam with a maximum intensity comprised between 123,625 and 145,125 candelas (as indicated by the number 30), approved in accordance with the requirements of this Regulation, as amended by the 00 series of amendments and incorporating a lens of plastic material;
- (c) A front fog lamp approved in accordance with the 00 series of amendments of this Regulation and incorporating a lens of plastic material;
- (d) A front direction indicator lamp of category 1a approved in accordance with the 00 series of amendments to UN Regulation No. 148.

Figure A13-IV  
**Marking example 4**

This example corresponds to an adaptive front-lighting system composed of two installation units for the left side of the vehicle and one installation unit for the right side.

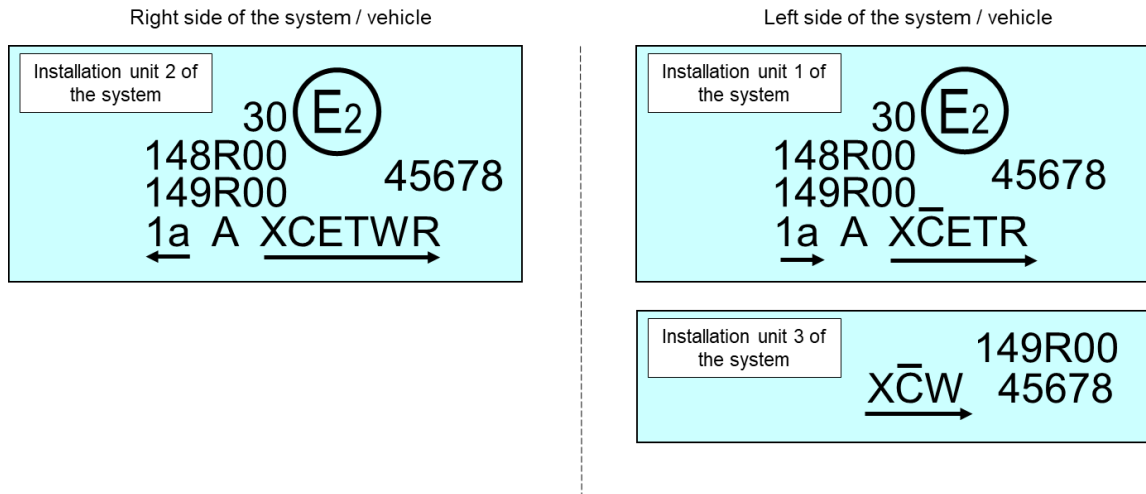

The system bearing the above approval markings meets the requirements of this Regulation (original version of the Regulation) in respect of both a passing-beam for left-hand traffic and a driving-beam with a maximum intensity comprised between 123,625 and 145,125 candelas (as indicated by the number 30) grouped with a front direction indicator lamp of category 1a and a front position lamp approved in accordance with the 00 series of amendments of UN Regulation No. 148.

The installation unit 1 of the system (left side) is designed to contribute to the Class C passing-beam and the Class E passing-beam. The score above the letter "C" indicates that on that side more than one installation unit contributes to the Class C passing-beam. The letter "T" to the right following the listed symbols indicates that each, the Class C passing-beam and the Class E passing-beam are providing a bending mode.

The installation unit 3 of the system (left side) is designed to provide the second part of the Class C passing-beam of that side (as indicated by the score above the letter "C") and a Class W passing-beam. For this additional lighting unit, a circle surrounding the letter "E" followed by the distinguishing number of the country is not necessary.

The installation unit 2 of the system (right side) is designed to contribute to the Class C passing-beam, a Class E passing-beam, both with bending mode and a Class W passing-beam.

*Note:* In the above example, the different installation units of the system shall bear the same approval number.

3. Identification code of light source modules

Figure A13-V  
**Light source module marking example**

**MD E3 17325**

The light source module bearing the identification code shown in Figure A13-V has been approved together with a lamp approved in Italy (E3) under approval number 17325.

4. Additional lighting units designed to provide bend lighting

Figure A13-VI

**Lighting unit marking example**

**ALU E43 1234**

The additional lighting unit bearing the identification code shown in Figure A13-VI has been approved together with a headlamp initially approved in Japan (E43) under approval number 1234.

## Annex 14

### Description forms

Maximum format: A4 (210 x 297 mm)

#### Adaptive front-lighting system description form No. 1

#### AFS control signals relevant to the lighting functions, and modes of functions provided by the system

AFS Control Signal	Function/mode(s) of, being influenced by the signal <sup>1</sup>					Technical characteristics <sup>2</sup> (use separate sheet, if needed)
	Passing-beam				Driving-beam	
	Class C	Class V	Class E	Class W		
None / default	<input checked="" type="checkbox"/>				<input type="checkbox"/>	
V-Signal	<input type="checkbox"/>	<input type="checkbox"/>	<input type="checkbox"/>	<input type="checkbox"/>	<input type="checkbox"/>	
E-Signal	<input type="checkbox"/>	<input type="checkbox"/>	<input type="checkbox"/>	<input type="checkbox"/>	<input type="checkbox"/>	
W-Signal	<input type="checkbox"/>	<input type="checkbox"/>	<input type="checkbox"/>	<input type="checkbox"/>	<input type="checkbox"/>	
T-Signal	<input type="checkbox"/>	<input type="checkbox"/>	<input type="checkbox"/>	<input type="checkbox"/>	<input type="checkbox"/>	
Other Signals <sup>3</sup>	<input type="checkbox"/>	<input type="checkbox"/>	<input type="checkbox"/>	<input type="checkbox"/>	<input type="checkbox"/>	

<sup>1</sup> Mark in the respective box(es) with an cross (X) the combination(s) which apply.

<sup>2</sup> To be indicated in terms of:

- (a) Physical nature (electrical current/ voltage, optical, mechanical, hydraulic, pneumatic, ...).
- (b) Information type (continuous/analogous, binary, digitally coded,..).
- (c) Time dependent properties (time constant, resolution, ..).
- (d) Signal status when the respective conditions according to paragraph 6.22.7.4. of UN Regulation No. 48 are fulfilled.
- (e) Signal status in case of failure (with reference to the system input).

<sup>3</sup> According to the applicants description; use separate sheet, if needed.

**Adaptive front-lighting system description form No. 2**  
**Cut-off status, adjustment devices and adjustment procedures relevant to the lighting units**

<i>Lighting unit No.<sup>4</sup></i>	<i>Cut-off status<sup>5</sup></i>		<i>Adjustment device</i>				<i>Characteristics &amp; additional provisions(if any)<sup>8</sup></i>
	<i>The lighting unit provides or contributes to one or more passing-beam cut-off(s),</i>		<i>vertical</i>		<i>horizontal</i>		
	<i>as defined in Annex 5 to this Regulation<sup>6</sup></i>	<i>and provisions of paragraph 5.3.5.1. of this Regulation apply<sup>6</sup></i>	<i>Individual ("master")<sup>6,9</sup></i>	<i>linked to "master" unit No.<sup>7</sup></i>	<i>Individual ("master")<sup>6,9</sup></i>	<i>linked to "master" unit No.<sup>7</sup></i>	
1	yes / no	yes / no	yes / no	....	yes / no	....	
2	yes / no	yes / no	yes / no	....	yes / no	....	
3	yes / no	yes / no	yes / no	....	yes / no	....	
4	yes / no	yes / no	yes / no	....	yes / no	....	
5	yes / no	yes / no	yes / no	....	yes / no	....	
6	yes / no	yes / no	yes / no	....	yes / no	....	
7	yes / no	yes / no	yes / no	....	yes / no	....	

- <sup>4</sup> Designation of each individual lighting unit of the system as indicated in Annex 1 to this Regulation and as shown in the drawing according to paragraph 3.1.2. of this Regulation; use separate sheet(s) if needed.
- <sup>5</sup> Relevant to provisions of paragraph 6.22.6.1.2. of UN Regulation No. 48.
- <sup>6</sup> Strike out what does not apply.
- <sup>7</sup> Indicate corresponding lighting unit(s) number(s), if applicable.
- <sup>8</sup> Information such as e.g.: the order of adjustment of lighting units or assemblies of lighting units, any additional provisions for the adjustment process.
- <sup>9</sup> The adjustment of a "master" lighting unit may also adjust (an) other lighting unit(s).

"

## II. Justification

1. This proposal represents the agreed deliverable for Stage 2 / Step 1 of the simplification of the lighting and light-signalling Regulations (SLR), as indicated in the updated Terms of Reference and Rules of Procedure for the Informal Working Group "Simplification of the Lighting and Light-Signalling UN Regulations" (IWG SLR) (Annex II to ECE/TRANS/WP.29/GRE/80).
  2. The objective of this proposal is to introduce a new series of amendments to UN Regulation No. 149, thus increasing the clarity of the text and introducing performance-based requirements.
  3. This objective has been achieved by completely rewriting the whole UN Regulation and presenting it as a fully consolidated "clean" text to improve its readability. This document format has been chosen and agreed by all experts (both from Contracting Parties and non-governmental organizations (NGOs)) participating in IWG SLR, also in order to lessen the burden (especially for the Secretariat) and to enhance the quality (less chance to make mistakes in the "transition" from 00 to 01 series of amendments).
  4. Furthermore, this new series of amendments deals with the identified amendments and clarifications to this Regulation in order to achieve, to the current maximum possible extent, the goal of being technologically neutral, performance based and able to be tested objectively. It is accompanied by parallel amendments to UN Regulations regarding the installation of lighting and light-signalling devices (Nos. 48, 53, 74 and 86) to reflect any necessary changes induced by this new series of amendments.
  5. Finally, during the process, adaptation to the technical progress was included and requirements were made future proof, whenever possible.
  6. This draft proposal is accompanied by a presentation to highlight the major changes during the transition process. Such a presentation is available as informal document GRE-85-04.
-