

13 September 2017

---

## **Agreement**

### **Concerning the Adoption of Uniform Technical Prescriptions for Wheeled Vehicles, Equipment and Parts which can be Fitted and/or be Used on Wheeled Vehicles and the Conditions for Reciprocal Recognition of Approvals Granted on the Basis of these Prescriptions\***

(Revision 2, including the amendments which entered into force on 16 October 1995)

---

#### **Addendum 136 – Regulation No. 137**

#### **Revision 1**

Incorporating all valid text up to:

01 series of amendments to the Regulation - Date of entry into force: 17 December 2016

#### **Uniform provisions concerning the approval of passenger cars in the event of a frontal collision with focus on the restraint system**

This document is meant purely as documentation tool. The authentic and legal binding text of the revision is: ECE/TRANS/WP.29/2015/106.



**UNITED NATIONS**

---

\* Former title of the Agreement: Agreement Concerning the Adoption of Uniform Conditions of Approval and Reciprocal Recognition of Approval for Motor Vehicle Equipment and Parts, done at Geneva on 20 March 1958.



## Regulation No. 137

### Uniform provisions concerning the approval of passenger cars in the event of a frontal collision with focus on the restraint system

#### Contents

	<i>Page</i>
Regulation	
1. Scope .....	5
2. Definitions.....	5
3. Application for approval .....	8
4. Approval .....	8
5. Specifications .....	9
6. Instructions for users of vehicles equipped with airbags.....	14
7. Modification and extension of approval of the vehicle type .....	16
8. Conformity of production.....	17
9. Penalties for non-conformity of production .....	17
10. Production definitively discontinued.....	17
11. Transitional provisions.....	18
12. Names and addresses of Technical Services responsible for conducting approval tests, and of Type Approval Authorities.....	18
Annexes	
1 Communication.....	19
2 Arrangements of approval marks .....	21
3 Test procedure.....	22
4 Performance criteria .....	28
5 Arrangement and installation of dummies and adjustment of restraint systems .....	30
6 Procedure for determining the "H" point and the actual torso angle for seating positions in motor vehicles .....	37
Appendix 1 - Description of the three dimensional "H" point machine (3-D H machine).....	37
Appendix 2 - Three-dimensional reference system.....	37
Appendix 3 - Reference data concerning seating positions.....	37

7	Test procedure with trolley .....	38
	Appendix - Equivalence curve - tolerance band for curve $\Delta V = f(t)$ .....	40
8	Technique of measurement in measurement tests: Instrumentation .....	41
9	Test procedures for the protection of the occupants of vehicles operating on electrical power from high voltage and electrolyte spillage .....	46
	Appendix - Jointed test finger (IPXXB).....	52

## 1. Scope

This Regulation applies to vehicles of category M<sub>1</sub><sup>1</sup> with a maximum permissible mass below 3.5 tonnes; other vehicles may be approved at the request of the manufacturer.

## 2. Definitions

For the purpose of this Regulation:

- 2.1. "*Protective system*" means interior fittings and devices intended to restrain the occupants and contribute towards ensuring compliance with the requirements set out in paragraph 5. below.
- 2.2. "*Type of protective system*" means a category of protective devices which do not differ in such essential respects as their:
  - (a) Technology;
  - (b) Geometry;
  - (c) Constituent materials.
- 2.3. "*Vehicle width*" means the distance between two planes parallel to the longitudinal median plane (of the vehicle) and touching the vehicle on either side of the said plane but excluding the external devices for indirect vision, side marker lamps, tyre pressure indicators, direction indicator lamps, position lamps, flexible mud-guards and the deflected part of the tyre side-walls immediately above the point of contact with the ground.
- 2.4. "*Vehicle type*" means a category of power-driven vehicles which do not differ in such essential respects as:
  - 2.4.1. The length and width of the vehicle, in so far as they have a negative effect on the results of the impact test prescribed in this Regulation;
  - 2.4.2. The structure, dimensions, lines and materials of the part of the vehicle forward of the transverse plane through the "R" point of the driver's seat, in so far as they have a negative effect on the results of the impact test prescribed in this Regulation;
  - 2.4.3. The lines and inside dimensions of the passenger compartment and the type of protective system, in so far as they have a negative effect on the results of the impact test prescribed in this Regulation;
  - 2.4.4. The siting (front, rear or centre) and the orientation (transversal or longitudinal) of the engine, in so far as they have a negative effect on the result of the impact test procedure as prescribed in this Regulation;
  - 2.4.5. The unladen mass, in so far as there is a negative effect on the result of the impact test prescribed in this Regulation;
  - 2.4.6. The optional arrangements or fittings provided by the manufacturer, in so far

---

<sup>1</sup> As defined in the Consolidated Resolution on the Construction of Vehicles (R.E.3.), document ECE/TRANS/WP.29/78/Rev.6, para. 2 - [www.unece.org/trans/main/wp29/wp29wgs/wp29gen/wp29resolutions.html](http://www.unece.org/trans/main/wp29/wp29wgs/wp29gen/wp29resolutions.html)

- as they have a negative effect on the result of the impact test prescribed in this Regulation;
- 2.4.7. The locations of the REESS, in so far as they have a negative effect on the result of the impact test prescribed in this Regulation.
- 2.5. Passenger compartment
- 2.5.1. "*Passenger compartment with regard to occupant protection*" means the space for occupant accommodation, bounded by the roof, floor, side walls, doors, outside glazing and front bulkhead and the plane of the rear compartment bulkhead or the plane of the rear-seat back support;
- 2.5.2. "*Passenger compartment for electric safety assessment*" means the space for occupant accommodation, bounded by the roof, floor, side walls, doors, outside glazing, front bulkhead and rear bulkhead, or rear gate, as well as by the electrical protection barriers and enclosures provided for protecting the occupants from direct contact with high voltage live parts.
- 2.6. "*R point*" means a reference point defined for each seat by the manufacturer in relation to the vehicle's structure, as indicated in Annex 6.
- 2.7. "*H point*" means a reference point determined for each seat by the testing service responsible for approval, in accordance with the procedure described in Annex 6.
- 2.8. "*Unladen kerb mass*" means the mass of the vehicle in running order, unoccupied and unladen but complete with fuel, coolant, lubricant, tools and a spare wheel (if these are provided as standard equipment by the vehicle manufacturer).
- 2.9. "*Airbag*" means a device installed to supplement safety belts and restraint systems in power-driven vehicles, i.e. systems which, in the event of a severe impact affecting the vehicle, automatically deploy a flexible structure intended to limit, by compression of the gas contained within it, the gravity of the contacts of one or more parts of the body of an occupant of the vehicle with the interior of the passenger compartment.
- 2.10. "*Passenger airbag*" means an airbag assembly intended to protect occupant(s) in seats other than the driver's in the event of a frontal collision.
- 2.11. "*High voltage*" means the classification of an electric component or circuit, if its working voltage is  $> 60 \text{ V}$  and  $\leq 1,500 \text{ V}$  direct current (DC) or  $> 30 \text{ V}$  and  $\leq 1,000 \text{ V}$  alternating current (AC) root – mean – square (rms).
- 2.12. "*Rechargeable Electrical Energy Storage System (REESS)*" means the rechargeable electrical energy storage system which provides electrical energy for propulsion.
- 2.13. "*Electrical protection barrier*" means the part providing protection against any direct contact to the high voltage live parts.
- 2.14. "*Electrical power train*" means the electrical circuit which includes the traction motor(s), and may also include the REESS, the electrical energy conversion system, the electronic converters, the associated wiring harness and connectors, and the coupling system for charging the REESS.
- 2.15. "*Live parts*" means conductive part(s) intended to be electrically energized in normal use.

- 2.16. "*Exposed conductive part*" means the conductive part which can be touched under the provisions of the protection IPXXB and which becomes electrically energized under isolation failure conditions. This includes parts under a cover that can be removed without using tools.
- 2.17. "*Direct contact*" means the contact of persons with high voltage live parts.
- 2.18. "*Indirect contact*" means the contact of persons with exposed conductive parts.
- 2.19. "*Protection IPXXB*" means protection from contact with high voltage live parts provided by either an electrical protection barrier or an enclosure and tested using a Jointed Test Finger (IPXXB) as described in paragraph 4. of Annex 11.
- 2.20. "*Working voltage*" means the highest value of an electrical circuit voltage root-mean-square (rms), specified by the manufacturer, which may occur between any conductive parts in open circuit conditions or under normal operating conditions. If the electrical circuit is divided by galvanic isolation, the working voltage is defined for each divided circuit, respectively.
- 2.21. "*Coupling system for charging the Rechargeable Electrical Energy Storage System (REESS)*" means the electrical circuit used for charging the REESS from an external electrical power supply including the vehicle inlet.
- 2.22. "*Electrical chassis*" means a set made of conductive parts electrically linked together, whose electrical potential is taken as reference.
- 2.23. "*Electrical circuit*" means an assembly of connected high voltage live parts which is designed to be electrically energized in normal operation.
- 2.24. "*Electrical energy conversion system*" means a system (e.g. fuel cell) that generates and provides electrical energy for electrical propulsion.
- 2.25. "*Electronic converter*" means a device capable of controlling and/or converting electrical power for electrical propulsion.
- 2.26. "*Enclosure*" means the part enclosing the internal units and providing protection against any direct contact.
- 2.27. "*High voltage bus*" means the electrical circuit, including the coupling system for charging the REESS that operates on a high voltage.
- 2.28. "*Solid insulator*" means the insulating coating of wiring harnesses, provided in order to cover and prevent the high voltage live parts from any direct contact. This includes covers for insulating the high voltage live parts of connectors; and varnish or paint for the purpose of insulation.
- 2.29. "*Automatic disconnect*" means a device that when triggered, galvanically separates the electrical energy sources from the rest of the high voltage circuit of the electrical power train.
- 2.30. "*Open type traction battery*" means a type of battery requiring liquid and generating hydrogen gas released to the atmosphere.
- 2.31. "*Automatically activated door locking system*" means a system that locks the doors automatically at a pre-set speed or under any other condition as defined by the manufacturer.

### **3. Application for approval**

- 3.1. The application for approval of a vehicle type with regard to the protection of the occupants of the front seats in the event of a frontal collision shall be submitted by the vehicle manufacturer or by their duly accredited representative.
- 3.2. It shall be accompanied by the undermentioned documents in triplicate and following particulars:
  - 3.2.1. A detailed description of the vehicle type with respect to its structure, dimensions, lines and constituent materials;
  - 3.2.2. Photographs, and/or diagrams and drawings of the vehicle showing the vehicle type in front, side and rear elevation and design details of the forward part of the structure;
  - 3.2.3. Particulars of the vehicle's unladen kerb mass;
  - 3.2.4. The lines and inside dimensions of the passenger compartment;
  - 3.2.5. A description of the interior fittings and protective systems installed in the vehicle;
  - 3.2.6. A general description of the electrical power source type, location and the electrical power train (e.g. hybrid, electric).
- 3.3. The applicant for approval shall be entitled to present any data and results of tests carried out which make it possible to establish that compliance with the requirements can be achieved with a sufficient degree of confidence.
- 3.4. A vehicle which is representative of the type to be approved shall be submitted to the Technical Service responsible for conducting the approval tests.
  - 3.4.1. A vehicle not comprising all the components proper to the type may be accepted for test provided that it can be shown that the absence of the components has no detrimental effect on the results of the test in so far as the requirements of this Regulation are concerned.
  - 3.4.2. It shall be the responsibility of the applicant for approval to show that the application of paragraph 3.4.1. above is compatible with compliance with the requirements of this Regulation.

### **4. Approval**

- 4.1. If the vehicle type submitted for approval pursuant to this Regulation meets the requirements of this Regulation, approval of that vehicle type shall be granted.
  - 4.1.1. The Technical Service appointed in accordance with paragraph 12. below shall check whether the required conditions have been satisfied.
  - 4.1.2. In case of doubt, account shall be taken, when verifying the conformity of the vehicle to the requirements of this Regulation, of any data or test results provided by the manufacturer which can be taken into consideration in validating the approval test carried out by the Technical Service.



- 4.2. An approval number shall be assigned to each type approved. Its first two digits (at present 01 corresponding to the 01 series of amendments) shall indicate the series of amendments incorporating the most recent major technical amendments made to the Regulation at the time of issue of the approval. The same Contracting Party may not assign the same approval number to another vehicle type.
- 4.3. Notice of approval or of refusal of approval of a vehicle type pursuant to this Regulation shall be communicated by the Parties to the Agreement which apply this Regulation by means of a form conforming to the model in Annex 1 to this Regulation and photographs and/or diagrams and drawings supplied by the applicant for approval, in a format not exceeding A4 (210 x 297 mm) or folded to that format and on an appropriate scale.
- 4.4. There shall be affixed, conspicuously and in a readily accessible place specified on the approval form, to every vehicle conforming to a vehicle type approved under this Regulation, an international approval mark consisting of:
- 4.4.1. A circle surrounding the letter "E" followed by the distinguishing number of the country which has granted approval;<sup>2</sup>
- 4.4.2. The number of this Regulation, followed by the letter "R", a dash and the approval number, to the right of the circle prescribed in paragraph 4.4.1. above.
- 4.5. If the vehicle conforms to a vehicle type approved, under one or more other Regulations annexed to the Agreement, in the country which has granted approval under this Regulation, the symbol prescribed in paragraph 4.4.1. above need not be repeated; in such a case the Regulation and approval numbers and the additional symbols of all the Regulations under which approval has been granted in the country which has granted approval under this Regulation shall be placed in vertical columns to the right of the symbol prescribed in paragraph 4.4.1.
- 4.6. The approval mark shall be clearly legible and be indelible.
- 4.7. The approval mark shall be placed close to or on the vehicle data plate affixed by the manufacturer.
- 4.8. Annex 2 to this Regulation gives examples of approval marks.

## **5. Specifications**

- 5.1. General specifications
- 5.1.1. The "H" point for each seat shall be determined in accordance with the procedure described in Annex 6.
- 5.1.2. When the protective system for the front seating positions includes belts, the belt components shall meet the requirements of Regulation No. 16.

---

<sup>2</sup> The distinguishing numbers of the Contracting Parties to the 1958 Agreement are reproduced in Annex 3 to the Consolidated Resolution on the Construction of Vehicles (R.E.3), document ECE/TRANS/WP.29/78/Rev. 6 - [www.unece.org/trans/main/wp29/wp29wgs/wp29gen/wp29resolutions.html](http://www.unece.org/trans/main/wp29/wp29wgs/wp29gen/wp29resolutions.html)

- 5.1.3. Seating positions where a dummy is installed and the protective system includes belts, shall be provided with anchorage points conforming to Regulation No. 14.
- 5.2. Specifications for the restraint system test (Full Width Rigid Barrier test)
- The vehicle shall be tested and approved in accordance with the method described in Annex 3.
- The vehicle which, in agreement with the Technical Service, is considered as having the worst case effect on the result of the injury criteria specified in paragraph 5.2.1. shall be selected for this test.
- The test of the vehicle carried out in accordance with the method described in Annex 3. shall be considered satisfactory if all the conditions set out in paragraphs 5.2.1. to 5.2.6. below are all satisfied at the same time.
- Additionally, vehicles equipped with electric power train shall meet the requirements of paragraph 5.2.8. This can be met by a separate impact test at the request of the manufacturer and after validation by the Technical Service, provided that the electrical components do not influence the occupant protection performance of the vehicle type as defined in paragraphs 5.2.1. to 5.2.5. of this Regulation. In case of this condition the requirements of paragraph 5.2.8. shall be checked in accordance with the methods set out in Annex 3 to this Regulation, except paragraphs 2., 5. and 6. of Annex 3.
- A dummy corresponding to the specifications for Hybrid III fiftieth percentile (see footnote 1 of Annex 3) fitted with a 45° ankle angle and meeting the specifications for its adjustment shall be installed in driver's seat.
- A dummy corresponding to the specifications for Hybrid III fifth percentile (see footnote 1 of Annex 3) fitted with a 45° ankle angle and meeting the specifications for its adjustment shall be installed in the outboard passenger's seat.
- 5.2.1. The performance criteria described in Annex 4 and recorded in accordance with Annex 8, on the dummies in the front outboard seats shall meet the following conditions:
- 5.2.1.1. Hybrid III fiftieth percentile adult male performance requirements:
- 5.2.1.1.1. The Head Performance Criterion (HPC) shall not exceed 1,000 and the resultant head acceleration shall not exceed 80 g for more than 3 ms. The latter shall be calculated cumulatively, excluding rebound movement of the head;
- 5.2.1.1.2. The injury criteria for neck shall not exceed the following values:
- (a) The axial tensile neck force shall not exceed 3.3 kN;
- (b) The fore/aft shear forces at the head/neck interface shall not exceed 3.1 kN;
- (c) The neck bending moment about the y axis shall not exceed 57 Nm in extension;
- 5.2.1.1.3. The Thorax Compression Criterion (ThCC) shall not exceed 42 mm.
- 5.2.1.1.4. The Viscous Criterion (V \* C) for the thorax shall not exceed 1.0 m/s;
- 5.2.1.1.5. The Femur Force Criterion (FFC) shall not exceed 9.07 kN.
- 5.2.1.2. Hybrid III fifth percentile adult female performance requirements:

- 5.2.1.2.1. The Head Performance Criterion (HPC) shall not exceed 1,000 and the resultant head acceleration shall not exceed 80 g for more than 3 ms. The latter shall be calculated cumulatively, excluding rebound movement of the head;
- 5.2.1.2.2. The injury criteria for neck shall not exceed the following values:
  - (a) The axial tensile neck force shall not exceed 2.9 kN;
  - (b) The fore/aft shear forces at the head/neck interface shall not exceed 2.7 kN;
  - (c) The neck bending moment about the y axis shall not exceed 57 Nm in extension.
- 5.2.1.2.3. The Thorax Compression Criterion (ThCC) shall not exceed 34 mm.<sup>3</sup>
- 5.2.1.2.4. The Viscous Criterion (V \* C) for the thorax shall not exceed 1.0 m/s;
- 5.2.1.2.5. The Femur Force Criterion (FFC) shall not exceed 7 kN.
- 5.2.2. Steering wheel displacement
  - 5.2.2.1. After the test the residual steering wheel displacement, when measured at the centre of the steering wheel hub, shall not exceed 80 mm in the upwards vertical direction and 100 mm in the rearward horizontal direction.
  - 5.2.2.2. Vehicles meeting the steering wheel displacement requirements of either Regulations Nos. 12 or 94 are deemed to comply with paragraph 5.2.2.1. above.
- 5.2.3. During the test no door shall open.
  - 5.2.3.1. In the case of automatically activated door locking systems which are installed optionally and/or which can be de-activated by the driver, this requirement shall be verified by using one of the following 2 test procedures, at the choice of the manufacturer:
    - 5.2.3.1.1. If testing in accordance with Annex 3, paragraph 1.4.3.5.2.1., the manufacturer shall in addition demonstrate to the satisfaction of the Technical Service (e.g. manufacturer's in-house data) that, in the absence of the system or when the system is de-activated, no door will open in case of the impact.
    - 5.2.3.1.2. The test is conducted in accordance with Annex 3, paragraph 1.4.3.5.2.2.
  - 5.2.4. After the impact, the side doors shall be unlocked.
    - 5.2.4.1. In the case of vehicles equipped with an automatically activated door locking system, the doors shall be locked before the moment of impact and be unlocked after the impact.
    - 5.2.4.2. In the case of vehicles equipped with automatically activated door locking systems which are installed optionally and/or which can be de-activated by the driver, this requirement shall be verified by using one of the following 2 test procedures, at the choice of the manufacturer:

---

<sup>3</sup> This threshold limit is derived from the injury criteria of a 65-year old fifth percentile female. This criterion should be limited to the front outboard passenger position under the load case and the test condition of this Regulation. Its usage should only be extended following further consideration and review.

- 5.2.4.2.1. If testing in accordance with Annex 3, paragraph 1.4.3.5.2.1., the manufacturer shall in addition demonstrate to the satisfaction of the Technical Service (e.g. manufacturer's in-house data) that, in the absence of the system or when the system is de-activated, no locking of the side doors shall occur during the impact.
- 5.2.4.2.2. The test is conducted in accordance with Annex 3, paragraph 1.4.3.5.2.2.
- 5.2.5. After the impact, it shall be possible, without the use of tools except for those necessary to support the weight of the dummy:
- 5.2.5.1. To open at least one door, if there is one, per row of seats and, where there is no such door, to move the seats or tilt their backrests as necessary to allow the evacuation of all the occupants; this is, however, only applicable to vehicles having a roof of rigid construction;
- 5.2.5.2. To release the dummies from their restraint system which, locked, shall be capable of being released by a maximum force of 60 N on the centre of the release control;
- 5.2.5.3. To remove the dummies from the vehicle without adjustment of the seats.
- 5.2.6. In the case of a vehicle propelled by liquid fuel, no more than slight leakage of liquid from the fuel feed installation shall occur on collision.
- 5.2.7. If there is continuous leakage of liquid from the fuel-feed installation after the collision, the rate of leakage shall not exceed 30 g/min; if the liquid from the fuel-feed system mixes with liquids from the other systems and the various liquids cannot easily be separated and identified, all the liquids collected shall be taken into account in evaluating the continuous leakage.
- 5.2.8. Following the test conducted in accordance with the procedure defined in Annex 9 to this Regulation, the electrical power train operating on high voltage, and the high voltage components and systems, which are galvanically connected to the high voltage bus of the electric power train, shall meet the following requirements:
- 5.2.8.1. Protection against electrical shock
- After the impact at least one of the four criteria specified in paragraph 5.2.8.1.1. through paragraph 5.2.8.1.4.2. below shall be met.
- If the vehicle has an automatic disconnect function, or device(s) that galvanically divide the electric power train circuit during driving condition, at least one of the following criteria shall apply to the disconnected circuit or to each divided circuit individually after the disconnect function is activated.
- However criteria defined in 5.2.8.1.4. below shall not apply if more than a single potential of a part of the high voltage bus is not protected under the conditions of protection degree IPXXB.
- If the test is performed under the condition that part(s) of the high voltage system are not energized, the protection against electrical shock shall be proved by either paragraph 5.2.8.1.3. or paragraph 5.2.8.1.4. below for the relevant part(s).
- For a coupling system that charges the REESS, which is not energized during driving conditions, at least one of the four criteria specified in paragraphs 5.2.8.1.1. to 5.2.8.1.4. shall be met.

5.2.8.1.1. Absence of high voltage

The voltages  $V_b$ ,  $V_1$  and  $V_2$  of the high voltage buses shall be equal or less than 30 VAC or 60 VDC as specified in paragraph 2. of Annex 9.

5.2.8.1.2. Low electrical energy

The Total Energy (TE) on the high voltage buses shall be less than 2.0 joules when measured according to the test procedure as specified in paragraph 3. of Annex 9 with the formula (a). Alternatively the total energy (TE) may be calculated by the measured voltage  $V_b$  of the high voltage bus and the capacitance of the X-capacitors ( $C_x$ ) specified by the manufacturer according to formula (b) of paragraph 3. of Annex 9.

The energy stored in the Y-capacitors ( $TE_{y1}$ ,  $TE_{y2}$ ) shall also be less than 2.0 joules. This shall be calculated by measuring the voltages  $V_1$  and  $V_2$  of the high voltage buses and the electrical chassis, and the capacitance of the Y-capacitors specified by the manufacturer according to formula (c) of paragraph 3. of Annex 9.

5.2.8.1.3. Physical protection

For protection against direct contact with high voltage live parts, the protection IPXXB shall be provided.

In addition, for protection against electrical shock which could arise from indirect contact, the resistance between all exposed conductive parts and the electrical chassis shall be lower than 0.1 Ohm when there is current flow of at least 0.2 Ampere.

This requirement is satisfied if the galvanic connection has been made by welding.

5.2.8.1.4. Isolation resistance

The criteria specified in paragraphs 5.2.8.1.4.1. and 5.2.8.1.4.2. below shall be met.

The measurement shall be conducted in accordance with paragraph 5. of Annex 9.

5.2.8.1.4.1. Electrical power train consisting of separate DC- or AC-buses

If the AC high voltage buses and the DC high voltage buses are galvanically isolated from each other, isolation resistance between the high voltage bus and the electrical chassis ( $R_i$ , as defined in paragraph 5. of Annex 9) shall have a minimum value of 100  $\Omega/V$  of the working voltage for DC buses, and a minimum value of 500  $\Omega/V$  of the working voltage for AC buses.

5.2.8.1.4.2. Electrical power train consisting of combined DC- and AC-buses

If the AC high voltage buses and the DC high voltage buses are galvanically connected isolation resistance between the high voltage bus and the electrical chassis ( $R_i$ , as defined in paragraph 5. of Annex 9) shall have a minimum value of 500  $\Omega/V$  of the working voltage.

However, if the protection IPXXB is satisfied for all AC high voltage buses or the AC voltage is equal or less than 30 V after the vehicle impact, the isolation resistance between the high voltage bus and the electrical chassis ( $R_i$ , as

defined in paragraph 5. of Annex 9) shall have a minimum value of 100  $\Omega/V$  of the working voltage.

5.2.8.2. Electrolyte spillage

In the period from the impact until 30 minutes after no electrolyte from the REESS shall spill into the passenger compartment and no more than 7 per cent of electrolyte shall spill from the REESS except open type traction batteries outside the passenger compartment. For open type traction batteries no more than 7 per cent with a maximum of 5.0 litres shall spill outside the passenger compartment.

The manufacturer shall demonstrate compliance in accordance with paragraph 6. of Annex 9.

5.2.8.3. REESS retention

REESS located inside the passenger compartment shall remain in the location in which they are installed and REESS components shall remain inside REESS boundaries.

No part of any REESS that is located outside the passenger compartment for electric safety assessment shall enter the passenger compartment during or after the impact test.

The manufacturer shall demonstrate compliance in accordance with paragraph 7. of Annex 9.

## **6. Instructions for users of vehicles equipped with airbags**

6.1. The vehicle shall carry information to the effect that it is equipped with airbags for seats.

6.1.1. For a vehicle fitted with an airbag assembly intended to protect the driver, this information shall consist of the inscription "AIRBAG" located in the interior of the circumference of the steering wheel; this inscription shall be durably affixed and easily visible.

6.1.2. For a vehicle fitted with a passenger airbag intended to protect occupants other than the driver, this information shall consist of the warning label described in paragraph 6.2. below.

6.2. A vehicle fitted with one or more passenger frontal protection airbags shall carry information about the extreme hazard associated with the use of rearward-facing child restraints on seats equipped with airbag assemblies.

6.2.1. As a minimum, this information shall consist of a label containing clear warning pictograms as indicated below:

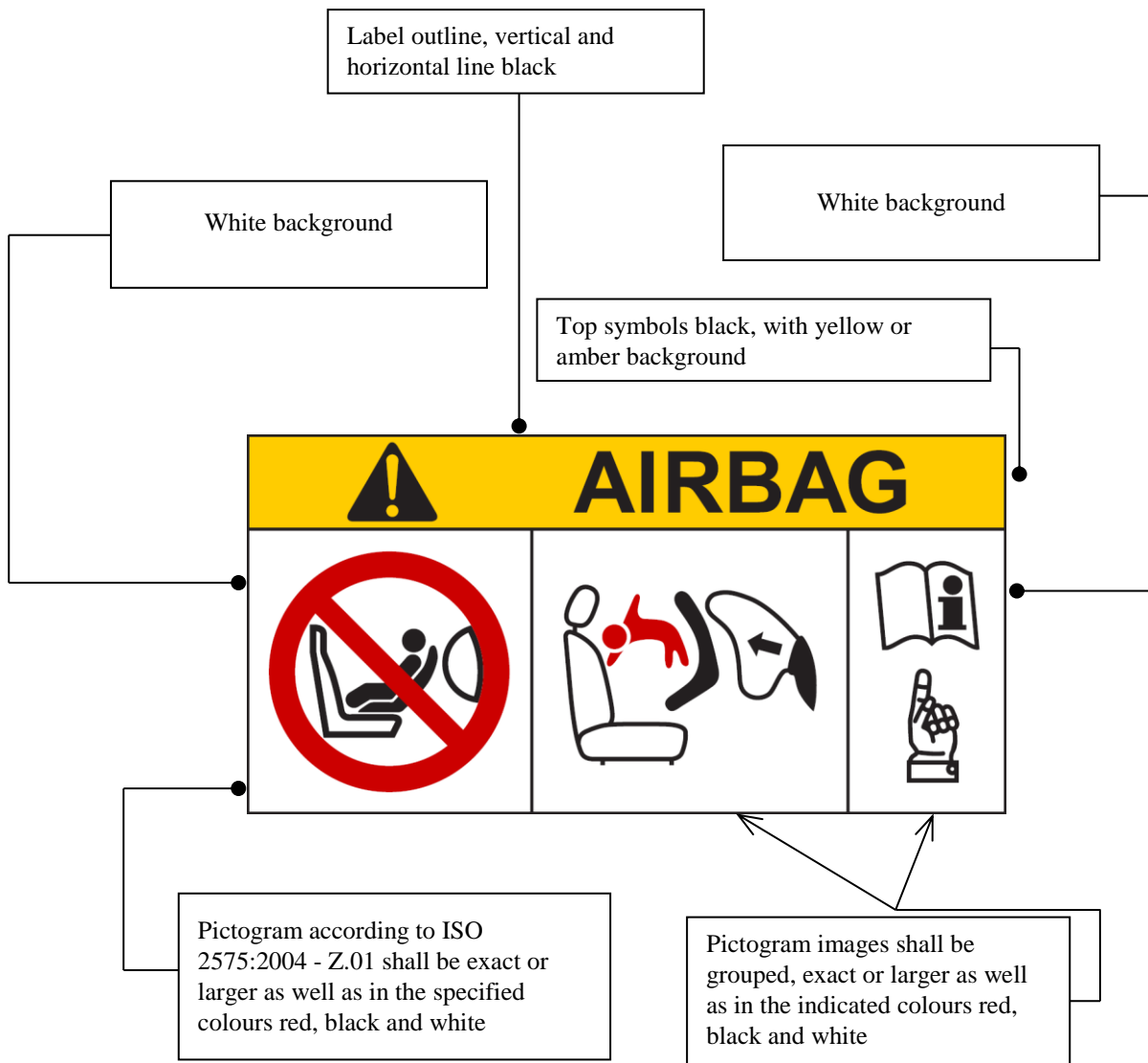

The overall dimensions shall be at least 120 x 60 mm or the equivalent area.

The label shown above may be adapted in such a way that the layout differs from the above example; however, the content shall meet the above prescriptions.

- 6.2.2. In the case of a frontal protection airbag on the front passenger seat, the warning shall be durably affixed to each face of the passenger front sun visor in such a position that at least one warning on the sun visor is visible at all times, irrespective of the position of the sun visor. Alternatively, one warning shall be located on the visible face of the stowed sun visor and a second warning shall be located on the roof behind the visor, so at least one warning is visible all times. It shall not be possible to easily remove the warning label from the visor and the roof without any obvious and clearly visible damage remaining to the visor or the roof in the interior of the vehicle.

In the case of a frontal protection airbag for other seats in the vehicle, the warning shall be directly ahead of the relevant seat, and clearly visible at all times to someone installing a rear-facing child restraint on that seat. The requirements of this paragraph and paragraph 6.2.1. do not apply to those seating positions equipped with a device which automatically deactivates the frontal protection airbag assembly when any rearward facing child restraint is installed.

- 6.2.3. Detailed information, making reference to the warning, shall be contained in the owner's manual of the vehicle; as a minimum, the following text in all official languages of the country or countries where the vehicle could reasonably be expected to be registered (e.g. within the territory of the European Union, in Japan, in Russian Federation or in New Zealand, etc.), shall at least include:

"NEVER use a rearward facing child restraint on a seat protected by an ACTIVE AIRBAG in front of it, DEATH or SERIOUS INJURY to the CHILD can occur"

The text shall be accompanied by an illustration of the warning label as-found in the vehicle. The information shall be easily found in the owner's manual (e.g. specific reference to the information printed on the first page, identifying page tab or separate booklet, etc.)

The requirements of this paragraph do not apply to vehicles of which all passenger seating positions are equipped with a device which automatically deactivates the frontal protection airbag assembly when any rearward facing child restraint is installed.

## **7. Modification and extension of approval of the vehicle type**

- 7.1. Any modification affecting the structure, the number of front seats, the interior trim or fittings, or the position of the vehicle controls or of mechanical parts which might affect the energy-absorption capability of the front of the vehicle shall be brought to the notice of the Type Approval Authority granting approval. The Type Approval Authority may then either:
- 7.1.1. Consider that the modifications made are unlikely to have an appreciable adverse effect and that in any case the vehicle still complies with the requirements; or
- 7.1.2. Require the Technical Service responsible for conducting the tests to carry out a further test, among those described below, according to the nature of the modifications. As this regulation is primarily intended to assess the vehicle restraint system further simplified testing may be conducted using alternative test procedures such as those described in Annex 7.
- 7.1.2.1. Any modification of the vehicle affecting the general form of the structure of the vehicle and/or any increase in mass greater than 8 per cent which in the judgement of the Authority would have a marked influence on the results of the tests shall require a repetition of the test as described in Annex 3;
- 7.1.2.2. If the modifications concern only the interior fittings, if the mass does not increase by more than 8 per cent and if the number of front seats initially provided in the vehicle remains the same, the following shall be carried out:



- 7.1.2.2.1. A simplified test as provided for in Annex 7; and/or
- 7.1.2.2.2. A partial test as defined by the Technical Service in relation to the modifications made.
- 7.2. Confirmation or refusal of approval, specifying the alterations, shall be communicated by the procedure specified in paragraph 4.3. above to the Parties to the Agreement which apply this Regulation.
- 7.3. The Type Approval Authority issuing the extension of approval shall assign a series number for such an extension and inform thereof the other Parties to the 1958 Agreement applying this Regulation by means of a communication form conforming to the model in Annex 1 to this Regulation.

## **8. Conformity of production**

The conformity of production procedures shall comply with those set out in the Agreement, Appendix 2 (E/ECE/324-E/ECE/TRANS/505/Rev.2) with the following requirements:

- 8.1. Every vehicle approved under this Regulation shall conform to the vehicle type approved, as regards features contributing to the protection of the occupants of the vehicle in the event of a frontal collision.
- 8.2. The holder of the approval shall ensure that for each type of vehicle at least the tests concerning the taking of measurements are carried out.
- 8.3. The Type Approval Authority which has granted type approval may at any time verify the conformity control methods applied in each production facility. The normal frequency of these verifications shall be once every two years.

## **9. Penalties for non-conformity of production**

- 9.1. The approval granted in respect of a vehicle type pursuant to this Regulation may be withdrawn if the requirement laid down in paragraph 7.1. above is not complied with or if the vehicle or vehicles selected have failed to pass the checks prescribed in paragraph 7.2. above.
- 9.2. If a Contracting Party to the Agreement applying this Regulation withdraws an approval it has previously granted, it shall forthwith so notify the other Contracting Parties applying this Regulation, by means of a communication form conforming to the model in Annex 1 to this Regulation.

## **10. Production definitively discontinued**

If the holder of the approval completely ceases to manufacture the type of vehicle approved in accordance with the Regulation, they shall so inform the Type Approval Authority which granted the approval. Upon receiving the relevant communication that Authority shall inform thereof the other Parties to the 1958 Agreement applying this Regulation by means of a communication form conforming to the model in Annex 1 to this Regulation.

## **11. Transitional provisions**

- 11.1. As from the official date of entry into force of the 01 series of amendments to this Regulation, no Contracting Party applying this Regulation shall refuse to grant or refuse to accept type approvals to this Regulation as amended by the 01 series of amendments.
- 11.2. Even after the date of entry into force of the 01 series of amendments, Contracting Parties applying this Regulation may continue granting type approvals, and shall not refuse to grant extensions of type approvals, to this Regulation in its original form.
- 11.3. As from 1 September 2020, Contracting Parties applying this Regulation shall not be obliged to accept type approvals to this Regulation in its original form, first issued as from 1 September 2020.
- 11.4. After 1 September 2020, Contracting Parties applying this Regulation shall continue to accept approvals of vehicle types to this Regulation in its original form, which were granted before 1 September 2020.

## **12. Names and addresses of Technical Services responsible for conducting approval tests, and of Type Approval Authorities**

The Contracting Parties to the Agreement applying this Regulation shall communicate to the United Nations secretariat the names and addresses of the Technical Services responsible for conducting approval tests, of manufacturers authorized to carry out tests and of the Type Approval Authorities which grant approval and to which forms certifying approval or refusal or withdrawal of approval, issued in other countries, are to be sent.

## Annex 1

### Communication

(Maximum format: A4 (210 x 297 mm))



Issued by:

Name of administration:

.....  
.....  
.....  
.....

Concerning:<sup>2</sup> Approval granted,  
Approval extended,  
Approval refused,  
Approval withdrawn,  
Production definitively discontinued,

of a vehicle type with regard to the protection of the occupants in the event of a frontal collision, pursuant to Regulation No. 137

Approval No.: ..... Extension No.:.....

1. Trade name or mark of the power-driven vehicle .....
2. Vehicle type .....
3. Manufacturer's name and address .....
4. If applicable, name and address of manufacturer's representative .....
5. Brief description of the vehicle type as regards its structure, dimensions, lines and constituent materials .....
- 5.1. Description of the protective system installed in the vehicle .....
- 5.2. Description of interior arrangements or fittings that might affect the tests .....
- 5.3. Location of the electrical power source .....

<sup>1</sup> Distinguishing number of the country which has granted/extended/refused/withdrawn approval (see approval provisions in the Regulation).

<sup>2</sup> Strike out what does not apply.

6. Site of engine: forward/rear/central<sup>2</sup>
  7. Drive: front-wheel/rear-wheel<sup>2</sup>
  8. Mass of vehicle submitted for testing:  
Front axle: .....  
Rear axle: .....  
Total:.....
  9. Vehicle submitted for approval on .....
  10. Technical Service responsible for conducting approval tests .....
  11. Date of report issued by that Service .....
  12. Number of report issued by that Service .....
  13. Approval granted/refused/extended/withdrawn<sup>2</sup>
  14. Position of approval mark on vehicle .....
  15. Place .....
  16. Date .....
  17. Signature .....
  18. The following documents, bearing the approval number shown above,  
are annexed to this communication .....
- (Photographs and/or diagrams and drawings permitting the basic identification of the type(s) of vehicle and its possible variants which are covered by the approval)

## Annex 2

### Arrangements of approval marks

Model A

(See paragraph 4.4. of this Regulation.)

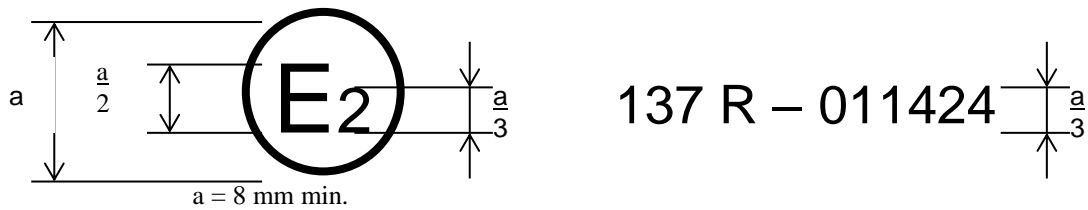

The above approval mark affixed to a vehicle shows that the vehicle type concerned has, with regard to the protection of the occupants in the event of a frontal collision, been approved in France (E 2) pursuant to Regulation No. 137 under approval number 011424. The approval number indicates that the approval was granted in accordance with the requirements of Regulation No. 137 01 series of amendments.

Model B

(See paragraph 4.5. of this Regulation.)

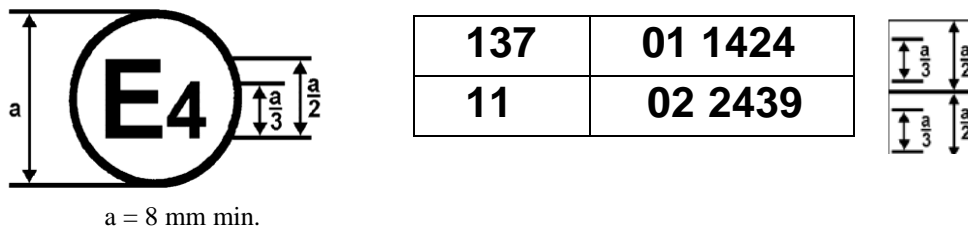

The above approval mark affixed to a vehicle shows that the vehicle type concerned has been approved in the Netherlands (E 4) pursuant to Regulations Nos. 137 and 11.<sup>1</sup> The first two digits of the approval numbers indicate that, at the dates when the respective approvals were granted, Regulation No. 137 incorporated the 01 series of amendments and Regulation No. 11 incorporated the 02 series of amendments.

<sup>1</sup> The latter number is given only as an example.

## Annex 3

### Test procedure

The purpose of this test is to verify whether the vehicle satisfies the requirements set forth in paragraph 5.2. of the Regulation.

1. Installation and preparation of the vehicle

1.1. Testing ground

The test area shall be large enough to accommodate the run-up track, barrier and technical installations necessary for the test. The last part of the track, for at least 5 m before the barrier, shall be horizontal, flat and smooth.

1.2. Barrier

The barrier shall consist of a block of reinforced concrete not less than 3 m wide in front and not less than 1.5 m high. The barrier shall be of such thickness that it weighs at least 70 metric tons. The front face shall be flat, vertical and perpendicular to the axis of the run-up track. It shall be covered with plywood boards  $20 \pm 2$  mm thick, in good condition. A structure on a steel plate at least 25 mm thick may be placed between the plywood board and the barrier. A barrier with different characteristics may likewise be used, provided that the area of the impact surface is greater than the frontal crash area of the vehicle being tested and provided that it gives equivalent results.

1.3. Orientation of the barrier

1.3.1. Alignment of the vehicle to the barrier.

It shall reach the obstacle on a course perpendicular to the collision wall; the maximum lateral misalignment tolerated between the vertical median line of the front of the vehicle and the vertical median line of the collision wall is  $\pm 30$  cm.

1.4. State of vehicle

1.4.1. General specification

The test vehicle shall be representative of the series production, shall include all the equipment normally fitted and shall be in normal running order. Some components may be replaced by equivalent masses where this substitution clearly has no noticeable effect on the results measured under paragraph 6. below.

It shall be allowed by agreement between manufacturer and Technical Service to modify the fuel system so that an appropriate amount of fuel can be used to run the engine or the electrical energy conversion system.

1.4.2. Mass of vehicle

1.4.2.1. For the test, the mass of the vehicle submitted shall be the unladen kerb mass;

1.4.2.2. The fuel tank shall be filled with water to mass equal to 90 per cent of the mass of a full load of fuel as specified by the manufacturer with a tolerance of  $\pm 1$  per cent;

This requirement does not apply to hydrogen fuel tanks.

- 1.4.2.3. All the other systems (brake, cooling ...) may be empty in this case, the mass of the liquids shall be compensated;
- 1.4.2.4. If the mass of the measuring apparatus on board the vehicle exceeds the 25 kg allowed; it may be compensated by reductions which have no noticeable effect on the results measured under paragraph 6 below.
- 1.4.2.5. The mass of the measuring apparatus shall not change each axle reference load by more than 5 per cent, each variation not exceeding 20 kg.
- 1.4.2.6. The mass of the vehicle resulting from the provisions of paragraph 1.4.2.1. above shall be indicated in the report.
- 1.4.3. Passenger compartment adjustments
  - 1.4.3.1. Position of steering wheel

The steering wheel, if adjustable, shall be placed in the normal position indicated by the manufacturer or, in the absence of any particular recommendation by the manufacturer, midway between the limits of its range(s) of adjustment. At the end of the propelled travel, the steering wheel shall be left free, with its spokes in the position which according to the manufacturer corresponds to straight-ahead travel of the vehicle.
  - 1.4.3.2. Glazing

The movable glazing of the vehicle shall be in the closed position. For test measurement purposes and in agreement with the manufacturer, it may be lowered, provided that the position of the operating handle corresponds to the closed position.
  - 1.4.3.3. Gear-change lever position

The gear-change lever shall be in the neutral position. If the vehicle is propelled by its own engine, then the gear-change lever position shall be defined by the manufacturer.
  - 1.4.3.4. Pedals

The pedals shall be in their normal position of rest. If adjustable, they shall be set in their mid-position unless another position is specified by the manufacturer.
  - 1.4.3.5. Doors

The doors shall be closed but not locked.

    - 1.4.3.5.1. In the case of vehicles equipped with an automatically activated door locking system, the system shall be activated at the start of propulsion of the vehicle in order to lock the doors automatically before the moment of impact. At the choice of the manufacturer, the doors shall be locked manually before the start of propulsion of the vehicle.
    - 1.4.3.5.2. In the case of vehicles equipped with an automatically activated door locking system that is installed optionally and/or which can be de-activated by the driver, one of the following two procedures shall be used at the choice of the manufacturer:

- 1.4.3.5.2.1. The system shall be activated at the start of propulsion of the vehicle in order to lock the doors automatically before the moment of impact. At the choice of the manufacturer, the doors shall be locked manually before the start of propulsion of the vehicle.
- 1.4.3.5.2.2. The side doors on the driver side shall be unlocked and the system overridden for these doors; for the side doors on the passenger side, the system may be activated in order to lock these doors automatically before the moment of impact. At the choice of the manufacturer, these doors shall be locked manually before the start of propulsion of the vehicle. This test is deemed to be fulfilled, if the unlocked and locked doors are reversed.
- 1.4.3.6. Opening roof  
If an opening or removable roof is fitted, it shall be in place and in the closed position. For test measurement purposes and in agreement with the manufacturer, it may be open.
- 1.4.3.7. Sun-visor  
The sun-visors shall be in the stowed position.
- 1.4.3.8. Rear-view mirror  
The interior rear-view mirror shall be in the normal position of use.
- 1.4.3.9. Arm-rests  
Arm-rests at the front and rear, if movable, shall be in the lowered position, unless this is prevented by the position of the dummies in the vehicles.
- 1.4.3.10. Head restraints  
Head restraints adjustable for height shall be in their appropriate position as defined by the manufacturer. In the absence of any particular recommendation from the manufacturer, then the head restraints shall be in their uppermost position for the fiftieth percentile male and in the lowermost position for the fifth percentile female dummy.
- 1.4.3.11. Seats
- 1.4.3.11.1. Position of front driver seat  
Seats adjustable longitudinally shall be placed so that their "H" point, determined in accordance with the procedure set out in Annex 6 is in the middle position of travel or in the nearest locking position thereto, and at the height position defined by the manufacturer (if independently adjustable for height). In the case of a bench seat, the reference shall be to the "H" point of the driver's place.
- 1.4.3.11.2. Position of front passenger seat  
Seats adjustable longitudinally shall be placed so that their "H" point, determined in accordance with the procedure set out in Annex 6, is:
- (a) In the position given by the manufacturer, which shall be forward of the middle position of travel; or
  - (b) In the absence of any particular recommendation from the manufacturer, as near as possible to a position which is midway between the forward most position of the seat and the centre position of its travel.



Any support system shall be adjusted as defined by the manufacturer. In the absence of any particular recommendation from the manufacturer, then any support system (e.g. seat cushion length and tilt adjustment) shall be in its retracted/ lowermost position.

1.4.3.11.3. Position of the front seat-backs

If adjustable, the seat-backs shall be adjusted so that the resulting inclination of the torso of the dummy is as close as possible to that recommended by the manufacturer for normal use or, in the absence of any particular recommendation by the manufacturer, to 25° towards the rear from the vertical. For the fifth percentile female dummy, the seat back may be adjusted to a different angle, if this is needed to respect the requirements of Annex 5, paragraph 3.1.

1.4.3.11.4. Rear seats

If adjustable, the rear seats or rear bench seats shall be placed in the rearmost position.

1.4.4. Electrical power train adjustment

1.4.4.1. The REESS shall be at any state of charge, which allows the normal operation of the power train as recommended by the manufacturer.

1.4.4.2. The electrical power train shall be energized with or without the operation of the original electrical energy sources (e.g. engine-generator, REESS or electric energy conversion system), however:

1.4.4.2.1. By the agreement between Technical Service and manufacturer it shall be permissible to perform the test with all or parts of the electrical power train not being energized insofar as there is no negative influence on the test result. For parts of the electrical power train not energized, the protection against electrical shock shall be proved by either physical protection or isolation resistance and appropriate additional evidence.

1.4.4.2.2. In the case where an automatic disconnect is provided, at the request of the manufacturer it shall be permissible to perform the test with the automatic disconnect being triggered. In this case it shall be demonstrated that the automatic disconnect would have operated during the impact test. This includes the automatic activation signal as well as the galvanic separation considering the conditions as seen during the impact.

2. Dummies

2.1. Front seats

2.1.1. A dummy corresponding to the specifications for Hybrid III fiftieth percentile male dummy<sup>1</sup> meeting the specifications for its adjustment shall be installed in the driver seat in accordance with the conditions set out in Annex 5.

---

<sup>1</sup> The Working Party on Passive Safety (GRSP) of UNECE intends to prepare an addendum for the Mutual Resolution M.R.1 on frontal impact dummies. Until the addendum is available the technical specifications and detailed drawings of Hybrid III with the principal dimensions of a fiftieth percentile male and of a fifth percentile female dummy and the specifications for their adjustment for this test are deposited with the Secretary-General of the United Nations and may be consulted on request at the secretariat to the Economic Commission for Europe, Palais des Nations, Geneva, Switzerland.

- A dummy corresponding to the specifications for Hybrid III fifth percentile female dummy<sup>1</sup> meeting the specifications for its adjustment shall be installed in the passenger seat in accordance with the conditions set out in Annex 5.
- 2.1.2. The car will be tested with restraint systems, as provided by the manufacturer.
3. Propulsion and course of vehicle
- 3.1. The vehicle shall be propelled by its own engine or by any other propelling device;
- 3.2. At the moment of impact the vehicle shall no longer be subject to the action of any additional steering or propelling device.
- 3.3. The course of the vehicle shall be such that it satisfies the requirements of paragraphs 1.2. and 1.3.1.
4. Test speed
- Vehicle speed at the moment of impact shall be 50 -0/ +1 km/h. However, if the test was performed at a higher impact speed and the vehicle met the requirements, the test shall be considered satisfactory.
5. Measurements to be made on dummies in front seats
- 5.1. All the measurements necessary for the verification of the performance criteria shall be made with measurement systems corresponding to the specifications of Annex 8.
- 5.2. The different parameters shall be recorded through independent data channels of the following CFC (Channel Frequency Class):
- 5.2.1. Measurements in the head of the dummy
- The acceleration (a) referring to the centre of gravity is calculated from the triaxial components of the acceleration measured with a CFC of 1,000.
- 5.2.2. Measurements in the neck of the dummy
- 5.2.2.1. The axial tensile force and the fore/aft shear force at the neck/head interface are measured with a CFC of 1,000.
- 5.2.2.2. The bending moment about a lateral axis at the neck/head interface are measured with a CFC of 600.
- 5.2.3. Measurements in the thorax of the dummy
- The chest deflection between the sternum and the spine is measured with a CFC of 180.
- 5.2.4. Measurements in the femur of the dummy
- 5.2.4.1. The axial compressive force and the bending moments are measured with a CFC of 600.
6. Measurements to be made on the vehicle
- 6.1. To enable the simplified test described in Annex 7 to be carried out, the deceleration time history of the structure shall be determined on the basis of the value of the longitudinal accelerometers at the base of one of the "B" pillars of the vehicle with a CFC of 180 by means of data channels corresponding to the requirements set out in Annex 8;
- 6.2. The speed time history which will be used in the test procedure described in Annex 7 shall be obtained from the longitudinal accelerometer at the "B" pillar.

7. Equivalent procedures
- 7.1. Alternative procedures may be permitted at the discretion of the Type Approval Authority provided equivalence can be demonstrated. A report shall be attached to the approval documentation describing the method used and the results obtained or the reason for not carrying out the test.
- 7.2. Responsibility for demonstrating the equivalence of the alternative method shall rest with the manufacturer or his agent wishing to use such a method.

## Annex 4

### Performance criteria

1. Head Performance Criterion (HPC<sub>36</sub>)
  - 1.1. The Head Performance Criterion (HPC<sub>36</sub>) is considered to be satisfied when, during the test, there is no contact between the head and any vehicle component.
  - 1.2. If, during the test, there is contact between the head and any vehicle component, a calculation of HPC is made, on the basis of the acceleration (a), measured according to paragraph 5.2.1. of Annex 3, by the following expression:
$$\text{HPC} = (t_2 - t_1) \left[ \frac{1}{t_2 - t_1} \int_{t_1}^{t_2} a dt \right]^{2.5}$$
in which:
    - 1.2.1. The term "a" is the resultant acceleration measured according to paragraph 5.2.1. of Annex 3 and is measured in units of gravity, g (1 g = 9,81 m/s<sup>2</sup>);
    - 1.2.2. If the beginning of the head contact can be determined satisfactorily, t<sub>1</sub> and t<sub>2</sub> are the two time instants, expressed in seconds, defining an interval between the beginning of the head contact and the end of the recording for which the value of HPC is maximum;
    - 1.2.3. If the beginning of the head contact cannot be determined, t<sub>1</sub> and t<sub>2</sub> are the two time instants, expressed in seconds, defining a time interval between the beginning and the end of the recording for which the value of HPC is maximum;
    - 1.2.4. Values of HPC for which the time interval (t<sub>1</sub> - t<sub>2</sub>) is greater than 36 ms are ignored for the purposes of calculating the maximum value.
  - 1.3. The value of the resultant head acceleration during forward impact which is exceeded for 3 ms cumulatively is calculated from the resultant head acceleration measured according to paragraph 5.2.1. of Annex 3.
2. Injury criteria for neck
  - 2.1. These criteria are determined by, the axial tensile force and the fore/aft shear forces at the head/neck interface, expressed in kN and measured according to paragraph 5.2.2. of Annex 3.
  - 2.2. The neck bending moment criterion is determined by the bending moment, expressed in Nm, about a lateral axis at the head/neck interface and measured according to paragraph 5.2.2. of Annex 3.
3. Thorax Compression Criterion (THCC) and Viscous Criterion (V \* C)
  - 3.1. The thorax compression criterion is determined by the absolute value of the thorax deformation, expressed in mm and measured according to paragraph 5.2.3. of Annex 3.

- 3.2. The Viscous Criterion ( $V * C$ ) is calculated as the instantaneous product of the compression and the rate of deflection of the sternum, measured according to paragraph 6. of this annex and also paragraph 5.2.3. of Annex 3.
4. Femur Force Criterion (FFC)
- 4.1. This criterion is determined by the compression load expressed in kN, transmitted axially on each femur of the dummy and measured according to paragraph 5.2.4. of Annex 3.
5. Procedure for calculating the viscous criteria ( $V * C$ ) for Hybrid III dummy
- 5.1. The viscous criterion is calculated as the instantaneous product of the compression and the rate of deflection of the sternum. Both are derived from the measurement of sternum deflection.
- 5.2. The sternum deflection response is filtered once at CFC 180. The compression at time  $t$  is calculated from this filtered signal as:

$$C(t) = D(t) / \text{constant},$$

where constant percentile male = 0.229 for the HIII 50<sup>th</sup>

and constant percentile female = 0.187 for the HIII 5<sup>th</sup>

The sternum deflection velocity at time  $t$  is calculated from the filtered deflection as:

$$V_{(t)} = \frac{8(D_{(t+1)} - D_{(t-1)}) - (D_{(t+2)} - D_{(t-2)})}{12\delta t}$$

Where  $D_{(t)}$  is the deflection at time  $t$  in metres and  $\delta t$  is the time interval in seconds between the measurements of deflection. The maximum value of  $\delta t$  shall be  $1.25 \times 10^{-4}$  seconds. This calculation procedure is shown diagrammatically below:

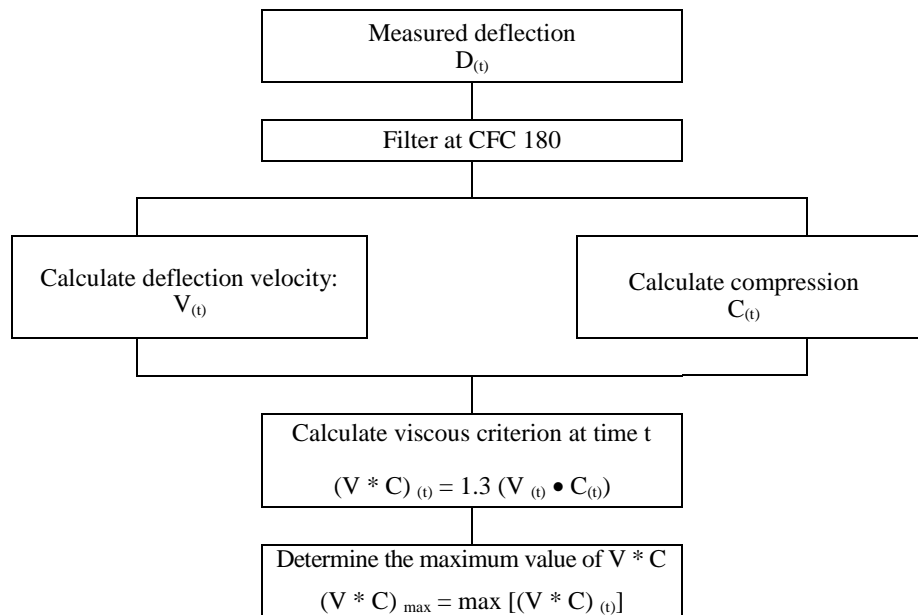

## Annex 5

### Arrangement and installation of dummies and adjustment of restraint systems

1. Arrangement of dummies
  - 1.1. Separate seats

The plane of symmetry of the dummy shall coincide with the vertical median plane of the seat.
  - 1.2. Front bench seat
    - 1.2.1. Driver

The plane of symmetry of the dummy shall lie in the vertical plane passing through the steering wheel centre and parallel to the longitudinal median plane of the vehicle. If the seating position is determined by the shape of the bench, such seat shall be regarded as a separate seat.
    - 1.2.2. Outer passenger

The plane of symmetry of the dummy shall be symmetrical with that of the driver dummy relative to the longitudinal median plane of the vehicle. If the seating position is determined by the shape of the bench, such seat shall be regarded as a separate seat.
  - 1.3. Bench seat for front passengers (not including driver)

The planes of symmetry of the dummy shall coincide with the median planes of the seating positions defined by the manufacturer.
2. Installation of the HIII fiftieth percentile male dummy on the driver seat
  - 2.1. Head

The transverse instrumentation platform of the head shall be horizontal within 2.5°. To level the head of the test dummy in vehicles with upright seats with non-adjustable backs, the following sequences shall be followed. First adjust the position of the "H" point within the limits set forth in paragraph 2.4.3.1. below to level the transverse instrumentation platform of the head of the test dummy. If the transverse instrumentation platform of the head is still not level, then adjust the pelvic angle of the test dummy within the limits provided in paragraph 2.4.3.2. below. If the transverse instrumentation platform of the head is still not level, then adjust the neck bracket of the test dummy the minimum amount necessary to ensure that the transverse instrumentation platform of the head is horizontal within 2.5°.
  - 2.2. Arms
    - 2.2.1. The driver's upper arms shall be adjacent to the torso with the centrelines as close to a vertical plane as possible.

- 2.3. Hands
- 2.3.1. The palms of the driver test dummy shall be in contact with the outer part of the steering wheel rim at the rim's horizontal centreline. The thumbs shall be over the steering wheel rim and shall be lightly taped to the steering wheel rim so that if the hand of the test dummy is pushed upward by a force of not less than 9 N and not more than 22 N, the tape shall release the hand from the steering wheel rim.
- 2.4. Torso
- 2.4.1. In vehicles equipped with bench seats, the upper torso of the driver test dummy shall rest against the seat back. The midsagittal plane of the driver dummy shall be vertical and parallel to the vehicle's longitudinal centreline, and pass through the centre of the steering wheel rim.
- 2.4.2. In vehicles equipped with individual seats, the upper torso of the driver test dummy shall rest against the seat back. The midsagittal plane of the driver dummy shall be vertical and shall coincide with the longitudinal centreline of the individual seat.
- 2.4.3. Lower torso
- 2.4.3.1. "H" point
- The "H" point of the driver test dummy shall coincide within 13 mm in the vertical dimension and 13 mm in the horizontal dimension, with a point 6 mm below the position of the "H" point determined using the procedure described in Annex 6 except that the length of the lower leg and thigh segments of the "H" point machine shall be adjusted to 414 and 401 mm, instead of 417 and 432 mm respectively.
- 2.4.3.2. Pelvic angle
- As determined using the pelvic angle gauge (GM) drawing 78051-532 incorporated by reference in Part 572 which is inserted into the "H" point gauging hole of the dummy, the angle measured from the horizontal on the 76.2 mm (3 inch) flat surface of the gauge shall be 22.5 degrees plus or minus 2.5 degrees.
- 2.5. Legs
- The upper legs of the driver test dummy shall rest against the seat cushion to the extent permitted by placement of the feet. The initial distance between the outboard knee clevis flange surfaces shall be 270 mm  $\pm$  10 mm. To the extent practicable, the left leg of the driver dummy shall be in vertical longitudinal planes. To the extent practicable, the right leg of the driver dummy shall be in a vertical plane. Final adjustment to accommodate placement of feet in accordance with paragraph 2.6. for various passenger compartment configurations is permitted.
- 2.6. Feet
- 2.6.1. The right foot of the driver test dummy shall rest on the undepressed accelerator with the rearmost point of the heel on the floor surface in the plane of the pedal. If the foot cannot be placed on the accelerator pedal, it shall be positioned perpendicular to the tibia and placed as far forward as possible in the direction of the centreline of the pedal with the rearmost point of the heel

resting on the floor surface. The heel of the left foot shall be placed as far forward as possible and shall rest on the floor pan. The left foot shall be positioned as flat as possible on the toe board. The longitudinal centreline of the left foot shall be placed as parallel as possible to the longitudinal centreline of the vehicle. For vehicles equipped with a footrest, it shall be possible at the request of the manufacturer to place the left foot on the footrest. In this case the position of the left foot is defined by the footrest.

- 2.7. The measuring instruments installed shall not in any way affect the movement of the dummy during impact.
- 2.8. The temperature of the dummy and the system of measuring instruments shall be stabilized before the test and maintained so far as possible within a range between 19 °C and 22.2 °C.
- 2.9. Dummy HIII fiftieth percentile clothing
  - 2.9.1. The instrumented dummy will be clothed in formfitting cotton stretch garments with short sleeves and mid-calf length trousers specified in FMVSS 208, drawings 78051-292 and 293 or their equivalent.
  - 2.9.2. A size 11XW shoe, which meets the configuration size, sole and heel thickness specifications of the United States of America military standard MIL S 13192, revision P and whose weight is  $0.57 \pm 0.1$  kg, shall be placed and fastened on each foot of the test dummy.
3. Installation of the Hybrid III fifth percentile female dummy on the passenger seat.

The longitudinal and vertical dimension of "H" point are described as ( $X_{50thM}$ ,  $Z_{50thM}$ ) and the longitudinal and vertical dimension of "H 5<sup>th</sup>" point are described as ( $X_{5thF}$ ,  $Z_{5thF}$ ).  $X_{SCL}$  is defined as the horizontal distance between the "H" point and the most forward point on the seat cushion (see Figure 1). Use the following formula to calculate the "H 5<sup>th</sup>" point. Note that  $X_{5thF}$  should always be more forward than the  $X_{50thM}$ .

$$X_{5thF} = X_{50thM} + (93 \text{ mm} - 0.323 \times X_{SCL})$$

$$Z_{5thF} = Z_{50thM}$$



Figure 1

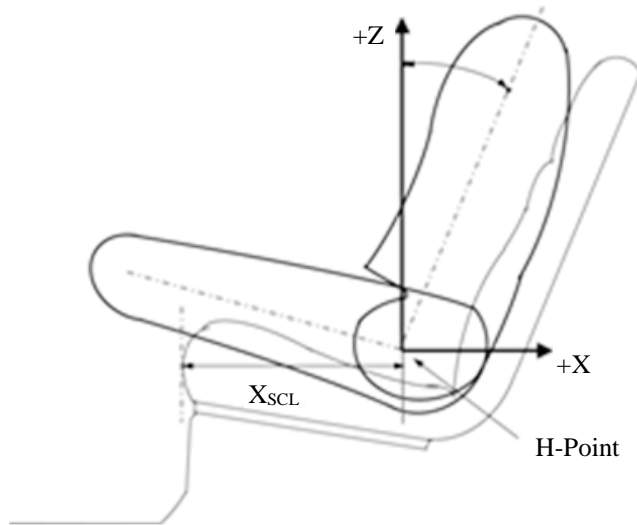

3.1. Head

The transverse instrumentation platform of the head shall be horizontal within 2.5°. To level the head of the test dummy in vehicles with upright seats with non-adjustable backs, the following sequences shall be followed. First adjust the position of the "H 5<sup>th</sup>" point within the limits set forth in paragraph 3.4.3.1. below to level the transverse instrumentation platform of the head of the test dummy. If the transverse instrumentation platform of the head is still not level, then adjust the pelvic angle of the test dummy within the limits provided in paragraph 3.4.3.2. below. If the transverse instrumentation platform of the head is still not level, then adjust the neck bracket of the test dummy the minimum amount necessary to ensure that the transverse instrumentation platform of the head is horizontal within 2.5°.

3.2. Arms

3.2.1. The passenger's upper arms shall be in contact with the seat back and the sides of the torso.

3.3. Hands

3.3.1. The palms of the passenger test dummy shall be in contact with outside of thigh. The little finger shall be in contact with the seat cushion.

3.4. Torso

3.4.1. In vehicles equipped with bench seats, the upper torso of the passenger test dummy shall rest against the seat back. The midsagittal plane of the passenger dummy shall be vertical and parallel to the vehicle's longitudinal centreline and the same distance from the vehicle's longitudinal centreline as the midsagittal plane of the driver dummy.

3.4.2. In vehicles equipped with individual seats, the upper torso of the passenger test dummy shall rest against the seat back. The midsagittal plane of the passenger dummy shall be vertical and shall coincide with the longitudinal centreline of the individual seat.

3.4.3. Lower torso

3.4.3.1. "H 5<sup>th</sup>" point

The "H 5<sup>th</sup>" point of passenger test dummy shall coincide within 13 mm in the horizontal dimension, of the "H 5<sup>th</sup>" point determined using the procedure described in Annex 6 and paragraph 3. above.

3.4.3.2. Pelvic angle

As determined using the pelvic angle gauge (GM) drawing 78051-532 incorporated by reference in Part 572 which is inserted into the "H" point gauging hole of the dummy, the angle measured from the horizontal on the 76.2 mm (3 inch) flat surface of the gauge shall be 20 degrees plus or minus 2.5 degrees.

3.5. Legs

The upper legs of the passenger test dummy shall rest against the seat cushion to the extent permitted by placement of the feet. The initial distance between the outboard knee clevis flange surfaces shall be  $229 \text{ mm} \pm 5 \text{ mm}$  as shown in Figure 2. To the extent practicable, both legs of the passenger dummy shall be in vertical longitudinal planes. Final adjustment to accommodate placement of feet in accordance with paragraph 3.6. for various passenger compartment configurations is permitted.

Figure 2

**The initial knee distance of Hybrid III fifth percentile female**

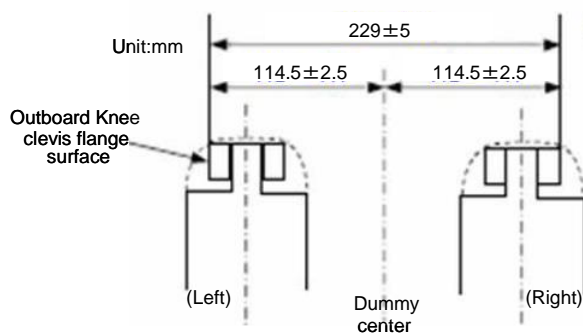

3.6. Feet

3.6.1.

The legs shall be positioned as distant as possible from the front end of the seat cushion while the thighs are kept in contact with the seat cushion as shown in Fig. (a). As shown in Fig. (b), each leg shall be lowered until the foot comes in contact with the floor while the foot and tibia are kept in a right angle to one another and the thigh inclination angle kept constant. When each heel is in contact with the floor, the foot shall be rotated so that the toe comes as much in contact as possible with the floor as shown in Fig. (c).

If it is not possible to have each foot in contact with the floor, the foot shall be lowered until the calf comes in contact with the front end of the seat cushion or the back of the foot comes in contact with the vehicle interior. The foot shall be kept as parallel as possible to the floor as shown in Fig. (d).

In case of interference from a vehicle body protrusion, the foot shall be rotated as minimally as possible around the tibia. In case interference still remains, the femur shall be rotated to resolve or minimize the interference. The foot shall be moved inward or outward while the separation distance between the knees is kept constant.

Figure (a)

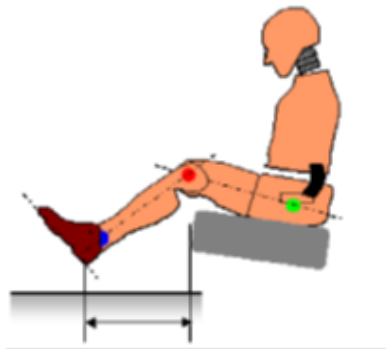

Figure (b)

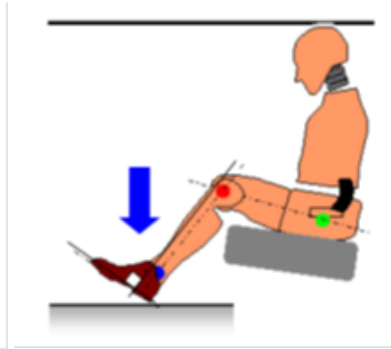

Figure (c)

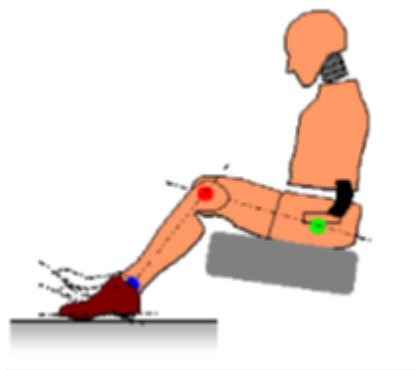
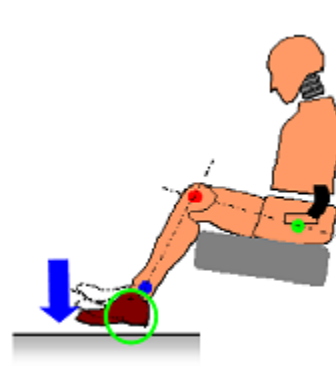

Figure (d)



- 3.7. The measuring instruments installed shall not in any way affect the movement of the dummy during impact.
- 3.8. The temperature of the dummies and the system of measuring instruments shall be stabilized before the test and maintained so far as possible within a range between 19 °C and 22.2 °C.
- 3.9. Dummy HIII fifth percentile clothing
  - 3.9.1. The instrumented dummy will be clothed in formfitting cotton stretch garments with short sleeves and mid-calf length trousers specified in FMVSS 208, drawings 78051-292 and 293 or their equivalent.
  - 3.9.2. A size 7.5 W small female size shoe, which meets the configuration size, sole and heel thickness specifications of the United States of America military standard MIL-S-21711E, revision P and whose weight is  $0.41 \pm 0.09$  kg, shall be placed and fastened on each foot of the test dummies.

4. Adjustment of restraint system

The dummy jacket shall be installed at the appropriate position where the bolt hole of the neck lower bracket and the work hole of the dummy jacket should be at the same position. With the test dummy at its designated seating position as specified by the appropriate requirements of paragraphs 2.1. through 2.6. and paragraphs 3.1. to 3.6. above, place the belt around the test dummy and fasten the latch. Remove all slack from the lap belt. Pull the upper torso webbing out of the retractor and allow it to retract. Repeat this operation four times. The shoulder belt should be at the position between the area which shall not be taken off of shoulder and shall not come in contact with the neck. The seat belt path shall be positioned: for Hybrid III fiftieth percentile male dummy, the hole of the outer side dummy jacket shall not be fully hidden by the seat belt. For Hybrid III fifth percentile female dummy, the seat belt shall lie between the breasts. Apply a 9 to 18 N tension load to the lap belt. If the belt system is equipped with a tension-relieving device, introduce the maximum amount of slack into the upper torso belt that is recommended by the manufacturer for normal use in the owner's manual for the vehicle. If the belt system is not equipped with a tension-relieving device, allow the excess webbing in the shoulder belt to be retracted by the rewind force of the retractor. Where the safety belt and safety belt anchorages are located such that the belt does not lie as required above then the safety belt may be manually adjusted and retained by tape.

## **Annex 6**

### **Procedure for determining the "H" point and the actual torso angle for seating positions in motor vehicles<sup>1</sup>**

#### **Appendix 1 - Description of the three dimensional "H" point machine (3-D H machine)<sup>1</sup>**

#### **Appendix 2 - Three-dimensional reference system<sup>1</sup>**

#### **Appendix 3 - Reference data concerning seating positions<sup>1</sup>**

---

<sup>1</sup> The procedure is described in Annex 1 to the Consolidated Resolution on the Construction of Vehicles (RE.3) (document ECE/TRANS/WP.29/78/Rev.6).  
[www.unece.org/trans/main/wp29/wp29wgs/wp29gen/wp29resolutions.html](http://www.unece.org/trans/main/wp29/wp29wgs/wp29gen/wp29resolutions.html)

## Annex 7

### Test procedure with trolley

1. Test installation and procedure
  - 1.1. Trolley

The trolley shall be so constructed that no permanent deformation appears after the test. It shall be so guided that, during the impact phase, the deviation in the vertical plane does not exceed 5° and 2° in the horizontal plane.
  - 1.2. State of the structure
    - 1.2.1. General

The structure tested shall be representative of the series production of the vehicles concerned. Some components may be replaced or removed where such replacement or removal clearly has no effect on the test results.
    - 1.2.2. Adjustments

Adjustments shall conform to those set out in paragraph 1.4.3. of Annex 3 to this Regulation, taking into account what is stated in paragraph 1.2.1. above.
  - 1.3. Attachment of the structure
    - 1.3.1. The structure shall be firmly attached to the trolley in such a way that no relative displacement occurs during the test.
    - 1.3.2. The method used to fasten the structure to the trolley shall not have the effect of strengthening the seat anchorages or restraint devices, or of producing any abnormal deformation of the structure.
    - 1.3.3. The attachment device recommended is that whereby the structure rests on supports placed approximately in the axis of the wheels or, if possible, whereby the structure is secured to the trolley by the fastenings of the suspension system.
    - 1.3.4. The angle between the longitudinal axis of the vehicle and the direction of motion of the trolley shall be  $0^\circ \pm 2^\circ$ .
  - 1.4. Dummies

The dummies and their positioning shall conform to the specifications in Annex 3, paragraph 2.
  - 1.5. Measuring apparatus
    - 1.5.1. Deceleration of the structure

The position of the transducers measuring the deceleration of the structure during the impact shall be parallel to the longitudinal axis of the trolley according to the specifications of Annex 8 (CFC 180).
    - 1.5.2. Measurements to be made on the dummies

All the measurements necessary for checking the listed criteria are set out in Annex 3, paragraph 5.

1.6. Deceleration curve of the structure

The deceleration curve of the structure during the impact phase shall be such that the "variation of speed in relation to time" curve obtained by integration at no point differs by more than  $\pm 1$  m/s from the "variation of speed in relation to time" reference curve of the vehicle concerned as defined in appendix to this annex. A displacement with regard to the time axis of the reference curve may be used to obtain the structure velocity inside the corridor.

1.7. Reference curve  $\Delta V = f(t)$  of the vehicle concerned

This reference curve is obtained by integration of the deceleration curve of the vehicle concerned measured in the frontal collision test against a barrier as provided for in paragraph 6. of Annex 3 to this Regulation.

1.8. Equivalent method

The test may be performed by some other method than that of deceleration of a trolley, provided that such method complies with the requirement concerning the range of variation of speed described in paragraph 1.6. above.

## Annex 7 - Appendix

### Equivalence curve - tolerance band for curve $\Delta V = f(t)$

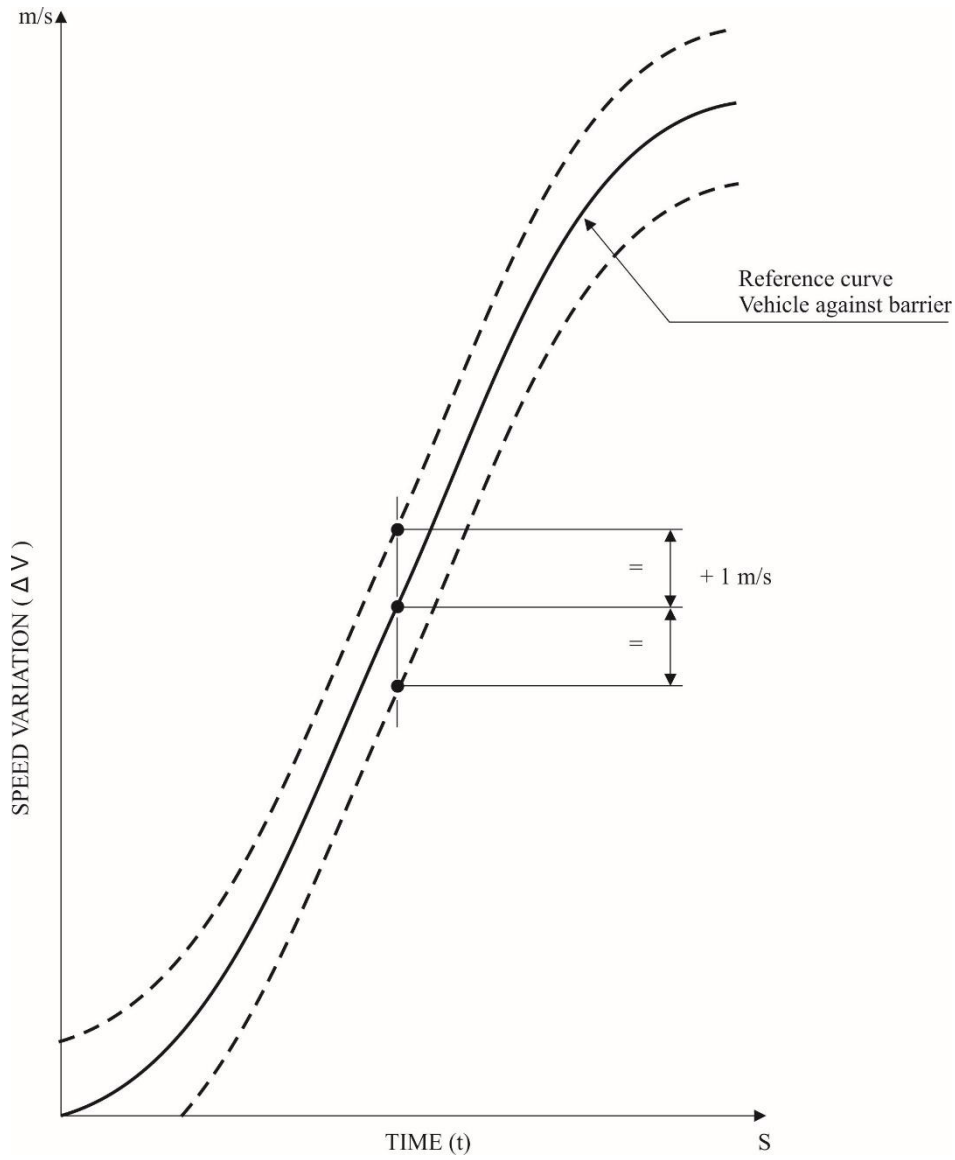



## Annex 8

### Technique of measurement in measurement tests: Instrumentation

1. Definitions
  - 1.1. Data channel

A data channel comprises all the instrumentation from a transducer (or multiple transducers whose outputs are combined in some specified way) up to and including any analysis procedures that may alter the frequency content or the amplitude content of data.
  - 1.2. Transducer

The first device in a data channel used to convert a physical quantity to be measured into a second quantity (such as an electrical voltage) which can be processed by the remainder of the channel.
  - 1.3. Channel Amplitude Class: CAC

The designation for a data channel that meets certain amplitude characteristics as specified in this annex. The CAC number is numerically equal to the upper limit of the measurement range.
  - 1.4. Characteristic frequencies  $F_H$ ,  $F_L$ ,  $F_N$ 

These frequencies are defined in Figure 1 of this annex.
  - 1.5. Channels Frequency Class: CFC

The channel frequency class is designated by a number indicating that the channel frequency response lies within the limits specified in Figure 1 of this annex. This number and the value of the frequency  $F_H$  in Hz are numerically equal.
  - 1.6. Sensitivity coefficient

The slope of the straight line representing the best fit to the calibration values determined by the method of least square within the channel amplitude class.
  - 1.7. Calibration factor of a data channel

The mean value of the sensitivity coefficients evaluated over frequencies which are evenly spaced on a logarithmic scale between  $F_L$  and  $\frac{F_H}{2.5}$
  - 1.8. Linearity error

The ratio, in per cent, of the maximum difference between the calibration value and the corresponding value read on the straight line defined in paragraph 1.6. above at the upper limit of the channel amplitude class.
  - 1.9. Cross sensitivity

The ratio of the output signal to the input signal, when an excitation is applied to the transducer perpendicular to the measurement axis. It is expressed as a percentage of the sensitivity along the measurement axis.

- 1.10. Phase delay time  
The phase delay time of a data channel is equal to the phase delay (in radians) of a sinusoidal signal, divided by the angular frequency of that signal (in radians/second).
- 1.11. Environment  
The aggregate, at a given moment, of all external conditions and influences to which the data channel is subjected.
2. Performance requirements
- 2.1. Linearity error  
The absolute value of the linearity error of a data channel at any frequency in the CFC, shall be equal to or less than 2.5 per cent of the value of the CAC, over the whole measurement range.
- 2.2. Amplitude against frequency  
The frequency response of a data channel shall lie within the limiting curves given in Figure 1 of this annex. The zero dB line is determined by the calibration factor.
- 2.3. Phase delay time  
The phase delay time between the input and the output signals of a data channel shall be determined and shall not vary by more than  $1/10 F_H$  seconds between  $0.03 F_H$  and  $F_H$ .
- 2.4. Time
- 2.4.1. Time base  
A time base shall be recorded and shall at least give  $1/100$  s with an accuracy of 1 per cent.
- 2.4.2. Relative time delay  
The relative time delay between the signal of two or more data channels, regardless of their frequency class, shall not exceed 1 ms excluding delay caused by phase shift.  
Two or more data channels of which the signals are combined shall have the same frequency class and shall not have relative time delay greater than  $1/10 F_H$  seconds.  
This requirement applies to analogue signals as well as to synchronization pulses and digital signals.
- 2.5. Transducer cross sensitivity  
The transducer cross sensitivity shall be less than 5 per cent in any direction.
- 2.6. Calibration
- 2.6.1. General  
A data channel shall be calibrated at least once a year against reference equipment traceable to known standards. The methods used to carry out a comparison with reference equipment shall not introduce an error greater than 1 per cent of the CAC. The use of the reference equipment is limited to the

frequency range for which they have been calibrated. Subsystems of a data channel may be evaluated individually and the results factored into the accuracy of the total data channel. This can be done for example by an electrical signal of known amplitude simulating the output signal of the transducer which allows a check to be made on the gain factor of the data channel, excluding the transducer.

2.6.2. Accuracy of reference equipment for calibration

The accuracy of the reference equipment shall be certified or endorsed by an official metrology service.

2.6.2.1. Static calibration

2.6.2.1.1. Accelerations

The errors shall be less than  $\pm 1.5$  per cent of the channel amplitude class.

2.6.2.1.2. Forces

The error shall be less than  $\pm 1$  per cent of the channel amplitude class.

2.6.2.1.3. Displacements

The error shall be less than  $\pm 1$  per cent of the channel amplitude class.

2.6.2.2. Dynamic calibration

2.6.2.2.1. Accelerations

The error in the reference accelerations expressed as a percentage of the channel amplitude class shall be less than  $\pm 1.5$  per cent below 400 Hz, less than  $\pm 2$  per cent between 400 Hz and 900 Hz, and less than  $\pm 2.5$  per cent above 900 Hz.

2.6.2.3. Time

The relative error in the reference time shall be less than  $10^{-5}$ .

2.6.3. Sensitivity coefficient and linearity error

The sensitivity coefficient and the linearity error shall be determined by measuring the output signal of the data channel against a known input signal for various values of this signal. The calibration of the data channel shall cover the whole range of the amplitude class.

For bi-directional channels, both the positive and negative values shall be used.

If the calibration equipment cannot produce the required input owing to the excessively high values of the quantity to be measured, calibrations shall be carried out within the limits of the calibration standards and these limits shall be recorded in the test report.

A total data channel shall be calibrated at a frequency or at a spectrum of frequencies having a significant value between  $F_L$  and  $\frac{F_H}{2.5}$ .

- 2.6.4. Calibration of the frequency response
- The response curves of phase and amplitude against frequency shall be determined by measuring the output signals of the data channel in terms of phase and amplitude against a known input signal, for various values of this signal varying between  $F_L$  and 10 times the CFC or 3,000 Hz, whichever is lower.
- 2.7. Environmental effects
- A regular check shall be made to identify any environmental influence (such as electric or magnetic flux, cable velocity, etc.). This can be done for instance by recording the output of spare channels equipped with dummy transducers. If significant output signals are obtained corrective action shall be taken, for instance by replacement of cables.
- 2.8. Choice and designation of the data channel
- The CAC and CFC define a data channel.
- The CAC shall be 1, 2 or 5 to a power of ten.
3. Mounting of transducers
- Transducers should be rigidly secured so that their recordings are affected by vibration as little as possible. Any mounting having a lowest resonance frequency equal to at least 5 times the frequency  $F_H$  of the data channel considered shall be considered valid. Acceleration transducers in particular should be mounted in such a way that the initial angle of the real measurement axis to the corresponding axis of the reference axis system is not greater than  $5^\circ$  unless an analytical or experimental assessment of the effect of the mounting on the collected data is made. When multi-axial accelerations at a point are to be measured, each acceleration transducer axis should pass within 10 mm of that point, and the centre of seismic mass of each accelerometer should be within 30 mm of that point.
4. Data processing
- 4.1. Filtering
- Filtering corresponding to the frequencies of the data channel class may be carried out during either recording or processing of data. However, before recording, analogical filtering at a higher level than CFC should be effected in order to use at least 50 per cent of the dynamic range of the recorder and to reduce the risk of high frequencies saturating the recorder or causing aliasing errors in the digitalizing process.
- 4.2. Digitalizing
- 4.2.1. Sampling frequency
- The sampling frequency should be equal to at least  $8 F_H$ .
- 4.2.2. Amplitude resolution
- The size of digital words should be at least 7 bits and a parity bit.
5. Presentation of results
- The results should be presented on A4 size paper (ISO/R 216). Results presented as diagrams should have axes scaled with a measurement unit

corresponding to a suitable multiple of the chosen unit (for example, 1, 2, 5, 10, 20 millimetres). SI units shall be used, except for vehicle velocity, where km/h may be used, and for accelerations due to impact where g, with  $g = 9.8 \text{ m/s}^2$ , may be used.

Figure 1  
**Frequency response curve**

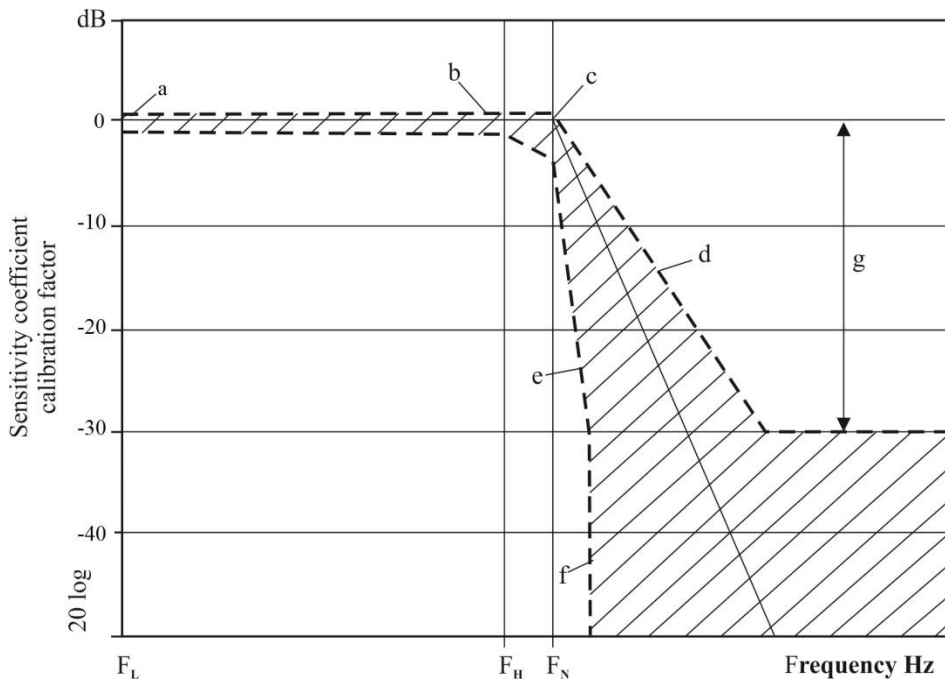

CFC	$F_L$ Hz	$F_H$ Hz	$F_N$ Hz	$N$	Logarithmic scale		
1,000	$\leq 0.1$	1,000	1,650	a	$\pm$	0.5	dB
600	$\leq 0.1$	600	1,000	b	+	0.5; -1	dB
180	$\leq 0.1$	180	300	c	+	0.5; -4	dB
60	$\leq 0.1$	60	100	d	-	9	dB/octave
				e	-	24	dB/octave
				f		$\infty$	
				g	-	30	

## Annex 9

### **Test procedures for the protection of the occupants of vehicles operating on electrical power from high voltage and electrolyte spillage**

This annex describes test procedures to demonstrate compliance to the electrical safety requirements of paragraph 5.2.8. of this Regulation. For example, megohmmeter or oscilloscope measurements are an appropriate alternative to the procedure described below for measuring isolation resistance. In this case it may be necessary to deactivate the on-board isolation resistance monitoring system.

Before the vehicle impact test conducted, the high voltage bus voltage ( $V_b$ ) (see Figure 1 below) shall be measured and recorded to confirm that it is within the operating voltage of the vehicle as specified by the vehicle manufacturer.

1. Test setup and equipment

If a high voltage disconnect function is used, measurements are to be taken from both sides of the device performing the disconnect function.

However, if the high voltage disconnect is integral to the REESS or the energy conversion system and the high-voltage bus of the REESS or the energy conversion system is protected according to protection IPXXB following the impact test, measurements may only be taken between the device performing the disconnect function and the electrical loads.

The voltmeter used in this test shall measure DC values and have an internal resistance of at least 10 M $\Omega$ .

2. The following instructions may be used if voltage is measured.

After the impact test, determine the high voltage bus voltages ( $V_b$ ,  $V_1$ ,  $V_2$ ) (see Figure 1 below).

The voltage measurement shall be made not earlier than 5 seconds, but, not later than 60 seconds after the impact.

This procedure is not applicable if the test is performed under the condition where the electric power train is not energized.

Figure 1  
**Measurement of  $V_b$ ,  $V_1$ ,  $V_2$**

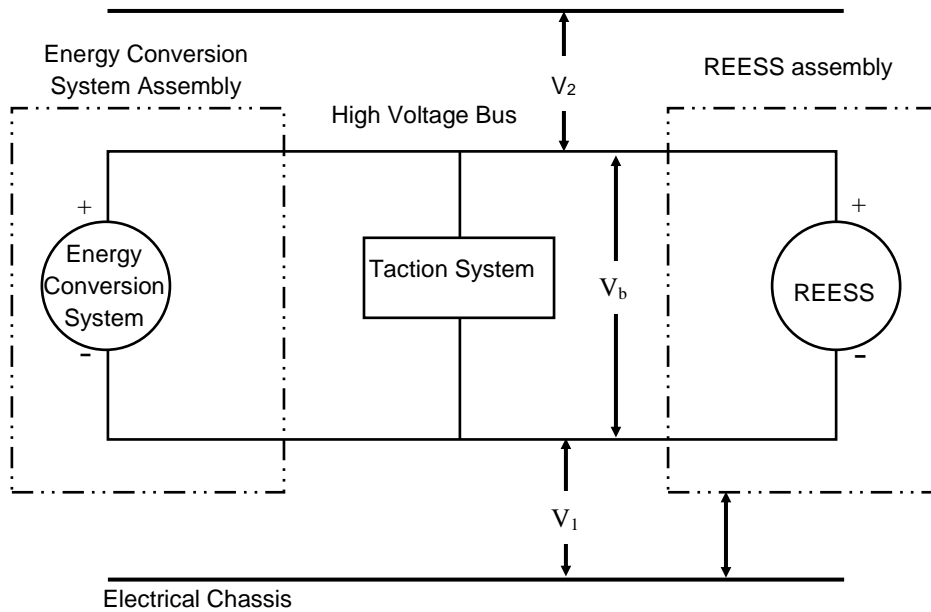

3. Assessment procedure for low electrical energy

Prior to the impact a switch  $S_1$  and a known discharge resistor  $R_e$  is connected in parallel to the relevant capacitance (ref. Figure 2 below).

Not earlier than 5 seconds and not later than 60 seconds after the impact the switch  $S_1$  shall be closed while the voltage  $V_b$  and the current  $I_e$  are measured and recorded. The product of the voltage  $V_b$  and the current  $I_e$  shall be integrated over the period of time, starting from the moment when the switch  $S_1$  is closed ( $t_c$ ) until the voltage  $V_b$  falls below the high voltage threshold of 60 V DC ( $t_h$ ). The resulting integration equals the Total Energy (TE) in Joules.

$$(a) \quad TE = \int_{t_c}^{t_h} V_b \times I_e dt$$

When  $V_b$  is measured at a point in time between 5 seconds and 60 seconds after the impact and the capacitance of the X-capacitors ( $C_x$ ) is specified by the manufacturer, Total Energy (TE) shall be calculated according to the following formula:

$$(b) \quad TE = 0.5 \times C_x \times (V_b^2 - 3,600)$$

When  $V_1$  and  $V_2$  (see Figure 1 above) are measured at a point in time between 5 seconds and 60 seconds after the impact and the capacitances of the Y-capacitors ( $C_{y1}$ ,  $C_{y2}$ ) are specified by the manufacturer, total energy ( $TE_{y1}$ ,  $TE_{y2}$ ) shall be calculated according to the following formulas:

$$(c) \quad TE_{y1} = 0.5 \times C_{y1} \times (V_1^2 - 3,600)$$

$$TE_{y2} = 0.5 \times C_{y2} \times (V_2^2 - 3,600)$$

This procedure is not applicable if the test is performed under the condition where the electric power train is not energized.

Figure 2  
**E.g. measurement of high voltage bus energy stored in X-capacitors**

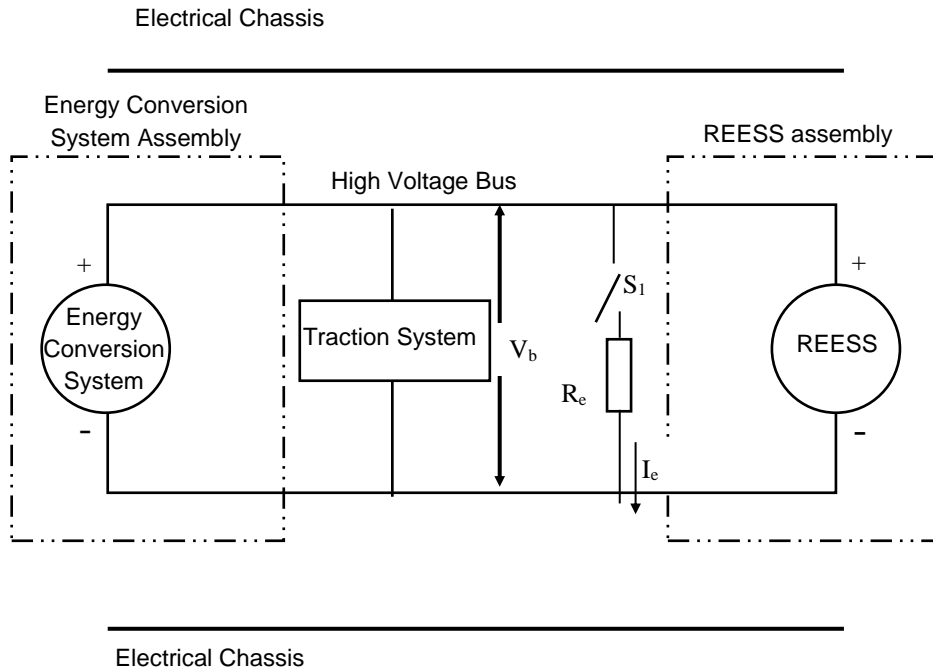

4. Physical protection

Following the vehicle impact test any parts surrounding the high voltage components shall be, without the use of tools, opened, disassembled or removed. All remaining surrounding parts shall be considered part of the physical protection.

The jointed test finger described in Figure 1 of Appendix 1 shall be inserted into any gaps or openings of the physical protection with a test force of  $10 \text{ N} \pm 10$  per cent for electrical safety assessment. If partial or full penetration into the physical protection by the jointed test finger occurs, the jointed test finger shall be placed in every position as specified below.

Starting from the straight position, both joints of the test finger shall be rotated progressively through an angle of up to 90 degrees with respect to the axis of the adjoining section of the finger and shall be placed in every possible position.

Internal electrical protection barriers are considered part of the enclosure

If appropriate a low-voltage supply (of not less than 40 V and not more than 50 V) in series with a suitable lamp should be connected, between the jointed test finger and high voltage live parts inside the electrical protection barrier or enclosure.



4.1. Acceptance conditions

The requirements of paragraph 5.2.8.1.3. of this Regulation shall be considered to be met if the jointed test finger described in Figure 1 of Appendix 1, is unable to contact high voltage live parts.

If necessary a mirror or a fiberscope may be used in order to inspect whether the jointed test finger touches the high voltage buses.

If this requirement is verified by a signal circuit between the jointed test finger and high voltage live parts, the lamp shall not light.

5. Isolation resistance

The isolation resistance between the high voltage bus and the electrical chassis may be demonstrated either by measurement or by a combination of measurement and calculation.

The following instructions should be used if the isolation resistance is demonstrated by measurement.

Measure and record the voltage ( $V_b$ ) between the negative and the positive side of the high voltage bus (see Figure 1 above);

Measure and record the voltage ( $V_1$ ) between the negative side of the high voltage bus and the electrical chassis (see Figure 1 above);

Measure and record the voltage ( $V_2$ ) between the positive side of the high voltage bus and the electrical chassis (see Figure 1 above);

If  $V_1$  is greater than or equal to  $V_2$ , insert a standard known resistance ( $R_o$ ) between the negative side of the high voltage bus and the electrical chassis. With  $R_o$  installed, measure the voltage ( $V_1'$ ) between the negative side of the high voltage bus and the vehicle electrical chassis (see Figure 3 below).

Calculate the isolation resistance ( $R_i$ ) according to the formula shown below.

$$R_i = R_o \times (V_b / V_1' - V_b / V_1) \quad \text{or} \quad R_i = R_o \times V_b \times (1 / V_1' - 1 / V_1)$$

Divide the result  $R_i$ , which is the electrical isolation resistance value in Ohm ( $\Omega$ ), by the working voltage of the high voltage bus in Volt (V).

$$R_i (\Omega / V) = R_i (\Omega) / \text{Working voltage (V)}$$

Figure 3  
**Measurement of  $V_1'$**

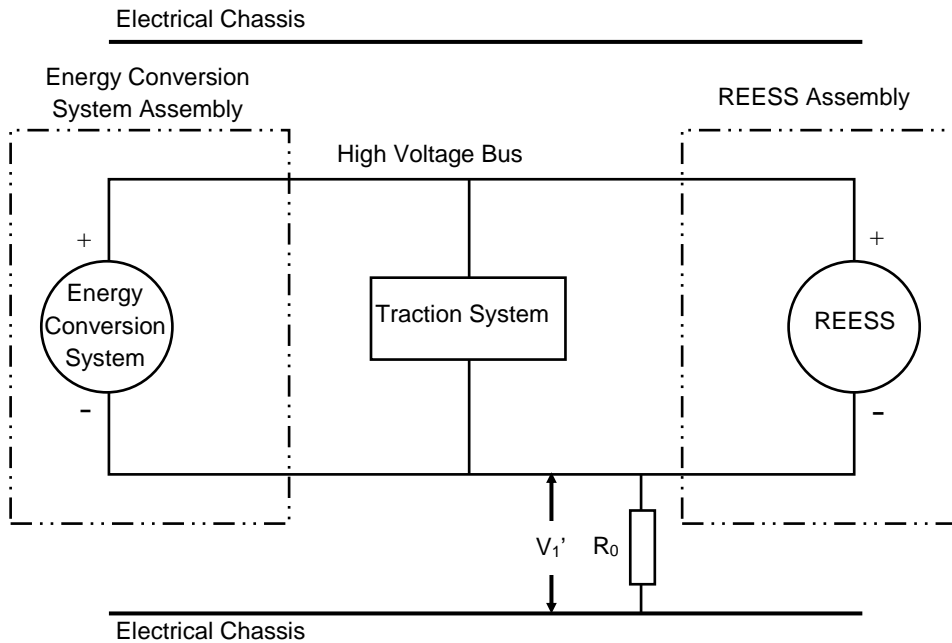

If  $V_2$  is greater than  $V_1$ , insert a standard known resistance ( $R_0$ ) between the positive side of the high voltage bus and the electrical chassis. With  $R_0$  installed, measure the voltage ( $V_2'$ ) between the positive side of the high voltage bus and the electrical chassis (see Figure 4 below).

Calculate the isolation resistance ( $R_i$ ) according to the formula shown below.

$$R_i = R_0 \times (V_b / V_2' - V_b / V_2) \quad \text{or} \quad R_i = R_0 \times V_b \times (1 / V_2' - 1 / V_2)$$

Divide the result  $R_i$ , which is the electrical isolation resistance value in Ohm ( $\Omega$ ), by the working voltage of the high voltage bus in Volt (V).

$$R_i (\Omega / V) = R_i (\Omega) / \text{Working voltage (V)}$$

Figure 4  
 Measurement of  $V_2'$

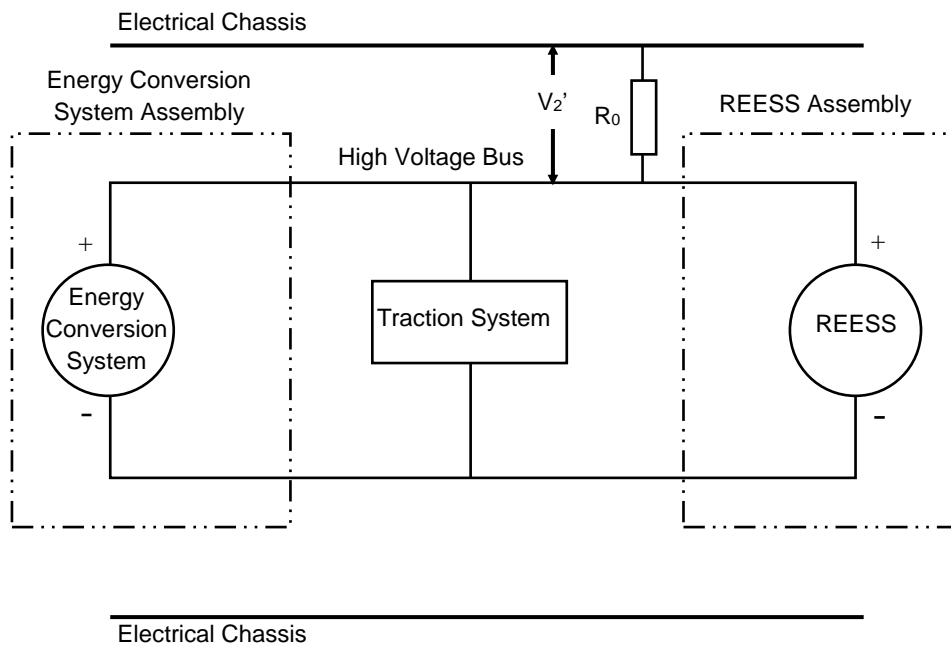

*Note:* The standard known resistance  $R_o$  (in  $\Omega$ ) should be the value of the minimum required isolation resistance ( $\Omega/V$ ) multiplied by the working voltage (V) of the vehicle plus/minus 20 per cent.  $R_o$  is not required to be precisely this value since the equations are valid for any  $R_o$ ; however, a  $R_o$  value in this range should provide a good resolution for the voltage measurements.

6. Electrolyte spillage  
 Appropriate coating shall be applied, if necessary, to the physical protection in order to confirm any electrolyte leakage from the REESS after the impact test.  
 Unless the manufacturer provides means to differentiate between the leakage of different liquids, all liquid leakage shall be considered as the electrolyte.
7. REESS retention  
 Compliance shall be determined by visual inspection.

## Annex 9 - Appendix

### Jointed test finger (IPXXB)

Figure 1  
 Jointed test finger

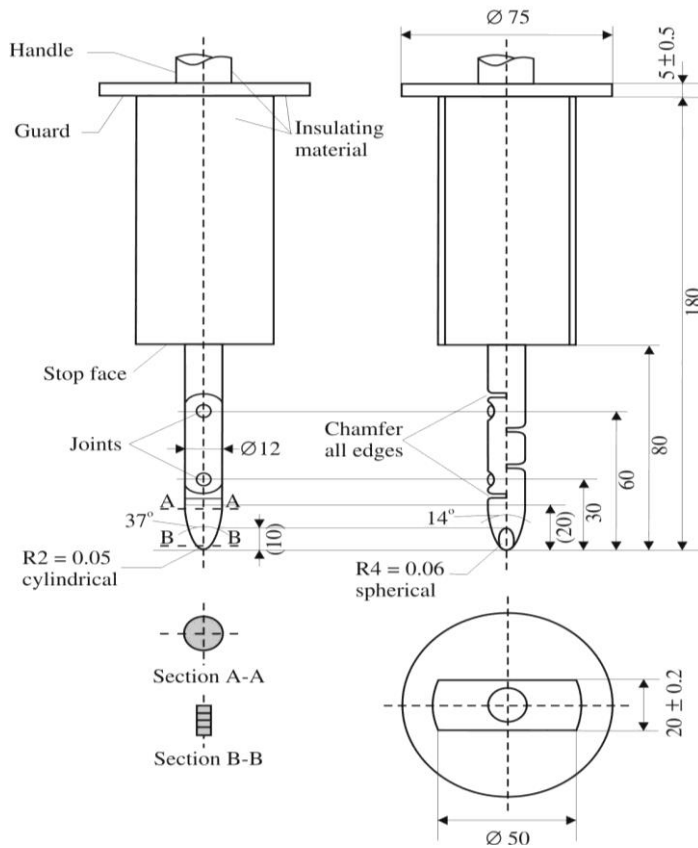

Material: metal, except where otherwise specified

Linear dimensions in millimetres

Tolerances on dimensions without specific tolerance:

- (a) On angles:  $0/-10^\circ$ ;
- (b) On linear dimensions: up to 25 mm:  $0/-0.05$  mm over 25 mm:  $\pm 0.2$  mm.

Both joints shall permit movement in the same plane and the same direction through an angle of  $90^\circ$  with a  $0$  to  $+10^\circ$  tolerance.