

6 August 2013

---

## **Agreement**

### **Concerning the Adoption of Uniform Technical Prescriptions for Wheeled Vehicles, Equipment and Parts which can be Fitted and/or be Used on Wheeled Vehicles and the Conditions for Reciprocal Recognition of Approvals Granted on the Basis of these Prescriptions\***

(Revision 2, including the amendments which entered into force on 16 October 1995)

---

#### **Addendum 48 – Regulation No. 49**

#### **Revision 6 - Amendment 1**

Supplement 1 to the 06 series of amendments – Date of entry into force: 15 July 2013

#### **Uniform provisions concerning the measures to be taken against the emission of gaseous and particulate pollutants from compression-ignition engines and positive ignition engines for use in vehicles**



**UNITED NATIONS**

---

\* Former title of the Agreement: Agreement Concerning the Adoption of Uniform Conditions of Approval and Reciprocal Recognition of Approval for Motor Vehicle Equipment and Parts, done at Geneva on 20 March 1958.

*Insert a new paragraph 2.13., to read:*

"2.13. "Diesel mode" means the normal operating mode of a dual-fuel engine during which the engine does not use any gaseous fuel for any engine operating condition;"

*Paragraph 2.13. (former), renumber as paragraph 2.14.*

*Insert new paragraphs 2.15. to 2.17., to read:*

"2.15. "Dual-fuel engine" means an engine system that is designed to simultaneously operate with diesel fuel and a gaseous fuel, both fuels being metered separately, where the consumed amount of one of the fuels relative to the other one may vary depending on the operation;

2.16. "Dual-fuel mode" means the normal operating mode of a dual-fuel engine during which the engine simultaneously uses diesel fuel and a gaseous fuel at some engine operating conditions;

2.17. "Dual-fuel vehicle" means a vehicle that is powered by a dual-fuel engine and that supplies the fuels used by the engine from separate on-board storage systems;"

*Paragraphs 2.14. (former) to 2.54 (former)., renumber as paragraphs 2.18. to 2.58.*

*Insert a new paragraph 2.59., to read (including footnote 2):*

"2.59. "Service mode" means a special mode of a dual-fuel engine that is activated for the purpose of repairing, or of moving the vehicle from the traffic when operation in the dual-fuel mode is not possible<sup>2</sup>.

---

<sup>2</sup> For example in case of an empty gas tank."

*Paragraphs 2.55. (former) to 2.61 (former)., renumber as paragraphs 2.60. to 2.67.*

*Paragraph 4.3., amend to read (deleting also footnote 2):*

"4.3. In order to receive a type-approval of a dual-fuel engine or engine family as a separate technical unit, type-approval of a dual-fuel vehicle with an approved dual-fuel engine with regard to emissions, or a type-approval of a dual-fuel vehicle with regard to emissions, the manufacturer shall, in addition to the requirements of paragraph 4.1. demonstrate that the dual-fuel vehicles or engine are subject to the tests and comply with the requirements set out in Annex 15."

*Insert a new paragraph 4.5.1., to read:*

"4.5.1. Tables summarizing the requirements for approval of NG-Fuelled engines, LPG-Fuelled engines and dual-fuelled engines are provided in Appendix 4."

*Paragraph 4.6.1., amend to read:*

"4.6.1. The parent engine shall meet the requirements of this Regulation on the appropriate reference fuels specified in Annex 5. Specific requirements shall apply to engines fuelled with natural gas/biomethane (including dual-fuel engines), as laid down in paragraph 4.6.3."

*Paragraph 4.6.3.*, divide in paragraphs 4.6.3. and 4.6.3.1. and amend to read:

"4.6.3. In the case of a natural gas/biomethane fuelled engine the manufacturer shall demonstrate the parent engines capability to adapt to any fuel composition that may occur across the market.

4.6.3.1. In the case of compressed natural gas/biomethane (CNG) there are generally two types of fuel, high calorific fuel (H-gas) and low calorific fuel (L-gas), but with a significant spread within both ranges; they differ significantly in their energy content expressed by the Wobbe Index and in their  $\lambda$ -shift factor ( $S_\lambda$ ). Natural gases with a  $\lambda$ -shift factor between 0.89 and 1.08 ( $0.89 \leq S_\lambda \leq 1.08$ ) are considered to belong to H-range, while natural gases with a  $\lambda$ -shift factor between 1.08 and 1.19 ( $1.08 \leq S_\lambda \leq 1.19$ ) are considered to belong to L-range. The composition of the reference fuels reflects the extreme variations of  $S_\lambda$ .

The parent engine shall meet the requirements of this Regulation on the reference fuels  $G_R$  (fuel 1) and  $G_{25}$  (fuel 2), as specified in Annex 5, without any manual readjustment to the engine fuelling system between the two tests (self-adaptation is required). One adaptation run over one WHTC hot cycle without measurement is permitted after the change of the fuel. After the adaptation run the engine shall be cooled down in accordance with paragraph 7.6.1. of Annex 4."

*Paragraph 4.6.3.1. (former)*, renumber as 4.6.3.1.1.

*Insert a new paragraph 4.6.3.2.*, to read:

"4.6.3.2. In the case of liquefied natural gas/liquefied biomethane (LNG) the parent engine shall meet the requirements of this Regulation on the reference fuels  $G_R$  (fuel 1) and  $G_{20}$  (fuel 2), as specified in Annex 5, without any manual readjustment to the engine fuelling system between the two tests (self-adaptation is required). One adaptation run over one WHTC hot cycle without measurement is permitted after the change of the fuel. After the adaptation run, the engine shall be cooled down in accordance with paragraph 7.6.1. of Annex 4."

*Paragraph 4.6.4.*, amend to read:

"4.6.4. In the case of an engine fuelled with compressed natural gas/biomethane (CNG) which is self-adaptive for the range of H-gases on the one hand and the range of L-gases on the other hand, and which switches between the H-range and the L-range by means of a switch, the parent engine shall be tested on the relevant reference fuel as specified in Annex 5 for each range, at each position of the switch. ..."

*Paragraph 4.7.*, amend to read:

"4.7. Requirements on restricted fuel range type-approval in case of positive ignition engines fuelled with compressed natural gas/biomethane (CNG) or LPG.  
..."

*Insert new paragraphs 4.8. to 4.8.2.1.*, to read (including a new footnote 4):

"4.8. Requirements on fuel-specific type-approval in the case of engines fuelled with liquefied natural gas/liquefied biomethane (LNG)

- In case of liquefied natural gas/liquefied biomethane, a fuel specific type-approval may be granted subject to the requirements specified in paragraphs 4.8.1. to 4.8.2.
- 4.8.1. Conditions for applying for a fuel-specific type approval in the case of engines fuelled with liquefied natural gas/liquefied biomethane (LNG).
- 4.8.1.1. The manufacturer can only apply for a fuel specific type-approval in the case of the engine being calibrated for a specific LNG gas composition<sup>4</sup> resulting in a  $\lambda$ -shift factor not differing by more than 3 per cent from the  $\lambda$ -shift factor of the G<sub>20</sub> fuel specified in Annex 5; and the ethane content of which does not exceed 1.5 per cent.
- 4.8.1.2. In all other cases the manufacturer shall apply for a universal fuel type approval according to the specifications of paragraph 4.6.3.2.
- 4.8.2. Specific test requirements in the case of a fuel-specific type approval (LNG).
- 4.8.2.1. In the case of a dual-fuel engine family where the engines are calibrated for a specific LNG gas composition<sup>2</sup> resulting in a  $\lambda$ -shift factor not differing by more than 3 per cent from the  $\lambda$ -shift factor of the G<sub>20</sub> fuel specified in Annex 5, and the ethane content of which does not exceed 1.5 per cent, the parent engine shall only be tested on the G<sub>20</sub> reference gas fuel, as specified in Annex 5.

---

<sup>4</sup> This would typically be the case of a liquefied bio-methane."

*Paragraphs 4.8. (former) to 4.8.2. (former), renumber as paragraphs 4.9. to 4.9.2.*

*Paragraphs 4.9. (former), delete.*

*Footnotes 4 to 5 (former), renumber as 5 to 6.*

*Paragraph 4.12.3.3.6., amend to read:*

"4.12.3.3.6. ...

- (f) HLT in the case of the engine being approved and calibrated for a specific gas composition in either the H-range or the L-range of gases and transformable to another specific gas in either the H-range or the L-range of gases by fine tuning of the engine fuelling;
- (g) LNG<sub>20</sub> in case of the engine being approved and calibrated for a specific liquefied natural gas / liquefied biomethane composition resulting in a  $\lambda$ -shift factor not differing by more than 3 per cent the  $\lambda$ -shift factor of the G<sub>20</sub> gas specified in Annex 5, and the ethane content of which does not exceed 1.5 per cent;
- (h) LNG in case of the engine being approved and calibrated for any other liquefied natural gas / liquefied biomethane composition."

*Insert a new paragraph 4.12.3.3.7., to read:*

"4.12.3.3.7. For dual-fuel engines the approval mark shall contain a series of digits after the national symbol, the purpose of which is to distinguish for which dual-fuel engine type and with which range of gases the approval has been granted.

This series of digits will be constituted of two digits for the dual-fuel type followed by the letter(s) specified in paragraphs 4.12.3.3.1. to 4.12.3.3.6. as appropriate.

The two digits identifying the dual-fuel engines types according to the definitions of Annex 15 are the following:

- (a) 1A for dual-fuel engines of Type 1A;
- (b) 1B for dual-fuel engines of Type 1B;
- (c) 2A for dual-fuel engines of Type 2A;
- (d) 2B for dual-fuel engines of Type 2B;
- (e) 3B for dual-fuel engines of Type 3B."

*Insert a new paragraph 6.2.1., to read:*

"6.2.1. The installation of a dual-fuel engine type-approved as a separate technical unit on a vehicle shall, in addition, meet the requirements of paragraph 6.3. of Annex 15 and, according to section 8.2. of Annex 15, meet the manufacturer's installation requirements as specified in Part 1 of Annex 1."

*Paragraph 7.1., amend to read:*

"7.1. Parameters defining the engine family

The engine family, as determined by the engine manufacturer shall comply with paragraph 5.2. of Annex 4.

In case of a dual-fuel engine, the engine family shall also comply with the additional requirements of paragraph 3.1.1. of Annex 15."

*Paragraph 7.2., amend to read:*

"7.2. Choice of the parent engine

The parent engine of the family shall be selected in accordance with the requirements set out in paragraph 5.2.4. of Annex 4.

In case of a dual-fuel engine, the parent engine family shall also comply with the additional requirements of paragraph 3.1.2. of Annex 15."

*Insert new paragraphs 7.3. to 7.3.3., to read:*

"7.3. Extension to include a new engine system into an engine-family

7.3.1. At the request of the manufacturer and upon approval of the Type Approval Authority, a new engine system may be included as a member of a certified engine family if the criteria specified in paragraph 7.1. are met.

7.3.2. If the elements of design of the parent engine system are representative of those of the new engine system according to paragraph 7.2. or, in the case of dual-fuel engines, to paragraph 3.1.2. of Annex 15, then the parent engine system shall remain unchanged and the manufacturer shall modify the information document specified in Annex 1.

7.3.3. If the new engine system contains elements of design that are not represented by the parent engine system according to paragraph 7.2. or, in the case of dual-fuel engines, to paragraph 3.1.2. of Annex 15, but itself would represent the whole family according to these paragraphs, then the new engine system shall become the new parent engine. In this case the new elements of design

shall be demonstrated to comply with the provisions of this Regulation and the information document specified in Annex 1 shall be modified."

Paragraph 7.3. (former), renumber as paragraph 7.4.

Appendix 4, the title, amend to read:

**"Summary of approval process for engines fuelled with natural gas, engines fuelled with LPG and dual-fuel engines fuelled with natural gas/biomethane or LPG"**

Appendix 4, insert a new table at the end, to read:

**"Approval for dual-fuel engines fuelled with natural gas/biomethane or LPG"**

Dual-fuel type <sup>1</sup>	Diesel mode	Dual-fuel mode			
		CNG	LNG	LNG20	LPG
1A		Universal or restricted (2 tests)	Universal (2 tests)	Fuel specific (1 test)	Universal or restricted (2 tests)
1B	Universal (1 test)	Universal or restricted (2 tests)	Universal (2 tests)	Fuel specific (1 test)	Universal or restricted (2 tests)
2A		Universal or restricted (2 tests)	Universal (2 tests)	Fuel specific (1 test)	Universal or restricted (2 tests)
2B	Universal (1 test)	Universal or restricted (2 tests)	Universal (2 tests)	Fuel specific (1 test)	Universal or restricted (2 tests)
3B	Universal (1 test)	Universal or restricted (2 tests)	Universal (2 tests)	Fuel specific (1 test)	Universal or restricted (2 tests)

<sup>1</sup> According to the definitions of Annex 15.

Annex 1,

Part 1, the table, amend to read (also inserting new rows) and add new footnotes:

**"Essential characteristics of the (parent) engine and the engine types within an engine family**

		Parent engine or engine type	Engine family members				
			A	B	C	D	E
...	...						
3.2.1.1.	Working principle: positive ignition/compression ignition/dual-fuel <sup>1</sup> Cycle four stroke / two stroke/ rotary <sup>1</sup>						
3.2.1.1.1.	Type of dual-fuel engine: Type 1A/Type 1B/Type 2A/Type 2B/Type 3B <sup>1,14</sup> Gas Energy Ratio over the hot part of the WHTC test-cycle <sup>14</sup> : .....%						
...	...						
3.2.1.6.2.	Idle on Diesel: yes/no <sup>1,14</sup>						
...	...						
3.2.2.2.	Heavy duty vehicles Diesel/Petrol/LPG/NG-H/NG-L/NG-HL/Ethanol (ED95)/Ethanol (E85)/dual-fuel <sup>1,15</sup>						
...	...						
3.2.4.2.	By fuel injection (only compression ignition or dual-fuel): yes/no <sup>1</sup>						
...	...						
3.2.12.7.0.6.	When appropriate, manufacturer reference of the documentation for installing the dual-fuel engine in a vehicle						
...	...						
3.2.17.	Specific information related to gas fuelled engines and dual-fuel engines for heavy-duty vehicles (in the case of systems laid out in a different manner, supply equivalent information)						
...	...						
3.5.4.1.	CO <sub>2</sub> mass emissions WHSC test <sup>16</sup> : ..... (g/kWh)						
3.5.4.1.1.	For dual-fuel engines, CO <sub>2</sub> mass emissions WHSC test in diesel mode <sup>13</sup> : .....g/kWh For dual-fuel engines, CO <sub>2</sub> mass emissions WHSC test in dual-fuel mode <sup>13</sup> (if applicable): ..... g/kWh						
3.5.4.2.	CO <sub>2</sub> mass emissions WHTC test <sup>16</sup> : ..... (g/kWh)						
3.5.4.2.1.	For dual-fuel engines, CO <sub>2</sub> mass emissions WHTC test in diesel mode <sup>13</sup> : ..... g/kWh For dual-fuel engines, CO <sub>2</sub> mass emissions WHTC test in dual-fuel mode <sup>13</sup> :						

		Parent engine or engine type	Engine family members				
			A	B	C	D	E
	..... g/kWh						
3.5.5.	Fuel consumption for heavy duty engines						
3.5.5.1.	Fuel consumption WHSC test <sup>16</sup> : .....						
3.5.5.1.1.	For dual-fuel engines, fuel consumption WHSC test in diesel mode <sup>13</sup> : ..... g/kWh For dual-fuel engines, fuel consumption WHSC test in dual-fuel mode <sup>13</sup> : ..... g/kWh						
3.5.5.2.	Fuel consumption WHTC test <sup>5,16</sup> : ..... (g/kWh)						
3.5.5.2.1.	For dual-fuel engines, fuel consumption WHTC test in diesel mode <sup>13</sup> : ..... g/kWh For dual-fuel engines, fuel consumption WHTC test in dual-fuel mode <sup>13</sup> : ..... g/kWh						
...	...						

Notes:

- ...
- 12 Delete as appropriate.
- 13 When required by this Regulation.
- 14 In case of a dual-fuel engine or vehicle (types as defined in Annex 15).
- 15 In case of a dual-fuel engine or vehicle, the type of gaseous fuel used in dual-fuel mode shall not be struck out.
- 16 Except for dual-fuel engines or vehicles (types as defined in Annex 15)."

Annex 1,

Appendix to information document, paragraph 5.1., amend to read and insert a new footnote \*:

"5.1. Engine test speeds for emissions test according to Annex 4<sup>2</sup> or engine test speeds for emissions test in dual-fuel mode according to Annex 4<sup>2,\*</sup>

\* In case of a dual-fuel engine or vehicle (types as defined in Annex 15)."

Insert a new paragraph 5.1.1., to read and insert a new footnote \*\*::

"5.1.1. Engine test speeds for emissions test in diesel mode according to Annex 4<sup>2,\*,\*\*</sup>

Low speed (n<sub>lo</sub>) ..... rpm

High speed (n<sub>hi</sub>) ..... rpm



Idle speed	.....	rpm
Preferred speed	.....	rpm
$n_{95h}$	.....	rpm

\*\* In the case of Type 1B, Type 2B, and Type 3B of dual-fuel engines (types as defined in Annex 15)."

Paragraph 5.2, amend to read:

"5.2. Declared values for power test according to Regulation No. 85 or declared values for power test in dual-fuel mode according to Regulation No. 85\*\*"

Insert new paragraphs 5.2.6. to 5.2.6.5., to read:

"5.2.6. Declared values for power test in diesel mode according to Regulation 85\*\*"

5.2.6.1.	Idle speed	.....	rpm
5.2.6.2.	Speed at maximum power	.....	rpm
5.2.6.3.	Maximum power	.....	kW
5.2.6.4.	Speed at maximum torque	.....	rpm
5.2.6.5.	Maximum torque	.....	Nm"

..."

Annex 2A, Addendum to Type-approval Communication No ... concerning the type-approval of an engine type or family as a separate technical unit with regard to exhaust emissions pursuant to Regulation No. 49, 06 series of amendments, and

Annex 2C, Addendum to Type-approval Communication No ... concerning the type-approval of a vehicle type with regard to the emission of pollutants pursuant to Regulation No. 49, 06 series of amendments,

Paragraph 1.1.5., amend to read:

"1.1.5. Category of engine: Diesel/Petrol/LPG/NG-H/NG-L/NG-HL/Ethanol (ED95)/Ethanol (E85)/dual-fuel<sup>1</sup>"

Insert new paragraph 1.1.5.1., to read (including a new footnote \*):

"1.1.5.1. Type of dual-fuel engine: Type 1A/Type 1B/Type 2A/Type 2B/Type 3B<sup>1,\*</sup>

\* In case of a dual-fuel engine or vehicle (types as defined in Annex 15)."

Paragraph 1.4., amend to read:

"1.4. Emission levels of the engine/parent engine<sup>1</sup>  
Deterioration Factor (DF): calculated/fixed<sup>1</sup>  
Specify the DF values and the emissions on the WHSC (if applicable) and WHTC tests in the table below  
In case of engines tested on different reference fuels, the tables shall be reproduced for each reference fuel tested.

In case of Type 1B and Type 2B dual-fuel engines, the tables shall be reproduced for each mode tested (dual-fuel and diesel modes)."

Paragraphs 1.4.1. and 1.4.2., amend to read (including a new footnote \*\*):

"1.4.1. WHSC test

Table 4  
**WHSC test**

WHSC test (if applicable)							
DF	CO	THC	NMHC**	NO <sub>x</sub>	PM Mass	NH <sub>3</sub>	PM Number
Mult/add <sup>1</sup>							
Emissions	CO (mg/kWh)	THC (mg/kWh)	NMHC** (mg/kWh)	NO <sub>x</sub> (mg/kWh)	PM Mass (mg/kWh)	NH <sub>3</sub> ppm	PM Number (#/kWh)
Test result							
Calculated with DF							
CO <sub>2</sub> emissions mass emission ** : .....g/kWh							
Fuel consumption ** : .....g/kWh							

1.4.2. WHTC Test

Table 5  
**WHTC Test**

WHTC test								
DF	CO	THC**	NMHC**	CH <sub>4</sub> **	NO <sub>x</sub>	PM Mass	NH <sub>3</sub>	PM Number
Mult/add <sup>1</sup>								
Emissions	CO (mg/kWh)	THC** (mg/kWh)	NMHC** (mg/kWh)	CH <sub>4</sub> ** (mg/kWh)	NO <sub>x</sub> (mg/kWh)	PM Mass (mg/kWh)	NH <sub>3</sub> ppm	PM Number (#/kWh)
Cold start								
Hot start w/o regeneration								
Hot start with regeneration <sup>(1)</sup>								
k <sub>r,u</sub> <sub>1</sub> (mult/add)								
k <sub>r,d</sub> <sub>1</sub> (mult/add)								
Weighted test result								
Final test result with DF								
CO <sub>2</sub> emissions mass emission ** : .....g/kWh								
Fuel consumption ** : .....g/kWh								

\*\* When required by this Regulation."

Annex 3,

Table 2, amend to read:

"Table 2

**Engine type codes for approval marks**

Engine type	Code
Diesel fuelled CI engine	D
Ethanol (ED95) fuelled CI engine	ED
Ethanol (E85) fuelled PI engine	E85
Petrol fuelled PI engine	P
LPG fuelled PI engine	Q
Natural gas fuelled PI engine	See paragraph 4.12.3.3.6. of this Regulation
Dual-fuel engines	See paragraph 4.12.3.3.7. of this Regulation

Annex 4,

Equation (13), amend to read:

$$k_{w,r} = \left( 1 - \frac{1,2442 \times H_a + 111,19 \times w_{ALF} \times \frac{q_{mf,i}}{q_{mad,i}}}{773,4 + 1,2442 \times H_a + \frac{q_{mf,i}}{q_{mad,i}} \times k_{f,w} \times 1000} \right) \times 1,008 \quad (13)''$$

Equation (14), amend to read:

$$k_{w,r} = \left( 1 - \frac{1,2442 \times H_a + 111,19 \times w_{ALF} \times \frac{q_{mf,i}}{q_{mad,i}}}{773,4 + 1,2442 \times H_a + \frac{q_{mf,i}}{q_{mad,i}} \times k_{f,w} \times 1000} \right) \left( 1 - \frac{P_r}{P_b} \right) \quad (14)''$$

Equation (15), amend to read:

$$k_{w,r} = \left( \frac{1}{1 + a \times 0,005 \times (c_{CO_2} + c_{CO})} - k_{w1} \right) \times 1,008 \quad (15)''$$

Equation (16), amend to read:

$$k_{f,w} = 0,055594 \times W_{ALF} + 0,0080021 \times W_{DEL} + 0,0070046 \times W_{EPS} \quad (16)''$$

Equation (17), amend to read:

$$k_{w1} = \frac{1,608 \times H_a}{1000 + (1,608 \times H_a)} \quad (17)''$$

Equation (18), amend to read:

$$k_{w,e} = \left[ \left( 1 - \frac{\alpha \times c_{CO_2w}}{200} \right) - k_{w2} \right] \times 1,008 \quad (18)''$$

Equation (19), amend to read:

$$" k_{w,e} = \left[ \left( \frac{1 - k_{w2}}{1 + \frac{\alpha \times c_{CO2d}}{200}} \right) \right] \times 1,008 \quad (19)"$$

Equation (20), amend to read:

$$" k_{w2} = \frac{1,608 \times \left[ H_d \times \left( 1 - \frac{1}{D} \right) + H_a \times \left( \frac{1}{D} \right) \right]}{1000 + \left\{ 1,608 \times \left[ H_d \times \left( 1 - \frac{1}{D} \right) + H_a \times \left( \frac{1}{D} \right) \right] \right\}} \quad (20)"$$

Equation (21), amend to read:

$$" k_{w,d} = (1 - k_{w3}) \times 1,008 \quad (21)"$$

Equation (22), amend to read:

$$" k_{w2} = \frac{1,608 \times H_d}{1000 + (1,608 \times H_d)} \quad (22)"$$

Annex 5,

The title of the first section, amend to read:

"Technical data on fuels for testing compression-ignition and dual-fuel engines"

The title of the second section, amend to read:

"Technical data on fuels for testing positive ignition and dual-fuel engines"

Insert new rows at the end of the second section, to read:

**"Type: Natural gas/Biomethane**

Characteristics	Units	Basis	Limits		Test method
			minimum	maximum	
...	...	...	...	...	...
<b>Reference fuel G<sub>20</sub></b>					
Composition:					
Methane	% mole	100	99	100	ISO 6974
Balance <sup>(1)</sup>	% mole	—	—	1	ISO 6974
N <sub>2</sub>	% mole				ISO 6974
Sulphur content	mg/m <sup>3</sup> (2)	—	—	10	ISO 6326-5
Wobbe Index (net)	MJ/m <sup>3</sup> (3)	48.2	47.2	49.2	
<sup>(1)</sup> Inerts (different from N <sub>2</sub> ) + C <sub>2</sub> + C <sub>2</sub> +. <sup>(2)</sup> Value to be determined at 293,2 K (20 °C) and 101,3 kPa. <sup>(3)</sup> Value to be determined at 273,2 K (0 °C) and 101,3 kPa.					

"

*Annex 7,*

*Paragraph 3.7.1.,* amend to read:

"3.7.1. The engines shall meet the respective emission limits for each pollutant, as given in paragraph 5.3. of this Regulation, after application of the deterioration factors to the test result as measured in accordance with Annex 4 ( $e_{\text{gas}}$ ,  $e_{\text{PM}}$ ). Depending on the type of deterioration factor (DF), the following provisions shall apply:

..."

*Annex 9B,*

*Paragraph 4.2.,* amend to read:

"4.2. Monitoring requirements

All emission-related components and systems included in an engine system shall be monitored by the OBD system in accordance with the requirements set in Appendix 3 and, in the case of dual-fuel engines or vehicles in section 7. of Annex 15. However, the OBD system is not required to use a unique monitor to detect each malfunction referred to in Appendix 3 and, in the case of dual-fuel engines or vehicles in section 7. of Annex 15.

..."

*Paragraph 4.2.1.,* amend to read:

"4.2.1. Selection of the monitoring technique

Approval authorities may approve a manufacturer's use of another type of monitoring technique than the one mentioned in Appendix 3 or, in the case of dual-fuel engines or vehicles in section 7. of Annex 15. The chosen type of monitoring shall be shown by the manufacturer, to be robust, timely and efficient (i.e. through technical considerations, test results, previous agreements, etc.).

In case a system and/or component is not covered by Appendix 3 or, in the case of dual-fuel engines or vehicles in section 7. of Annex 15, the manufacturer shall submit for approval to the Type Approval Authority an approach to monitoring. The Type Approval Authority will approve the chosen type of monitoring and monitoring technique (i.e. emission threshold monitoring, performance monitoring, total functional failure monitoring, or component monitoring) if it has been shown by the manufacturer by reference to those detailed in Appendix 3 or, in the case of dual-fuel engines or vehicles in section 7. of Annex 15, to be robust, timely and efficient (i.e. through either technical considerations, test results, previous agreements, etc.)."

*Paragraph 6.3.2.1.2.,* amend to read:

"6.3.2.1.2. Performance monitoring

At the request of the manufacturer and with the agreement of the Type Approval Authority, in the case of performance monitoring, the OTL may be exceeded by more than 20 per cent. Such request shall be justified on a case by case basis.

In the case when the performance monitoring of an abnormality of the gaseous fuel consumption of a dual-fuel engine or vehicle is required by Annex 15, a deteriorated component is qualified without reference to the OTL."

Appendix 4, section with the title "Item 1 to the technical compliance report (example)", first line of text, amend to read:

"Information concerning the OBD system"

Appendix 4, section with the title "Item 2 to the technical compliance report (example)", paragraph 2, the first row of the table, amend to read:

"

<p><i>Monitoring</i></p> <p>The monitors comply with the requirements of section 4.2. of this annex:</p>	<p>YES / NO</p>
--	-----------------

"

Insert a new Annex 15, to read (including footnotes):

## "Annex 15

### Technical requirements for diesel-gas dual-fuel engines and vehicles

1. Scope
 

This annex shall apply to dual-fuel engines and dual-fuel vehicles.
2. Definitions and abbreviations
  - 2.1. "Gas Energy Ratio (GER)" means in case of a dual-fuel engine the ratio (expressed as a percentage) of the energy content of the gaseous fuel<sup>1</sup> over the energy content of both fuels (diesel and gaseous).
  - 2.2. "Average gas ratio" means the average gas energy ratio calculated over a specific operating sequence.
  - 2.3. "Heavy-Duty Dual-Fuel (HDDF) Type 1A engine" means a dual-fuel engine that operates over the hot part of the WHTC test-cycle with an average gas ratio that is not lower than 90 per cent ( $GER_{WHTC} \geq 90 \%$ ), and that does not idle using exclusively diesel fuel, and that has no diesel mode.
  - 2.4. "Heavy-Duty Dual-Fuel (HDDF) Type 1B engine" means a Dual-Fuel engine that operates over the hot part of the WHTC test-cycle with an average gas ratio that is not lower than 90 per cent ( $GER_{WHTC} \geq 90 \%$ ), and that does not idle using exclusively diesel fuel in dual-fuel mode, and that has a diesel mode.
  - 2.5. "Heavy-Duty Dual-Fuel (HDDF) Type 2A engine" means a Dual-Fuel engine that operates over the hot part of the WHTC test-cycle with an average gas

<sup>1</sup> Based on the lower heating value.

ratio between 10 per cent and 90 per cent ( $10 \% < GER_{WHTC} < 90 \%$ ) and that has no diesel mode or that operates over the hot part of the WHTC test-cycle with an average gas ratio that is not lower than 90 per cent ( $GER_{WHTC} \geq 90 \%$ ), but that idles using exclusively diesel fuel, and that has no diesel mode.

2.6. "Heavy-Duty Dual-Fuel (HDDF) Type 2B engine" means a Dual-Fuel engine that operates over the hot part of the WHTC test-cycle with an average gas ratio between 10 per cent and 90 per cent ( $10 \% < GER_{WHTC} < 90 \%$ ) and that has a diesel mode or that operates over the hot part of the WHTC test-cycle with an average gas ratio that is not lower than 90 per cent ( $GER_{WHTC} \geq 90 \%$ ), but that can idle using exclusively diesel fuel in dual-fuel mode, and that has a diesel mode.

2.7. "Heavy-Duty Dual-Fuel (HDDF) Type 3B engine"<sup>2</sup> means a dual-fuel engine that operates over the hot part of the WHTC test-cycle with an average gas ratio that does not exceed 10 per cent ( $GER_{WHTC} \leq 10 \%$ ) and that has a diesel mode.

3. Dual-fuel specific additional approval requirements

3.1. Dual-fuel-engine family

3.1.1. Criteria for belonging to a dual-fuel engine family

All engines within a dual-fuel engine family shall belong to the same type of dual-fuel engines defined in section 2<sup>3</sup>, and operate with the same types of fuel or when appropriate with fuels declared according to this Regulation as being of the same range(s).

All engines within a dual-fuel engine family shall meet the criteria defined by this Regulation for belonging to a compression ignition engine family.

The difference between the highest and the lowest  $GER_{WHTC}$  (i.e. the highest  $GER_{WHTC}$  minus the lowest  $GER_{WHTC}$ ) within a dual-fuel engine family shall not exceed 30 per cent.

3.1.2. Selection of the parent engine

The parent engine of a dual-fuel engine family shall be selected according to the criteria defined by this Regulation for selecting the parent engine of a compression ignition engine family.

4. General requirements

4.1. Operating modes of dual-fuel engines and vehicles

4.1.1. Conditions for a dual-fuel engine to operate in diesel mode

A dual-fuel engine may only operate in diesel mode if, when operating in diesel mode, it has been certified according to all the requirements of this Regulation concerning diesel engines.

When a dual-fuel engine is developed from an already certified diesel engine, then re-certification is required in the diesel mode.

---

<sup>2</sup> HDDF Type 3A are neither defined nor allowed by this Regulation.

<sup>3</sup> For example HDDF Type 1A, or HDDF Type 2B, etc.

- 4.1.2. Conditions for a HDDF engine to idle using diesel fuel exclusively
- 4.1.2.1. HDDF Type 1A engines shall not idle using diesel fuel exclusively except under the conditions defined in section 4.1.3. for warm-up and start.
- 4.1.2.2. HDDF Type 1B engines shall not idle using diesel fuel exclusively in dual-fuel mode.
- 4.1.2.3. HDDF Types 2A, 2B and 3B engines may idle using diesel fuel exclusively.
- 4.1.3. Conditions for a HDDF engine to warm-up or start using diesel fuel solely
- 4.1.3.1. A Type 1B, Type 2B, or Type 3B dual-fuel engine may warm-up or start using diesel fuel solely. However, in that case, it shall operate in diesel mode.
- 4.1.3.2. A Type 1A or Type 2A dual-fuel engine may warm-up or start using diesel fuel solely. However, in that case, the strategy shall be declared as an AES and the following additional requirements shall be met:
- 4.1.3.2.1. The strategy shall cease to be active when the coolant temperature has reached a temperature of 343 K (70 °C), or within 15 minutes after it has been activated, whichever occurs first; and
- 4.1.3.2.2. The service mode shall be activated while the strategy is active.
- 4.2. Service mode
- 4.2.1. Conditions for dual-fuel engines and vehicles to operate in service mode
- When its engine is operating in service mode, a dual-fuel vehicle is subject to an operability restriction and is temporarily exempted from complying with the requirements related to exhaust emissions, OBD and NO<sub>x</sub> control described in this Regulation.
- 4.2.2. Operability restriction in service mode
- The operability restriction applicable to dual-fuel vehicles when they operate in service mode is the one activated by the "severe inducement system" specified in Annex 11.
- The operability restriction shall not be deactivated by either the activation or deactivation of the warning and inducement systems specified in Annex 11.
- The activation and the deactivation of the service mode shall not activate or deactivate the warning and inducement systems specified in Annex 11.
- Illustrations of the operability restriction requirements are given in Appendix 2.
- 4.2.2.1. Activation of the operability restriction
- The operability restriction shall be automatically activated when the service mode is activated.
- In the case where the service mode is activated according to paragraph 4.2.3. because of a malfunction of the gas supply system or because of an abnormality of gas consumption, the operability restriction shall become active after the next time the vehicle is stationary or within 30 minutes operating time after the service mode is activated, whichever comes first.
- In the case where the service mode is activated because of an empty gas tank, the operability restriction shall become active as soon as the service mode is activated.



- 4.2.2.2. Deactivation of the operability restriction  
The operability restriction system shall be deactivated when the vehicle no longer operates in service mode.
- 4.2.3. Unavailability of gaseous fuel when operating in a dual-fuel mode  
In order to permit the vehicle to keep moving and eventually to move out of the main-stream traffic, upon detection of an empty gaseous fuel tank, or of a malfunctioning gas supply system according to paragraph 7.2., or of an abnormality of gas consumption in dual-fuel mode according to paragraph 7.3.:
- (a) Dual-fuel engines of Types 1A and 2A shall activate the service mode;
  - (b) Dual-fuel engines of Types 1B, 2B and 3B shall operate in diesel mode.
- 4.2.3.1. Unavailability of gaseous fuel – empty gaseous fuel tank  
In the case of an empty gaseous fuel tank, the service mode or, as appropriate according to paragraph 4.2.3., the diesel mode shall be activated as soon as the engine system has detected that the tank is empty.  
When the gas availability in the tank again reaches the level that justified the activation of the empty tank warning system specified in paragraph 4.3.2., the service mode may be deactivated, or, when appropriate, the dual-fuel mode may be reactivated.
- 4.2.3.2. Unavailability of gaseous fuel – malfunctioning gas supply  
In the case of a malfunctioning gas supply system according to paragraph 7.2., the service mode or, as appropriate according to paragraph 4.2.3., the diesel mode shall be activated when the DTC relevant to that malfunction has the confirmed and active status.  
As soon as the diagnostic system concludes that the malfunction is no longer present or when the information, including DTCs relative to the failures, justifying its activation is erased by a scan tool, the service mode may be deactivated, or, when appropriate, the dual-fuel mode may be reactivated.
- 4.2.3.2.1. If the counter specified in paragraph 4.4. and associated with a malfunctioning gas supply system is not at zero, and is consequently indicating that the monitor has detected a situation when the malfunction may have occurred for a second or subsequent time, the service mode or, as appropriate, the diesel mode shall be activated when the DTC has the status "potential".
- 4.2.3.3. Unavailability of gaseous fuel – abnormality of gas consumption  
In case of an abnormality of gas consumption in dual-fuel mode according to paragraph 7.3., the service mode or, as appropriate according to paragraph 4.2.3., the diesel mode shall be activated when the DTC relevant to that malfunction has reached the potential status.  
As soon as the diagnostic system concludes that the malfunction is no longer present or when the information, including DTCs relative to the failures, justifying its activation is erased by a scan tool, the service mode may be deactivated, or, when appropriate, the dual-fuel mode may be reactivated.

- 4.3. Dual-fuel indicators
- 4.3.1. Dual-fuel operating mode indicator
- Dual-fuel engines and vehicles shall provide to the driver a visual indication of the mode under which the engine operates (dual-fuel mode, diesel mode, or service mode).
- The characteristics and the location of this indicator are left to the decision of the manufacturer and may be part of an already existing visual indication system.
- This indicator may be completed by a message display. The system used for displaying the messages referred to in this paragraph may be the same as the ones used for OBD, correct operation of NO<sub>x</sub> control measures, or other maintenance purposes.
- The visual element of the dual-fuel operating mode indicator shall not be the same as the one used for the purposes of OBD (that is, the MI – malfunction indicator), for the purpose of ensuring the correct operation of NO<sub>x</sub> control measures, or for other engine maintenance purposes.
- Safety alerts always have display priority over the operating mode indication.
- 4.3.1.1. The dual-fuel mode indicator shall be set to service mode as soon as the service mode is activated (i.e. before it becomes actually active) and the indication shall remain as long as the service mode is active.
- 4.3.1.2. The dual-fuel mode indicator shall be set for at least one minute on dual-fuel mode or diesel mode as soon as the engine operates on dual-fuel or on diesel mode. This indication is required at key-on for at least 1 minute. The indication shall also be given upon driver's request.
- 4.3.2. Empty gaseous fuel tank warning system (dual-fuel warning system)
- A dual-fuel vehicle shall be equipped with a dual-fuel warning system that alerts the driver that the gaseous fuel tank will soon become empty.
- The dual-fuel warning system shall remain active until the tank is refuelled to a level above which the warning system is activated.
- The dual-fuel warning system may be temporarily interrupted by other warning signals providing important safety-related messages.
- It shall not be possible to turn off the dual-fuel warning system by means of a scan-tool as long as the cause of the warning activation has not been rectified.
- 4.3.2.1. Characteristics of the dual-fuel warning system
- The dual-fuel warning system shall consist of a visual alert system (icon, pictogram, etc.) left to the choice of the manufacturer.
- It may include, at the choice of the manufacturer, an audible component. In that case, the cancelling of that component by the driver is permitted.
- The visual element of the dual-fuel warning system shall not be the same as the one used for the OBD system (that is, the MI – malfunction indicator), for the purpose of ensuring the correct operation of NO<sub>x</sub> control measures, or for other engine maintenance purposes.

In addition the dual-fuel warning system may display short messages, including messages indicating clearly the remaining distance or time before the activation of the operability restriction.

The system used for displaying the messages referred to in this paragraph may be the same as the one used for displaying additional OBD messages, messages related to correct operation of NO<sub>x</sub> control measures, or messages for other maintenance purposes.

A facility to permit the driver to dim the visual alarms provided by the warning system may be provided on vehicles for use by the rescue services or on vehicles designed and constructed for use by the armed services, civil defense, fire services and forces responsible for maintaining public order.

4.4. Malfunctioning gas supply counter

The system shall contain a counting system to record the number of hours during which the engine has been operated while the system has detected a malfunctioning gas supply system according to paragraph 7.2.

4.4.1. The activation and deactivation criteria and mechanisms of the counter shall comply with the specifications of Appendix 2.

4.4.2. It is not required to have a counter as specified in paragraph 4.4., when the manufacturer can demonstrate to the Type Approval Authority (e.g. by means of a strategy description, experimental elements, etc...) that the dual-fuel engine automatically switches to diesel mode in case malfunction is detected.

4.5. Demonstration of the dual-fuel indicators and operability restriction

As part of the application for type-approval under this Regulation, the manufacturer shall demonstrate the operation of dual-fuel indicators and of the operability restriction in accordance with the provisions of Appendix 3.

4.6. Communicated torque

4.6.1. Communicated torque when a dual-fuel engine operates in dual-fuel mode

When a dual-fuel engine operates in dual-fuel mode:

- (a) The reference torque curve retrievable according to the requirements related to data stream information specified in Annex 9B and referred to by Annex 8 shall be the one obtained according to Annex 4 when that engine is tested on an engine test bench in the dual-fuel mode;
- (b) The recorded actual torques (indicated torque and friction torque) shall be the result of the dual-fuel combustion and not the one obtained when operating with diesel fuel exclusively.

4.6.2. Communicated torque when a dual-fuel engine operates in diesel mode

When a dual-fuel engine operates in diesel mode, the reference torque curve retrievable according to the requirements related to data stream information specified in Annex 9B and referred to by Annex 8 shall be the one obtained according to Annex 4 when the engine is tested on an engine test bench in diesel mode.

- 4.7. Requirements to limit Off-Cycle Emissions (OCE) and in-use emissions
- Dual-fuel engines shall be subject to the requirements of Annex 10, whether operating in dual-fuel mode or in the case of Type 1B, Type 2B, and Type 3B in diesel mode.
- 4.7.1. PEMS tests at certification
- The PEMS demonstration test at type-approval required in Annex 10 shall be performed by testing the parent engine of a dual-fuel engine family when operating in dual-fuel mode.
- 4.7.1.1. In the case of Type 1B, Type 2B and Type 3B dual-fuel engines, an additional PEMS test shall be performed in diesel mode on the same engine and vehicle immediately after or before the PEMS demonstration test performed in dual-fuel mode.
- In that case, certification can only be granted if both the PEMS demonstration test in dual-fuel mode and the PEMS demonstration test in diesel mode have concluded to a pass.
- 4.7.2. Additional requirements
- 4.7.2.1. Adaptive strategies of a dual-fuel engine are allowed, provided that:
- (a) The engine always remains in the HDDDF type (that is Type 1A, Type 2B, etc.) that has been declared for type-approval; and
  - (b) In case of a Type 2 engine, the resulting difference between the highest and the lowest  $GER_{WHTC}$  within the family shall never exceed the percentage specified in paragraph 3.1.1.; and
  - (c) These strategies are declared and satisfy the requirements of Annex 10.
5. Performance requirements
- 5.1. Emission limits applicable to HDDDF Type 1A and Type 1B engines
- 5.1.1. The emission limits applicable to HDDDF Type 1A engines and HDDDF Type 1B engines operating in dual-fuel mode are those defined for PI engines in paragraph 5.3. of this Regulation.
- 5.1.2. The emission limits applicable to HDDDF Type 1B engines operating in diesel mode are those defined for CI engines in paragraph 5.3. of this Regulation.
- 5.2. Emission limits applicable to HDDDF Type 2A and Type 2B engines
- 5.2.1. Emission limits applicable over the WHSC test-cycle
- 5.2.1.1. For HDDDF Type 2A and Type 2B engines, the exhaust emission limits (incl. the PM number limit) over the WHSC test-cycle applicable to HDDDF Type 2A engines and HDDDF Type 2B engines operating in dual-fuel mode are those applicable to CI engines over the WHSC test-cycle and defined in the table of paragraph 5.3. of this Regulation.
- 5.2.1.2. The emission limits (incl. the PM number limit) over the WHSC test-cycle applicable to HDDDF Type 2B engines operating in diesel mode are those defined for CI engines in paragraph 5.3. of this Regulation.
- 5.2.2. Emission limits applicable over the WHTC test-cycle

- 5.2.2.1. Emission limits for CO, NO<sub>x</sub>, NH<sub>3</sub> and PM mass
- The CO, NO<sub>x</sub>, NH<sub>3</sub> and PM mass emission limits over the WHTC test-cycle applicable to HDDF Type 2A engines and HDDF Type 2B engines operating in dual-fuel mode are those applicable to both CI and PI engines over the WHTC test-cycle and defined in paragraph 5.3. of this Regulation.
- 5.2.2.2. Emission limits for Hydrocarbons
- 5.2.2.2.1. NG engines
- The THC, NMHC and CH<sub>4</sub> emission limits over the WHTC test-cycle applicable to HDDF Type 2A engines and HDDF Type 2B engines operating with Natural Gas in dual-fuel mode are calculated from those applicable to CI and PI engines over the WHTC test-cycle and defined in paragraph 5.3. of this Regulation. The calculation procedure is specified in paragraph 5.3. of this annex.
- 5.2.2.2.2. LPG engines
- The THC emission limits over the WHTC test-cycle applicable to HDDF Type 2A engines and HDDF Type 2B engines operating with LPG in dual-fuel mode are those applicable to CI engines over the WHTC test-cycle and defined in paragraph 5.3. of this Regulation.
- 5.2.2.3. Emission limits for PM number
- 5.2.2.3.1. The PM number limit over the WHTC test-cycle applicable to HDDF Type 2A engines and HDDF Type 2B engines operating in dual-fuel mode are those applicable to CI engines over the WHTC test-cycle and defined in paragraph 5.3. of this Regulation. In the case a PM number limit applicable to PI engines over the WHTC test-cycle would be defined in paragraph 5.3. of this Regulation, then the requirements of paragraph 5.2.4. shall apply for calculating the limit applicable to HDDF Type 2A engines and HDDF Type 2B engines over that cycle.
- 5.2.2.3.2. The emission limits (incl. the PM number limit) over the WHTC test-cycle applicable to HDDF Type 2B engines operating in diesel mode are those defined for CI engines in paragraph 5.3. of this Regulation.
- 5.2.3. Hydrocarbon limits (in mg/kWh) applicable to HDDF Type 2A engines and to HDDF Type 2B engines operating in dual-fuel mode during the WHTC test cycle.
- The following calculation procedure applies for HDDF Type2A and HDDF Type 2B engines tested in the WHTC cycle while operating in dual-fuel mode:
- Calculate the average gas ratio GER<sub>WHTC</sub> over the hot part of the WHTC test cycle.
- Calculate a corresponding THC<sub>GER</sub> in mg/kWh using the following formula:
- $$\text{THC}_{\text{GER}} = \text{NMHC}_{\text{PI}} + (\text{CH}_4_{\text{PI}} * \text{GER}_{\text{WHTC}})$$
- Determine the applicable THC limit in mg/kWh using the following method:
- If  $\text{THC}_{\text{GER}} \leq \text{CH}_4_{\text{PI}}$ , then
- THC limit value = THC<sub>GER</sub>; and
  - No applicable CH<sub>4</sub> and NMHC limit value

If  $THC_{GER} > CH4_{PI}$ , then

- (a) No applicable THC limit value; and
- (b) Both the  $NMHC_{PI}$  and  $CH4_{PI}$  limit values are applicable.

In this procedure:

$NMHC_{PI}$  is the NMHC emission limit over the WHTC test-cycle and made applicable to PI engine by paragraph 5.3. of this Regulation;

$CH4_{PI}$  is the  $CH_4$  emission limit over the WHTC test-cycle and applicable to PI engine by paragraph 5.3. of this Regulation.

Figure 1  
**Illustration of the HC limits in the case of a HDDF Type2 engine operating in dual-fuel mode during the WHTC cycle (natural gas dual-fuel engines)**

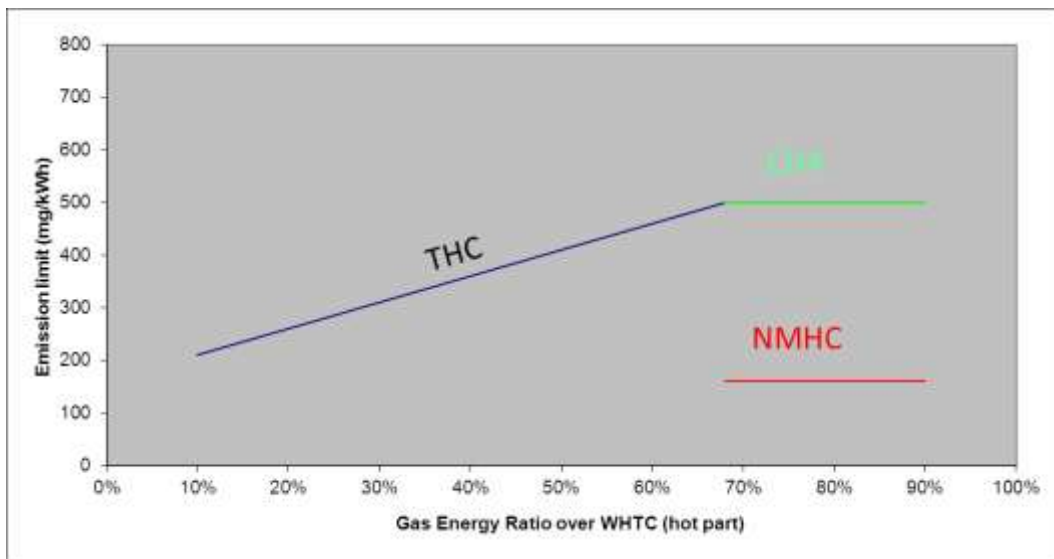

5.2.4. PM number limit (in #/kWh) applicable to HDDF Type 2A engines and to HDDF Type 2B engines operating in dual-fuel mode during the WHTC test cycle.

In the case a PM number limit applicable to PI engines over the WHTC test-cycle would be defined in paragraph 5.3. of this Regulation, the following calculation procedure shall apply to HDDF Type 1A engines, to HDDF Type 1B engines, to HDDF Type 2A engines, to HDDF Type 2A and to HDDF Type 2B engines tested in the WHTC cycle while operating in dual-fuel mode:

Calculate the average gas ratio  $GER_{WHTC}$  over the hot part of the WHTC test cycle, then

Calculate the PM number limit values  $PN_{limit_{WHTC}}$  in #/kWh applicable over the WHTC test-cycle using the following formula (linear interpolation between the CI and PI PM number limit values):

$$PN_{limit_{WHTC}} = PN_{limit_{CI/WHTC}} + (PN_{limit_{PI/WHTC}} - PN_{limit_{CI/WHTC}}) * GER_{WHTC}$$

where:

PN limit<sub>PI/WHTC</sub> is the PM number limit applicable to PI engines over the WHTC test cycle;

PN limit<sub>CI/WHTC</sub> is the PM number limit applicable to CI engines over the WHTC test cycle.

Figure 2

**Illustration of the PN limits in the case of a HDDF Type 2 engine operating in dual-fuel mode during the WHTC cycle**

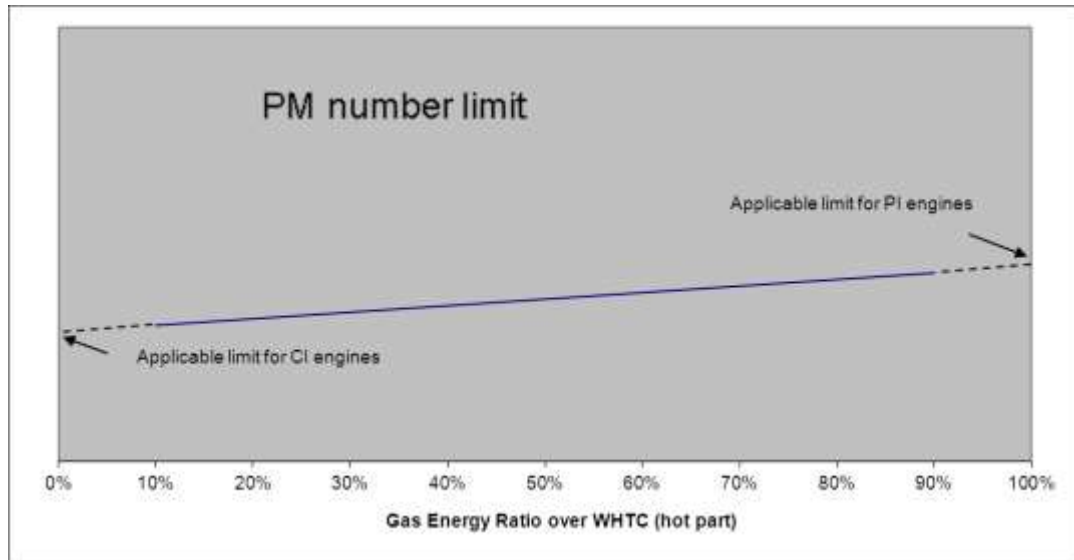

5.3. Emission limits applicable to HDDF Type 3B engines operating in dual-fuel mode

The emissions limits applicable to HDDF Type 3B engines whether operating in dual-fuel mode or in diesel mode are the exhaust emission limits applicable to CI engines.

5.4. Conformity factors

Principally, the emission limit applicable for applying the conformity factor used when performing a PEMS test, whether a PEMS test at certification or a PEMS test when checking and demonstrating the conformity of in-service engines and vehicles, shall be determined on the basis of the actual GER calculated from the fuel consumption measured over the on-road test.

However, in absence of a robust way to measure the gas or the diesel fuel consumption, the manufacturer is allowed to use the GER<sub>WHTC</sub> determined on the hot part of the WHTC.

6. Demonstration requirements

6.1. Dual-fuel engines shall be subject to the laboratory tests specified in Table 1.

Table 1  
**Laboratory tests to be performed by a dual-fuel engine**

	<i>Type 1A</i>	<i>Type 1B</i>	<i>Type 2A</i>	<i>Type 2B</i>	<i>Type 3B</i>
WHTC	NMHC; CH <sub>4</sub> ; CO; NO <sub>x</sub> ; PM; PN; NH <sub>3</sub>	<u>Dual-fuel mode:</u> NMHC; CH <sub>4</sub> ; CO; NO <sub>x</sub> ; PM; PN; NH <sub>3</sub> <u>Diesel mode:</u> THC; CO; NO <sub>x</sub> ; PM; PN; NH <sub>3</sub>	THC; NMHC; CH <sub>4</sub> ; CO; NO <sub>x</sub> ; PM; PN; NH <sub>3</sub>	<u>Dual-fuel mode:</u> THC; NMHC; CH <sub>4</sub> ; CO; NO <sub>x</sub> ; PM; PN; NH <sub>3</sub> <u>Diesel mode:</u> THC; CO; NO <sub>x</sub> ; PM; PN; NH <sub>3</sub>	THC; CO; NO <sub>x</sub> ; PM; PN; NH <sub>3</sub>
WHSC	no test	<u>Dual-fuel mode:</u> no test <u>Diesel mode:</u> THC; CO; NO <sub>x</sub> ; PM; PN; NH <sub>3</sub>	NMHC; CO; NO <sub>x</sub> ; PM; PN; NH <sub>3</sub>	<u>Dual-fuel mode:</u> NMHC; CO; NO <sub>x</sub> ; PM; PN; NH <sub>3</sub> <u>Diesel mode:</u> THC; CO; NO <sub>x</sub> ; PM; PN; NH <sub>3</sub>	THC; CO; NO <sub>x</sub> ; PM; PN; NH <sub>3</sub>
WNTE laboratory test	no test	<u>Dual-fuel mode:</u> no test <u>Diesel mode:</u> THC; CO; NO <sub>x</sub> ; PM	[HC]; CO; NO <sub>x</sub> ; PM	<u>Dual-fuel mode:</u> [HC]; CO; NO <sub>x</sub> ; PM <u>Diesel mode:</u> THC; CO; NO <sub>x</sub> ; PM	THC; CO; NO <sub>x</sub> ; PM

6.2. Demonstrations in case of installation of type-approved HDDF engines

In addition to the requirements of this Regulation related to the installation of an engine that is type-approved as separate technical unit, a demonstration of the correct installation on a vehicle of a dual-fuel engine shall be done on the basis of appropriate elements of design, results of verification tests, etc. It shall address the conformity of the following elements to the requirements of this annex:

- (a) The dual-fuel indicators and warnings as specified in this annex (pictogram, activation schemes, etc.);
- (b) The fuel storage system;
- (c) The performance of the vehicle in service mode.

Correct indicator illumination and warning system activation will be checked. But any check shall not force dismantling the engine system (e.g. an electric disconnection may be selected).

6.3. Demonstration requirements in case of a Type 2 engine

The manufacturer shall present the Type Approval Authority with evidence showing that the GER<sub>WHTC</sub> span of all members of the dual-fuel engine family remains within the percentage specified in paragraph 3.1.1.



- (for example, through algorithms, functional analyses, calculations, simulations, results of previous tests, etc.).
- 6.4. Additional demonstration requirements in case of a universal fuel range type-approval
- On request of the manufacturer and with approval of the Type Approval Authority, a maximum of two times the last 10 minutes of the WHTC may be added to the adaptation run between the demonstration tests.
- 6.5. Requirements for demonstrating the durability of a dual-fuel engine
- Provisions of Annex 7 shall apply.
7. OBD requirements
- 7.1. General OBD requirements
- All dual-fuel engines and vehicles shall comply with the requirements specified in Annex 9A and applicable to diesel engines, independent whether operating in dual-fuel or diesel mode.
- In case a dual-fuel engine system is equipped with oxygen sensor(s), the requirements applicable to gas engines in item 13. in Appendix 3 of Annex 9B shall apply.
- In case a dual-fuel engine system is equipped with a 3-way catalyst, the requirements applicable to gas engines in items 7., 10., and 15. in Appendix 3 of Annex 9B shall apply.
- 7.1.1. Additional general OBD requirements in case of Type 1B, Type 2B and Type 3B dual-fuel engines and vehicles.
- 7.1.1.1. In the case of malfunctions the detection of which does not depend on the operation mode of the engine, the mechanisms specified in Annex 9B that are associated with the DTC status shall not depend on the operation mode of the engine (for example, if a DTC reached the potential status in dual-fuel mode, it will get the confirmed and active status the next time the failure is detected, even in diesel mode).
- 7.1.1.2. In the case of malfunctions where the detection depends on the operation mode of the engine, DTCs shall not get a previously active status in a different mode than the mode in which they reached the confirmed and active status.
- 7.1.1.3. A change of the mode of operation (dual-fuel to diesel or vice-versa) shall not stop nor reset the OBD mechanisms (counters, etc.). However, in the case of failures the detection of which depends on the actual operation mode, the counters associated with these malfunctions may, at the request of the manufacturer and upon approval of the Type Approval Authority:
- (a) Halt and, when applicable, hold their present value when the operation mode changes;
  - (b) Restart and, when applicable, continue counting from the point at which they have been held when the operation mode changes back to the other operation mode.
- 7.1.1.4. A possible influence of the mode of operation on the malfunction detection shall not be used to extend the time until an operability restriction becomes active.

- 7.1.1.5. In case of a Type 1B, Type 2B, or Type 3B dual-fuel engine, the manufacturer shall specify which malfunctions are operation mode dependent. This information shall be included in the information package required in paragraph 8.1. (a) of Annex 9B. The justification for operation mode dependency shall be included in the information package required in paragraph 8.1. (b) of Annex 9B.
- 7.1.1.5. The following piece of information shall be added to table 1 in Appendix 5 of Annex 9B.

	<i>Freeze frame</i>	<i>Data stream</i>
In case of Type 1B, Type 2B and Type 3B dual-fuel engines, operation mode of the Dual-fuel Engine (dual-fuel or diesel)	x	x

- 7.2. Monitoring of the gas supply system
- HDDF engines and vehicles shall monitor the gas supply system within the engine system (incl. the signals coming from outside of the engine system) according to the specifications of item 1. in Appendix 3 to Annex 9B – component monitoring.
- 7.3. Monitoring of the gaseous fuel consumption
- Dual-fuel vehicles shall include a means of determining gas fuel consumption and providing off-board access to consumption information. Abnormality of the gaseous fuel consumption (e.g. a deviation of 50 per cent of the normal gaseous fuel consumption) shall be monitored – performance monitoring.
- The monitor for insufficient gaseous fuel consumption shall run continuously whenever in dual-fuel mode, however the maximum detection period is 48 hours of operation in dual-fuel mode.
- The monitor shall not be subject to the "IUPR" requirements.
- 7.4. OBD deficiencies
- The deficiency rules specified in Annex 9B and applicable to diesel engines shall apply to dual-fuel engines.
- A deficiency that is present both in diesel mode and in dual-fuel mode shall not be counted for each mode separately.
- 7.5. Erasing of failure information by means of a scan-tool
- 7.5.1. Erasing of information by means of a scan tool, including DTCs relative to the malfunctions considered in this annex shall be performed in accordance with Annex 9B.
- 7.5.2. The erasing of failure information shall only be possible under "engine-off" conditions.
- 7.5.3. When failure information related to the gas supply system as specified in paragraph 7.2., including the DTC, is erased, the counter associated with this failure shall not be erased.

8. Requirements to ensure the correct operation of NO<sub>x</sub> control measures
- 8.1. Annex 11 (on correct operation of NO<sub>x</sub> control measures) shall apply to HDDF engines and vehicles, whether operating in dual-fuel or diesel mode.
- 8.2. Additional general OBD requirements in case of Type 1B, Type 2B and Type 3B dual-fuel engines and vehicles
- 8.2.1. In case of HDDF Type 1B, Type 2B and Type 3B, the torque considered to apply low level inducement defined in Annex 11 shall be the lowest of the torques obtained in diesel mode and in dual-fuel mode.
- 8.2.2. The requirements of section 7.1.1. concerning additional general OBD requirements in case of Type 1B, Type 2B and Type 3B dual-fuel engines and vehicles shall also apply to the diagnostic system related to the correct operation of NO<sub>x</sub> control systems.
- In particular:
- 8.2.2.1. A possible influence of the mode of operation on the malfunction detection shall not be used to extend the time until an operability restriction becomes active.
- 8.2.2.2. A change of the mode of operation (dual-fuel to diesel or vice-versa) shall not stop nor reset the mechanisms implemented to comply with the specification of Annex 11 (counters, etc.). However, in the case where one of these mechanisms (for example a diagnostic system) depends on the actual operation mode the counter associated with that mechanism may, at the request of the manufacturer and upon approval of the Type Approval Authority:
- (a) Halt and, when applicable, hold their present value when the operation mode changes;
- (b) Restart and, when applicable, continue counting from the point at which they have been held when the operation mode changes back to the other operation mode.
9. Conformity of in-service engines or vehicles/engines
- The conformity of in-service dual-fuel engines and vehicles shall be performed according to the requirements specified in Annex 8.
- The PEMS tests shall be performed in dual-fuel mode.
- 9.1. In the case of Type 1B, Type 2B and Type 3B dual-fuel engines, an additional PEMS test shall be performed in Diesel mode on the same engine and vehicle immediately after, or before, a PEMS test is performed in dual-fuel mode.
- In that case the pass or fail decision of the lot considered in the statistical procedure specified in Annex 8 shall be based on the following:
- (a) A pass decision is reached for an individual vehicle if both the PEMS test in dual-fuel mode and the PEMS test in Diesel mode have concluded a pass;
- (b) A fail decision is reached for an individual vehicle if either the PEMS test in dual-fuel mode or the PEMS test in Diesel mode has concluded a fail.

- 10. Additional test procedures
  - 10.1. Additional emission test procedure requirements for dual-fuel engines
    - 10.1.1. Dual-fuel engines shall comply with the requirements of Appendix 4 in addition to the requirements of this Regulation (incl. Annex 4) when performing an emission test.
  - 10.2. Additional PEMS emission test procedure requirements for dual-fuel engines
    - 10.2.1. When subject to a PEMS test, dual-fuel engines shall comply with the requirements of Appendix 5 in addition to the other PEMS requirements of this Regulation.
    - 10.2.2. Torque correction

When necessary, for instance because of variation of the gas fuel composition, the manufacturer may decide to correct the ECU torque signal. In that case the following requirements shall apply.
    - 10.2.2.1. Correction of the PEMS torque signal

The manufacturer shall submit to the Type Approval Authority a description of the relationship permitting to extrapolate the real torque from the torques obtained during emission testing with the 2 appropriate reference fuels and from the actually retrievable torque in the ECU.
    - 10.2.2.1.1. In the case when the torques obtained with the two reference fuels may be considered of the same magnitude (that is within the 7 per cent considered in paragraph 9.4.2.5. of this Regulation), the use of the corrected ECU value is not necessary,
    - 10.2.2.2. Torque value to consider in a PEMS test

For PEMS test (work based window) the corrected torque value shall result from that interpolation
    - 10.2.2.3. Conformity of the ECU torque-signal

The "Maximum torque" method specified in Appendix 4 to Annex 8 shall be understood as demonstrating that a point between the reference maximum torque curves obtained at a certain engine speed when testing with the 2 applicable reference fuels has been reached during vehicle testing.

The value of that point shall be estimated with the agreement of the Type Approval Authority on the basis of the actual fuel composition sampled as close as possible to the engine and the power curves obtained with each of the reference fuels during the emission certification test.
- 10.3. Additional dual-fuel specific CO<sub>2</sub> determination provisions

Section 3.1. of Annex 12 regarding the determination of CO<sub>2</sub> emissions in case of raw measurement is not applicable to dual-fuel engines. Instead the following provisions shall apply:

The measured test-averaged fuel consumption according to section 4.3. of Annex 12 shall be used as the base for calculating the test averaged CO<sub>2</sub> emissions.

The mass of each fuel consumed shall be used to determine, according to section A.6.4. of this annex, the molar hydrogen ratio and the mass fractions of the fuel mix in the test.

The total fuel mass shall be determined according to equations 23 and 24.

$$m_{\text{fuel,corr}} = m_{\text{fuel}} - \left( m_{\text{THC}} + \frac{A_{\text{C}} + \alpha \times A_{\text{H}}}{M_{\text{CO}}} \times m_{\text{CO}} + \frac{w_{\text{GAM}} + w_{\text{DEL}} + w_{\text{EPS}}}{100} \times m_{\text{fuel}} \right) \quad (23)$$

$$m_{\text{CO}_2,\text{fuel}} = \frac{M_{\text{CO}_2}}{A_{\text{C}} + \alpha \times A_{\text{H}}} \times m_{\text{fuel,corr}} \quad (24)$$

where:

$m_{\text{fuel,corr}}$	is the corrected fuel mass of both fuels, g/test
$m_{\text{fuel}}$	total fuel mass of both fuels, g/test
$m_{\text{THC}}$	mass of total hydrocarbon emissions in the exhaust gas, g/test
$m_{\text{CO}}$	mass of carbon monoxide emissions in the exhaust gas, g/test
$m_{\text{CO}_2,\text{fuel}}$	CO <sub>2</sub> mass emission coming from the fuel, g/test
$w_{\text{GAM}}$	sulphur content of the fuels, per cent mass
$w_{\text{DEL}}$	nitrogen content of the fuels, per cent mass
$w_{\text{EPS}}$	oxygen content of the fuels, per cent mass
$\alpha$	molar hydrogen ratio of the fuels (H/C)
$A_{\text{C}}$	is the Atomic mass of Carbon: 12,011 g/mol
$A_{\text{H}}$	is the Atomic mass of Hydrogen: 1,0079 g/mol
$M_{\text{CO}}$	is the Molecular mass of Carbon monoxide: 28,011 g/mol
$M_{\text{CO}_2}$	is the Molecular mass of Carbon dioxide : 44,01 g/mol

The CO<sub>2</sub> emission resulting from urea shall be calculated with equation 25:

$$m_{\text{CO}_2,\text{urea}} = \frac{c_{\text{urea}}}{100} \times \frac{M_{\text{CO}_2}}{M_{\text{CO(NH}_2)_2}} \times m_{\text{urea}} \quad (25)$$

where:

$m_{\text{CO}_2,\text{urea}}$	CO <sub>2</sub> mass emission resulting from urea, g/test
$c_{\text{urea}}$	urea concentration, per cent
$m_{\text{urea}}$	total urea mass consumption, g/test
$M_{\text{CO(NH}_2)_2}$	is the Molecular mass of urea: 60,056 g/mol

Then the total CO<sub>2</sub> emission shall be calculated with equation 26:

$$m_{\text{CO}_2} = m_{\text{CO}_2,\text{fuel}} + m_{\text{CO}_2,\text{urea}} \quad (26)$$

The brake specific CO<sub>2</sub> emissions,  $e_{CO_2}$  shall then be calculated according to section 3.3. of Annex 12.

11. Documentation requirements

11.1. Documentation for installing in a vehicle a type approved HDDF engine

The manufacturer of a dual-fuel engine type-approved as separate technical unit shall include in the installation documents of its engine system the appropriate requirements that will ensure that the vehicle, when used on the road or elsewhere as appropriate, will comply with the requirements of this annex. This documentation shall include but is not limited to:

- (a) The detailed technical requirements, including the provisions ensuring the compatibility with the OBD system of the engine system;
- (b) The verification procedure to be completed.

The existence and the adequacy of such installation requirements may be checked during the approval process of the engine system.

11.1.1. In the case when the vehicle manufacturer who applies for approval of the installation of the engine system on the vehicle is the same manufacturer who received the type-approval of the dual-fuel engine as a separate technical unit, the documentation specified in paragraph 11.2. is not required.

12. Appendices

Appendix 1 Types of HDDF engines and vehicles - illustration of the definitions and requirements

Appendix 2 Activation and deactivation mechanisms of the counter(s), warning system, operability restriction, service mode in case of dual fuel engines and vehicles- Description and illustrations

Appendix 3 HDDF dual-fuel indicator, warning system, operability restriction - Demonstration requirements

Appendix 4 Additional emission test procedure requirements for dual-fuel engines

Appendix 5 Additional PEMS emission test procedure requirements for dual-fuel engines

Appendix 6 Determination of molar component ratios and  $u_{gas}$  values for dual-fuel engines

## Annex 15 - Appendix 1

### Types of HDDF engines and vehicles - illustration of the definitions and main requirements

	$GER_{WHTC}^1$	Idle on diesel	Warm-up on diesel	Operation on diesel solely	Operation in absence of gas	Comments
Type 1A	$GER_{WHTC} \geq 90\%$	NOT Allowed	Allowed only on service mode	Allowed only on service mode	Service mode	
Type 1B	$GER_{WHTC} \geq 90\%$	Allowed only on Diesel mode	Allowed only on diesel mode	Allowed only on diesel & service modes	Diesel mode	
Type 2A	$10\% < GER_{WHTC} < 90\%$	Allowed	Allowed only on service mode	Allowed only on service mode	Service mode	$GER_{WHTC} \geq 90\%$ allowed
Type 2B	$10\% < GER_{WHTC} < 90\%$	Allowed	Allowed only on diesel mode	Allowed only on diesel & service modes	Diesel mode	$GER_{WHTC} \geq 90\%$ allowed
Type 3A	NEITHER DEFINED NOR ALLOWED					
Type 3B	$GER_{WHTC} \leq 10\%$	Allowed	Allowed only on diesel mode	Allowed only on diesel & service modes	Diesel mode	

<sup>1</sup> This average Gas Energy Ratio  $GER_{WHTC}$  is calculated over the hot part of the WHTC test-cycle

## Annex 15 - Appendix 2

### **Activation and deactivation mechanisms of the counter(s), warning system, operability restriction, service mode in case of dual-fuel engines and vehicles - Description and illustrations**

- A.2.1. Description of the counter mechanism
  - A.2.1.1. General
    - A.2.1.1.1. To comply with the requirements of this annex, the system shall contain a counter to record the number of hours during which the engine has been operated while the system has detected a malfunctioning gas supply.
    - A.2.1.1.2. This counter shall be capable of counting up to 30 minutes operating time. The counter intervals shall be no longer than 3 minutes. When reaching its maximum value permitted by the system, it shall hold that value unless the conditions allowing the counter to be reset to zero are met.
  - A.2.1.2. Principle of the counter mechanism
    - A.2.1.2.1. The counters shall operate as follows:
      - A.2.1.2.1.1. If starting from zero, the counter shall begin counting as soon as a malfunctioning gas supply is detected according to paragraph 7.2 of this annex and the corresponding diagnostic trouble code (DTC) has the status confirmed and active.
      - A.2.1.2.1.2. The counter shall halt and hold its current value if a single monitoring event occurs and the malfunction that originally activated the counter is no longer detected or if the failure has been erased by a scan tool or a maintenance tool.
        - A.2.1.2.1.2.1. The counter shall also halt and hold its current value when the service mode becomes active.
      - A.2.1.2.1.3. Once frozen, the counter shall be reset to zero and restart counting if a malfunction relevant to that counter is detected and the service mode activated.
        - A.2.1.2.1.3.1. Once frozen, the counter shall also be reset to zero when the monitors relevant to that counter have run at least once to completion of their monitoring cycle without having detected a malfunction and no malfunction relevant to that counter has been detected during 36 engine operating hours since the counter was last held.
  - A.2.1.3. Illustration of the counter mechanism

Figures A2.1.1 to A2.1.3 give via three use-cases an illustration of the counter mechanism



Figure A2.1.1  
**Illustration of the gas supply counter mechanism (Type A HDDF) - use-case 1**

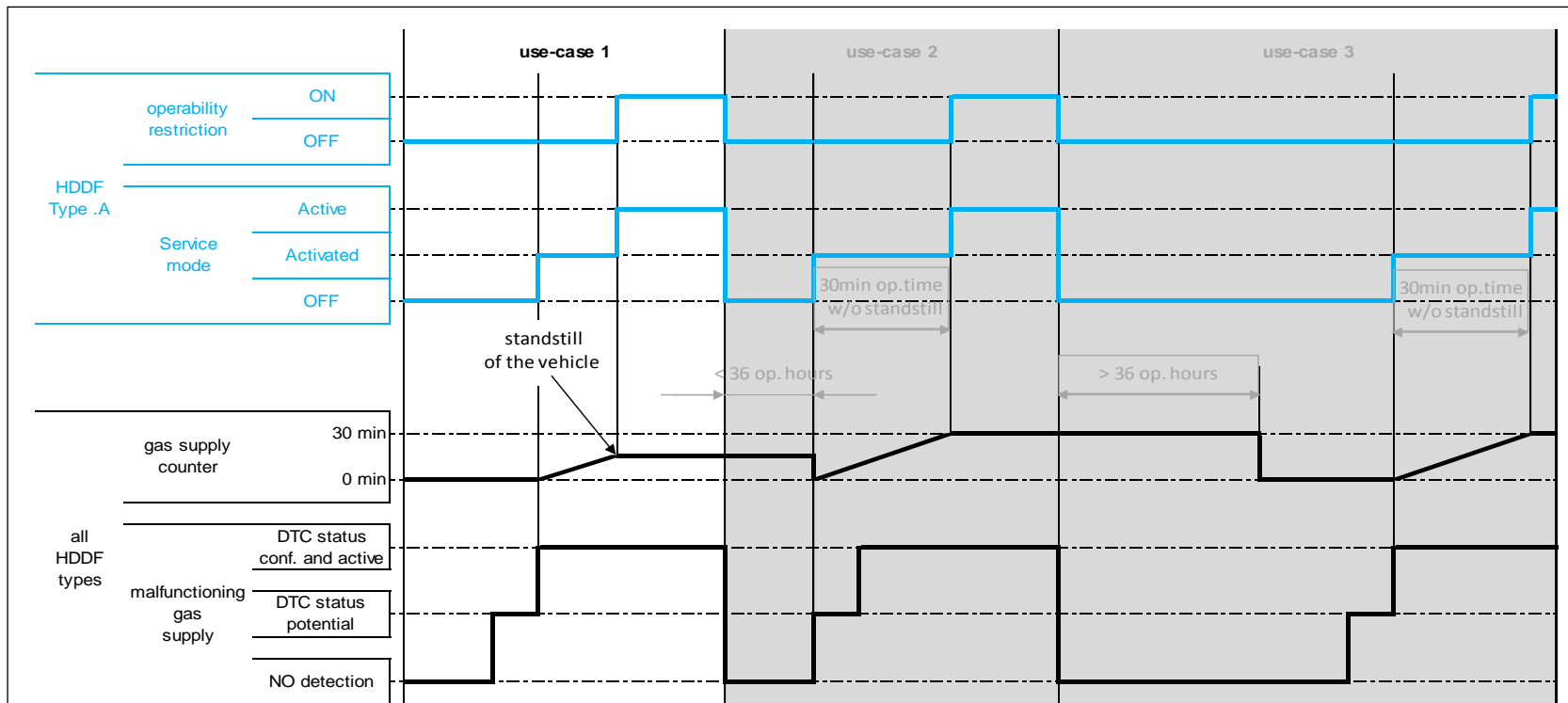

A malfunction of the gas supply is detected for the very first time.

The service mode is activated and the counter starts counting once the DTC gets the "confirmed and active" status (2<sup>nd</sup> detection).

The vehicle encounters a stand-still situation before reaching 30 minutes operating time after the service mode is activated.

The service mode becomes active and the vehicle speed is limited to 20 km/h (see paragraph 4.2.2.1. of this annex).

The counter freezes at its present value.

Figure A2.1.2  
**Illustration of the gas supply counter mechanism (Type A HDDF) - use-case 2**

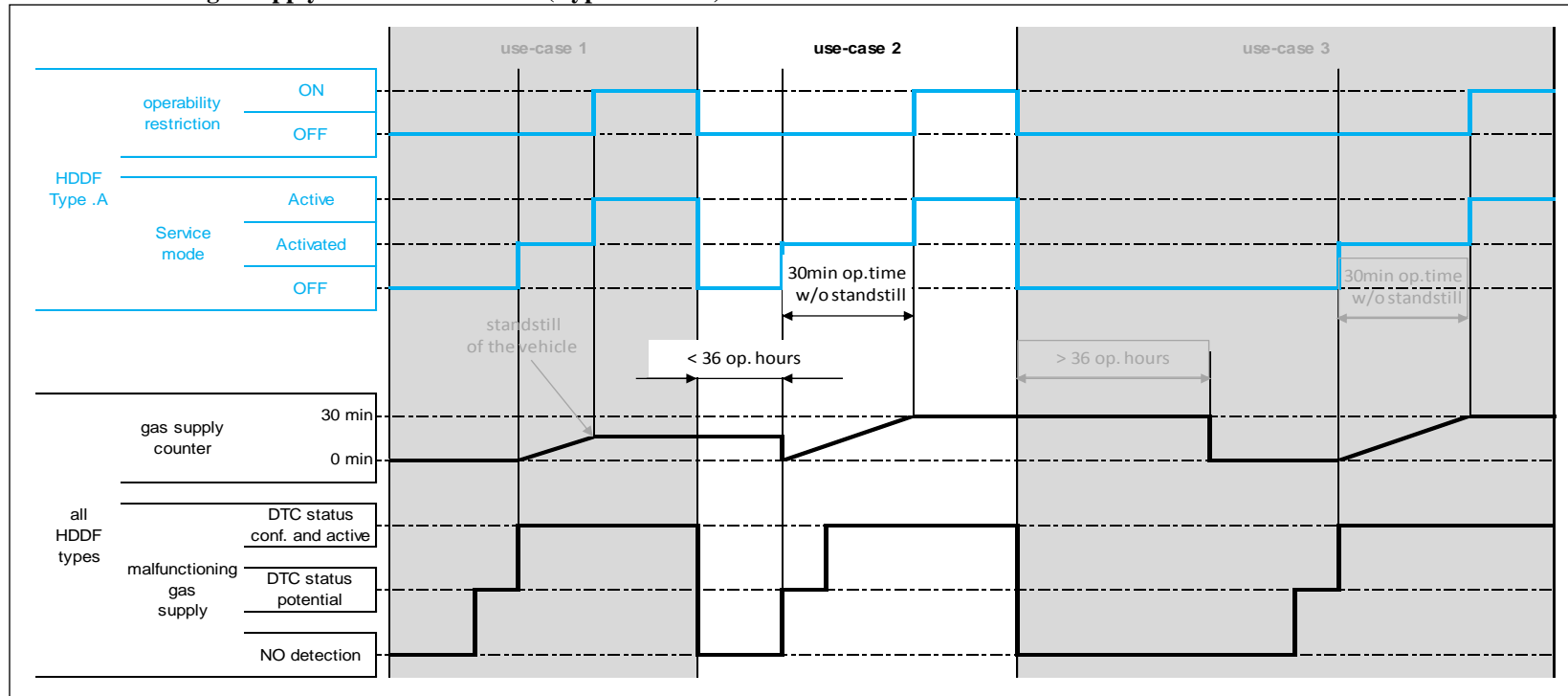

A malfunction of the gas supply is detected while the gas supply malfunction counter is not at zero (in this use-case it indicates the value it reached in use-case 1 when the vehicle became standstill).

The service mode is activated and the counter restarts counting from zero as soon as the DTC gets the "potential" status (1<sup>st</sup> detection: see paragraph 4.2.3.2.1. of this annex).

After 30 minutes of operation without a standstill situation, the service mode becomes active and the vehicle speed is limited to 20 km/h (see paragraph 4.2.2.1 of this annex).

The counter freezes at a value of 30 minutes operating time.

Figure A2.1.3

**Illustration of the gas supply counter mechanism (Type A HDDF) - use-case 3**

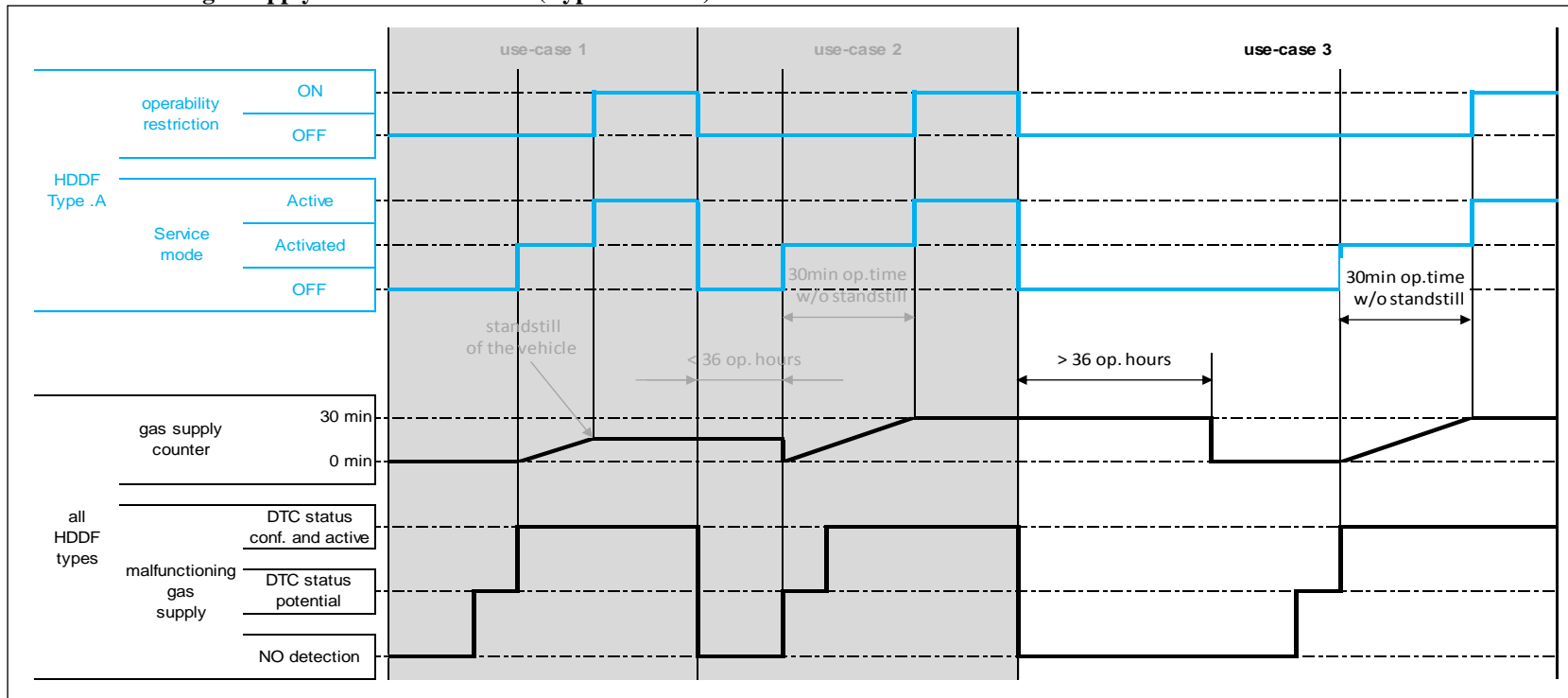

After 36 operating hours without detection of a malfunction of the gas supply, the counter is reset to zero (see paragraph A.2.1.2.3.2.1).

A malfunction of the gas supply is again detected while the gas supply malfunction counter is at zero (1<sup>st</sup> detection).

The service mode is activated and the counter starts counting once the DTC gets the "confirmed and active" status (2<sup>nd</sup> detection).

After 30 minutes of operation without a standstill situation, the service mode becomes active and the vehicle speed is limited to 20 km/h (see paragraph 4.2.2.1 of this annex).

The counter freezes at a value of 30 minutes operating time.

A.2.2. Illustration of the other activation and deactivation mechanisms

A.2.2.1. Empty gas tank

Figure A2.2 gives an illustration of the events occurring in the case of a HDDF vehicle when a gas tank becomes empty through one typical use-case.

Figure A2.2

**Illustration of the events occurring in case of an empty gas tank (Types A and B HDDF)**

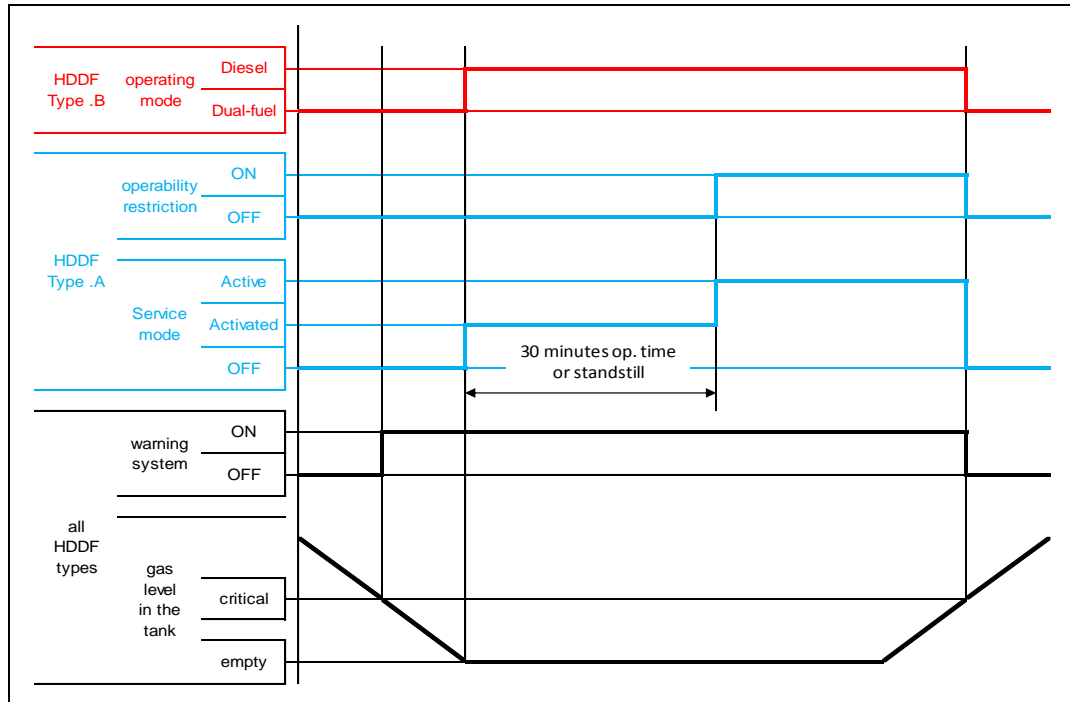

In that use case:

- (a) The warning system specified in paragraph 4.3.2. of becomes active when the level of gas reaches the critical level defined by the manufacturer;
- (b) The service mode is activated (in the case of a Type A HDDF) or the engine switches to Diesel mode (in the case of a Type B HDDF).

In the case of a Type A HDDF, the service mode becomes active and the vehicle speed is limited to 20 km/h after the next time the vehicle is stationary or after 30 minutes operating time without standstill (see paragraph 4.2.2.1. of this annex).

The gas tank is refilled.

The vehicle operates again in dual-fuel mode as soon as the tank is refilled above the critical level.

A.2.2.2. Malfunctioning gas supply

Figure A2.3 gives via one typical use-case an illustration of the events occurring in the case of a malfunction of the gas supply system. This illustration should be understood as complementary to that given in section A.2.1 and dealing with the counter mechanism.

Figure A2.3

**Illustration of the events occurring in case of a malfunctioning gas supply system (Types A and B HDDF)**

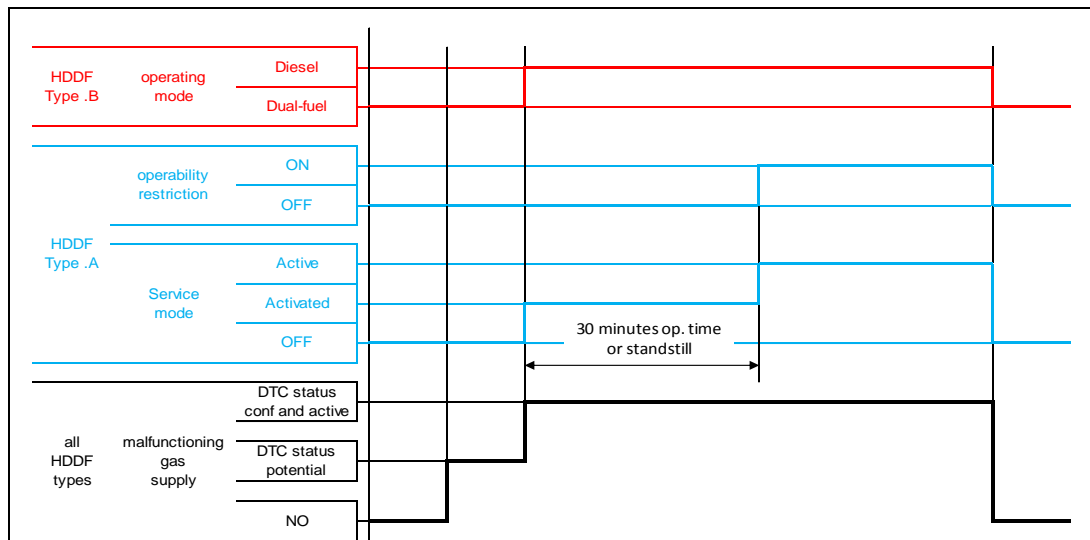

In that use case:

- (a) The failure of the gas supply system occurs for the very first time. The DTC gets the potential status (1<sup>st</sup> detection);
- (b) The service mode is activated (in the case of a Type A HDDF) or the engine switches to Diesel mode (in the case of a Type B HDDF) as soon as the DTC gets the “confirmed and active” status (2<sup>nd</sup> detection).

In the case of a Type A HDDF, the service mode becomes active and the vehicle speed is limited to 20 km/h after the next time the vehicle is stationary or after 30 minutes operating time without standstill (see paragraph 4.2.2.1 of this annex).

The vehicle operates again in dual-fuel mode as soon as the failure is repaired.

A.2.2.3. Abnormality of the gas consumption

Figure A2.4 gives via one typical use-case an illustration of the events occurring in the case of an abnormality of the gas consumption.

Figure A2.4  
**Illustration of the events occurring in case of abnormality of gas consumption  
 (Types A and B HDDF)**

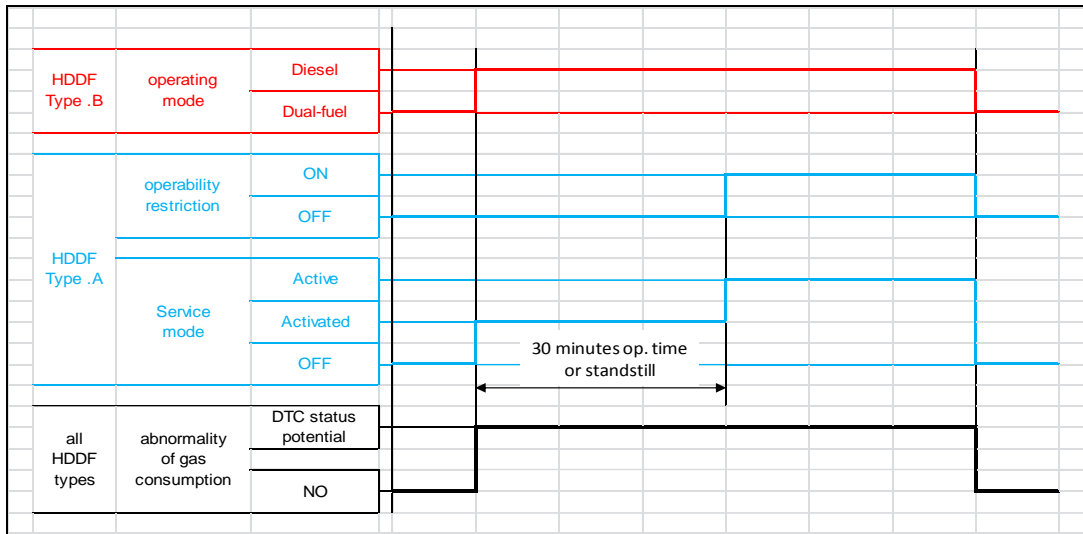

In that use case the service mode is activated (in the case of a Type A HDDF) or the engine switches to Diesel mode (in the case of a Type B HDDF) as soon as the DTC gets the "potential" status (1<sup>st</sup> detection).

In the case of a Type A HDDF, the service mode becomes active and the vehicle speed is limited to 20 km/h after the next time the vehicle is stationary or after 30 minutes operating time without standstill (see paragraph 4.2.2.1. of this annex).

The vehicle operates again in dual-fuel mode as soon as the abnormality is rectified.

## Annex 15 - Appendix 3

### **HDDF dual-fuel indicator, warning system, operability restriction - Demonstration requirements**

#### A.3.1. Dual-fuel indicators

##### A.3.1.1. Dual-fuel mode indicator

In the case where a dual-fuel engine is type approved as a separate technical unit, the ability of the engine system to command the activation of the dual-fuel mode indicator when operating in dual-fuel mode shall be demonstrated at type-approval.

In the case where a dual-fuel vehicle is type approved as regards to its emissions, the activation of the dual-fuel mode indicator when operating in dual-fuel mode shall be demonstrated at type-approval.

*Note:* Installation requirements related to the dual-fuel mode indicator of an approved dual-fuel engine are specified in paragraph 6.2. of this annex.

##### A.3.1.2. Diesel mode indicator

In the case where a dual-fuel engine of Type 1B, Type 2B, or Type 3B is type approved as a separate technical unit, the ability of the engine system to command the activation of the diesel mode indicator when operating in diesel mode shall be demonstrated at type-approval.

In the case where a dual-fuel vehicle of Type 1B, Type 2B, or Type 3B is type approved as regards to its emissions, the activation of the diesel mode indicator when operating in diesel mode shall be demonstrated at type-approval.

*Note:* Installation requirements related to the diesel mode indicator of an approved Type 1B, Type 2B, or Type 3B dual-fuel engine are specified in paragraph 6.2. of this annex.

##### A.3.1.3. Service mode indicator

In the case where a dual-fuel engine is type approved as a separate technical unit, the ability of the engine system to command the activation of the service mode indicator when operating in service mode shall be demonstrated at type-approval.

In the case where a dual-fuel vehicle is type approved with regard to its emissions, the activation of the service mode indicator when operating in service mode shall be demonstrated at type-approval.

*Note:* Installation requirements related to the service mode indicator of an approved dual-fuel engine are specified in paragraph 6.2. of this annex.

- A.3.1.3.1. When so-equipped it is sufficient to perform the demonstration related to the service mode indicator by activating a service mode activation switch and to present the Type Approval Authority with evidence showing that the activation occurs when the service mode is commanded by the engine system itself (for example, through algorithms, simulations, result of in-house tests, etc. ...).

- A.3.2.           Warning system
- In the case where a dual-fuel engine is type approved as a separate technical unit, the ability of the engine system to command the activation of the warning system in the case that the amount of gas in the tank is below the warning level, shall be demonstrated at type-approval.
- In the case where a dual-fuel vehicle is type-approved as regards to its emissions the activation of the warning system in the case that the amount of gas in the tank is below the warning level, shall be demonstrated at type-approval. For that purpose, at the request of the manufacturer and with the approval of the Type Approval Authority, the actual amount of gas may be simulated.
- Note:* Installation requirements related to the warning system of an approved dual-fuel engine are specified in paragraph 6.2. of this annex.
- A.3.3.           Operability restriction
- In the case where a Type 1A or Type 2A dual-fuel engine is type approved as a separate technical unit, the ability of the engine system to command the activation of the operability restriction upon detection of an empty gaseous fuel tank, of a malfunctioning gas supply system, and of an abnormality of gas consumption in dual-fuel mode shall be demonstrated at type-approval.
- In the case where a Type 1A or Type 2A dual-fuel vehicle is type approved as regards to its emissions, the activation of the operability restriction upon detection of an empty gaseous fuel tank, of a malfunctioning gas supply system, and of an abnormality of gas consumption in dual-fuel mode shall be demonstrated at type-approval.
- Note:* Installation requirements related to the operability restriction of an approved dual-fuel engine are specified in paragraph 6.2. of this annex.
- A.3.3.1.        The malfunctioning of the gas supply and the abnormality of gas consumption may be simulated at the request of the manufacturer and with the approval of the Type Approval Authority.
- In the case where a Type 1A or Type 2A dual-fuel engine is type approved as a separate technical unit, the ability of the engine system to command the activation of the operability restriction upon detection of an empty gaseous fuel tank, of a malfunctioning gas supply system, and of an abnormality of gas consumption in dual-fuel shall be demonstrated at type-approval.
- In the case where a Type 1A or Type 2A dual-fuel vehicle is type approved as regards to its emissions, the activation of the operability restriction upon detection of an empty gaseous fuel tank, of a malfunctioning gas supply system, and of an abnormality of gas consumption in dual-fuel mode shall be demonstrated at type-approval.
- Note:* Installation requirements related to the operability restriction of an approved dual-fuel engine are specified in paragraph 6.2. of this annex.
- A.3.3.1.        The malfunctioning of the gas supply and the abnormality of gas consumption may be simulated at the request of the manufacturer and with the approval of the Type Approval Authority.
- A.3.3.2.        It is sufficient to perform the demonstration in a typical use-case selected with the agreement of the Type Approval Authority and to present that authority with evidence showing that the operability restriction occurs in the other possible use-cases (for example, through algorithms, simulations, result of in-house tests, etc.



## Annex 15 - Appendix 4

### Additional emission test procedure requirements for dual-fuel engines

#### A.4.1. General

This appendix defines the additional requirements and exceptions to Annex 4 of this regulation to enable emission testing of dual-fuel engines independent whether these emissions are solely exhaust emissions or also crankcase emissions added to the exhaust emissions according to paragraph 6.10. of Annex 4.

Emission testing of a dual-fuel engine is complicated by the fact that the fuel used by the engine can vary between pure diesel fuel and a combination of mainly gaseous fuel with only a small amount of diesel fuel as an ignition source. The ratio between the fuels used by a dual-fuel engine can also change dynamically depending of the operating condition of the engine. As a result special precautions and restrictions are necessary to enable emission testing of these engines.

#### A.4.2. Test conditions (Annex 4, section 6.)

##### A.4.2.1. Laboratory test conditions (Annex 4, paragraph 6.1.)

The parameter  $f_a$  for dual-fuel engines shall be determined with formula (a)(2) in paragraph 6.1. of Annex 4 to this Regulation.

#### A.4.3. Test procedures (Annex 4, section 7.)

##### A.4.3.1. Measurement procedures (Annex 4, paragraph 7.1.3.)

The recommended measurement procedure for dual-fuel engines is procedure (b) listed in paragraph 7.1.3. of Annex 4 (CVS system).

This measurement procedure ensures that the variation of the fuel composition during the test will only influence the hydrocarbon measurement results. This shall be compensated via one of the methods described in section 4.4.

Other measurement methods such as method (a) listed in paragraph 7.1.3. of Annex 4 (raw gaseous/partial flow measurement) can be used with some precautions regarding exhaust mass flow determination and calculation methods. Fixed values for fuel parameters and  $u_{gas}$ -values shall be applied as described in Appendix 6.

#### A.4.4. Emission calculation (Annex 4, section 8.)

The emissions calculation on a molar basis, in accordance with Annex 7 of gtr No. 11 concerning the exhaust emission test protocol for Non-Road Mobile Machinery (NRMM), is not permitted.

##### A.4.4.1. Dry/wet correction (Annex 4, section 8.1.)

##### A.4.4.1.1. Raw exhaust gas (Annex 4, paragraph 8.1.1.)

Equations 15 and 17 in Annex 4, paragraph 8.1.1. shall be used to calculate the dry/wet correction.

The fuel specific parameters shall be determined according to sections A.6.2. and A.6.3. of Appendix 6.

A.4.4.1.2. Diluted exhaust gas (Annex 4, paragraph 8.1.2.)

Equations 19 and 20 in Annex 4 paragraph 8.1.2. shall be used to calculate the wet/dry correction.

The molar hydrogen ratio  $\alpha$  of the combination of the two fuels shall be used for the dry/wet correction. This molar hydrogen ratio shall be calculated from the fuel consumption measurement values of both fuels according to section A.6.4. of Appendix 6.

A.4.4.2. NO<sub>x</sub> correction for humidity (Annex 4, section 8.2.)

The NO<sub>x</sub> humidity correction for compression ignition engines as specified in paragraph 8.2.1. of Annex 4 shall be used to determine the NO<sub>x</sub> humidity correction for dual-fuel engines.

$$k_{h,D} = \frac{15,698 \times H_a}{1000} + 0,832 \quad (\text{A4.1})$$

where:

$H_a$  is the intake air humidity, g water per kg dry air

A.4.4.3. Partial flow dilution (PFS) and raw gaseous measurement (Annex 4, section 8.4.)

A.4.4.3.1. Determination of exhaust gas mass flow (Annex 4, paragraph 8.4.1.)

The exhaust mass flow shall be determined according to the direct measurement method as described in section 8.4.1.3.

Alternatively the airflow and air to fuel ratio measurement method according to paragraph 8.4.1.6. (equations 30, 31 and 32) may be used only if  $\alpha$ ,  $\gamma$ ,  $\delta$  and  $\varepsilon$  values are determined according to sections A.6.2. and A.6.3. of Appendix 6. The use of a zirconia-type sensor to determine the air fuel ratio is not allowed.

A.4.4.3.2. Determination of the gaseous components (Annex 4, section 8.4.2.)

The calculations shall be performed according to Annex 4, section 8. but the  $u_{gas}$ -values and molar ratios as described in section A.6.2. and A.6.3. of Appendix 6 shall be used.

A.4.4.3.3. Particulate determination (Annex 4, section 8.4.3.)

For the determination of particulate emissions with the partial dilution measurement method the calculation shall be performed according to Annex 4, paragraph 8.4.3.2.

For controlling the dilution ratio one of the following two methods may be used:

- The direct mass flow measurement as described in paragraph 8.4.1.3.
- The airflow and air to fuel ratio measurement method according to paragraph 8.4.1.6. (equations 30, 31 and 32) may only be used when this is combined with the look ahead method described in paragraph 8.4.1.2. and if  $\alpha$ ,  $\gamma$ ,  $\delta$  and  $\varepsilon$  values are determined according to sections A.6.2. and A.6.3. of Appendix 6.

The quality check according to paragraph 9.4.6.1. shall be performed for each measurement.

A.4.4.3.4. Additional requirements regarding the exhaust gas mass flow meter

The flow meter referred to in sections A.4.4.3.1. and A.4.4.3.3. shall not be sensitive to the changes in exhaust gas composition and density. The small errors of e.g. pitot tube or orifice-type of measurement (equivalent with the square root of the exhaust density) may be neglected.

A.4.4.4. Full flow dilution measurement (CVS) (Annex 4, section 8.5.)

The possible variation of the fuel composition will only influence the hydrocarbons measurement results calculation. For all other components the appropriate equations from section 8.5.2. of Annex 4 shall be used.

The exact equations shall be applied for the calculation of the hydrocarbon emissions using the molar component ratios determined from the fuel consumption measurements of both fuels according to section A.6.4. of Appendix 6.

A.4.4.4.1. Determination of the background corrected concentrations (Annex 4, paragraph 8.5.2.3.2.)

To determine the stoichiometric factor, the molar hydrogen ratio  $\alpha$  of the fuel shall be calculated as the average molar hydrogen ratio of the fuel mix during the test according to section A.6.4. of Appendix 6.

Alternatively the  $F_s$  value of the gaseous fuel may be used in equation 59 or 60 of Annex 4.

A.4.5. Equipment specification and verification (Annex 4, section 9.)

A.4.5.1. Oxygen interference check gases (Annex 4, paragraph 9.3.3.4.)

The oxygen concentrations required for dual-fuel engines are equal to those required for compression ignition engines listed in table 8 in paragraph 9.3.3.4. of Annex 4.

A.4.5.2. Oxygen interference check (Annex 4, paragraph 9.3.7.3.)

Instruments used to measure dual-fuel engines shall be checked using the same procedures as those used to measure compression ignition engines. The 21 per cent oxygen blend shall be used under item (b) in paragraph 9.3.7.3. of Annex 4.

A.4.5.3. Water quench check (Annex 4, paragraph 9.3.9.2.2.)

The water quench check in paragraph 9.3.9.2.2. of Annex 4 to this regulation applies to wet NO<sub>x</sub> concentration measurements only. For dual-fuel engines fuelled with natural gas this check should be performed with an assumed H/C ratio of 4 (Methane). In that case  $H_m = 2 \times A$ . For dual-fuel engines fuelled with LPG this check should be performed with an assumed H/C ratio of 2.525. In that case  $H_m = 1.25 \times A$ .

## Annex 15 - Appendix 5

### **Additional PEMS emission test procedure requirements for dual-fuel engines**

#### A.5.1. General

This appendix defines the additional requirements and exceptions to Annex 8 of this regulation to enable PEMS emission testing of dual-fuel engines.

Emission testing of a dual-fuel engine is complicated by the fact that the fuel used by the engine can vary between pure diesel fuel and a combination of mainly gaseous fuel with only a small amount of diesel fuel as an ignition source. The ratio between the fuels used by a dual-fuel engine can also change dynamically depending of the operating condition of the engine. As a result special precautions and restrictions are necessary to enable emission testing of these engines.

#### A.5.2. The following amendments to Appendix 1 of Annex 8 shall apply:

##### A.5.2.1. Note (2) of Table 1 in paragraph A.1.2.2. shall read:

<sup>(2)</sup> Only for engines fuelled with natural gas

##### A.5.2.2. Paragraph A.1.3.3. "Dry-Wet correction" shall read:

If the concentration is measured on a dry basis, it shall be converted to a wet basis according to paragraph 8.1. of Annex 4 and paragraph 4.1.1. of Appendix 4 to this annex.

##### A.5.2.3. Paragraph A.1.3.5. "Calculation of the instantaneous gaseous emissions" shall read:

The mass emissions shall be determined as described in paragraph 8.4.2.3. of Annex 4. The  $u_{gas}$  values shall be determined according to sections A.6.2. and A.6.3. of appendix 6 of Annex 15.

## Annex 15 - Appendix 6

### Determination of molar component ratios and $u_{gas}$ values for dual-fuel engines

#### A.6.1. General

This appendix defines the determination of molar component ratios and  $u_{gas}$  values for the dry-wet factor and emissions calculations for emission testing of dual-fuel engines.

#### A.6.2. Operation in dual-fuel mode

A.6.2.1. For Type 1A or 1B dual-fuel engines operating in dual-fuel mode the molar component ratios and the  $u_{gas}$  values of the gaseous fuel shall be used.

A.6.2.2. For Type 2A or 2B dual-fuel engines operating in dual-fuel mode the molar component ratios and the  $u_{gas}$  values from tables A6.1 and A6.2 shall be used.

Table A6.1

**Molar component ratios for a mixture of 50% gaseous fuel and 50% diesel fuel (mass %)**

Gaseous Fuel	$\alpha$	$\gamma$	$\delta$	$\varepsilon$
CH <sub>4</sub>	2.8681	0	0	0.0040
G <sub>R</sub>	2.7676	0	0	0.0040
G <sub>23</sub>	2.7986	0	0.0703	0.0043
G <sub>25</sub>	2.7377	0	0.1319	0.0045
Propane	2.2633	0	0	0.0039
Butane	2.1837	0	0	0.0038
LPG	2.1957	0	0	0.0038
LPG Fuel A	2.1740	0	0	0.0038
LPG Fuel B	2.2402	0	0	0.0039

Table A6.2

**Raw exhaust gas  $u_{gas}$  values and component densities for a mixture of 50% gaseous fuel and 50% diesel fuel (mass %)**

Gaseous Fuel	$\rho_e$	Gas					
		NO <sub>x</sub>	CO	HC	CO <sub>2</sub>	O <sub>2</sub>	CH <sub>4</sub>
		$\rho_{gas}$ [kg/m <sup>3</sup> ]					
		2.053	1.250	<sup>a)</sup>	1.9636	1.4277	0.716
$u_{gas}$ <sup>b)</sup>							
CNG/LNG <sub>c)</sub>	1.2786	0.001606	0.000978	0.000528 <sup>d)</sup>	0.001536	0.001117	0.000560
Propane	1.2869	0.001596	0.000972	0.000510	0.001527	0.001110	0.000556
Butane	1.2883	0.001594	0.000971	0.000503	0.001525	0.001109	0.000556
LPG <sup>e)</sup>	1.2881	0.001594	0.000971	0.000506	0.001525	0.001109	0.000556

a) depending on fuel  
b) at  $\lambda = 2$ , dry air, 273 K, 101.3 kPa  
c)  $u$  accurate within 0.2 % for mass composition of: C = 58 - 76 %; H = 19 - 25 %; N = 0 - 14 % (CH<sub>4</sub>, G<sub>20</sub>, G<sub>R</sub>, G<sub>23</sub> and G<sub>25</sub>)  
d) NMHC on the basis of CH<sub>2.93</sub> (for total HC the  $u_{gas}$  coefficient of CH<sub>4</sub> shall be used)  
e)  $u$  accurate within 0.2 % for mass composition of: C3 = 27 - 90 %; C4 = 10 - 73 % (LPG Fuels A and B)

A.6.2.3. For Type 3B dual-fuel engines operating in dual-fuel mode the molar component ratios and the  $u_{gas}$  values of diesel fuel shall be used.

A.6.2.4. For the calculation of the hydrocarbon emissions of all types of dual-fuel engines operating in dual-fuel mode, the following shall apply:

- For the calculation of the THC emissions, the  $u_{gas}$  value of the gaseous fuel shall be used.
- For the calculation of the NMHC emissions, the  $u_{gas}$  value on the basis of  $CH_{2.93}$  shall be used.
- For the calculation of the  $CH_4$  emissions, the  $u_{gas}$  value of  $CH_4$  shall be used.

A.6.3. Operation in diesel mode

For Type 1B, 2B or 3B dual-fuel engines operating in diesel mode, the molar component ratios and the  $u_{gas}$  values of diesel fuel shall be used.

A.6.4. Determination of the molar component ratios when the fuel mix is known

A.6.4.1. Calculation of the fuel mixture components

$$w_{ALF} = \frac{w_{ALF1} \times q_{mf1} + w_{ALF2} \times q_{mf2}}{q_{mf1} + q_{mf2}} \quad (A6.1)$$

$$w_{BET} = \frac{w_{BET1} \times q_{mf1} + w_{BET2} \times q_{mf2}}{q_{mf1} + q_{mf2}} \quad (A6.2)$$

$$w_{GAM} = \frac{w_{GAM1} \times q_{mf1} + w_{GAM2} \times q_{mf2}}{q_{mf1} + q_{mf2}} \quad (A6.3)$$

$$w_{DEL} = \frac{w_{DEL1} \times q_{mf1} + w_{DEL2} \times q_{mf2}}{q_{mf1} + q_{mf2}} \quad (A6.4)$$

$$w_{EPS} = \frac{w_{EPS1} \times q_{mf1} + w_{EPS2} \times q_{mf2}}{q_{mf1} + q_{mf2}} \quad (A6.5)$$

where:

$q_{mf1}$	fuel mass flow rate of fuel1, kg/s
$q_{mf2}$	fuel mass flow rate of fuel2, kg/s
$w_{ALF}$	hydrogen content of fuel, per cent mass
$w_{BET}$	carbon content of fuel, per cent mass
$w_{GAM}$	sulphur content of fuel, per cent mass
$w_{DEL}$	nitrogen content of fuel, per cent mass
$w_{EPS}$	oxygen content of fuel, per cent mass

A.6.4.2. Calculation of the molar ratios of H, C, S, N and O related to C for the fuel mixture (according to ISO8178-1, Annex A-A.2.2.2).

$$\alpha = 11.9164 \times \frac{w_{ALF}}{w_{BET}} \quad (A6.6)$$

$$\gamma = 0.37464 \times \frac{w_{GAM}}{w_{BET}} \quad (A6.7)$$

$$\delta = 0.85752 \times \frac{w_{DEL}}{w_{BET}} \quad (A6.8)$$

$$\varepsilon = 0.75072 \times \frac{w_{EPS}}{w_{BET}} \quad (A6.9)$$

where:

$w_{ALF}$	hydrogen content of fuel, per cent mass
$w_{BET}$	carbon content of fuel, per cent mass
$w_{GAM}$	sulphur content of fuel, per cent mass
$w_{DEL}$	nitrogen content of fuel, per cent mass
$w_{EPS}$	oxygen content of fuel, per cent mass
$\alpha$	molar hydrogen ratio (H/C)
$\gamma$	molar sulphur ratio (S/C)
$\delta$	molar nitrogen ratio (N/C)
$\varepsilon$	molar oxygen ratio (O/C)

referring to a fuel  $CH_\alpha O_\varepsilon N_\delta S_\gamma$

#### A.6.4.3. Calculation of the $u_{gas}$ values for a fuel mixture

The raw exhaust gas  $u_{gas}$  values for a fuel mixture can be calculated with the exact equations in paragraph 8.4.2.4. of Annex 4 and the molar ratios calculated according to paragraph A.6.4.2.

For systems with constant mass flow, equation 57 in paragraph 8.5.2.3.1. of Annex 4 is needed to calculate the diluted exhaust gas  $u_{gas}$  values."