

**Economic and Social Council**Distr.: General  
7 August 2017

Original: English

---

**Economic Commission for Europe****Inland Transport Committee****World Forum for Harmonization of Vehicle Regulations****Working Party on Lighting and Light-Signalling****Seventy-eighth session**

Geneva, 24-27 October 2017

Item 4 of the provisional agenda

**Simplification of lighting and light-signalling Regulations****Draft new Regulation on uniform provisions concerning the approval of light-signalling devices (lamps) for power-driven vehicles and their trailers****Submitted by the Informal Working Group on Simplification of Lighting and Light-Signalling Regulations (IWG SLR)\***

The proposal for a new UN Regulation on Light-Signalling Devices (LSD) reproduced below was prepared by the IWG SLR. Some text is shown in square brackets to indicate that consideration and a decision are required.

---

\* In accordance with the programme of work of the Inland Transport Committee for 2016–2017 (ECE/TRANS/254, para. 159 and ECE/TRANS/2016/28/Add.1, cluster 3.1), the World Forum will develop, harmonize and update Regulations in order to enhance the performance of vehicles. The present document is submitted in conformity with that mandate.

GE.17-13390(E)



\* 1 7 1 3 3 9 0 \*

Please recycle The recycling symbol, consisting of three chasing arrows forming a triangle.



## I. Proposal

### **Draft new UN Regulation on uniform provisions concerning the approval of light-signalling devices (lamps) for power-driven vehicles and their trailers**

#### Contents

	<i>Page</i>
1. Scope .....	3
2. Definitions.....	4
3. Administrative provisions .....	4
4. General technical requirements .....	13
5. Specific technical requirements.....	20
<b>Annexes</b>	
1 Communication .....	31
2 Light distribution in space, horizontal and vertical .....	34
3 Standard light distributions .....	39
4 Minimum requirements for conformity of production control procedures.....	47
5 Minimum requirements for sampling by an inspector.....	50
6 Heat resistance test for rear fog lamps and daytime running lamps .....	52
7 Arrangement of approval marks.....	53

## Introduction

This UN Regulation combines the provisions of individual Regulations Nos. 4, 6, 7, 23, 38, 50, 77, 87 and 91 into a single Regulation, and is the outcome of the World Forum for Harmonization of Vehicle Regulations (WP.29) decision to simplify the lighting and light-signalling Regulations based on the initial proposal by the European Union and Japan.

The objective of this UN Regulation is to increase the clarity, to consolidate and streamline the complexity of requirements in Regulations Nos. 4, 6, 7, 23, 38, 50, 77, 87 and 91 and to prepare for the future transition to performance based requirements, by reducing the number of Regulations through an editorial exercise without changing any of the detailed technical requirements already in force up to the date of entry into force of this UN Regulation.

Although this UN Regulation departs from the traditional approach of having a separate Regulation for each lamp, by combining all light signalling lamps into a single Regulation, this simplified Regulation contains all provisions and operates according to the existing structure of series of amendments, their transitional provisions and supplements. The transitional provisions associated with a new series of amendments to this UN Regulation will be identified for each device as applicable, this also includes a list of devices and their applicable series of amendments.

It is expected that all Contracting Parties to the 1958 Agreement will adopt this UN Regulation and will provide detailed explanation in case they are not in a position to adopt particular lamps. These decisions will be registered in ECE/TRANS/WP.29/343 that records the status of the annexed Regulations and of the amendments.

Regarding the requirements for approval markings, this UN Regulation includes the requirements for the use of the "Unique Identifier" and is conditional upon access to a secure internet database established by UNECE (in accordance with Schedule 5 of the 1958 Agreement) where all type approval documentation is held. When the "Unique Identifier" is used there is no requirement for the lamps to carry the conventional type approval markings (E-mark). If it is technically not possible to use the "Unique Identifier" (e.g. if the access to the UNECE internet database cannot be secured or the database is not operational), the use of conventional type approval markings is required until the use of the "Unique Identifier" is enabled.

## 1. Scope

This UN Regulation applies to the following lamps:

- Rear-registration plate illuminating lamps
- Direction indicator lamps
- Position lamps
- Stop lamps
- End-outline marker lamps
- Reversing lamps
- Manoeuvring lamps
- Rear fog lamps
- Parking lamps
- Daytime running lamps
- Side marker lamps

## 2. Definitions

For the purposes of this UN Regulation:

- 2.1 All the definitions given in Regulation No. 48 and its series of amendments in force at the time of application for type approval shall apply, unless otherwise specified.
- 2.1.1. "*Lamps of different types*" means lamps, which differ in such essential respects as:
- (a) The trade name or mark:
    - (i) Lamps bearing the same trade name or mark but produced by different manufacturers are considered as being of different types;
    - (ii) Lamps produced by the same manufacturer differing only by the trade name or mark are considered as being of the same type.
  - (b) The characteristics of the optical system (levels of intensity, light distribution angles, , inclusion or elimination of components capable of altering the optical effects by reflection, refraction, absorption and/or deformation during operation, etc.);
  - (c) The category or categories of light source(s) used and/or the specific identification code (s) of the light source module(s);
  - (d) The category of the lamp, if any;
  - (e) The variable intensity control, if any;
  - (f) The sequential activation of light sources, if any.

Nevertheless, direction indicators capable of being activated in different modes (sequential or not) without any modification of the optical characteristics of the lamp do not constitute "*Direction indicators of different types*".

A change of the colour of the light source or the colour of any filter does not constitute a change of type.

## 3. Administrative Provisions

- 3.1. APPLICATION FOR APPROVAL
- 3.1.1 The application for type approval shall be submitted by the holder of the trade name or mark or by his duly accredited representative.
- 3.1.2 It shall be accompanied by:
- 3.1.2.1 drawings, sufficiently detailed to permit identification of the type and, if applicable, of the category of the lamp, showing:
- (a) Geometrically in what position(s) the lamp (and if applicable for category S3 or S4 stop lamps the rear window) may be mounted on the vehicle;
  - (b) The axis of observation to be taken as the axis of reference in the tests (horizontal angle  $H = 0^\circ$ , vertical angle  $V = 0^\circ$ ); and the point to be taken as the centre of reference during the tests;

- (c) The limit of the apparent surface of the function(s);
  - (d) The position intended for the approval mark and the additional symbols in relation to the circle of the approval mark or the “Unique Identifier”;
  - (e) In case of light-emitting diode (LED) module(s) also the space reserved for the specific identification code(s) of the module(s);
  - (f) In the case of an interdependent lamp system, the interdependent lamp or the combination of interdependent lamps.
- 3.1.2.2. A brief technical description stating in particular, with the exception of lamps with non-replaceable light sources:
- (a) The category or categories of filament light source(s) prescribed; this filament light source category shall be one of those contained in Regulation No. 37;
  - (b) The category or categories of LED light source(s) prescribed; this LED light source category shall be one of those contained in Regulation No. 128;
  - (c) The light source module specific identification code;
  - (d) In the case of a category S3 or S4 stop lamp, which is intended to be mounted inside the vehicle, the technical description shall contain the specification of the optical properties (transmission, colour, inclination, etc.) of the rear window(s).
- 3.1.2.3. However, in the case of a type of lamp differing only by the trade name or mark from a type that has already been approved it is sufficient that the application is accompanied by:
- 3.1.2.3.1. A declaration by the lamp manufacturer that the type submitted is identical (except in the trade name or mark) with and has been produced by the same manufacturer as the type already approved, the latter being identified by its approval code;
- 3.1.2.3.2. Two samples bearing the new trade name or mark or equivalent documentation.
- 3.1.2.4. In the case of a lamp with variable intensity, a concise description of the variable intensity control, an arrangement diagram and a specification of the characteristics of the system ensuring the two levels of intensity;
- 3.1.2.5. If applicable in the case of a non-replaceable filament light source(s) or light source module(s) equipped with non-replaceable filament light source(s), the documents according to paragraph 3.5.3.;
- 3.1.2.6. At the discretion of the applicant, the description may specify if the lamp may be installed on the vehicle with different inclinations of the reference axis in respect to the vehicle reference planes and to the ground, or rotate around its reference axis; these different conditions of installation shall be indicated in the communication form.
- 3.1.2.7. If not otherwise specified for the relevant lamp, the following samples:
- (a) Two complete samples of the lamp.
- If application is made for the approval of lamps which are not identical but are symmetrical and suitable for mounting one on the left

and one on the right side of the vehicle, the two samples submitted may be identical and be suitable for mounting only on the right or only on the left side of the vehicle;

(b) For a variable-intensity lamp, a sample of the variable intensity control or a generator providing the same signal(s).

3.1.2.8. In the case of a category S3 or S4 stop lamp which is intended to be mounted inside the vehicle, a sample plate or sample plates (in case of different possibilities) having the equivalent optical properties corresponding to those of the actual rear window(s).

3.2. APPROVAL

3.2.1. A separate approval is required for each lamp listed in paragraph 1.

3.2.2. When two or more lamps are part of the same unit of grouped, combined or reciprocally incorporated lamps, approval may be granted only if each of these lamps satisfy the provisions set out in this UN Regulation or in another Regulation. Lamps not satisfying the provisions of any of those Regulations shall not be part of such unit of grouped, combined or reciprocally incorporated lamps.

3.2.3. If the type of lamp(s) submitted for approval in pursuance of paragraph 3.1. meets the requirements of this UN Regulation, approval shall be granted. All the devices of an interdependent lamp system must be submitted for type approval by the same applicant.

3.2.3.1. Notice of approval or of extension or refusal or withdrawal of approval or production definitely discontinued of a type of a lamp pursuant to this UN Regulation shall be communicated to the Contracting Parties to the 1958 Agreement which apply this UN Regulation, by means of a form conforming to the model in Annex 1;

3.2.3.2. An approval number shall be assigned to each type of lamp approved and shall be indicated for each lamp in the communication form in Annex 1.

A contracting party may assign the same approval number to light-signalling devices or systems incorporating a number of lamps but shall not assign the same number to another type of lamp of the same function.

3.2.4. The identification symbols to be referenced in the paragraph 9.1. of Annex 1 shall be as follows:

Table 1: Symbols

<i>Lamp</i>	<i>Symbol</i>	<i>Paragraph</i>
Daytime running lamp	RL	5.4.
Front direction indicator lamp to be installed at a distance of at least 20mm from passing beam headlamp or front fog lamp	1a	5.6.
Front direction indicator lamp to be installed at any distance from passing beam headlamp or front fog lamp	1b	5.6.
Front direction indicator lamp to be installed at a distance of at least 40 mm from passing beam headlamp or front fog lamp	1	5.6.

Direction indicators for the front of the category L vehicle for use at a distance of at least 75 mm from the passing beam headlamp	11	5.6.
Direction indicators for the front of the category L vehicle for use at a distance of at least 40 mm from the passing beam headlamp;	11a	5.6.
Direction indicators for the front of the category L vehicle for use at a distance of at least 20 mm from the passing beam headlamp;	11b	5.6.
Direction indicators for the front of the category L vehicle for use at any distance from the passing beam headlamp	11c	5.6.
Front end-outline marker lamp	AM	5.1.
Front position lamp for category L vehicle	MA	5.1.
Front position lamp	A	5.1.
Manoeuvring lamp	ML	5.10.
Parking lamp (Forward and rearward facing)	77R	5.3.
Rear direction indicator lamp (steady)	2a	5.6.
Rear direction indicator lamp (variable)	2b	5.6.
Rear direction indicator lamp for category L vehicle	12	5.6.
Rear end-outline marker lamp (steady)	RM1	5.2.
Rear end-outline marker lamp (variable)	RM2	5.2.
Rear fog lamp (steady)	F1	5.9.
Rear fog lamp (variable)	F2	5.9.
Rear position lamp for category L vehicle	MR	5.2.
Rear position lamp (steady)	R1	5.2.
Rear position lamp (variable)	R2	5.2.
Rear-registration plate illuminating lamp	L	5.11.
Rear-registration plate illuminating lamp for category L vehicle	LM1	5.11.
Reversing lamp (note: the letters A and R may be mingled)	AR	5.8.
Side direction indicator lamp for vehicles M <sub>1</sub> and vehicles N <sub>1</sub> , M <sub>2</sub> and M <sub>3</sub> up to 6000 mm in length	5	5.6.
Side direction indicator lamp for vehicles N <sub>2</sub> and N <sub>3</sub> and vehicles N <sub>1</sub> , M <sub>2</sub> and M <sub>3</sub> more than 6000 mm in length	6	5.6.
Side marker lamp for all vehicle categories	SM1	5.7.
Side marker lamp for M <sub>1</sub> vehicles	SM2	5.7.
Stop lamp (central high mounted) (steady)	S3	5.5.
Stop lamp (central high mounted) (variable)	S4	5.5.
Stop lamp for category L vehicle	MS	5.5.
Stop lamp (steady)	S1	5.5.
Stop lamp (variable)	S2	5.5.

## 3.3 APPROVAL MARK

## 3.3.1. General provisions

3.3.1.1. [Every device belonging to an approved type shall comprise a space of sufficient size for the Unique Identifier (UI) as referred to in the 1958 Agreement and other markings as defined in paragraph 3.3.4.2. to 3.3.4.6. or, if technically not possible, the approval mark with the additional symbols and other markings as defined in paragraphs 3.3.4.2. to 3.3.4.6.]

3.3.1.2. Examples of the arrangement of the markings are shown in Annex 7.

3.3.2. The international approval mark shall consist of:

3.3.2.1 A circle surrounding the letter "E" followed by the distinguishing number of the country which has granted approval.

3.3.2.2. The approval number prescribed in paragraph 3.2.3.2.

3.3.2.3 The symbols identifying the light signalling lamps prescribed in paragraph 3.2.4.

3.3.2.4. The two digits of the approval number which indicate the change index in force at the time of issue of the approval.

Table 2: Series of amendments and change index to be used for marking

<i>Lamp - Series of amendment 00 -</i>	<i>Change index</i>
Daytime running lamp	Δ0
Front direction indicator lamp	Δ0
Front direction indicator lamp (Vehicle category L)	Δ0
Front end-outline marker lamp	Δ0
Front position lamp	Δ0
Front position lamp (Vehicle category L)	Δ0
Manoeuvring lamp	Δ0
Parking lamp	Δ0
Rear direction indicator lamp	Δ0
Rear direction indicator lamp (Vehicle category L)	Δ0
Rear end-outline marker lamp	Δ0
Rear fog lamp	Δ0
Rear position lamp	Δ0
Rear position lamp (Vehicle category L)	Δ0
Rear-registration plate illuminating lamp	Δ0
Rear-registration plate illuminating lamp (Vehicle category L)	Δ0
Reversing lamp	Δ0
Side direction indicator lamp	Δ0
Side marker lamp	Δ0
Stop lamp	Δ0
Stop lamp (Vehicle category L)	Δ0
Stop lamp (central high mounted)	Δ0

3.3.2.5. The following additional symbol (or symbols):



- 3.3.2.5.1. On lamps which cannot be mounted on either side of the vehicle indiscriminately, a horizontal arrow showing in which position the lamp is to be mounted.
- 3.3.2.5.1.1. The arrow shall be directed outwards from the vehicle in the case of:
- Direction indicators categories 1, 1a, 1b, 2a, 2b, 11, 11a, 11b, 11c and 12;
  - Front or rear position lamps, front or rear end-outline marker lamps;
  - Reversing lamps in case of reduced light distribution of two reversing lamps.
- 3.3.2.5.1.2. The arrow shall be directed towards the front of the vehicle in the case of direction indicators of categories 5 and 6 and combined parking lamps
- 3.3.2.5.1.3. For direction indicators of category 6 an indication "R" or "L" shall be shown on the lamp, indicating the right or left side of the vehicle.
- 3.3.2.5.2. If applicable, to the right side of the symbol mentioned in paragraph 3.2.4.:
- (a) The additional letter "D", on lamps which may be used as part of an assembly of two independent lamps;
- (b) The additional letter "Y", on lamps which are used as part of an interdependent lamps system.
- 3.3.2.5.3. On lamps with reduced light distribution, see paragraph 1.3. of Annex 3, a vertical arrow starting from a horizontal segment and directed downwards.
- 3.3.2.5.4. The approval mark and the additional symbols shall be placed close to the circle prescribed in paragraph 3.3.2.1.
- 3.3.3. The Unique Identifier mark shall follow the format in the example shown below:

Figure I: Unique identifier

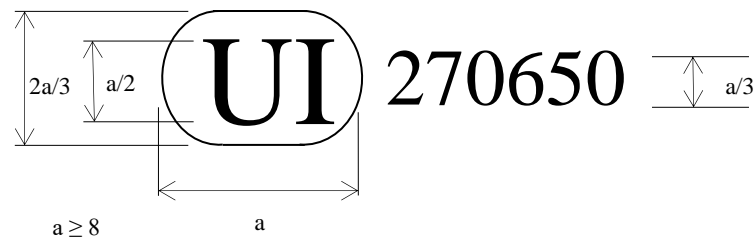

The above Unique Identifier marked on the lamp shows that the type concerned has been approved and that the relevant information on that type approval can be accessed on the UN secure internet database by using 270650 as the Unique Identifier.

### 3.3.4. MARKING REQUIREMENTS

Lamps submitted for approval shall:

- 3.3.4.1. Comprise a space of sufficient size for the approval marking and the additional symbols as prescribed in paragraph 3.3.2. or the Unique Identifier as prescribed in paragraph 3.3.3.; this space shall be shown in the drawings mentioned in paragraph 3.1.2.1.

- 3.3.4.1.1. In any case the approval mark and the additional symbols or the Unique Identifier shall be visible when the lamp is fitted on the vehicle or when a movable part such as the hood or boot lid or a door is opened.
- 3.3.4.1.2. The approval mark and the additional symbols shall be placed on an inner or outer part (transparent or not) of the lamp which cannot be separated from the transparent part of the lamp emitting the light.
- 3.3.4.2. Bear the trade name or mark of the applicant; this marking shall be clearly legible and indelible.
- 3.3.4.3. With the exception of lamps with non-replaceable light sources, bear a clearly legible and indelible marking indicating:
  - (a) The category or categories of light source(s) prescribed; and/or
  - (b) The light source module specific identification code.
- 3.3.4.4. In the case of lamps with:
  - (a) An electronic light source control gear; or
  - (b) A variable luminous intensity control; and/or
  - (c) A secondary operating mode; and/or
  - (d) Non-replaceable light sources; and/or
  - (e) Light source module(s);
 Bear marking of the rated voltage or the range of voltage;
- 3.3.4.5. In the case of lamps with light source module(s) on the light source module(s) bear marking of:
  - (a) The trade name or mark of the applicant;
  - (b) The specific identification code of the module; This specific identification code shall comprise the starting letters "MD" for "MODULE" followed by the approval mark without the circle as prescribed in paragraph 3.3.2. or by the UI without the truncated circle as prescribed in paragraph 3.3.3.. The approval mark or the UI does not have to be the same as the one on the lamp in which the module is used, but both marks shall be from the same applicant;
  - (c) The rated voltage or the range of voltage.
- 3.3.4.6. An electronic light source control gear or variable luminous intensity control being part of the lamp, but not included into the lamp body, shall be marked with the name of the manufacturer and its identification number.
- 3.3.4.7. The markings in paragraphs 3.3.4.2. to 3.3.4.6. shall be affixed in an indelible and clearly legible manner on the lamp but do not need to fulfil the requirements of paragraph 3.3.4.1..
- 3.3.5. **GROUPED, COMBINED OR RECIPROCALLY INCORPORATED LAMPS**
- 3.3.5.1. Where grouped, combined or reciprocally incorporated lamps have been found to comply with the requirements of several Regulations, a single international approval mark may be affixed, consisting of a circle surrounding the letter "E" followed by the distinguishing number of the country which has granted the approval, and an approval number. This

approval mark may be located anywhere on the grouped, combined or reciprocally incorporated lamps, provided that:

- 3.3.5.1.1. It is visible after their installation;
- 3.3.5.1.2. No part of the grouped, combined or reciprocally incorporated lamps that transmits light can be removed without at the same time removing the approval mark.
- 3.3.5.2. The identification symbol for each lamp together with the corresponding change index incorporating the most recent major technical amendments to the Regulation at the time of issue of the approval and, if necessary, the required additional symbols shall be marked:
  - 3.3.5.2.1. Either on the appropriate light emitting surface;
  - 3.3.5.2.2. Or in a group, in such a way that each of the grouped, combined or reciprocally incorporated lamps may be clearly identified.
- 3.3.5.3. The size of the components of a single approval mark shall not be less than the minimum size required for the smallest of the individual marks under which approval has been granted.
- 3.3.5.4. Annex 7 gives examples of approval marks for grouped, combined or reciprocally incorporated lamps with all the above mentioned additional symbols.
- 3.3.5.5. Lamps reciprocally incorporated with other lamps, of which the lens may also be used for other types of devices. The provisions laid down in paragraph 3.3.5. are applicable.

#### 3.4 MODIFICATIONS OF A TYPE OF LAMP FOR MOTOR VEHICLES AND THEIR TRAILERS AND EXTENSION OF APPROVAL

- 3.4.1. Every modification of a type of lamp shall be notified to the Type Approval Authority which approved the type. The Authority may then either:
  - 3.4.1.1. Consider that the modifications made are unlikely to have an appreciable adverse effect and that in any case the lamp still complies with the requirements; or
  - 3.4.1.2. Require a further test report from the technical service responsible for conducting the tests.
- 3.4.2. Confirmation or refusal of approval, specifying the alterations, shall be communicated by the procedure specified in paragraph 3.2.3.1. to the Contracting Parties to the 1958 Agreement applying this UN Regulation.
- 3.4.3. The Type Approval Authority issuing the extension of approval shall assign a series number for such an extension and inform thereof the other Contracting Parties to the 1958 Agreement applying the UN Regulation under which the approval has been granted by means of a communication form conforming to the model in Annex 1.

#### 3.5 CONFORMITY OF PRODUCTION

The conformity of production procedures shall comply with those set out in the 1958 Agreement, Schedule 1 (E/ECE/324-E/ECE/TRANS/505/Rev.3), with the following requirements:

- 3.5.1. Lamps shall be so manufactured as to conform to the type approved under this UN Regulation. The compliance with the requirements set forth in paragraphs 4. and 5. shall be verified as follows:
- 3.5.1.1. The minimum requirements for conformity of production control procedures set forth in Annex 4 shall be complied with;
- 3.5.1.2. The minimum requirements for sampling by an inspector set forth in Annex 5 shall be complied with;
- 3.5.2. The authority which has granted type approval may at any time verify the conformity control methods applied in each production facility. The normal frequency of these verifications shall be once every two years.
- The Contracting Parties to the 1958 Agreement to which this UN Regulation is annexed are not precluded by Article 3 of that Agreement from prohibiting, for lamps installed on vehicles registered by them, certain colours for which provision is made in this UN Regulation, or from prohibiting for all categories or for certain categories of vehicles registered by them stop lamps having only steady luminous intensity.
- 3.5.3. In the case of non-replaceable filament light source(s) or light source module(s) equipped with non-replaceable filament light source(s), the applicant shall annex to the type approval documentation a report, acceptable to the Authority responsible for type approval that demonstrates compliance of these non-replaceable filament light source with the requirements as specified in paragraph 4.11 of IEC 60809, Edition 3.
- 3.6. PENALTIES FOR NON-CONFORMITY OF PRODUCTION
- 3.6.1 The approval granted may be withdrawn if the requirements in this UN Regulation are not met;
- 3.6.2 If a Contracting Party to the 1958 Agreement which applies this UN Regulation withdraws an approval it has previously granted, it shall forthwith so notify the other Contracting Parties applying this UN Regulation, by means of a communication form conforming to the model in Annex 1.
- 3.7 PRODUCTION DEFINITELY DISCONTINUED
- If the holder of the approval completely ceases to manufacture a lamp approved in accordance with this UN Regulation, he shall so inform the authority which granted the approval. Upon receiving the relevant communication, that authority shall inform thereof the other Contracting Parties to the 1958 Agreement applying this UN Regulation by means of a communication form conforming to the model in Annex 1.
- 3.8. NAMES AND ADDRESSES OF TECHNICAL SERVICES RESPONSIBLE FOR CONDUCTING APPROVAL TESTS, AND OF ADMINISTRATIVE DEPARTMENTS
- The Contracting Parties to the 1958 Agreement which apply the Regulation shall communicate to the United Nations Secretariat the names and addresses of the Technical Services responsible for conducting approval tests and of the Administrative Departments which grant approval and to which forms certifying approval or extension or refusal or withdrawal of approval, or the definitive discontinuation of production issued in other countries, are to be sent.

## 4. General technical requirements

Each lamp submitted for approval shall conform to the requirements set forth in paragraphs 4. and 5..

- 4.1 The requirements contained in sections 5 "General specifications" and 6 "Individual specifications" (and in the Annexes referenced in the said sections) of Regulations Nos. 48, 53, 74 or 86, and their series of amendments in force at the time of application for the lamp type approval shall apply to this UN Regulation.

The requirements pertinent to each lamp and to the category/ies of vehicle on which the lamp is intended to be installed shall be applied, where its verification at the moment of lamp type approval is feasible.

- 4.2 The lamps must be so designed and constructed that in normal conditions of use, and notwithstanding the vibrations to which they may be subjected in such use, their satisfactory operation remains assured and they retain the characteristics prescribed by this UN Regulation.

- 4.3 Light sources:

- 4.3.1 In the case of replaceable light source(s):

- 4.3.1.1. The lamp shall only be equipped with light source(s) approved according to Regulation No. 37 and/or Regulation No. 128, provided that no restriction on the use is made in Regulation No. 37 and its series of amendments in force at the time of application for type approval or in Regulation No. 128 and its series of amendments in force at the time of application for type approval.

- 4.3.1.2. In the case of a light source category or categories or type(s) is restricted for use in lamps on vehicles in use and originally equipped with such lamps, the applicant for type approval of the lamp shall declare that the lamp is only intended for installation on those vehicles; this shall be noted in the communication form in Annex 1.

- 4.3.1.3. The design of the lamp shall be such that the light source(s) can be fixed in no other position but the correct one.

- 4.3.1.4. The light source(s) holder shall conform to the characteristics given in IEC Publication 60061. The holder data sheet relevant to the category of light source(s) used, applies.

- 4.3.2 In the case of light source modules, it shall be checked that:

- 4.3.2.1 The design of the light source module(s) shall be such as:

- (a) That each light source module can only be fitted in no other position than the designated and correct one and can only be removed with the use of tool(s);
- (b) If there are more than one light source module used in the housing for a lamp, light source modules having different characteristics cannot be interchanged within the same lamp housing.

- 4.3.2.2. The light source module(s) shall be tamperproof.

- 4.3.2.3. A light source module shall be so designed that regardless of the use of tool(s), it shall not be mechanically interchangeable with any replaceable approved light source.

- 4.3.2.4. In the case of non-replaceable filament light source(s) or light source module(s) equipped with non-replaceable filament light source(s), the applicant shall annex to the type approval documentation a report, acceptable to the Authority responsible for type approval, that demonstrates compliance of these non-replaceable filament light source(s) with the requirements as specified in paragraph 4.11 of IEC 60809, Edition 3.
- 4.4. INDEPENDENT AND INTERDEPENDENT LAMPS
- 4.4.1. An assembly of two independent lamps to be type approved as lamp marked "D" is applicable to front and rear position lamps except for categories MA, MR, stop lamps except for category MS, front and rear end-outline marker lamps and direction indicator lamps except for categories 11, 11a, 11b, 11c and 12;
- 4.4.2. An interdependent lamp system to be type approved as lamps marked "Y" is applicable to front and rear position lamps, stop lamps, front and rear end-outline marker lamps, daytime running lamps and direction indicator lamps of categories 1, 1a, 1b, 2a, 2b.
- 4.5. LAMPS AS SUCH OR GROUPED, COMBINED, RECIPROCALLY INCORPORATED:
- 4.5.1. Lamps having been approved as front or rear position lamps, are deemed being also approved end-outline marker lamps.
- 4.5.2. Front and rear position lamps which are grouped or combined or reciprocally incorporated may also be used as end-outline marker lamps.
- 4.5.3. Position lamps or daytime running lamps, which are reciprocally incorporated with another function, using a common light source, and designed to operate permanently with an additional system to regulate the intensity of the light emitted, are permitted.
- 4.5.4. However, in the case of rear position lamp reciprocally incorporated with a stop lamp, the lamp shall either:
- (a) Be a part of a multiple light source arrangement; or
  - (b) Be intended for use in a vehicle equipped with a failure monitoring system for that function.
- In either case, a note shall be made within the communication document.
- 4.5.5. If the front position lamp incorporates one or more infrared radiation generators, the photometric and colour requirements for this front position lamp shall be met with and without the operation of the infrared radiation generator(s).
- 4.6. FAILURE PROVISIONS
- 4.6.1. Failure of a single lamp containing more than one light source
- 4.6.1.1. In a single lamp containing more than one light source, a group of light sources, wired so that the failure of any one of them causes all of them to stop emitting light, shall be considered to be one light source.
- 4.6.1.2. In case of failure of any one light source in a single lamp containing more than one light source, at least one of the following provisions shall apply:
- (a) The light intensity complies with the minimum intensity required in the pertinent table of standard light distribution in space as shown in

Annex 3 and when all light sources are illuminated the maximum intensities shall not be exceeded; or

- (b) A signal for activation of a tell-tale indicating failure, as indicated in paragraphs 6.4.8., 6.7.8., 6.9.8, 6.10.8., 6.11.8., 6.12.8., 6.13.8. and 6.18.8. of Regulation No. 48, is produced, provided that the luminous intensity in the axis of reference is at least 50 per cent of the minimum intensity required. In this case a note in the communication form states that the lamp is only for use on a vehicle fitted with a tell-tale indicating failure.
- 4.6.1.3. The requirements of paragraph 4.6.1.2. do not apply to daytime running lamps that shall comply with the requirements of paragraph 5.4.4..
- 4.6.1.4. The requirements of paragraph 4.6.1.2. do not apply to direction indicator lamps of category 1, 1a, 1b, 2a, 2b, 11, 11a, 11b, 11c and 12 that shall comply with the requirements of paragraph 5.6.3..
- 4.6.1.5. The requirements of paragraph 4.6.1.2. do not apply to registration plate lamps.
- 4.6.1.6. The requirements of paragraph 4.6.1.2. (b) do not apply to stop- and position lamps for vehicles of category L.
- 4.6.2. In case of failure of the variable intensity control of:
- (a) A rear position lamp category R2 emitting more than the maximum value of category R1;
  - (b) A rear end-outline marker lamp category RM2 emitting more than the maximum value of category RM1;
  - (c) A stop lamp category S2 emitting more than the maximum value of category S1;
  - (d) A stop lamp category S4 emitting more than the maximum value of category S3;
  - (e) A direction indicator of category 2b emitting more than the maximum value of category 2a;
  - (f) A rear fog lamp of category F2 emitting more than the maximum value of category F1.

Requirements of steady luminous intensity of the respective category shall be fulfilled automatically.

#### 4.7. TEST CONDITIONS

4.7.1. All measurements, photometric and colorimetric, shall be made:

- 4.7.1.1. In case of a lamp with replaceable light source, if not supplied by an electronic light source control gear or a variable intensity control, with an uncoloured or coloured standard light source of the category prescribed for the device, supplied with the voltage:
- (a) In the case of filament light source(s), that is necessary to produce the reference luminous flux required for that category of filament light source;
  - (b) In the case of LED light source(s) of [~~6.75 V,~~] 13.5 V or 28.0 V; the luminous flux value produced shall be corrected. The correction factor

is the ratio between the objective luminous flux and the value of the luminous flux found at the voltage applied.

- 4.7.1.2. In the case of a light source, which is operated independently from vehicle supply voltage and fully controlled by the system, or in the case of a light source supplied by a special power supply, the test voltage as specified by the applicant shall be applied to the input terminals of the light source or [~~6.75 V~~] 13.5 V or 28.0 V shall be applied to the input terminals of that system/power supply. The test laboratory may require from the manufacturer this special power supply needed to supply the light sources.
- 4.7.1.3. In the case of a lamp equipped with non-replaceable light sources (filament light sources and other), with the light sources present in the lamp.
- 4.7.1.3.1. If operating directly under vehicle voltage system conditions all measurements on lamps equipped with non-replaceable light sources shall be made at [~~6.75 V~~] 13.5 V or 28.0 V, or at a voltage as specified by the applicant with respect to any other vehicle voltage system.
- 4.7.1.3.2. If operated independently from vehicle supply voltage and fully controlled by the system, or in the case of a light source supplied by a special power supply, the test voltage as specified in paragraph 4.7.1.3.1. shall be applied to the input terminals of that system/power supply. The test laboratory may require from the manufacturer this special power supply needed to supply the light sources.
- 4.7.1.4. In the case of a system that uses an electronic light source control gear or a variable intensity control, being part of the lamp applying at the input terminals of the lamp the voltage declared by the manufacturer or, if not indicated, [~~6.75 V~~] 13.5 V or 28.0 V respectively.
- 4.7.1.5. In the case of a system that uses an electronic light source control gear or a variable intensity control, not being part of the lamp the voltage declared by the manufacturer shall be applied to the input terminals of the lamp.
- 4.7.2. However, in the case of light sources operated by a variable intensity control to obtain variable luminous intensity, photometric measurements shall be performed according to the applicant's description.
- 4.7.3. The test laboratory shall require from the manufacturer the light source control gear or a variable intensity control needed to supply the light source and the applicable functions.
- 4.7.4. The voltage to be applied to the lamp shall be noted in the communication form in Annex 1.
- 4.7.5. The limits of the apparent surface in the direction of the reference axis of a light-signalling lamp shall be determined. However, in the case of category 5 and 6 direction indicators, the limits of the light emitting surface shall be determined.
- 4.7.6. In the case of a category S3 or S4 stop lamp, which is intended to be mounted inside the vehicle a sample plate or sample plates (in case of different possibilities) as supplied (see paragraph 3.1.2.8.) shall be positioned in front of the lamp to be tested, in the geometrical position(s) as described in the application drawing(s) (see paragraph 3.1.2.2.).
- 4.8 PHOTOMETRIC MEASUREMENTS
- 4.8.1. Measurement provisions



- 4.8.1.1. During photometric measurements, stray reflections shall be avoided by appropriate masking.
- 4.8.1.2. In case the results of measurements should be challenged, measurements shall be carried out in such a way as to meet the following requirements:
- 4.8.1.2.1. The distance of measurement shall be such that the law of the inverse of the square of the distance is applicable;
- 4.8.1.2.2. The measuring equipment shall be such that the angular aperture of the receiver viewed from the reference centre of the light is comprised between 10' and 1 degree;
- 4.8.1.2.3. The intensity requirement for a particular direction of observation shall be deemed to be satisfied if that requirement is met in a direction deviating by not more than one-quarter of a degree from the direction of observation.
- 4.8.1.3. In the case where the lamp may be installed on the vehicle in more than one or in a field of different positions the photometric measurements shall be repeated for each position or for the extreme positions of the field of the reference axis specified by the manufacturer.
- 4.8.2. Measurement methods
- 4.8.2.1. The photometric performance shall be checked in accordance with the relevant sub-paragraph of paragraph 4.7..
- 4.8.2.2. For multiple replaceable light sources:  
When equipped with light source(s) at [~~6.75 V,~~] 13.5 V or 28.0 V, the luminous intensity values produced shall be corrected. For these replaceable filament light sources the correction factor is the ratio between the reference luminous flux and the mean value of the luminous flux found at the voltage applied ([~~6.75 V,~~] 13.5 V or 28.0 V).  
For LED light sources the correction factor is the ratio between the objective luminous flux and the mean value of the luminous flux found at the voltage applied ([~~6.75 V,~~]13.5 V or 28.0 V).  
The actual luminous fluxes of light source used shall not deviate more than 5 per cent from the mean value. Alternatively, and in case of filament light sources only, a standard filament light source may be used in turn, in each of the individual positions, operated at its reference flux, the individual measurements in each position being added together.
- 4.8.2.3. For lamps except those equipped with filament light source(s)
- 4.8.2.3.1. For reversing lamps and maneuvering lamps, the luminous intensities measured after one minute and after 10 minutes of operation, shall comply with the minimum and maximum requirements. The luminous intensity distribution after one and after 10 minutes of operation shall be calculated from the luminous intensity distribution measured after photometric stability has occurred by applying at each test point the ratio of luminous intensities measured at HV:
- (a) After one minute;
  - (b) After 10 minutes; and
  - (c) After photometric stability has occurred.

- 4.8.2.3.2. For all other lamps, the luminous intensities measured after 1min and after 30min of operation shall comply with the minimum and maximum requirements.

Operation of direction indicator lamps shall be done in flashing mode ( $f = 1.5$  Hz, duty factor 50 per cent).

The luminous intensity distribution after 1min of operation can be calculated from the luminous intensity distribution after 30min of operation by applying at each test point the ratio of luminous intensities measured at HV after 1min and after 30min of operation.

- 4.8.2.4. Each signalling lamp shall conform to the intensities of light emitted outside the reference axis and within the angular fields defined in the diagrams in Annex 2, the intensity of the light emitted by each of the two lamps supplied shall:

- 4.8.2.4.1. In each direction corresponding to the points in the pertinent light distribution table reproduced in Annex 3, be not less than the product of the minimum specified in the table of each function below, by the percentage specified in the said table of the direction in question;

- 4.8.2.4.2. In no direction within the space from which the light-signalling lamp is visible, exceed the maximum specified in the pertinent table of each function;

- 4.8.3. When an assembly of two independent lamps, to be type approved as lamps marked "D" and having the same function, is deemed to be a single lamp, it shall comply with the requirements for:

- (a) Maximum intensity if all lamps together are lit;
- (b) Minimum intensity if either lamp has failed.

- 4.8.4. An interdependent lamp system shall meet the requirements when all its interdependent lamps are operated together.

However:

- (a) If the interdependent lamp system providing the rear position lamp is partly mounted on the fixed component and partly mounted on a movable component, the interdependent lamp(s) specified by the applicant shall meet the outboard geometric visibility colorimetric and photometric requirement, at all fixed positions of the movable component(s). In this case, the inboard geometric visibility requirement is deemed to be satisfied if this (these) interdependent lamp(s) still conform to the photometric values prescribed in the field of light distribution for the approval of the device, at all fixed positions of the moveable component(s);
- (b) If the interdependent lamp system providing the rear direction indicator function is partly mounted on the fixed component and partly mounted on a movable component, the interdependent lamp(s) specified by the applicant shall meet the geometric visibility, colorimetric and photometric requirement, at all fixed positions of the movable component(s). This does not apply to interdependent direction indicator lamp(s) intended for fitting on vehicle(s) where, to fulfil or complete the geometric visibility angle, additional lamps are activated when the movable component is in any fixed open position, provided that these additional lamps satisfy all the position,

photometric and colorimetric requirements applicable to the direction indicator lamps installed on the movable component.

- 4.8.5 The provisions of the relevant paragraphs of Annex 3 on local variations of intensity must be observed.
- 4.8.6. If not otherwise specified, the intensities shall be measured with the light source continuously alight and, in the case of lamps emitting red light, in coloured light.
- 4.8.7. In the case of lamps of categories R2, RM2, S2, S4, F2 and 2b, the time that elapses between energising the light source(s) and the light output measured on the reference axis to reach 90 per cent of the value measured in accordance with paragraph 5. shall be measured for the extreme levels of luminous intensity produced by the lamp. The time measured to obtain the lowest luminous intensity shall not exceed the time measured to obtain the highest luminous intensity.
- 4.8.8. The variable intensity control shall not generate signals which cause luminous intensities:
- 4.8.8.1. Outside the range specified in paragraph 5.; and
- 4.8.8.2. Exceeding the respective steady luminous intensity maximum specified in paragraph 5. for the specific lamp:
- (a) For systems depending only on daytime and night time conditions: under night time conditions;
- (b) For other systems: under standard conditions<sup>1</sup>.
- 4.8.9 Particulars of the methods of measurement to be used are given in Annex 3.
- 4.8.10. If a rear position lamp and/or a rear end-outline marker lamp is reciprocally incorporated with a stop lamp producing either steady or variable luminous intensity, the ratio between the luminous intensities actually measured of the two lamps when turned on simultaneously at the intensity of the rear position lamp when turned on alone should be at least 5: 1 in the field delimited by the straight horizontal lines passing through  $\pm 5^\circ$  V and the straight vertical lines passing through  $\pm 10^\circ$  H of the light distribution table.
- If the rear position lamp or the stop lamp or both contain(s) more than one light source and is (are) considered as a single lamp, the values to be considered are those obtained with all sources in operation;
- 4.9 COLOUR OF LIGHT EMITTED

The colour of the light emitted shall be measured inside the field of the light distribution grid defined for the specific function in the relevant paragraph of Annex 3. To check these colorimetric characteristics, the test procedure described in paragraph 4.7. shall be applied. Outside this field no sharp variation of colour shall be observed.

---

<sup>1</sup> Good visibility (meteorological optical range MOR > 2,000 m defined according to WMO, Guide to Meteorological Instruments and Methods of Observation, Sixth Edition, ISBN: 92-63-16008-2, pp 1.9.1/1.9.11, Geneva 1996) and clean lens.

However, for lamps equipped with non-replaceable light sources, the colorimetric characteristics should be verified with the light sources present in the lamp, in accordance with relevant subparagraphs of paragraph 4.7.

## 5. Specific technical requirements

### 5.1 TECHNICAL REQUIREMENTS CONCERNING FRONT POSITION LAMPS, (SYMBOLS A,) AND FRONT END-OUTLINE MARKER LAMPS, (SYMBOLS AM)

5.1.1. The light emitted by each of the two lamps supplied shall meet the requirements in table 3.

Table 3: Luminous intensities for front position and front end-outline marker lamps

	<i>Minimum luminous intensity in HV (values in cd)</i>	<i>Maximum luminous intensity in any direction when used as (values in cd)</i>	
		<i>A single lamp</i>	<i>A lamp marked "D" (paragraph 3.3.2.5.2.)</i>
Front position lamps, front end-outline marker lamp, A or AM	4	140	70
Front position lamps (motorcycle), MA	4	140	N.A.
Front position lamps A incorporated in a headlamp or in a front fog lamp	4	140	N.A.

5.1.2. Outside the reference axis and within the angular fields defined in the diagrams in Part A of Annex 2, the intensity of the light emitted by each lamp must in each direction corresponding to the points in the table of standard light distribution reproduced in paragraph 2. of Annex 3, be not less than the minimum specified in paragraph 5.1.1., multiplied by the percentage specified in the said table of the direction in question.

5.1.3. Throughout the fields defined in the diagrams in Part A of Annex 2, the luminous intensity of the light emitted must be not less than 0.05 cd for front position lamps and front end-outline marker lamps;

5.1.4. The colour of the light emitted shall be white.

### 5.2 TECHNICAL REQUIREMENTS CONCERNING REAR POSITION LAMPS (SYMBOLS R1, R2, MR) AND REAR END-OUTLINE MARKER LAMPS (SYMBOLS RM1, RM2)

5.2.1. The light emitted by each of the two lamps supplied shall meet the requirements in table 4.

Table 4: Luminous intensities for rear position and rear end-outline marker lamps

	<i>Minimum luminous intensity in H-V (values in cd)</i>	<i>Maximum luminous intensity in any direction when used as (values in cd)</i>	
		<i>A single lamp</i>	<i>A lamp marked "D" (paragraph 3.3.2.5.2.)</i>
Rear position lamps, rear end-outline marker lamp			
R1 or RM1 (steady)	4	17	8.5
MR	4	17	N.A.
R2 or RM2 (variable)	4	42	21

5.2.2. Outside the reference axis and within the angular fields defined in the diagrams in Part A of Annex 2, the intensity of the light emitted by each lamp must in each direction corresponding to the points in the table of standard light distribution reproduced in paragraph 2. of Annex 3, be not less than the minimum specified in paragraph 5.2.1., multiplied by the percentage specified in the said table for the direction in question.

5.2.3. However, a luminous intensity of 60 cd shall be permitted for rear position lamps reciprocally incorporated with stop lamps below a plane forming an angle of 5° with and downward from the horizontal plane;

5.2.4. Throughout the fields defined in the diagrams in Part A of Annex 2, the luminous intensity of the light emitted must be not less than 0.05 cd for rear position lamps and end-outline marker lamps,

5.2.5. The colour of light emitted shall be red.

This requirement shall also apply within the range of variable luminous intensity produced by:

- (a) Rear position lamps of category R2;
- (b) Rear end-outline marker lamps of category RM2.

### 5.3. TECHNICAL REQUIREMENTS CONCERNING PARKING LAMPS (SYMBOL 77R)

5.3.1. The light emitted by each of the two lamps supplied shall meet the requirements in table 5.

Table 5: Luminous intensities for parking lamps

	<i>Minimum luminous intensity in H-V (values in cd)</i>	<i>Maximum luminous intensity in any direction (values in cd)</i>
forward facing parking lamps	2	60
rearward facing parking lamps	2	30

5.3.2. However, a luminous intensity of 60 cd shall be permitted for parking lamps directed to the rear incorporated with stop lamps below a plane forming an angle of 5° with and downward from the horizontal plane.

- 5.3.3. Outside the reference axis and within the angular fields defined in the diagrams in Part A of Annex 2, the intensity of the light emitted by each lamp shall, in each direction corresponding to the points in the table of standard light distribution reproduced in paragraph 2. of Annex 3, be not less than the minimum specified in paragraph 5.3.1., multiplied by the percentage specified in the said table for the direction in question.
- 5.3.4. Throughout the fields defined in the diagrams in Part B of Annex 2, the luminous intensity of the light emitted must be not less than 0.05 cd for front and rear parking lamps;
- 5.3.5. The colour of light emitted shall:
- For forward facing parking lamps be white;
  - For rearward facing parking lamps be red;
  - For side facing parking lamps be amber.

5.4. TECHNICAL REQUIREMENTS CONCERNING DAYTIME RUNNING LAMPS (SYMBOLS RL)

- 5.4.1. The light emitted by each of the two lamps supplied shall meet the requirements in table 6.

Table 6: Luminous intensities for daytime running lamps

	<i>Minimum luminous intensity in H-V (values in cd)</i>	<i>Maximum luminous intensity in any direction (values in cd)</i>
Daytime running lamps	400	1200

- 5.4.2. Outside the reference axis the intensity of the light emitted by each lamp must, in each direction corresponding to the points in the table of standard light distribution reproduced in paragraph 2. of Annex 3, be not less than the minimum specified in paragraph 5.4.1., multiplied by the percentage specified in the said table of the direction in question.
- 5.4.3. Moreover, throughout the field defined in the diagram in Part A of Annex 2, the intensity of the light emitted shall not be less than 1.0 cd.
- 5.4.4. Light source failure
- 5.4.4.1. In the case of a daytime running lamp containing more than one light source, the daytime running lamp shall comply with the minimum intensity required and the maximum intensity shall not be exceeded when all light sources are activated.
- 5.4.4.2. In case of failure of any one light source in a single lamp containing more than one light source, one of the following provisions shall apply:
- The light intensity at the points of standard light distribution defined in paragraph 2.1. of Annex 3 shall be at least 80 per cent of the minimum intensity required; or
  - The light intensity in the axis of reference shall be at least 50 per cent of the minimum intensity required, provided that a note in the communication form states that the lamp is only for use on a vehicle fitted with an operating tell-tale.

- 5.4.5. The colour of the light emitted shall be white.
- 5.4.6. The area of the apparent surface in the direction of the axis of reference of the daytime running lamp shall be not less than 25 cm<sup>2</sup> and not more than 200 cm<sup>2</sup>.
- 5.4.7. The daytime running lamp shall be subjected to the heat resistance test specified in Annex 6.
- 5.5 TECHNICAL REQUIREMENTS CONCERNING STOP LAMPS  
(SYMBOLS S1, S2, S3, S4, MS)
- 5.5.1. The light emitted by each of the two lamps supplied shall meet the requirements in table 7.

Table 7: Luminous intensities for stop lamps

Stop lamp of category	Minimum luminous intensity in H-V (values in cd)	Maximum luminous intensity in any direction when used as (values in cd)	
		A single lamp	A lamp marked "D" (paragraph 3.3.2.5.2.)
S1 (steady)	60	260	130
S2 (variable)	60	730	365
S3 (steady)	25	110	55
S4 (variable)	25	160	80
MS (steady)	40	260	N.A.

- 5.5.2. Outside the reference axis the intensity of the light emitted by each lamp shall, in each direction corresponding to the points in the table of standard light distribution reproduced in paragraph 2. of Annex 3 be not less than the minimum specified in paragraph 5.5.1., multiplied by the percentage specified in the said table of the direction in question.
- 5.5.3. Throughout the fields defined in the diagrams in Part A of Annex 2, the luminous intensity of the light emitted shall be not less than 0.3 cd for devices of categories S1, S3 and for those of categories S2 and S4 by day; it shall not be less than 0.07 cd for devices of categories S2 and S4 by night.
- 5.5.4. The colour of the light emitted shall be red.
- In the case of a category S3 or S4 stop lamp, which is intended to be mounted inside the vehicle, the colorimetric characteristics shall be verified with the worst case combination(s) of lamp and rear window(s) or sample plate(s).
- These requirements shall also apply within the range of variable luminous intensity produced by stop lamps of categories S2 and S4.
- 5.6. TECHNICAL REQUIREMENTS CONCERNING DIRECTION-INDICATOR LAMPS (Symbols 1, 1a, 1b, 2a, 2b, 5, 6, 11, 11a, 11b, 11c, 12)
- 5.6.1. The light emitted by each of the two lamps supplied shall meet the requirements in table 8 where the minimum luminous intensities shall be fulfilled:
- (a) In the case of direction indicators of categories 1, 1a, 1b, 2a, 2b, 11, 11a, 11b, 11c and 12 in the reference axis; or

- (b) in the case of direction indicators of categories 5 and 6 in direction A according to Annex 2.

Table 8: Luminous intensities for direction indicator lamps

Direction indicator lamp of category	Minimum luminous intensity (values in cd)	Maximum luminous intensity in any direction when used as (values in cd)	
		A single lamp	A lamp marked "D" (paragraph 3.3.2.5.2.)
1	175	1000	500
1a	250	1200	600
1b	400	1200	600
2a (steady)	50	500	250
2b (variable)	50	1000	500
5	0.6	280	140
6	50	280	140
11	90	1000	N.A.
11a	175	1000	N.A.
11b	250	1200	N.A.
11c	400	1200	N.A.
12	50	500	N.A.

- 5.6.2. Outside the reference axis the intensity of the light emitted by each lamp shall, in each direction corresponding to the points in the table of standard light distribution reproduced in:

- (a) Paragraph 2.1. of Annex 3 for categories 1, 1a, 1b, 2a, 2b, 11, 11a, 11b, 11c and 12.; or  
 (b) Paragraph 2.4. of Annex 3 for category 6.

Be not less than the minimum specified in paragraph 5.6.1., multiplied by the percentage specified in the said table of the direction in question.

- 5.6.3. Failure provisions

For direction-indicator lamps of categories 1, 1a,1b, 2a, 2b, 11, 11a, 11b, 11c and 12 a signal for activation of the tell-tale prescribed in paragraph 6.5.8. of Regulation No. 48 or paragraph 6.3.8. of Regulation No. 53 shall be produced if (notwithstanding the provisions stated in paragraph 4.6.):

- (a) Any one light source has failed; or  
 (b) In the case of a lamp designed for only two light sources, the intensity in the axis of reference is less than 50 per cent of the minimum intensity; or  
 (c) As a consequence of a failure of one or more light sources, the intensity in one of the following directions as indicated in paragraph 2.1. of Annex 3, is less than the minimum intensity required:  
 (i)  $H=0^\circ, V=0^\circ$



(ii)  $H=20^\circ$  to the outside of the vehicle,  $V=+5^\circ$

(iii)  $H=10^\circ$  to the inside of the vehicle,  $V=0^\circ$ .

5.6.4. Test procedure:

In divergence from paragraphs 4.8.2.4. and 4.8.2.4.1., for category 5 direction indicators, to the rear, a minimum value of 0.6 cd is required throughout the fields specified in Part A of Annex 2;

5.6.5. Throughout the fields defined in the diagrams in Part A of Annex 2, the intensity of the light emitted shall be not less than 0.7 cd for lamps of category 1b, not less than 0.3 cd for lamps of categories 1, 1a, 2a, 11, 11a, 11b, 11c, 12 and for those of category 2b by day; it shall not be less than 0.07 cd for lamps of category 2b by night;

5.6.6. In general, the intensities shall be measured with the light source(s) continuously alight.

However, depending on the construction of the lamp, for example, the use of light-emitting diodes (LED), or the need to take precautions to avoid overheating, it is allowed to measure the lamps in flashing mode.

(a) This shall be achieved by switching with a frequency of  $f = 1.5 \pm 0.5$  Hz with the pulse width greater than 0.3 s, measured at 95 per cent peak light intensity. In all other cases the voltage as required in paragraph 4.7.1. shall be switched with a rise time and fall time shorter than 0.01 s; no overshoot is allowed;

(b) In the case of measurements taken in flashing mode the reported luminous intensity shall be represented by the maximum intensity.

5.6.7. In the case of lamps of category 2b the time that elapses between energizing the light source(s) and the light output measured on the reference axis to reach 90 per cent of the value measured in accordance with paragraph 5.6.2. shall be measured for the extreme levels of luminous intensity produced by the direction indicator. The time measured to obtain the lowest luminous intensity shall not exceed the time measured to obtain the highest luminous intensity.

5.6.8. The variable intensity control shall not generate signals which cause luminous intensities outside the range specified in paragraph 5.6.1. and exceeding the category 2a maximum specified in paragraph 5.6.1.:

(a) For systems depending only on daytime and night time conditions: under night time conditions;

(b) For other systems: under reference conditions as demonstrated by the manufacturer.<sup>2</sup>

5.6.9. The colour of the light emitted shall be amber. This requirement shall also apply within the range of variable luminous intensity produced by rear direction indicator lamps of category 2b.

<sup>2</sup> Good visibility (meteorological optical range MOR > 2,000 m defined according to WMO, Guide to Meteorological Instruments and Methods of Observation, Sixth Edition, ISBN: 92-63-16008-2, pp 1.9.1/1.9.11, Geneva 1996) and clean lens.

- 5.6.10. For any direction indicator lamp except those equipped with filament light source(s), the luminous intensities measured after one minute and after 30 minutes of operation in flashing mode ( $f = 1.5$  Hz, duty factor 50 per cent), shall comply with the minimum and maximum requirements. The luminous intensity distribution after one minute of operation can be calculated by applying at each test point the ratio of luminous intensity measured in HV after one minute and after 30 minutes of operation as above described.
- 5.6.11. For direction indicator lamps of categories 1, 1a, 1b, 2a or 2b the flash may be produced by sequential activation of their light sources if the following conditions are met:
- Each light source, after its activation, shall remain lit until the end of the ON cycle;
  - The sequence of activation of the light sources shall produce a signal which proceeds in a uniform progressive manner from inboard towards the outboard edge of the light emitting surface;
  - It shall be one signal with no interruption and no vertical oscillations (e.g. not more than one change of direction along the vertical axis). The distance between two adjacent/tangential distinct parts of the light emitting surface of the sequential direction indicator shall not exceed 50mm, when measured perpendicularly to the reference axis, instead of the values defined in paragraph 5.7.2. of UN Regulation 48. These interruptions of the signal shall not create any overlap in the vertical axis between the different parts, from inboard towards the outboard of the vehicle, and shall not be used for any other lighting or light signalling functions;
  - The variation shall finish no more than 200ms after the beginning of the ON cycle;
  - The orthogonal projection of the light emitting surfaces of the direction indicator in the direction of the axis of reference shall be circumscribed by a rectangle on a plane normal to the axis of reference and having its longer sides parallel to the H-plane. The ratio of the horizontal to the vertical sides shall not be less than 1.7.

Compliance to the conditions mentioned above shall be verified in flashing mode.

#### 5.7. TECHNICAL REQUIREMENTS CONCERNING SIDE MARKER LAMPS (SYMBOLS SM1, SM2)

- 5.7.1. The light emitted by each of the two lamps supplied shall meet the requirements in table 9.

Table 9: Luminous intensities for side marker lamps

Side marker lamp of category		SM1	SM2
Minimum intensity	In the axis of reference	4.0 cd	0.6 cd
	Within the specified angular field, other than above	0.6 cd	0.6 cd
Maximum intensity	Within the specified angular field <sup>1</sup>	25.0 cd	25.0 cd
Angular field	Horizontal	±45 deg.	±30 deg.

Side marker lamp of category	SM1	SM2
Vertical	±10 deg.	±10 deg.

In addition, for red side marker lamp, in the angular field from 60° to 90° in horizontal direction and ±20° in vertical direction towards the front of the vehicle, the maximum intensity is limited to 0.25 cd.

5.7.2. Outside the reference axis and within the angular fields defined in the diagrams in Part C of Annex 2, the intensity of the light emitted by each of the two side marker lamps supplied shall:

- (a) In each direction corresponding to the points in the light distribution table reproduced in paragraph 2.7. of Annex 3, be not less than the product of the minimum specified in paragraph 5.7.1. by the percentage specified in the said table for the direction in question;
- (b) In no direction within the space from which the side marker lamp is visible, exceed the maximum specified in paragraph 5.7.1..

5.7.3. For SM1 and SM2 categories of side marker lamps it may be sufficient to check only five points selected by the Type Approval Authority.

5.7.4. The colour of the light emitted shall be amber. However, it can be red, if the rearmost side marker lamp is grouped or combined or reciprocally incorporated with the rear position lamp, the rear end-outline marker lamp, the rear fog lamp, the stop lamp, or is grouped with or has part of the light emitting surface in common with the rear retro-reflector.

#### 5.8. TECHNICAL REQUIREMENTS CONCERNING REVERSING LAMPS (SYMBOLS AR)

5.8.1. The light emitted by each of the two lamps supplied shall meet the requirements in table 10.

Table 10: Luminous intensities for reversing lamps

	<i>Minimum luminous intensity in H-V (values in cd)</i>	<i>Maximum luminous intensity in any direction (values in cd)</i>		
		in or above the h plane	below the h plane, down to 5°D	below 5°D
Reversing lamps	80	300	600	8000

5.8.2. In every other direction of measurement shown in paragraph 2.5. of Annex 3, the luminous intensity shall be not less than the minima specified in that annex.

However, in the case where the reversing lamp is intended to be installed on a vehicle exclusively in a pair of devices, the photometric intensity may be verified only up to an angle of 30° inwards where a photometric value of at least 25 cd shall be satisfied.

This condition shall be clearly explained in the application for approval and relating documents (see paragraph 3.1.).

Moreover, in the case where the type approval will be granted applying the condition above, a statement in paragraph 9.1.3. of the communication form (see Annex 1) will inform that the device shall only be installed in a pair.

5.8.3 The colour of the light emitted shall be white.

5.9 TECHNICAL REQUIREMENTS CONCERNING REAR FOG LAMPS (SYMBOLS F1, F2)

5.9.1. The light emitted by each of the two lamps supplied shall meet the requirements in table 11.

Table 11: Luminous intensities for rear fog lamps

<i>Rear fog lamps of category</i>	<i>Minimum luminous intensity in HV (values in cd)</i>	<i>Maximum luminous intensity in any direction (values in cd)</i>
F1 (steady)	150	300
F2 (variable)	150	840

5.9.2. The light intensity at the points of standard light distribution is defined in Paragraph 2.6. of Annex 3

5.9.3. The variable intensity control shall not generate signals which cause luminous intensities outside the range specified in paragraph 5.9.1. and exceeding the category F1 maximum specified in paragraph 5.9.1.:

- (a) For systems depending only on daytime and night time conditions: under night time conditions;
- (b) For other systems: under standard conditions<sup>3</sup>

5.9.4. The apparent surface in the direction of the reference axis shall not exceed 140 cm<sup>2</sup>.

5.9.5. The colour of the light emitted shall be red.

5.9.6. The rear fog lamp shall be subjected to the test specified in Annex 6.

5.10. TECHNICAL REQUIREMENTS CONCERNING MANOEUVRING LAMPS (SYMBOLS ML)

5.10.1. The intensity of light emitted shall not exceed 500 cd in all directions in which the light can be observed, when installed in any mounting position specified by the applicant.

5.10.2. The lamp must be so designed that the light emitted directly towards the side, the front or the rear of the vehicle does not exceed 0.5 cd within the angular field as defined below.

- (a) The vertical minimum angle  $\varphi_{\min}$  (in degrees) is:  

$$\varphi_{\min} = \arctan (1\text{-mounting height})/10$$
; where h is mounting height in m
- (b) The vertical maximum angle  $\varphi_{\max}$  (in degrees) is:  $\varphi_{\max} = \varphi_{\min} + 11.3$

<sup>3</sup> Good visibility (meteorological optical range MOR > 2,000 m defined according to WMO, Guide to Meteorological Instruments and Methods of Observation, Sixth Edition, ISBN: 92-63-16008-2, pp .9.1/1.9.11, Geneva 1996.) and clean lens.

The measurement shall be limited to a horizontal angle ranging from +90° to -90° with respect to the line which cuts the reference axis and which is perpendicular to the vertical longitudinal plane of the vehicle.

The measurement distance shall be 3.0 m minimum.

5.10.3. The colour of the light emitted shall be white.

5.11. TECHNICAL REQUIREMENTS CONCERNING REAR-REGISTRATION PLATE ILLUMINATING LAMPS (SYMBOL L, LM1)

5.11.1. The devices for the illumination of rear-registration plates of category L shall be so constructed that the whole surface of the plate will be visible within the angles given in Part D of Annex 2.

5.11.2. Measuring procedure

However, the luminance measurements shall be made on a diffuse colourless surface with known diffuse reflection factor<sup>4</sup>. The diffuse colourless surface shall have the dimensions of the registration plate or the dimension exceeding one measuring point. Its centre shall be placed in the centre of the positions of the measuring points.

This (These) diffuse colourless surface(s) shall be placed in the position normally occupied by the registration plate and 2 mm in front of its holder.

Luminance measurements shall be made perpendicularly to the surface of the diffuse colourless surface with the tolerance of 5° in each direction at the points shown in paragraph 3. of Annex 3, each point representing a circular area of 25 mm in diameter. The measured luminance shall be corrected for the diffuse reflection factor 1.0.

5.11.3. Photometric characteristics

At each of the points of measurement shown in paragraph 3. of Annex 3, the luminance B shall be at least

(a) For categories L equal to 2.5 cd/m<sup>2</sup>;

(b) For categories LM1 equal to 2.0 cd/m<sup>2</sup>.

The gradient of the luminance between the values B<sub>1</sub> and B<sub>2</sub>, measured at any two points 1 and 2 selected from among those mentioned above, shall not exceed 2 x B<sub>0</sub>/cm, B<sub>0</sub> being the minimum luminance measured at the various points, i.e.:

$$\frac{B_2 - B_1}{\text{distance 1-2 in cm}} \leq 2 \times B_0/\text{cm}$$

5.11.4. The colour of the light emitted shall be sufficiently colourless not to cause any appreciable change in the colour of the registration plate.

5.11.5. Incidence of the light

The manufacturer of the illuminating device shall specify one or more or a field of positions in which the device is to be fitted in relation to the space for the registration plate; when the lamp is placed in the position(s) specified by the manufacturer the angle of incidence of the light on the surface of the plate

<sup>4</sup> CIE Publication No.17 –1970, paragraph 45-20-040.

does not exceed 82° at any point on the surface to be illuminated, this angle being measured from the extremity of the device's illuminating area which is furthest from the surface of the plate. If there is more than one illuminating device, the foregoing requirement shall apply only to that part of the plate intended to be illuminated by the device concerned.

When the device has one outer edge of the illuminating surface that is parallel to the surface of the registration plate, the extremity of the illuminating surface of the device which is furthest from the surface of the plate is the middle point of the edge of the illuminating surface, which is parallel to the plate and is furthest from the surface of the plate.

The device must be so designed that no light is emitted directly towards the rear, with the exception of red light if the device is combined or grouped with a rear lamp.

**Annex 1**

**Communication**

(Maximum format: A4 (210 x 297 mm))

	issued by:	Name of Administration: ..... ..... ..... .....
	Concerning <sup>2</sup> :	Approval granted Approval extended Approval refused Approval withdrawn Production definitively discontinued
of a type of lamp pursuant to LSD Regulation No.[XX]		
Lamp <sup>2</sup> :	Rear-registration plate illuminating lamp Direction indicator Stop lamp Position lamp End-outline marker lamp Reversing lamp Manoeuvring lamp Rear fog lamp Parking lamp Daytime running lamp Side marker lamp	for a vehicle / vehicle class L
Category of the device		/
Approval No:	Extension No:	
Unique Identifier (UI) (If applicable)		

1. Trade name or mark of the lamp: .....

<sup>1</sup> Distinguishing number of the country which has granted/extended/refused/withdrawn approval (see approval provisions in this UN Regulation).

<sup>2</sup> Strike out what does not apply.

2. Manufacturer's name for the type of lamp: .....
3. Manufacturer's name and address: .....
4. If applicable, name and address of the manufacturer's representative: .....  
.....
5. Submitted for approval on: .....
6. Technical Service responsible for conducting approval tests: .....
7. Date of report issued by that Service: .....
8. Number of report issued by that Service: .....
9. Concise description:
  - 9.1. In case of
    - 9.1.1. A rear-registration plate illuminating lamp: .....  
Geometrical conditions of installation (position(s) and inclination(s) of the device in relation to the space to be occupied by the registration plate and/or different inclinations of this space): .....
    - 9.1.2. A direction indicator: .....  
Sequential activation of light sources: yes/no<sup>2</sup>
    - 9.1.3. A reversing lamp:  
The lamp shall be installed on a vehicle only as part of a pair of lamps: yes/no<sup>2</sup>
    - 9.1.4. A manoeuvring lamp:  
The maximum mounting height: .....
  - 9.2. By light signalling function and category:  
For mounting either outside or inside or both<sup>2</sup>  
Colour of light emitted: red/white/amber/colourless<sup>2</sup>  
Number, category and kind of light source(s): .....  
Voltage and wattage: .....  
Light source module: yes/no<sup>2</sup>  
Light source module specific identification code: .....  
Only for installation on M<sub>1</sub> and/or N<sub>1</sub> category vehicles: yes/no<sup>2</sup>  
Only for limited mounting height of equal to or less than 750 mm above the ground, if applicable: yes/no<sup>2</sup>.....  
Geometrical conditions of installation and relating variations, if any: .....  
Application of an electronic light source control gear/variable intensity control:
    - (a) Being part of the lamp: yes/no<sup>2</sup>
    - (b) Being not part of the lamp: yes/no<sup>2</sup>
 Input voltage(s) supplied by an electronic light source control gear/variable intensity control: .....



Electronic light source control gear/variable intensity control manufacturer and identification number (when the light source control gear is part of the lamp but is not included into the lamp body): .....

Variable luminous intensity, if applicable: yes/no<sup>2</sup>

Function(s) produced by an interdependent lamp forming part of an interdependent lamp system, if applicable: .....

10. Position of the approval mark: .....

11. Reason(s) for extension (if applicable): .....

.....

12. Approval granted/extended/refused/withdrawn<sup>2</sup>: .....

13. Approval granted for devices to be used on vehicles already in use only, yes/no<sup>2</sup>

14. Place: .....

15. Date: .....

16. Signature: .....

17. The list of documents deposited with the Type Approval Authority which has granted approval is annexed to this communication and may be obtained on request.

.....  
.....  
.....  
.....  
.....

## Annex 2

### Light distribution in space, horizontal and vertical

The angles shown in these arrangements are correct for lamps to be mounted on the right side of the vehicle.

#### Part A: Position, end-outline marker, stop, front and rear direction indicators, daytime running and front and rear parking lamps

Figures A2-1: Light-distribution in space, horizontal and vertical

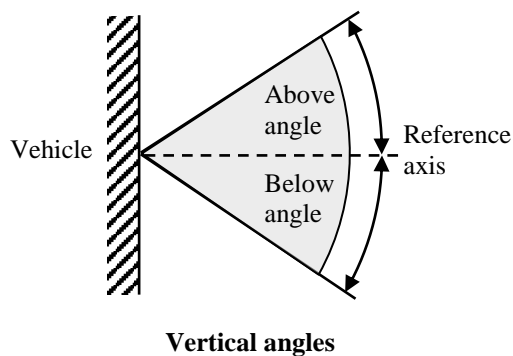
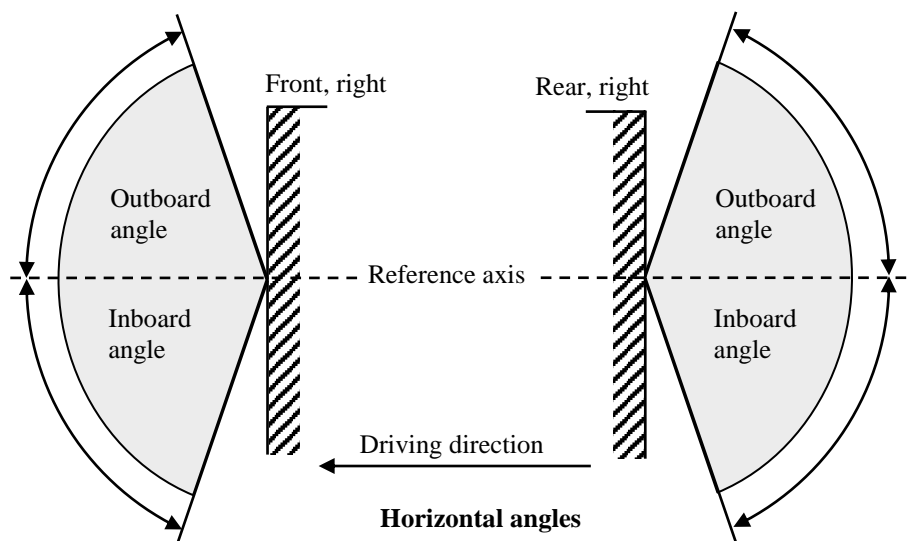

Table A2-1: Light-distribution in space, horizontal and vertical

<i>Lamp</i>	<i>Minimum horizontal angles (inboard / outboard)</i>	<i>Minimum vertical angles (above / below)</i>	<i>Additional information</i>
Front direction indicator (1, 1a, 1b)	45° / 80° 20° / 80° <sup>5</sup>	15° / 15° 15° / 5° <sup>1</sup>	-
Rear direction indicator (2a, 2b)	45° / 80° 20° / 80° <sup>5</sup>	15° / 15° 15° / 5° <sup>3</sup> 5° / 15° <sup>2</sup>	-
Front direction indicator (11, 11a, 11b, 11c) Rear direction indicator (12)	20° / 80°	15° / 15° 15° / 5° <sup>3</sup>	-
Front position singular (MA) Rear position singular (MR)	80° / 80°	15° / 10° 15° / 5° <sup>3</sup>	
Front position pair (MA) Rear position pair (MR)	20° / 80°	15° / 10° 15° / 5° <sup>3</sup>	
Stop (MS) Rear position (R, R1, R2)	45° / 45°	15° / 10° 15° / 5° <sup>3</sup>	
Front parking (77R) Rear parking (77R)	0° / 45°	15° / 15° 15° / 5° <sup>3</sup>	-
Front end-outline marker (AM) Rear end-outline marker (RM1, RM2)	0° / 80°	15° / 15° 15° / 5° <sup>3</sup> 5° / 15° <sup>4</sup>	-
Front position (A) Rear position (R, R1, R2)	45° / 80° 20° / 80° <sup>3</sup>	15° / 15° 15° / 5° <sup>3</sup> 5° / 15° <sup>4</sup>	-
Stop lamp (S1, S2)	45° / 45° 20° / 45° <sup>5</sup>	15° / 15° 15° / 5° <sup>3</sup> 5° / 15° <sup>4</sup>	
High mounted stop lamp (S3, S4)	10° / 10°	10° / 5°	-
Daytime running lamps (RL)	20° / 20°	10° / 5°	

<sup>1</sup> For lamps to be installed with the H-plane of the lamp at a mounting height of less than 750 mm.

<sup>2</sup> Optional lamps to be installed with the H-plane of the lamp at a mounting height of more than 2100 mm.

<sup>3</sup> Reduced angles used only below the H-plane for lamps mounted with the H-plane below 750 mm.

**Part B: Side direction indicators and side parking lamps<sup>4</sup>**

Figures A2-2: Light-distribution in space, horizontal and vertical

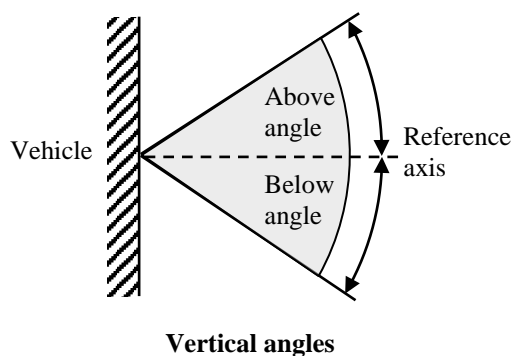
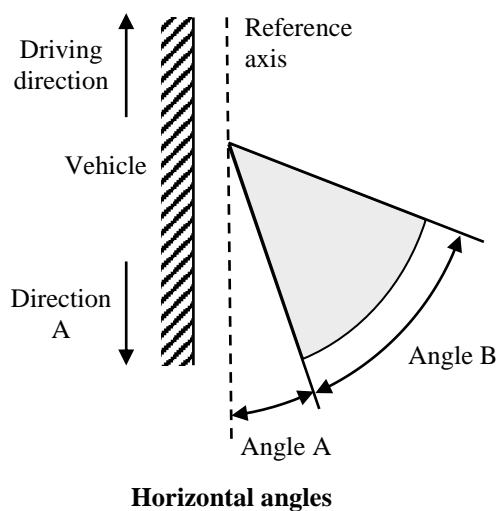

Table A2-2: Light-distribution in space, horizontal and vertical

<i>Lamp</i>	<i>Horizontal angles (A/B)</i>	<i>Min. vertical angles (above/below)</i>	<i>Additional information</i>
Side direction indicators (5)	5° / 55°	15° / 15° 15° / 5° <sup>3</sup>	-
Side direction indicators (6)	5° / 55°	30° / 5°	
Side parking <sup>6</sup>	Max. 0° / Min. 45°	15° / 15° 15° / 5° <sup>3</sup>	Horizontal angles apply to front and rear

<sup>4</sup> Side parking lamps are a combination of front and rear facing parking lamps.

**Part C: Side marker lamps**

Figures A2-3: Light-distribution in space, horizontal and vertical

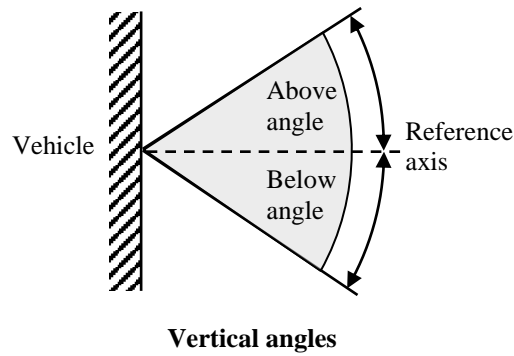
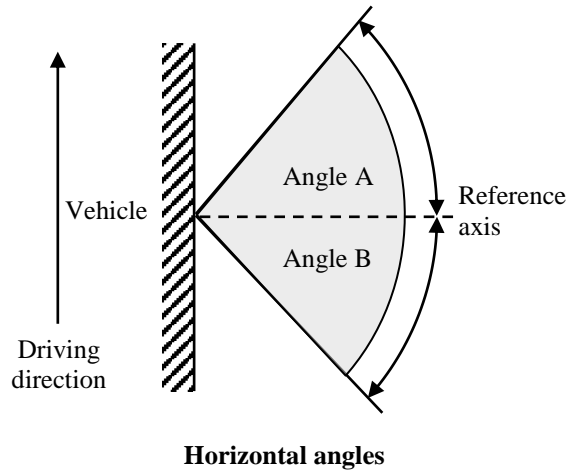

Table A2-3: Light-distribution in space, horizontal and vertical

<i>Lamp</i>	<i>Min. horizontal angles (A/B)</i>	<i>Min. vertical angles (above/below)</i>	<i>Additional information</i>
Side marker (SM1)	45° / 45°	10° / 10° 10° / 5° <sup>3</sup>	
Side marker (SM2)	30° / 30°	10° / 10° 10° / 5° <sup>3</sup>	

**Part D: Rear-registration plate illuminating lamp, field of visibility**

Figures A2-4: Light-distribution in space, horizontal and vertical

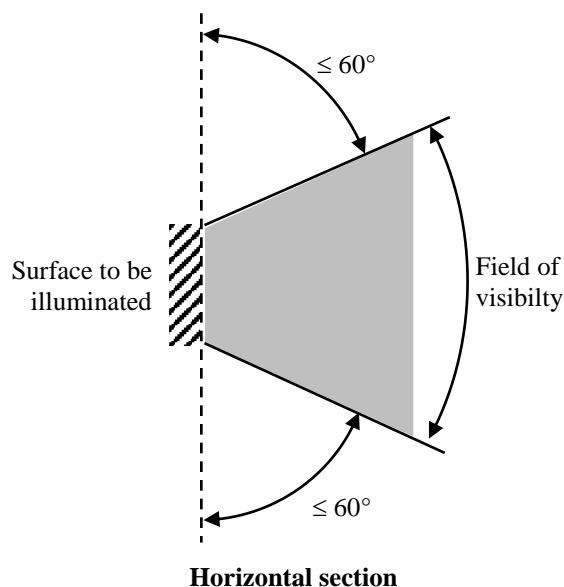
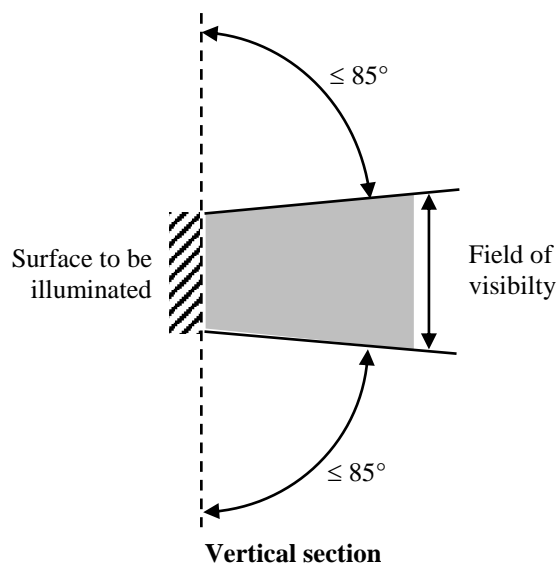

Table A2-4: Light-distribution in space, horizontal and vertical

<ol style="list-style-type: none"> <li>1. The field-of-visibility angles shown above relate only to the relative positions of the illuminating device and the space for the registration plate.</li> <li>2. The field of visibility of the registration plate when mounted on the vehicle remains subject to the relevant national regulations.</li> <li>3. The angles shown take account of the partial occultation caused by the illuminating device. They must be adhered to in the directions in which there is most occultation. The illuminating devices must be such as to reduce the areas partly occulted to the minimum strictly necessary.</li> </ol>
--

---

## Annex 3

### Standard light distributions

1. If not otherwise specified:
  - 1.1. The direction  $H = 0^\circ$  and  $V = 0^\circ$  corresponds to the reference axis. (On the vehicle, it is horizontal, parallel to the median longitudinal plane of the vehicle and oriented in the required direction of visibility.) It passes through the centre of reference. The values shown in figures A3-I to A3-XVI give, for the various directions of measurement, the minimum intensities as a percentage of the minimum intensities required.
  - 1.2. Within the field of light distribution schematically shown as a grid, the light pattern should be substantially uniform, i.e. the light intensity in each direction of a part of the field formed by the grid lines shall meet at least the lowest minimum value being shown on the grid lines surrounding the questioned direction as a percentage.
  - 1.3. However, in the case where one of the following lamps is intended to be installed at a mounting height (using the H plane specified by the manufacturer) equal to or less than 750 mm above the ground, the photometric intensity is verified only up to an angle of  $5^\circ$  downwards:
    - Front and rear direction indicators lamps;
    - Front and rear position lamps;
    - Front and rear end-outline marker lamps;
    - Parking lamps;
    - Stop lamps of category S1, S2 and MS;
    - Side marker lamps;
2. Standard light distribution.
  - 2.1. Standard light distribution for front and rear position lamps, parking lamps, front and rear end-outline marker lamps, stop lamps (S1, S2 and MS) and direction indicator lamps of categories 1, 1a, 1b, 2a, 2b, 11, 11a, 11b, 11c, 12.

Figure A3-I: Standard light distribution position-, parking-, end-outline marker-, stop- and direction indicator lamps

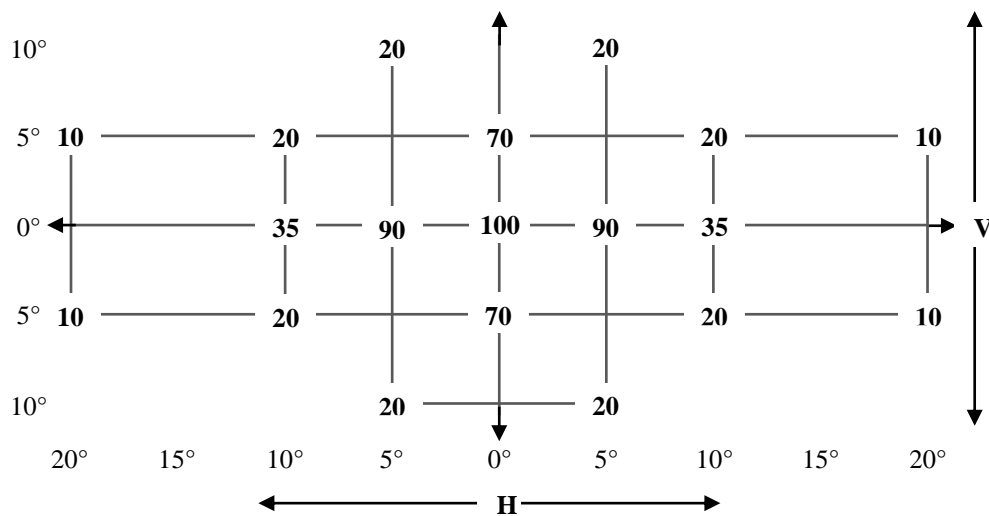

2.2. Standard light distribution for daytime running lamps

Figure A3-II: Light distribution for daytime running lamps

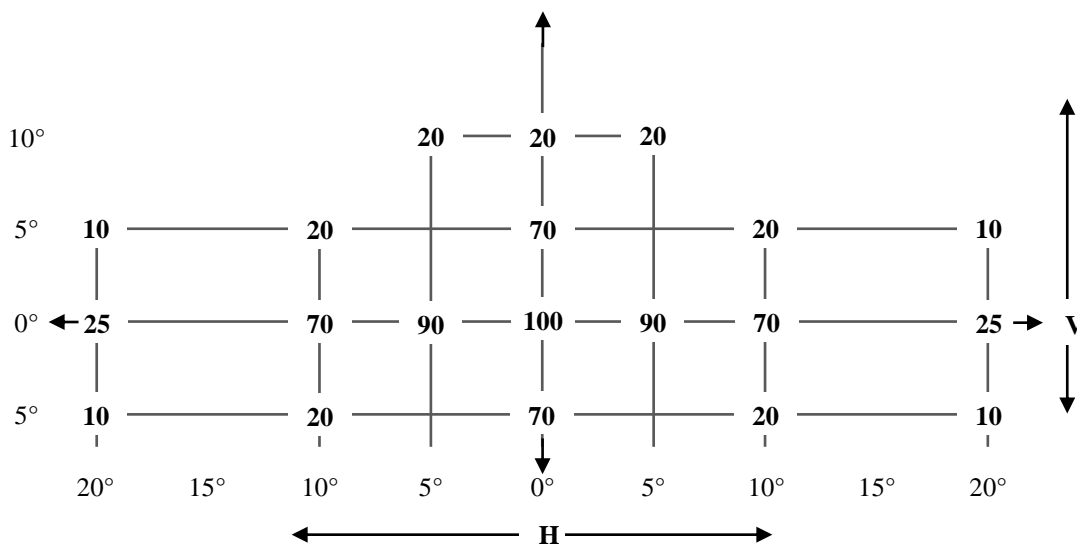



2.3. Standard light distribution for category S3 and S4 stop lamps

Figure A3-III: Light distribution for S3 and S4 stop lamps

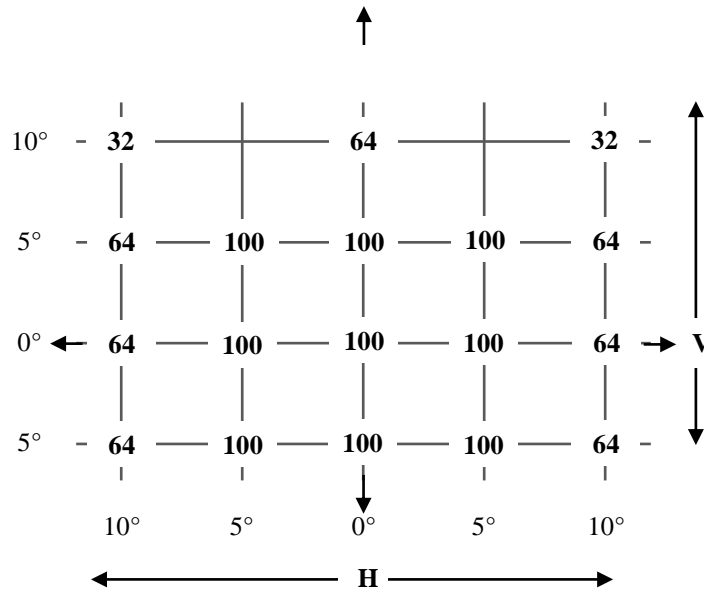

2.4. Standard light distribution for direction indicators lamps of category 6

The reference axis, H = 5° and V = 0°, corresponds to the direction A as prescribed in Annex 2

Figure A3-IV: Light distribution for direction indicator lamps category 6

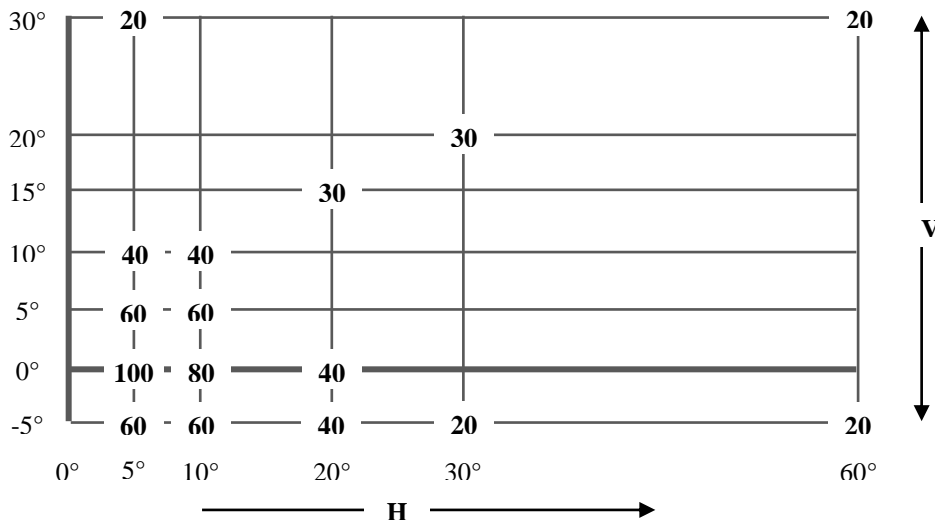

(outer side of the vehicle)

2.5. Standard light distribution for reversing lamps

The measuring points expressed in degrees of angle with the axis of reference and values of the minimum intensities of the light emitted.

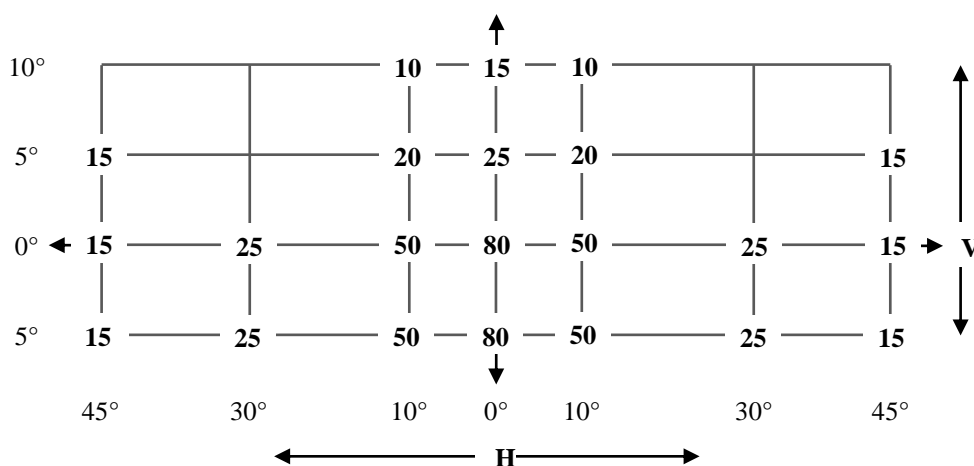

Figure A3-V: Light distribution for reversing lamps

The values inside figure A3-V are in cd.

The directions  $H = 0^\circ$  and  $V = 0^\circ$  correspond to the axis of reference. On the vehicle they are horizontal, parallel to the median longitudinal plane of the vehicle and oriented in the required direction of visibility. They pass through the centre of reference. The values shown in figure A3-V give, for the various directions of measurement, the minimum intensities in cd.

2.6. Standard light distribution for rear fog lamps

Figure A3-VI: Light distribution for rear fog lamps

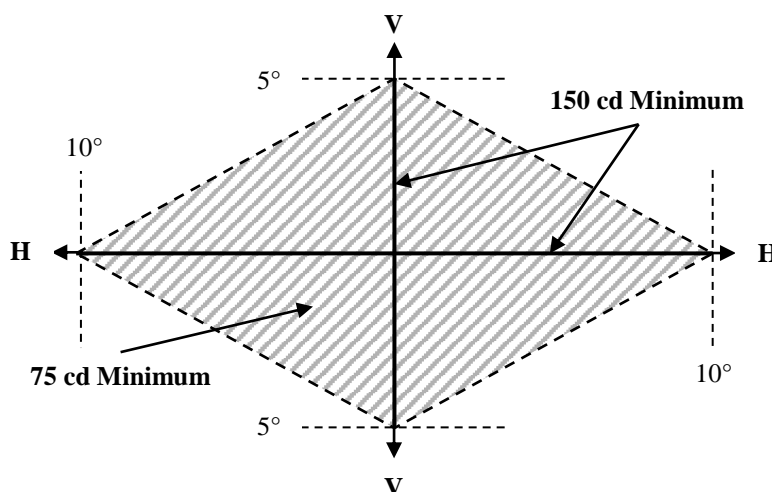

If visual examination of a light appears to reveal substantial local variations of intensity, a check shall be made to ensure that, outside the axes, no intensity measured within the rhombus defined by the extreme directions of measurement is below 75 cd (see diagram above).

2.7. Standard light distribution for side marker lamps

2.7.1. SM1 category of side marker lamps

Figure A3-VII: Light distribution for side marker lamps SM1

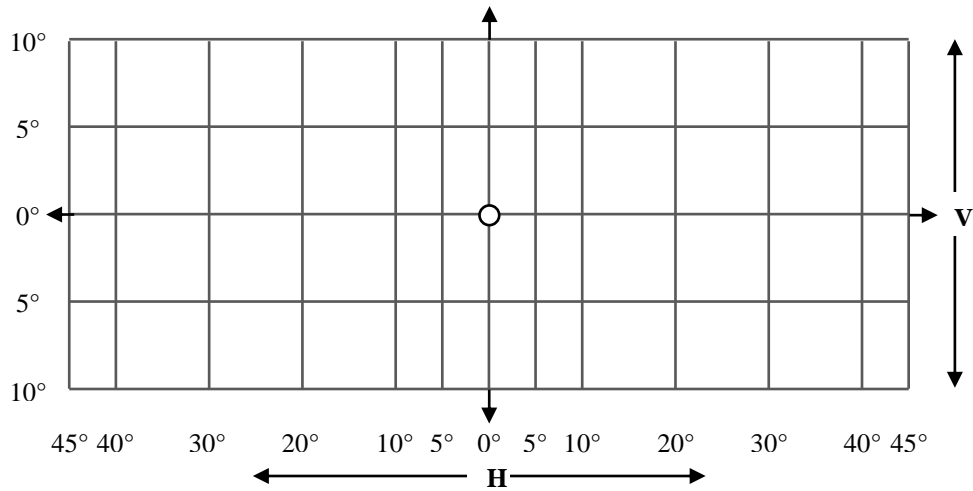

Minimum values: 0.6 cd at any point other than the reference axis, at which it shall be 4.0 cd  
 Maximum values: 25.0 cd at any point

2.7.2. SM2 category of side marker lamps

Figure A3-VIII: Light distribution for side marker lamps SM2

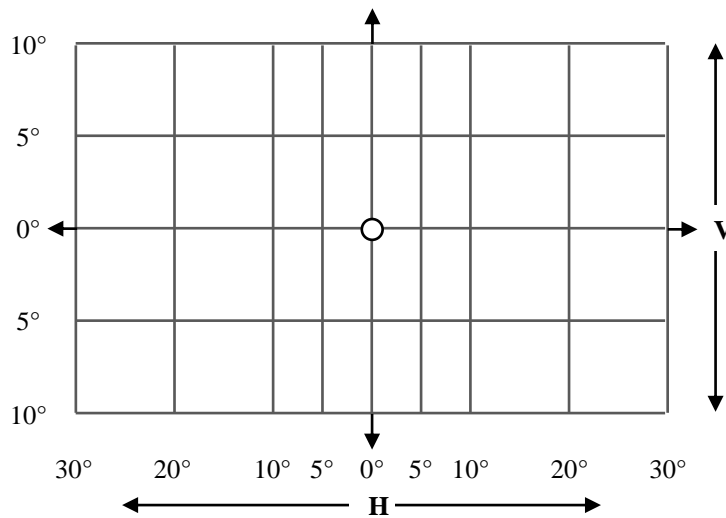

Minimum values: 0.6 cd at any point  
 Maximum values: 25.0 cd at any point

2.7.3. SM1 and SM2 category of side marker lamps

For SM1 and SM2 category of side marker lamps it may be sufficient to check only five points selected by the Type Approval Authority.

3. Measurement points for rear-registration plate illuminating lamps

3.1 Category 1a - tall plate (340 x 240 mm)

Figure A3-IX: Measuring points for plate size 340 x 240 mm

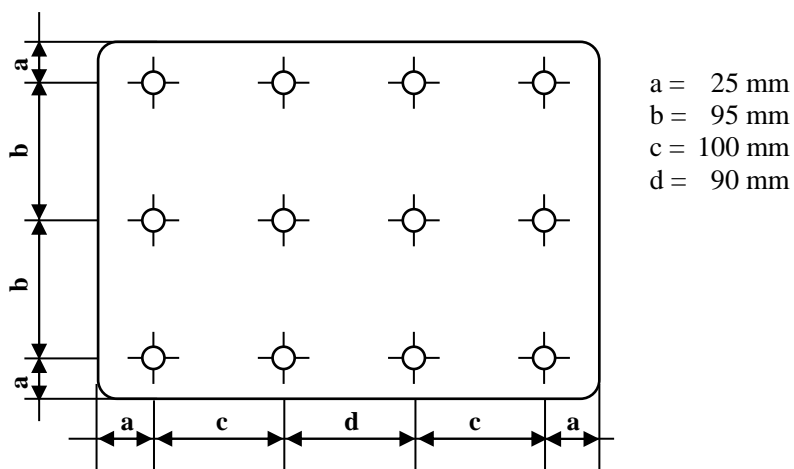

3.2 Category 1b - wide plate (520 x 120 mm)

Figure A3-X: Measuring points for plate size 520 x 120 mm

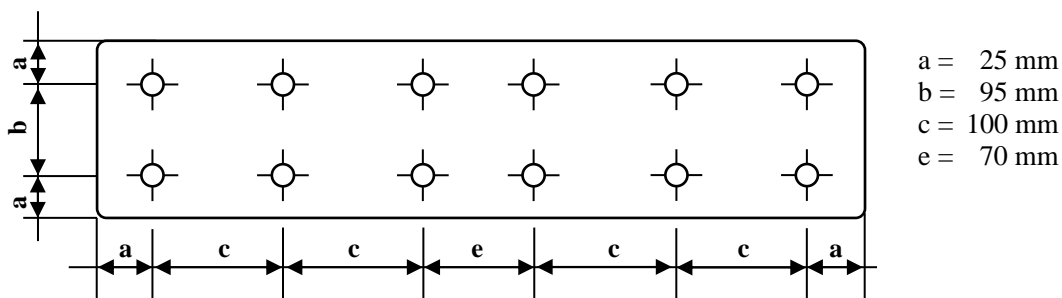

3.3. Category 1c - plate for agricultural or forestry tractors (255 x 165 mm)

Figure A3-XI: Measuring points for plate size 255 x 165 mm

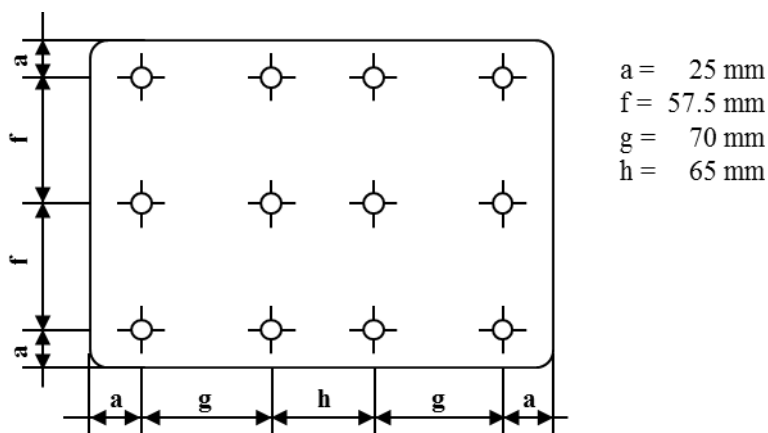

3.4. Category 2a – small plate (330 x 165 mm)

Figure A3-XII: Measuring points for plate size 330 x 165 mm

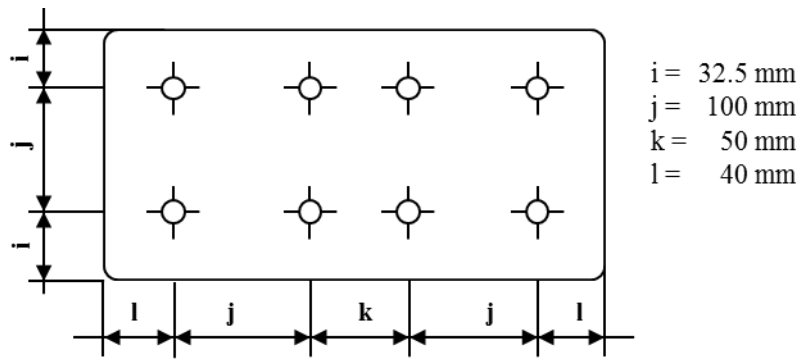

3.5. Category 2b – wide plate (440 x 220 mm)

Figure A3-XIII: Measuring points for plate size 440 x 220 mm

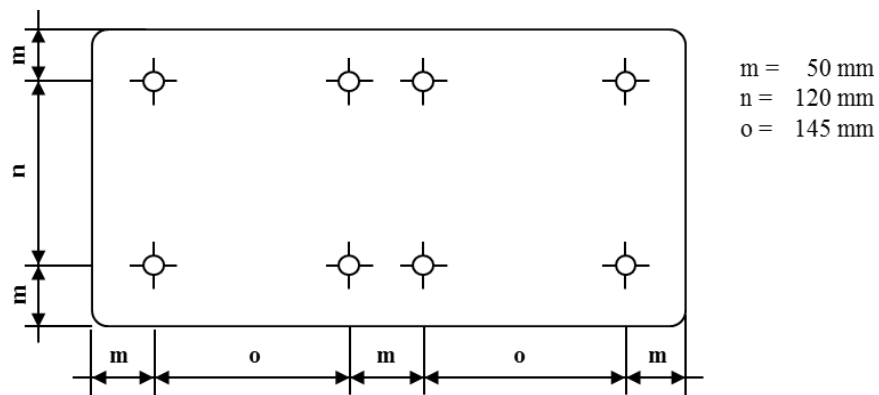

*Note:* In the case of devices for illuminating two or all of the plates, the measurement points used are obtained by combining the corresponding drawings above in accordance with the outline indicated by the make or manufacturer; however, if two measurement points are less than 30 mm apart, only one shall be used.

3.6. Category 1 (240 x 130 mm) for vehicles of class L

Figure A3-XIV: Measuring points for plate size 240 x 130 mm

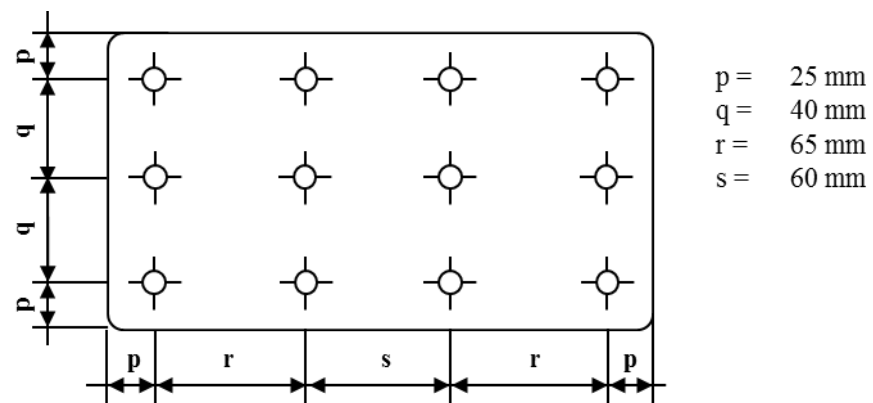

3.7. Category 2 (280 x 200 mm) for vehicles of class L

Figure A3-XV: Measuring points for plate size 280 x 200 mm

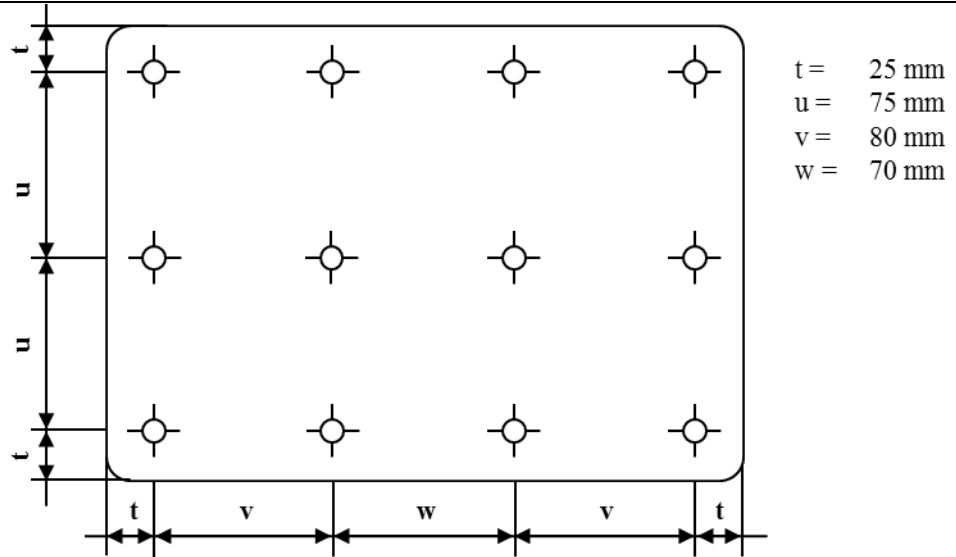

## Annex 4

### Minimum requirements for conformity of production control procedures

1. General
  - 1.1. The conformity requirements shall be considered satisfied from a mechanical and geometric standpoint, if the differences do not exceed inevitable manufacturing deviations within the requirements of this UN Regulation.
  - 1.2. With respect to photometric performances, the conformity of mass-produced lamps shall not be contested if, when testing photometric performances of any lamp chosen at random according to paragraph 4.7. of this UN Regulation.
    - 1.2.1. No measured value deviates unfavourably by more than 20 per cent from the values prescribed in this UN Regulation

For the minimum values required throughout the fields specified in Annexes 2 and 3 the respective maximum deviations of the measured values shall correspond to the values shown in table A4-1:

Table A4-1: 20 and 30 per cent values for CoP

<i>Required minimum value</i>	<i>Equivalent 20 per cent</i>	<i>Equivalent 30 per cent</i>
cd	cd	cd
0,7	0,5	0,3
0,6	0,4	0,2
0,3	0,2	0,1
0,07	0,05	0,03
0,05	0,03	0,02

- 1.2.1.1. For rear-registration plate illuminating lamps:
 

With respect to the gradient of luminance the unfavourable deviation shall be:

Table A4-2: 20 and 30 per cent values for CoP, Rear-registration plate illuminating lamps

<i>Unfavourable deviation</i>		
2.5 x Bo/cm	comparable to	20 per cent
3.0 x Bo/cm	comparable to	30 per cent

- 1.2.2. If, in the case of a lamp equipped with a replaceable light source and if results of the test described above do not meet the requirements, tests on lamps shall be repeated using another standard light source.
- 1.3. The chromaticity coordinates shall be complied with when tested under conditions of paragraph 4.7. of this UN Regulation.
- 1.4. In the case of non-replaceable filament light source(s) or light source module(s) equipped with non-replaceable filament light source, at any conformity of production check:

- 
- 1.4.1. the holder of the approval mark shall demonstrate the use in normal production and show the identification of the non-replaceable filament light source(s) as indicated in the type approval documentation;
- 1.4.2. in the case where doubt exists in respect to compliance of the non-replaceable filament light source(s) with lifetime requirements and/or, in the case of colour coated filament light sources, with colour endurance requirements, as specified in paragraph 4.11 of IEC 60809, Edition 3, conformity shall be checked as specified in paragraph 4.11 of IEC 60809, Edition 3.
2. Minimum requirements for verification of conformity by the manufacturer
- For each type of lamp, the holder of the approval mark shall carry out at least the following tests, at appropriate intervals. The tests shall be carried out in accordance with the provisions of this UN Regulation.
- If any sampling shows non-conformity with regard to the type of test concerned, further samples shall be taken and tested. The manufacturer shall take steps to ensure the conformity of the production concerned.
- 2.1. Nature of tests
- Tests of conformity in this UN Regulation shall cover the photometric and colorimetric characteristics.
- 2.2. Methods used in tests
- 2.2.1. Tests shall generally be carried out in accordance with the methods set out in this UN Regulation.
- 2.2.2. In any test of conformity carried out by the manufacturer, equivalent methods may be used with the consent of the competent authority responsible for approval tests. The manufacturer is responsible for proving that the applied methods are equivalent to those laid down in this UN Regulation.
- 2.2.3. The application of paragraphs 2.2.1. and 2.2.2. requires regular calibration of test apparatus and its correlation with measurements made by a competent authority.
- 2.2.4. In all cases the reference methods shall be those of this UN Regulation, particularly for the purpose of administrative verification and sampling.
- 2.3. Nature of sampling
- Samples of lamps shall be selected at random from the production of a uniform batch. A uniform batch means a set of lamps of the same type, defined according to the production methods of the manufacturer.
- The assessment shall in general cover series production from individual factories. However, a manufacturer may group together records concerning the same type from several factories, provided these operate under the same quality system and quality management.
- 2.4. Measured and recorded photometric and colorimetric characteristics



The sampled lamp shall be subjected to photometric measurements for the minimum values at the points listed in Annex 3. and the required chromaticity coordinates.

2.5. Criteria governing acceptability

The manufacturer is responsible for carrying out a statistical study of the test results and for defining, in agreement with the competent authority, criteria governing the acceptability of his products in order to meet the requirements laid down for verification of conformity of products in paragraph 3.5.1. of this UN Regulation.

The criteria governing the acceptability shall be such that, with a confidence level of 95 per cent, the minimum probability of passing a spot check in accordance with Annex 5 would be 0.95.

---

**Annex 5****Minimum requirements for sampling by an inspector**

1. General provisions
  - 1.1. The conformity requirements shall be considered satisfied from a mechanical and a geometric standpoint, in accordance with the requirements of this UN Regulation, if any, if the differences do not exceed inevitable manufacturing deviations.
  - 1.2. With respect to photometric performance, the conformity of mass-produced lamps shall not be contested if, when testing the photometric performances set forth in Paragraph 4.7. of this UN Regulation of any lamp chosen at random:
    - (a) No measured value deviates from the values prescribed in Paragraph 1.2.1. in Annex 4.
    - (b) If, in the case of a lamp equipped with a replaceable light source and if results of the test described above do not meet the requirements, tests on lamps shall be repeated using another standard light source.
  - 1.3. Lamps with apparent defects are disregarded.
  - 1.4. The chromaticity coordinates shall be complied when tested under conditions of paragraph 4.7. of this UN Regulation.
2. First sampling

Four lamps are selected at random. The first sample of two is marked A, the second sample of two is marked B.

  - 2.1. The conformity of mass-produced lamps shall not be contested if the deviation of any specimen of samples A and B (all four lamps) is not more than 20 per cent.

In the case, that the deviation of both lamps of sample A is not more than 0 per cent the measurement can be terminated.
  - 2.2. The conformity of mass-produced lamps shall be contested if the deviation of at least one specimen of samples A or B is more than 20 per cent.

The manufacturer shall be requested to bring its production in line with the requirements (alignment) and a repeated sampling according to paragraph 3 shall be carried out within two months' time after the notification. The samples A and B shall be retained by the Technical Service until the entire CoP process is finished.
3. First repeated sampling

A sample of four lamps is selected at random from stock manufactured after alignment. The first sample of two is marked C, the second sample of two is marked D.

  - 3.1. The conformity of mass-produced lamps shall not be contested if the deviation of any specimen of samples C and D (all four lamps) is not more than 20 per cent.

In the case, that the deviation of both lamps of sample C is not more than 0 per cent the measurement can be terminated.

- 
- 3.2. The conformity of mass-produced lamps shall be contested if the deviation of at least one specimen of samples C or D is:
- 3.2.1. More than 20 per cent but the deviation of all specimens of these samples is not more than 30 per cent.
- The manufacturer shall be requested again to bring its production in line with the requirements (alignment).
- A second repeated sampling according to paragraph 4 shall be carried out within two months' time after the notification. The samples C and D shall be retained by the Technical Service until the entire COP process is finished.
- 3.2.2. One specimen of samples C or D is more than 30 per cent. In this case the approval shall be withdrawn and paragraph 5 shall be applied.
4. Second repeated sampling
- A sample of four lamps is selected at random from stock manufactured after alignment. The first sample of two is marked E, the second sample of two is marked F.
- 4.1. The conformity of mass-produced lamps shall not be contested if the deviation of any specimen of samples E and F (all four lamps) is not more than 20 per cent. In the case, that the deviation of both lamps of sample E is not more than 0 per cent the measurement can be terminated.
- 4.2. The conformity of mass-produced lamps shall be contested if the deviation of at least one specimen of samples E or F is more than 20 per cent. In this case the approval shall be withdrawn and paragraph 5 shall be applied.
5. Approval withdrawn
- As required according to paragraphs 4.1. and 4.2., approval shall be withdrawn according to paragraph 3.6. of this UN Regulation.

---

**Annex 6****Heat resistance test for rear fog lamps and daytime running lamps**

1. The lamp shall be subjected to a one-hour test of continuous operation following a warm-up period of 20 minutes. The ambient temperature shall be  $23\text{ °C} \pm 5\text{ °C}$ . The light source used shall be a light source of the category specified for the lamp, and shall be supplied with a current at a voltage such that it gives the specified average power at the corresponding test voltage. However, for lamps equipped with non-replaceable light sources (filament light sources and other), the test shall be made with the light sources present in the lamp, in accordance with paragraph 5.4.1. of this UN Regulation.
2. Where only the maximum power is specified, the test shall be carried out by regulating the voltage to obtain a power equal to 90 per cent of the specified power. The specified average or maximum power referred to above shall in all cases be chosen from the voltage range of [6~~7~~] 12 or 24 V at which it reaches the highest value; for lamps equipped with non-replaceable light sources the test conditions set in paragraph 5.9.1. of this UN Regulation shall be applied.
  - 2.1. In the case of light sources operated by an electronic control gear to obtain variable luminous intensity, the test shall be carried out under the conditions given at minimum 90 per cent of the higher luminous intensity.
3. After the lamp has been stabilized at the ambient temperature, no distortion, deformation, cracking or colour modification shall be perceptible. In case of doubt the intensity of light shall be measured according to paragraph 5. of this UN Regulation. At that measurement the values shall reach at least 90 per cent of the values obtained before the heat resistance test on the same lamp.

## Annex 7

### Arrangement of approval marks

The following approval mark arrangements are given merely as examples and any other arrangement made in accordance with paragraph 3.3. of this UN Regulation is acceptable.

#### 1. APPROVAL MARK OF A SINGLE LIGHT SIGNALLING LAMP

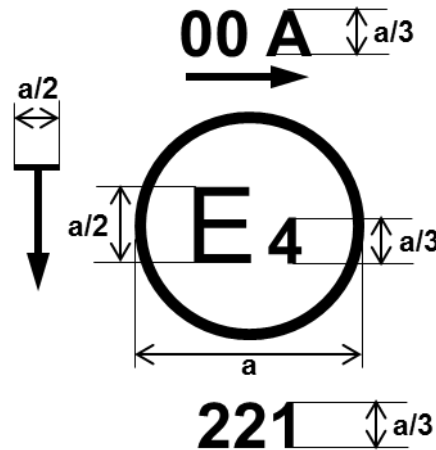

$a \geq 5 \text{ mm}$

Figure A7-I:

The lamp bearing the approval mark shown on the left is a front position lamp (A) approved in the Netherlands (E4), under approval number 221 pursuant to this UN Regulation.

The number (00) mentioned close to the symbol "A" indicates that approval was granted in accordance with the requirements of this UN Regulation as set in the original series of amendments. The horizontal arrow indicates the outwards of the vehicle. The vertical arrow starting from a horizontal segment and directed downwards indicates a lamp with reduced light distribution (vertically downwards and/or horizontally below the H plane).

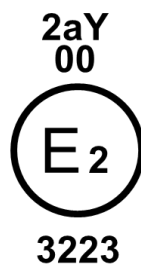

Figure A7-II:

The lamp bearing the approval mark shown on the left is a rear direction indicator (category 2A) approved in France (E2), under approval number 3223 pursuant to this UN Regulation as set in the original series of amendments (00).

The additional letter "Y" indicates this direction indicator as being a part of an interdependent lamp system.

2. APPROVAL MARK OF GROUPED, COMBINED OR RECIPROCALLY INCORPORATED LAMPS.

Note: The vertical and horizontal lines schematize the shape of the light-signalling lamp. These lines are not part of the approval mark.

Figure A7-III:

	3333 IA 00 E4	2b 00	F2 00	R2 00		3333 IA 2b R2 00 00 00 F2 AR S2 00 00 00		
	F2 00	AR 00						

IA 2b R2 00 00 00 F2 AR S2 00 00 00  3333 E4			

These examples of approval marks represent three possible solutions for the marking of a light signalling lamp where two or more lamps are part of the same assembly of grouped, combined or reciprocally incorporated lamps.

They indicate that the lamp was approved in the Netherlands (E4) under approval number 3333 and comprises:

- (a) A retro-reflector of class 1A approved in accordance with the 02 series of amendments;
- (b) A rear direction indicator lamp with variable luminous intensity (category 2b) approved in accordance with the 01 series of amendments;
- (c) A rear position lamp with variable luminous intensity (R2) approved in accordance with the 02 series of amendments;
- (d) A rear fog lamp with variable luminous intensity (F2) approved in accordance with the original version;
- (e) A reversing lamp (AR) approved in accordance with the original version;
- (f) A stop lamp with variable luminous intensity (S2) approved in accordance with the 02 series of amendments.

3. APPROVAL MARK OF A LAMP WHERE THE LENS IS INTENDED TO BE USED IN DIFFERENT TYPES OF LAMPS.

Figure A7-IV:

**F1 2a AR R1 S1**  
**00 00 00 00 00**

**E<sub>9</sub>**

**1432**

This example corresponds to the marking of a lens intended to be used in different types of light signalling lamps. The approval marks indicate that the lamp was approved in Spain (E9) under approval number 1432 and may comprise all listed different functions.

The main body of the lamp shall bear the only valid approval mark.

4. IDENTIFICATION CODE OF LIGHT SOURCE MODULES

Figure A7-V:

**MD E3 17325**

The light source module bearing the identification code shown above has been approved together with a lamp approved in Italy (E3) under approval number 17325.

## II. Justification

1. At the 156th session of WP.29, the European Union, supported by Japan, urged WP.29 to consider the simplification of the lighting Regulations and to focus upon developing less technology-specific, more performance-related requirements (ECE/TRANS/WP.29/1095, paras. 76 and 77).
2. At the 157th session of WP.29, GTB presented its approach to help GRE work on consolidating the Regulations on lighting and light-signalling to reduce the administrative workload. The suggested approach sought to reduce the number of Regulations concerning lighting and light-signalling.
3. Subsequently the GTB approach was formally considered by WP.29 at its 158th session. WP.29 endorsed the principles proposed by GTB and asked GRE to develop a road map, taking into consideration the resources of GRE.
4. At its sixty-ninth session, GRE agreed to create a special interest group of experts, which met in February and in June 2014. This group was transformed into a new GRE "Informal Group on Simplification of the Lighting and Light-Signalling Regulations" (IWG SLR)" that held its first meeting in September 2014 and established its Terms of Reference that were adopted by GRE at its seventy-second session in October 2014.
5. At its 164th session, WP.29 approved the establishment of IWG SLR with the aim to review the current suite of lighting and light-signalling Regulations and to develop a proposal with the following objectives:
  - Provide a structure that limits to a minimum the number of parallel amendments necessary to achieve a regulatory change;
  - Reduce the number of active Regulations;
  - Define the essential requirements in performance (technology neutral) terms to provide opportunities for innovation;
  - Reduce ambiguity in the provisions to provide consistent interpretation;
  - Reduce the administrative burden (caused by maintenance of Regulations) on the Contracting Parties, the UNECE secretariat (and associated United Nations services) and the affected industrial sector;
  - Reduce regulatory burden for industry.
6. Initially IWG SLR explored several approaches that included:
  - Moving all common requirements to a Resolution;
  - Merging all common requirements in a separate part of Regulation No. 48;
  - Using one of the existing frozen Regulations as a placeholder for the common parts.
7. All of these approaches were discussed and rejected either by GRE, WP.29 or the Office of Legal Affairs (OLA). Consequently, IWG SLR developed a proposal for a two stage approach where the first stage involved freezing the existing lighting, light-signalling and retro-reflective Regulations and the creation of three new Regulations covering all the existing provisions and requirements. These three new Regulations are:
  - Draft new Regulation on light-signaling devices (LSD)
  - Draft new Regulation on road illumination devices (RID)



- Draft new Regulation on retro-reflective devices and retro-reflective markings (RRD).

8. This new approach was developed during the seventh and eighth meetings of IWG SLR in December 2015 and January 2016. It was introduced to GRE in March 2016 (GRE-75-05) and to WP.29 in June 2016 (WP.29-169-04-Rev.1). At its 169th session WP.29 endorsed the proposal and extended the mandate of IWG (ECE/TRANS/WP.29/1123, para. 44).

9. The underlying principles for the development of the new Regulations were:

- No provision shall be changed;
- No provision shall be lost;
- No provision shall be combined with functions they do not belong to;
- No provision shall be added to any of the existing functions.

10. However, during the process of merging the existing provisions into the three new Regulations some minor adaptations had to be made. Not all of these adaptations can be easily explained but some examples may serve as a model of the approach that has been followed:

- Common requirements that are not expressed in the same manner in the existing Regulations are listed as subparagraphs with different requirements for different functions;
- Additional requirements, only associated with specific functions, are presented as lists of requirements starting with “In case of”;
- Exceptions to common requirements for distinct functions are indicated by the title or the first sentence of the paragraph (“For all road illumination devices (except cornering lamps) ...”);
- Figures have been optimised and improved without changing their contents to make them editable;
- table and figure numbers are introduced in accordance with the United Nations editorial manual.

11. All decisions during the development of these new Regulations were reached by consensus of the participants of IWG. In case no consensus could be reached, IWG sought guidance by GRE.

12. The presentation of the three new draft Regulations concludes stage 1 of the simplification process. They are accompanied by additional documents to support their introduction into the system of the 1958 Agreement, i.e.

- Adaption of the references in the installation Regulation No. 48. The corresponding revisions of UN Regulations Nos. 53, 74 and 86 are still under development.
- Transitional provisions to “freeze” the existing Regulations.
- Merging the general definitions of the existing Regulations dealing with lighting, light-signalling, retro-reflective devices and installation into one single place (i.e. Regulation No. 48).