

ACTIVITIES IN THE SYR DARYA RIVER BASIN

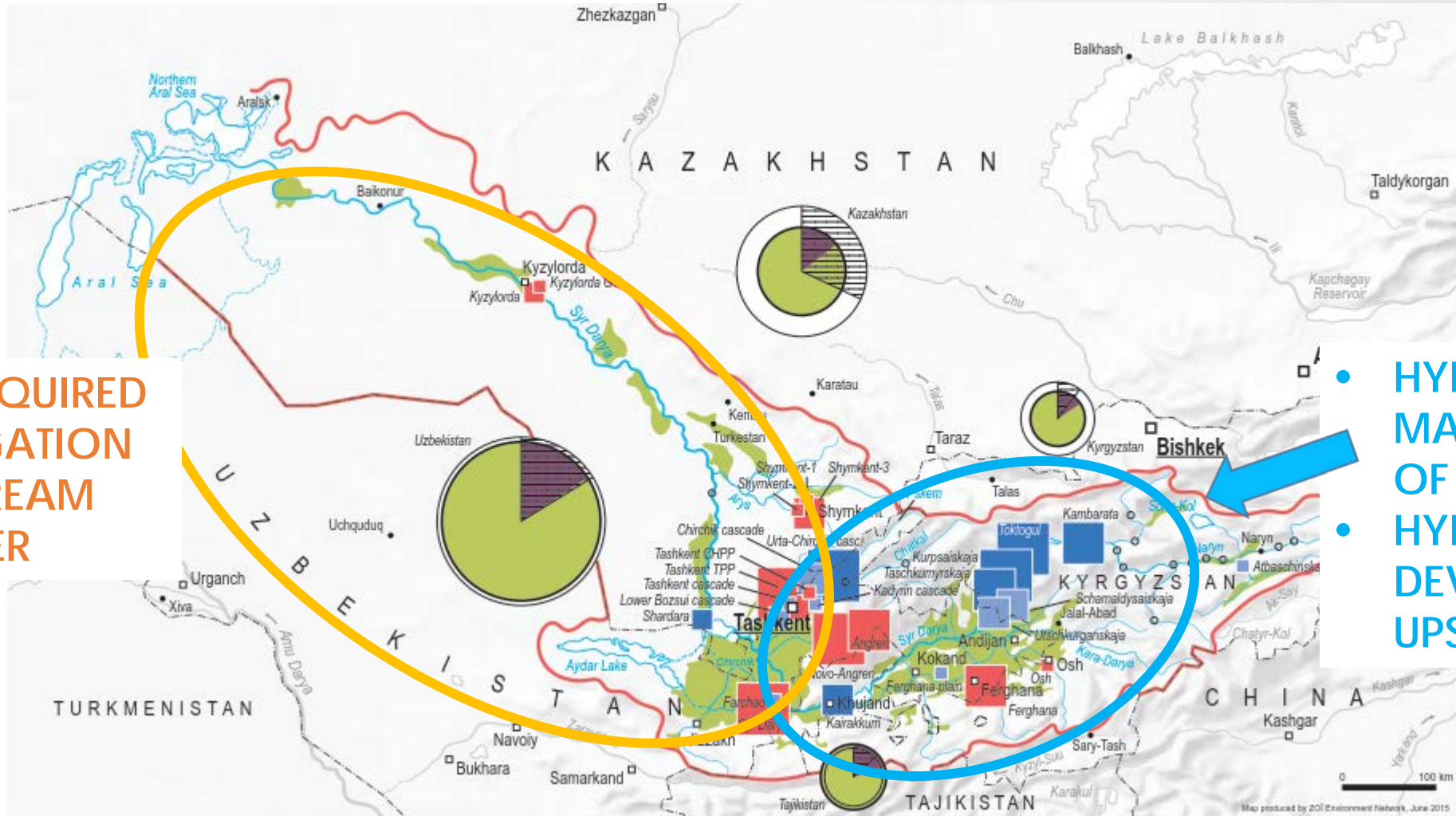

WATER REQUIRED FOR IRRIGATION DOWNSTREAM IN SUMMER

- HYDROPOWER MAIN SOURCE OF ELECTRICITY
- HYDROPOWER DEVELOPMENT UPSTREAM

NEXUS INTERLINKAGES IN THE SYR DARYA RIVER BASIN

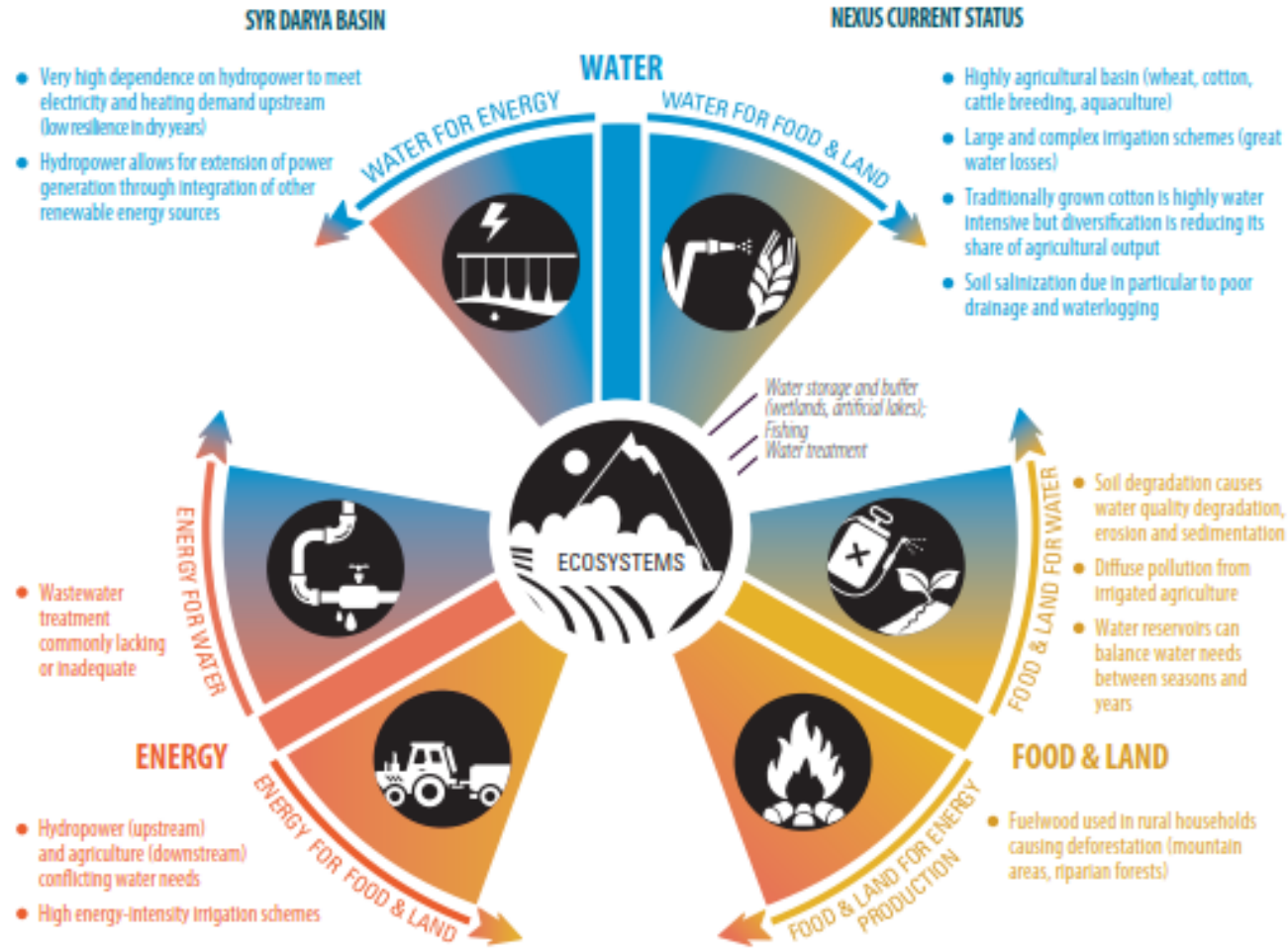

INTEGRATED WATER-ENERGY ANALYSIS - BASIS FOR IDENTIFYING OPPORTUNITIES

Development of a **multi-country power systems model** focusing on the electricity generation facilities located in the Syr Darya River Basin.

- Investigate the dependencies between the Syr Darya water resources and the power systems sector;
- Study the electricity trade dynamic-response of the multi-country energy system under different scenarios for the power systems in the region;
- Assess the impact of the diversification of the power generation mix through the expansion of non-hydro renewable energy technologies;
- Understand how aligned energy efficiency efforts can enhance regional energy security.

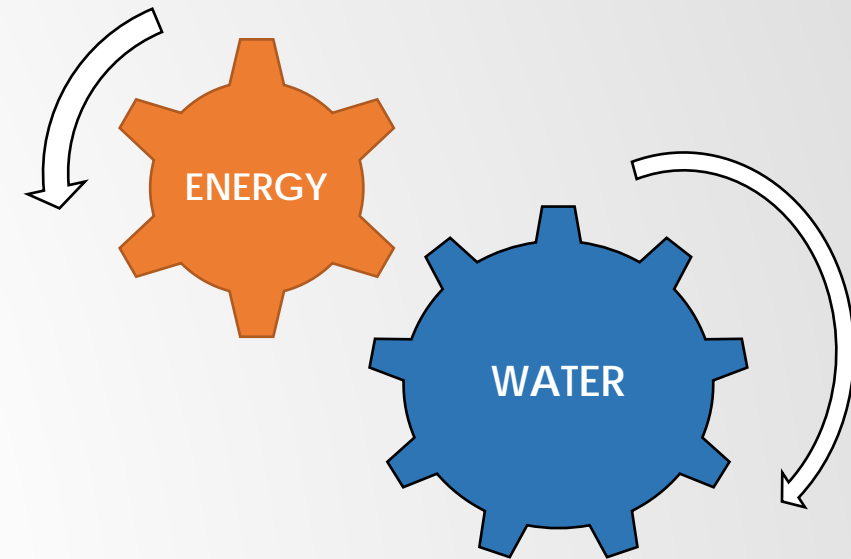

MULTI-COUNTRY POWER SECTOR ANALYSIS - BASIS FOR IDENTIFYING OPPORTUNITIES

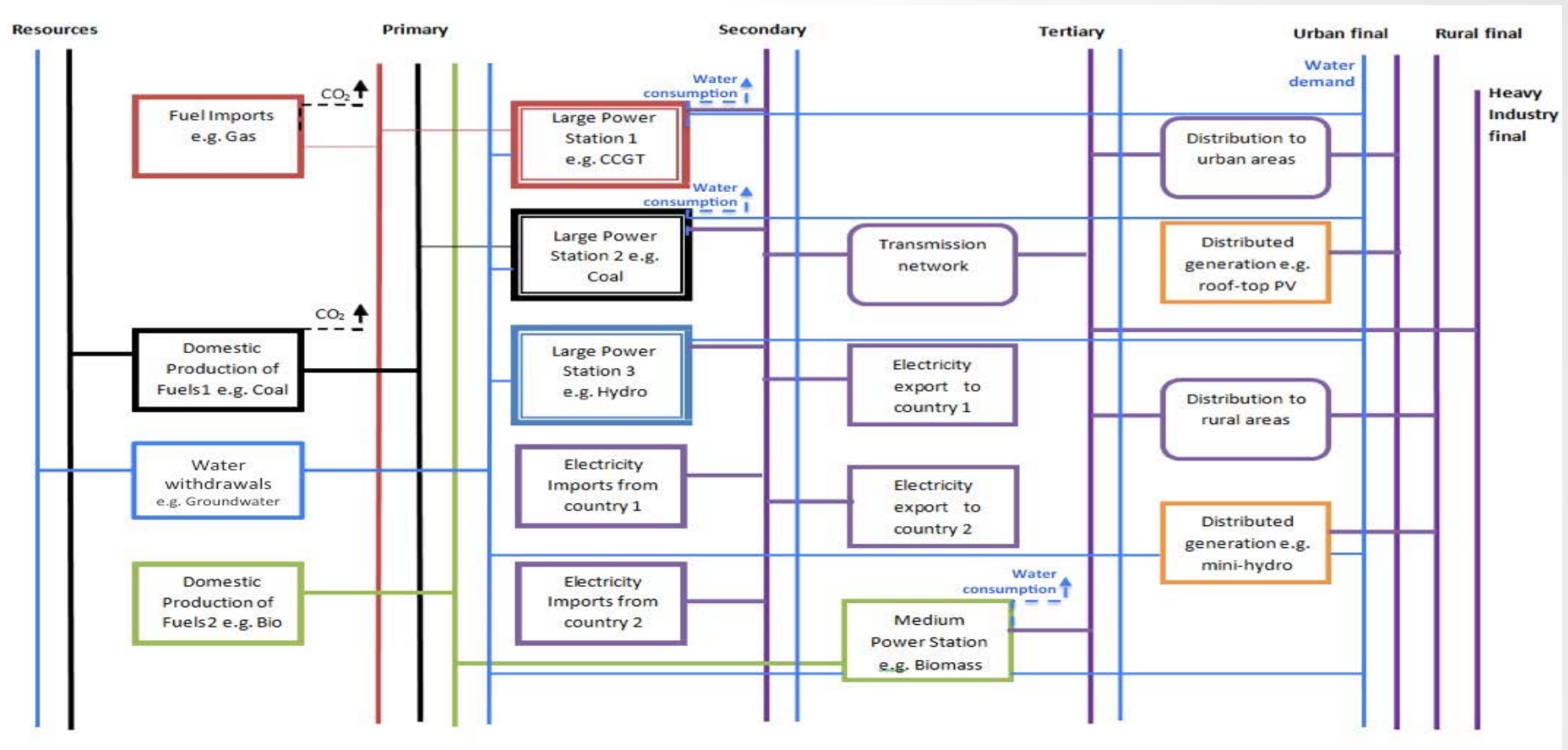

MULTI-COUNTRY POWER SECTOR ANALYSIS - BASIS FOR IDENTIFYING OPPORTUNITIES

The model for the power systems of the riparian countries took into account...

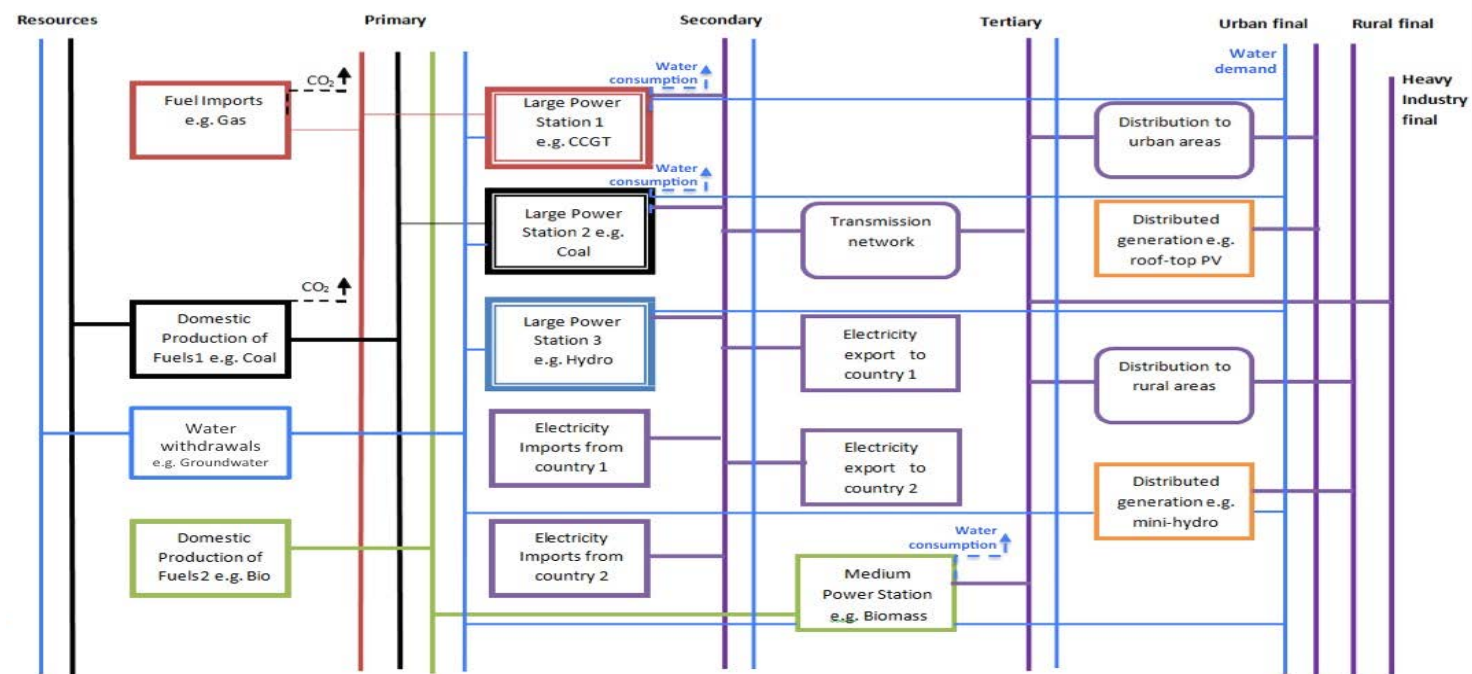

- Electricity demand of the SRB countries;
- Regional fuel costs for electricity generation, projected according to WEO (2015);
- Countries' load profile based on monthly electricity consumption for 2014;
- Existing and planned electricity generation facilities;
- Kazakhstan Green Strategy 2050;
- CO₂ emission factors;
- Electricity trade in the region based on historical data.



SCENARIOS

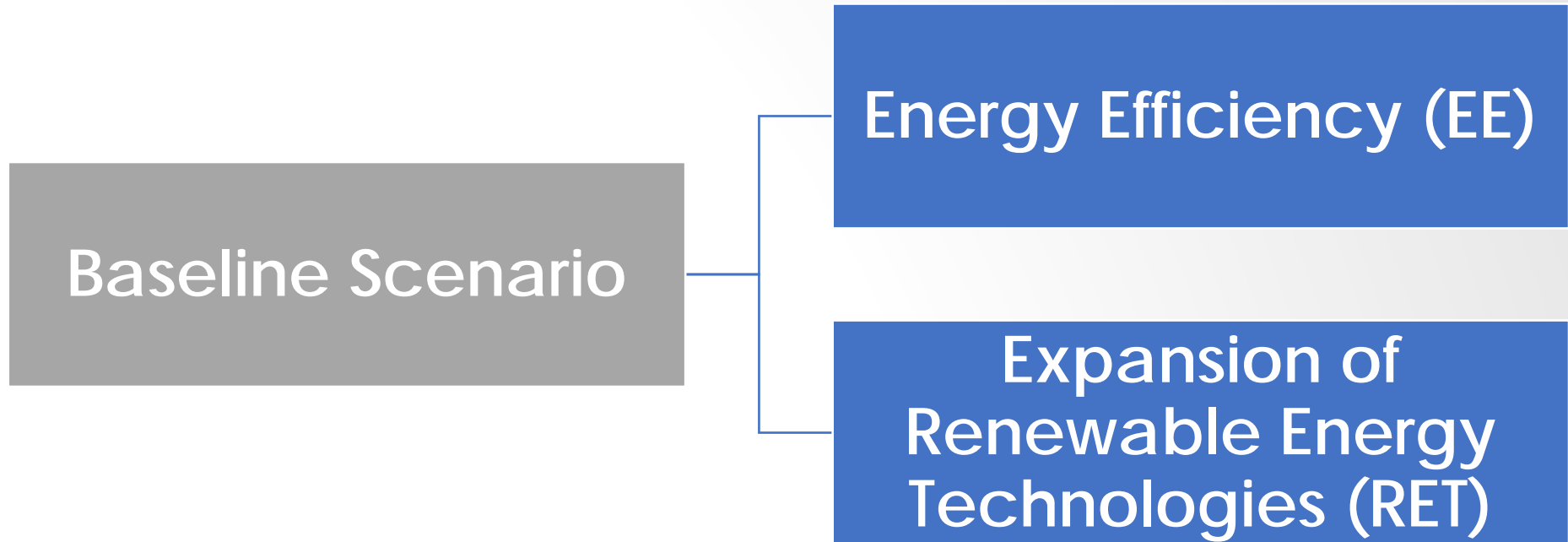

SCENARIOS – ENERGY EFFICIENCY (EE)

EE measures

- Kyrgyzstan**
- Decrease of T&D losses
 - Measures impacting the Residential sector: use of energy efficient appliances (refrigerators) and shift of 10% of electricity use to gas for space heating in winter.
- Kazakhstan**
- Decrease of T&D losses
- Tajikistan**
- Decrease of T&D losses
 - Increase of pumping efficiency in agriculture, affecting summer demand;
- Uzbekistan**
- Decrease of T&D losses
 - Increase of pumping efficiency in agriculture;
 - Shift to efficient lighting options (ILBs to CFLs)

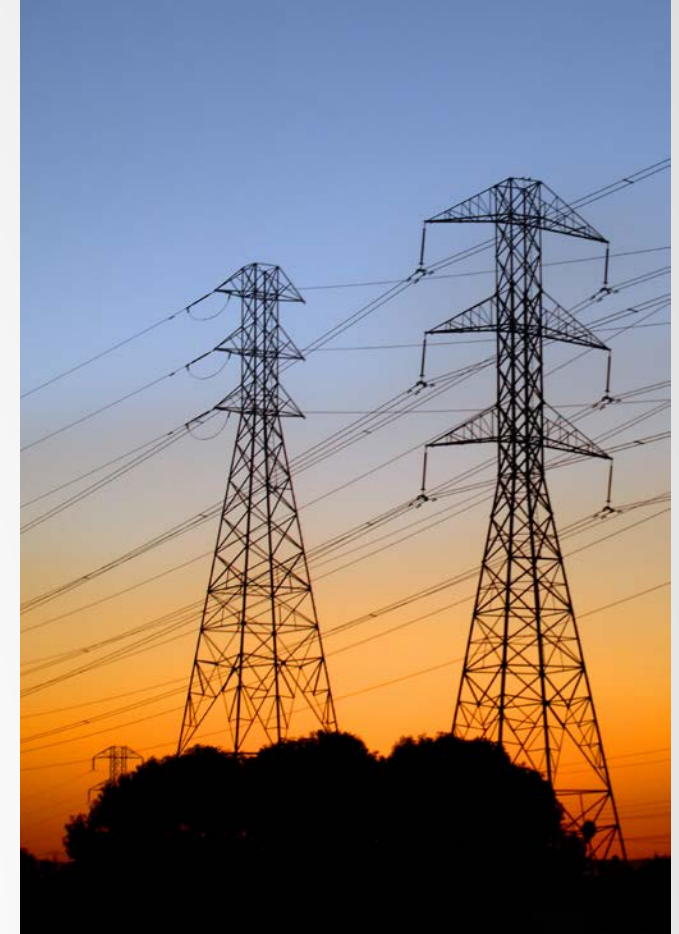

SCENARIOS – RENEWABLE ENERGY TECHNOLOGIES (RET)

RET expansion

- Kyrgyzstan** - 20% generation from wind and solar photovoltaic (PV) power plants by 2030
- Kazakhstan** - 40% generation from renewable energy sources (hydro, wind, PV) and nuclear power by 2030
- Tajikistan** - 20% generation from wind power and photovoltaic (PV) plants by 2030
- Uzbekistan** - 20% generation from wind power, photovoltaic (PV), and hydropower plants by 2030

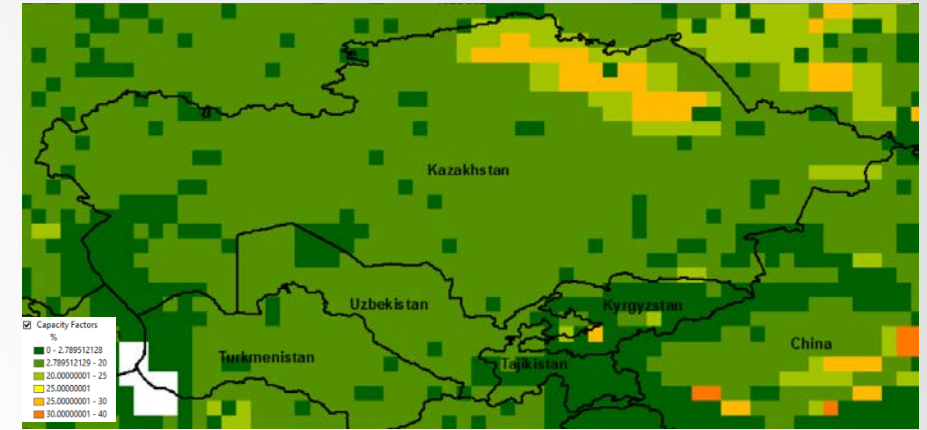
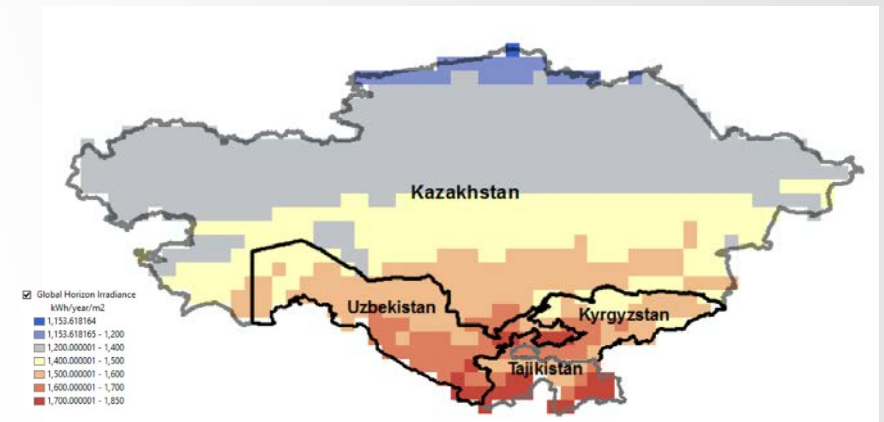

Figure 10. Estimated geospatial distribution of wind capacity factors for Kazakhstan, Uzbekistan, Tajikistan and Kyrgyzstan (Siyal et. al., 2015 and Mentis et. al., 2015)).



Global Horizon Irradiance for Kazakhstan, Kyrgyzstan, Uzbekistan and Tajikistan (developed from (NASA, 2008).

SCENARIO ANALYSIS

The scenario analysis will focus on the role of hydropower generation in the Syr Darya River basin to investigate:

- how EE and RET can impact the development of hydropower infrastructure in the basin and in the region;
- the impact on the dynamics of electricity trade in the region.



HYDROPOWER GENERATION IN THE SYR DARYA RIVER BASIN: SCENARIO COMPARISON

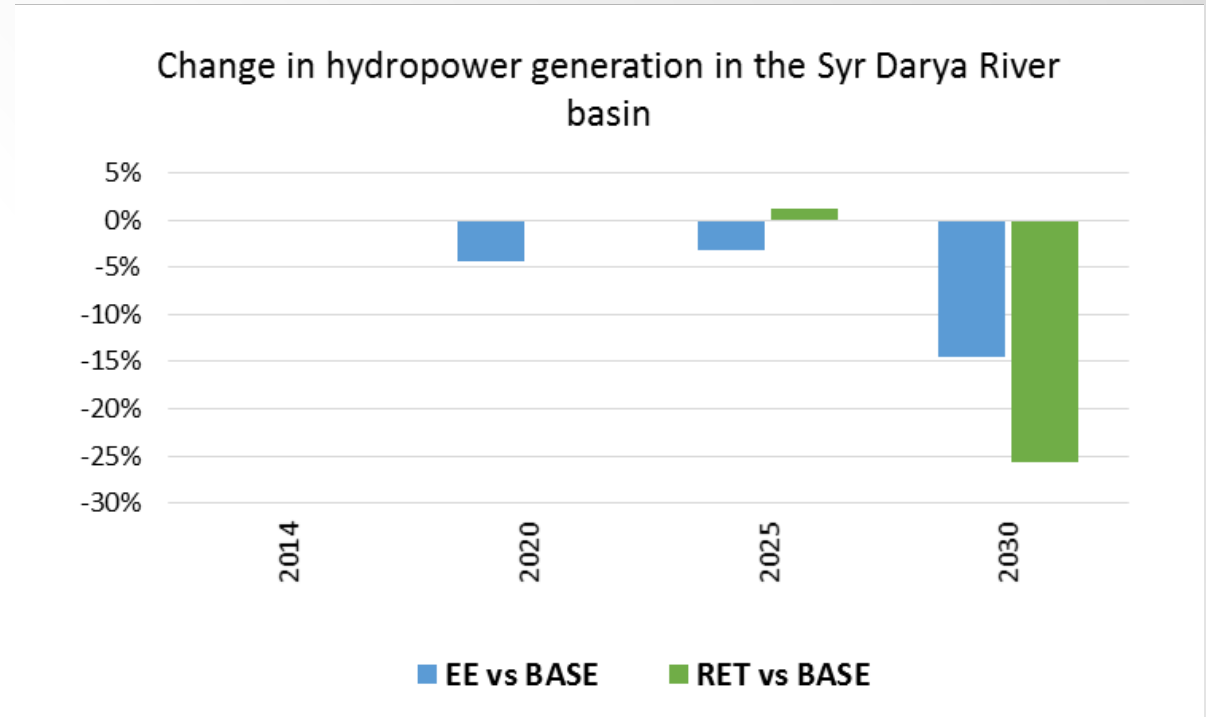
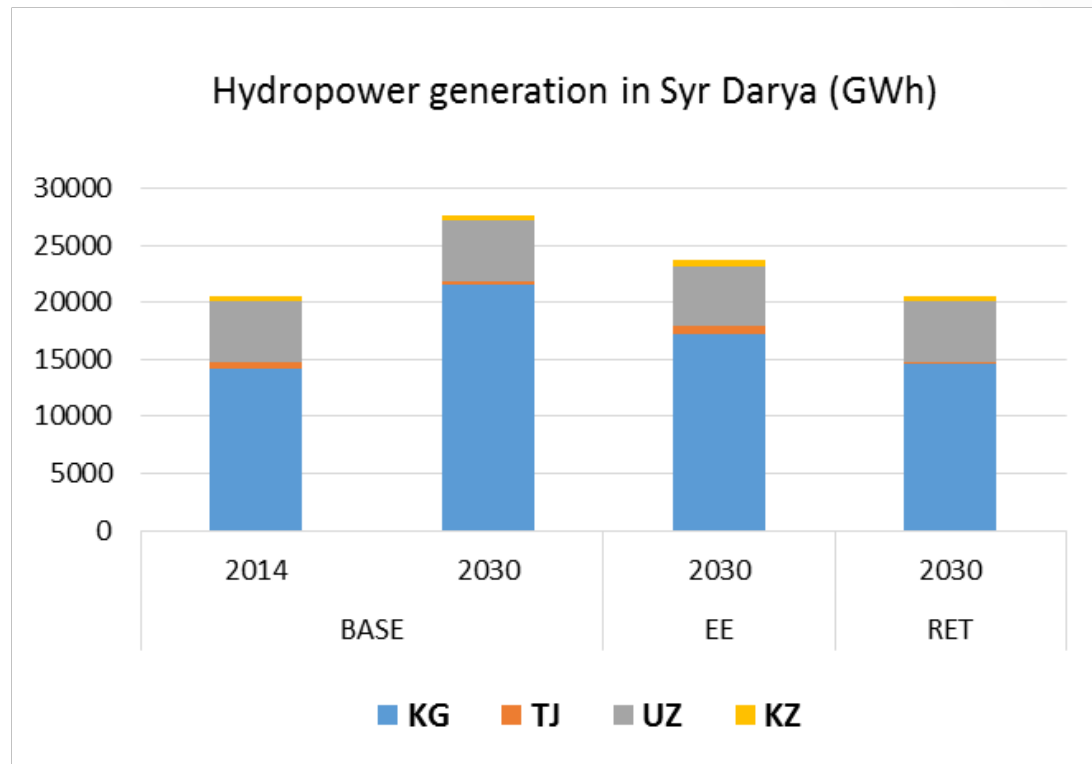

- Both EE and RET scenarios suggest a decrease in dependence from hydropower production in the Syr Darya basin;

HYDROPOWER GENERATION IN THE SYR DARYA RIVER BASIN: SCENARIO COMPARISON

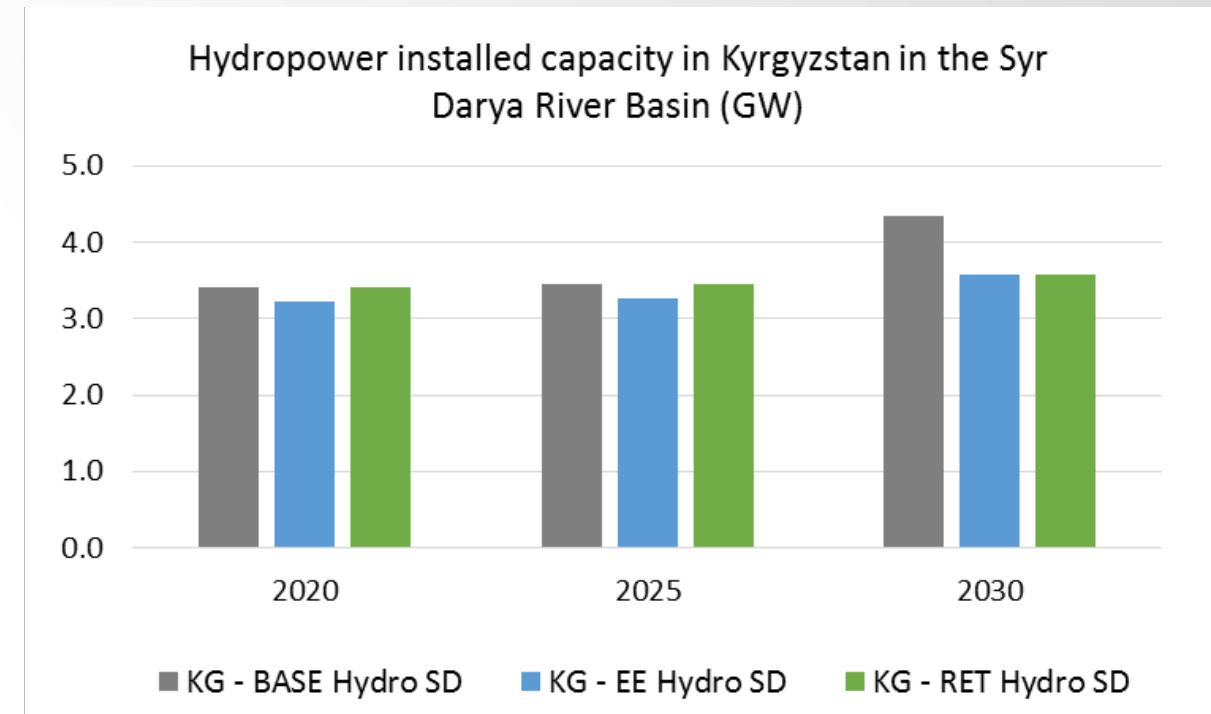
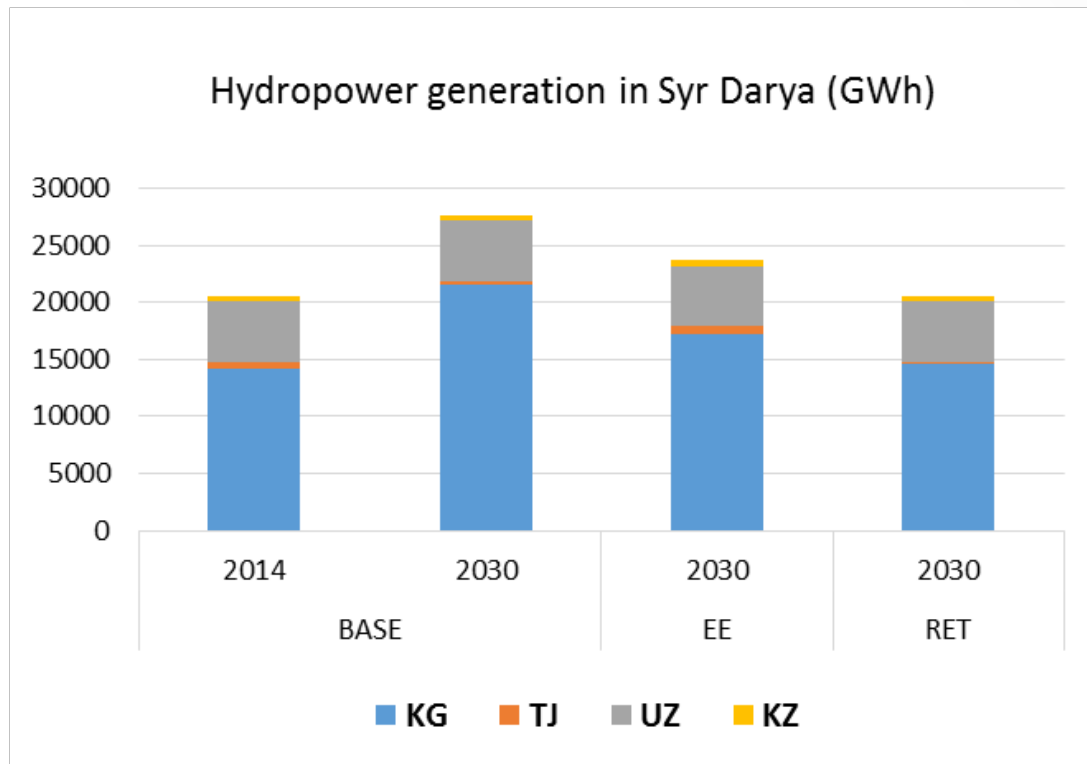

- Both EE and RET scenarios suggest a decrease in dependence from hydropower production in the Syr Darya basin;
- For Kyrgyzstan, the EE measures lessen the requirements for earlier investments in hydropower infrastructure in the basin; while the deployment of non-hydro RET to 20% of generation by 2030, proves to have a similar effect than the implementation of EE measures.

HYDROPOWER GENERATION IN THE SYR DARYA RIVER BASIN: **EXPLORING TRADE DYNAMICS**

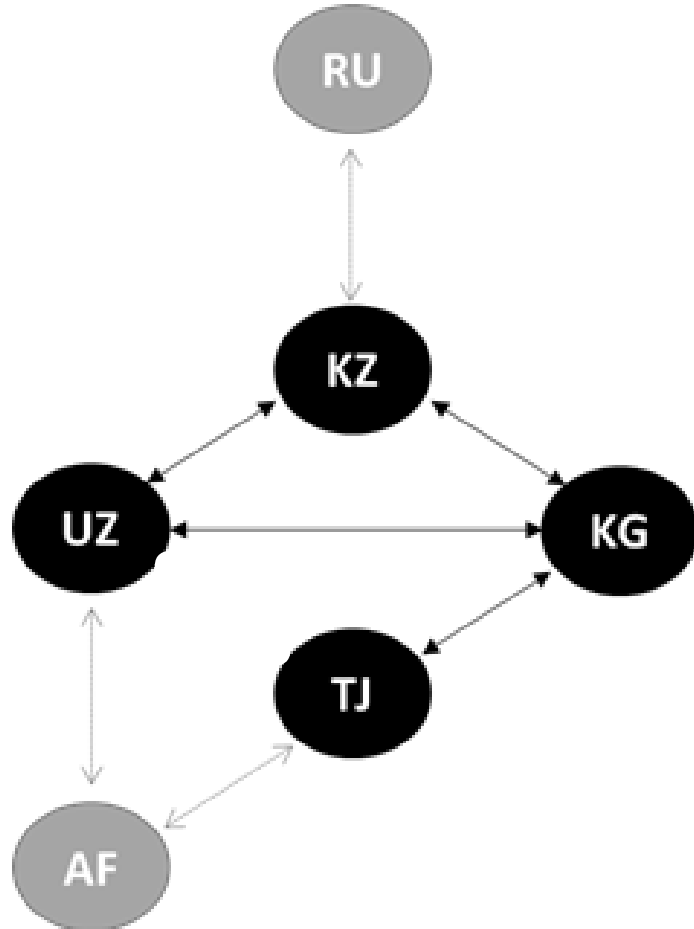

REPRESENTATION OF ELECTRICITY TRADE

- Electricity trade was represented based on historical data and on the inventory of existing interconnectors between the countries (FICHTNER, 2012; WB, 2011; MERCADOS, 2010; KEGOC Annual Reports 2009-2015).
- In the EE and RET scenarios, trade was allowed between all countries for the period 2021-2030.
- Trade with non-riparian countries, not modelled in this exercise (Russia and Afghanistan), was constrained through the definition of lower and upper limits.

HYDROPOWER GENERATION IN THE SYR DARYA RIVER BASIN: EXPLORING TRADE DYNAMICS

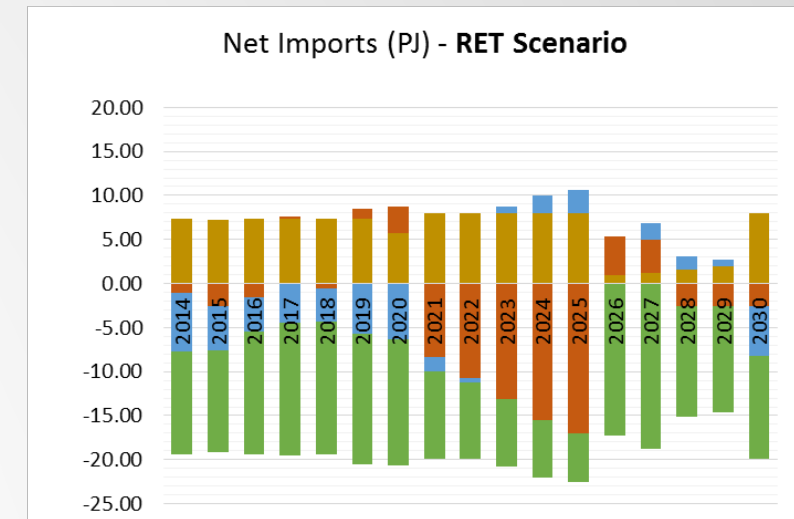
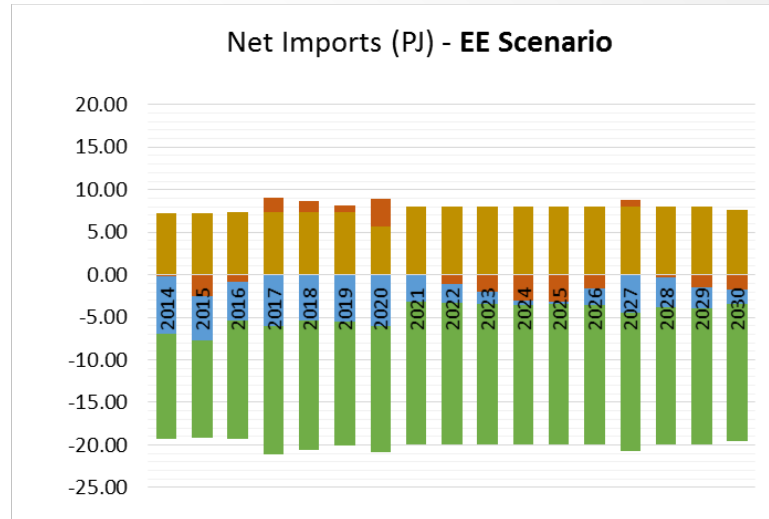
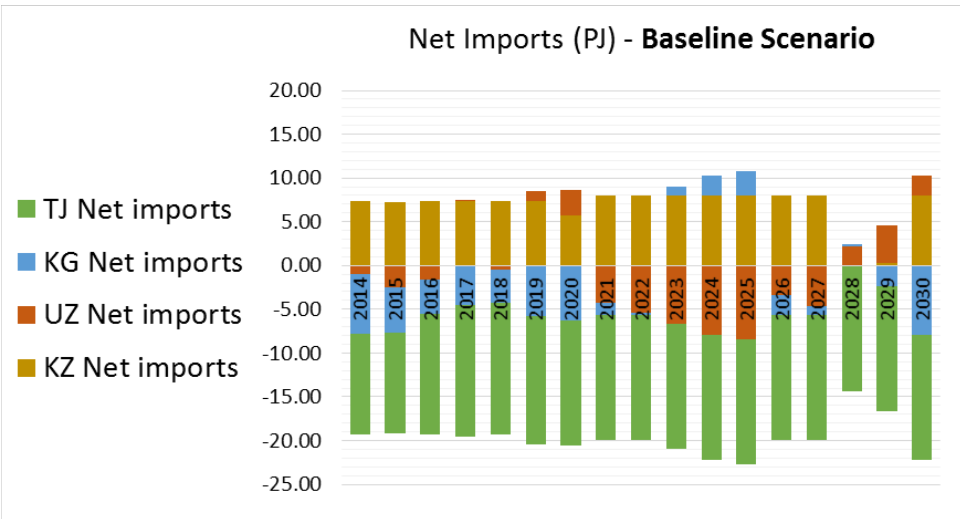

- Tajikistan role as net exporter and Kazakhstan net importer;
- Kyrgyzstan and Uzbekistan changing role in trade;

- Tajikistan role as net exporter and Kazakhstan net importer;
- Kyrgyzstan as net exporter throughout all period in comparison to the baseline;
- Uzbekistan decrease in exports due to lower demands of neighbouring countries.

- Tajikistan role as net exporter and Kazakhstan net importer;
- Increased %RET in Kazakhstan reduce the import requirements from 2026;
- Similarly to the baseline, electricity flowing to Kyrgyzstan results in a lower cost option to fossil fuel or hydropower development.
- Low gas prices in Uzbekistan enhance electricity exports.

HYDROPOWER GENERATION IN THE SYR DARYA RIVER BASIN: EXPLORING TRADE DYNAMICS

The comparison between **hydropower generation and net imports in Kyrgyzstan** suggests:

- Higher hydropower generation in the Syr Darya basin is linked to increased export capacity (Baseline and EE)

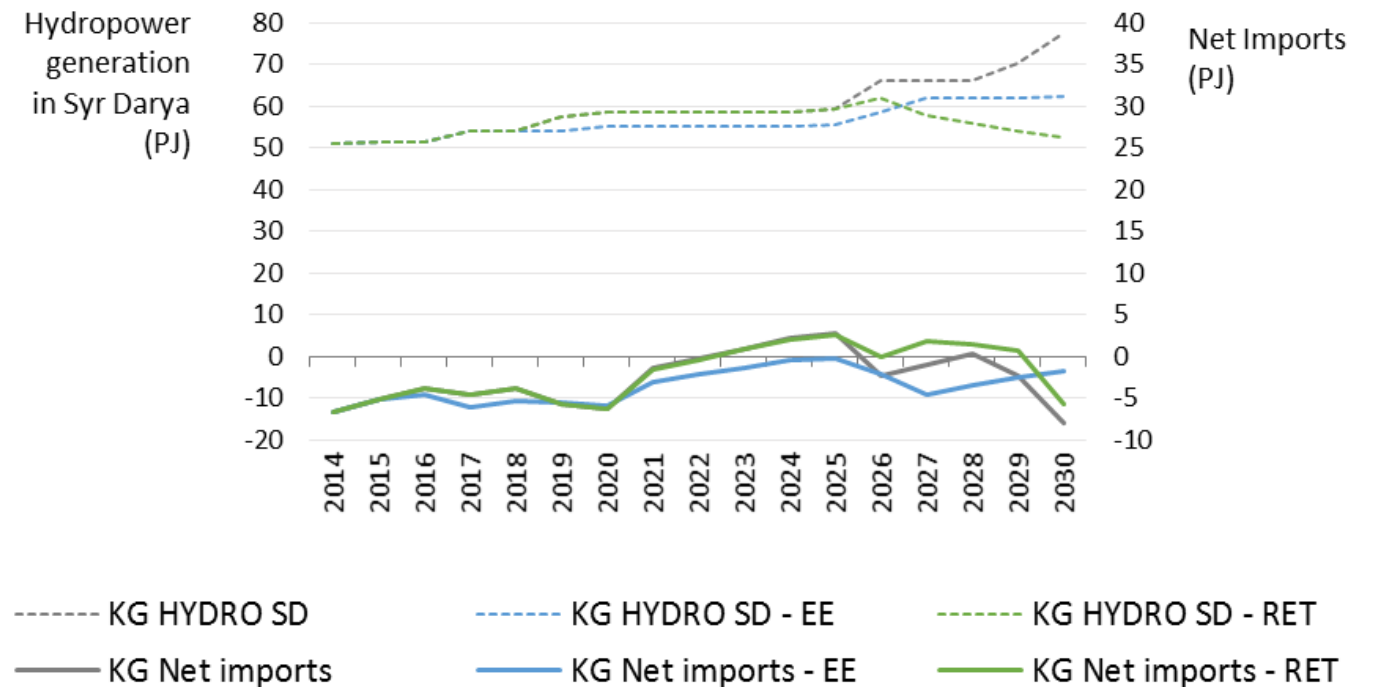

HYDROPOWER GENERATION IN THE SYR DARYA RIVER BASIN: EXPLORING TRADE DYNAMICS

BASELINE SCENARIO

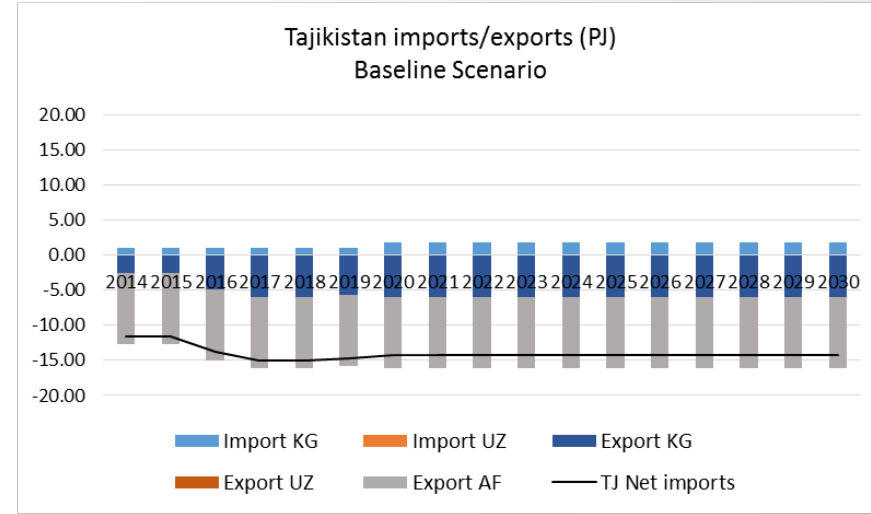
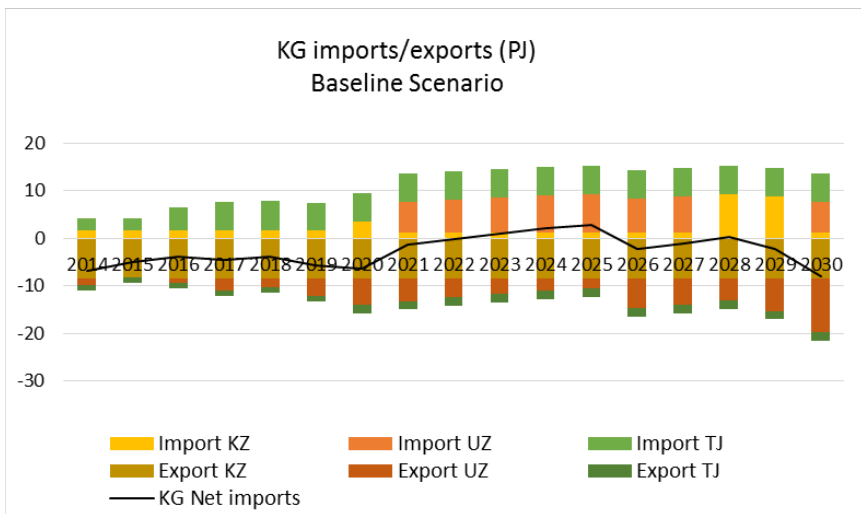
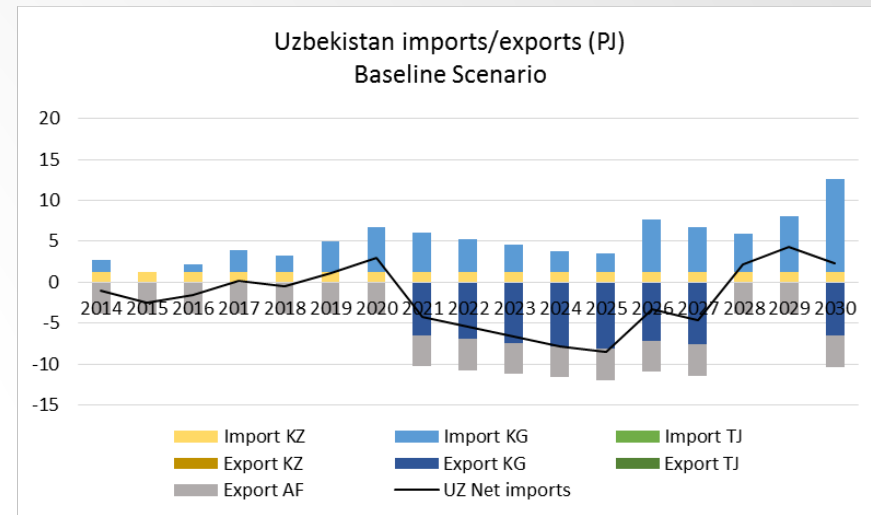
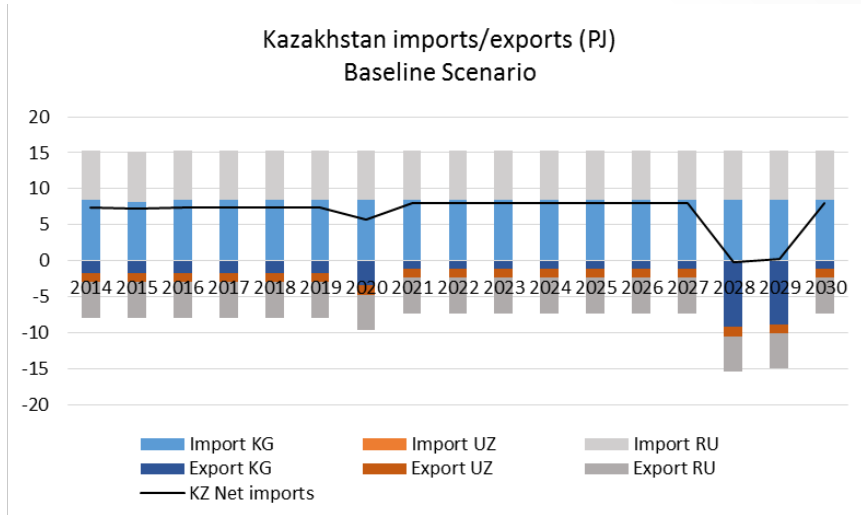

HYDROPOWER GENERATION IN THE SYR DARYA RIVER BASIN: EXPLORING TRADE DYNAMICS

EE
SCENARIO

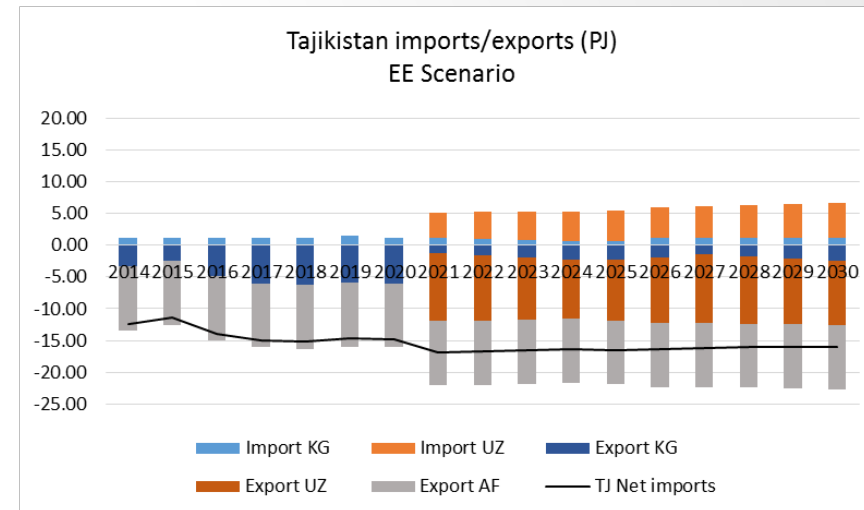
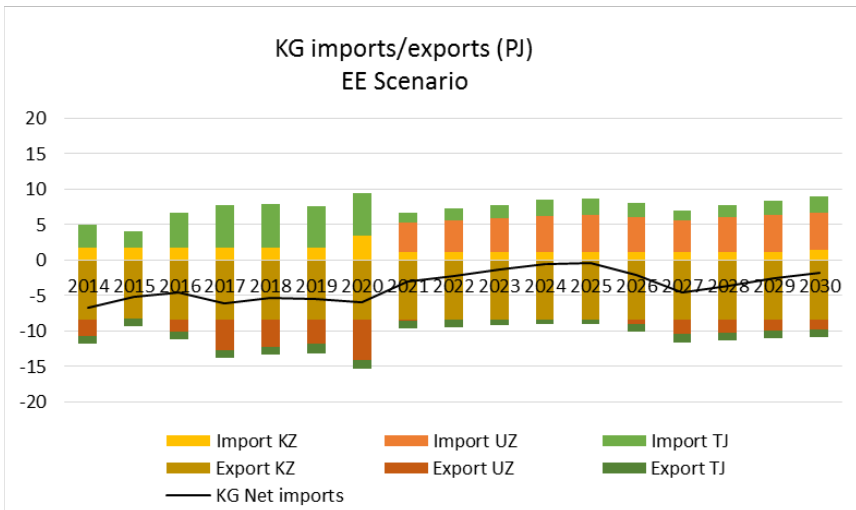
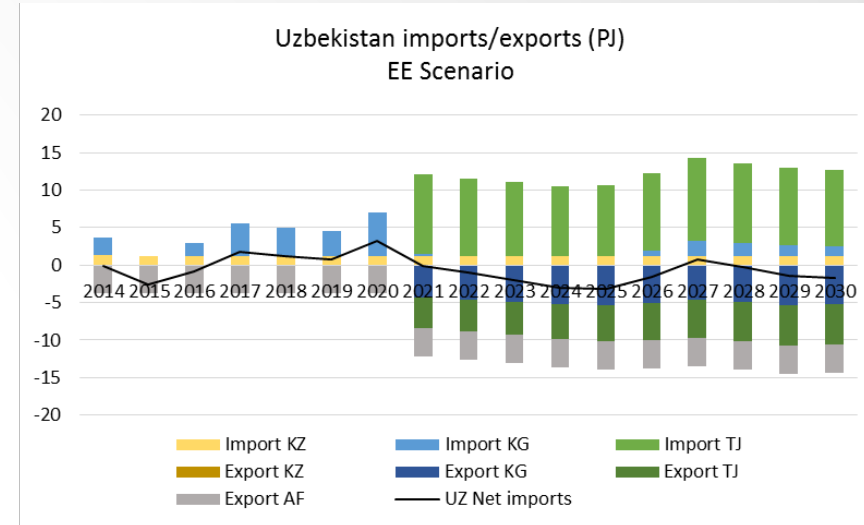
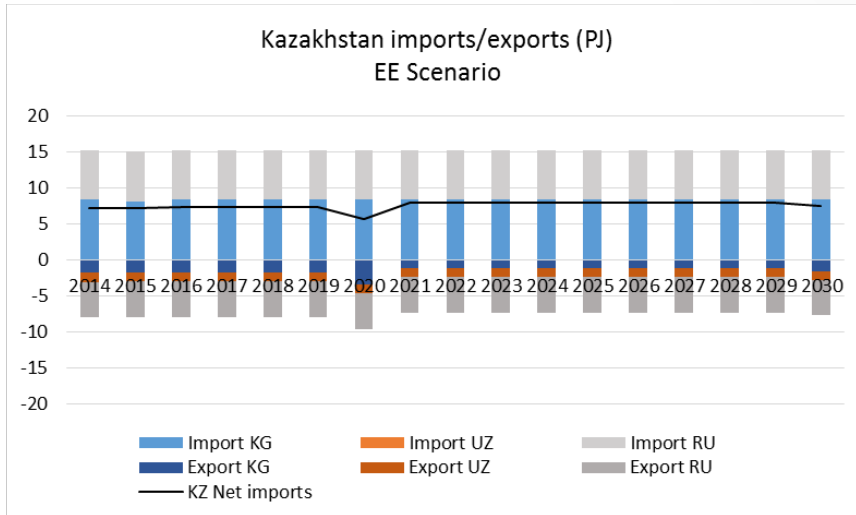

HYDROPOWER GENERATION IN THE SYR DARYA RIVER BASIN: EXPLORING TRADE DYNAMICS

RET
SCENARIO

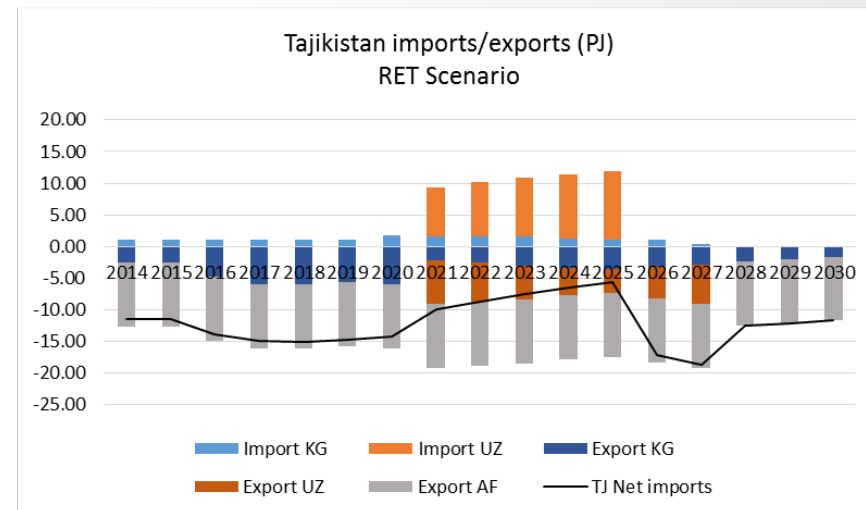
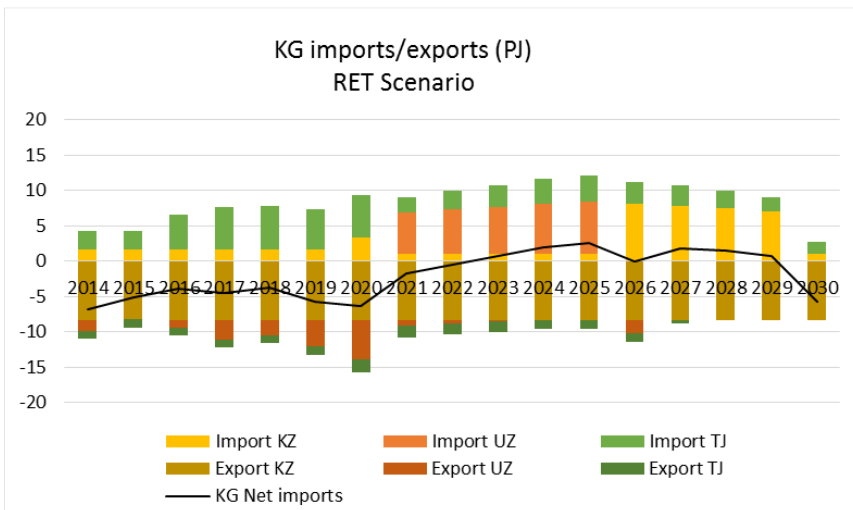
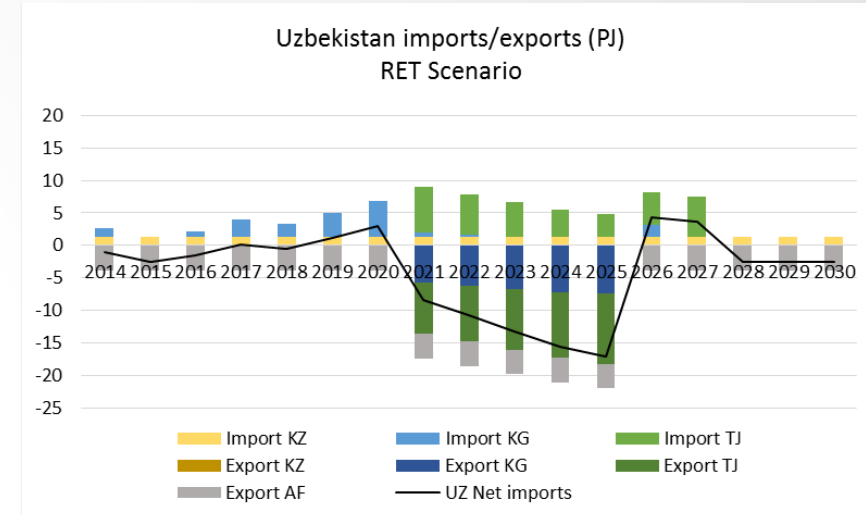
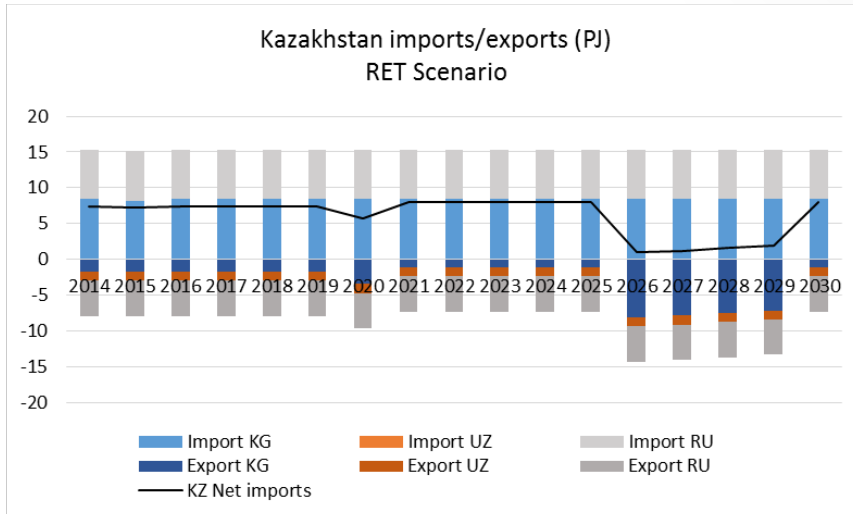

HYDROPOWER GENERATION IN THE SYR DARYA RIVER BASIN: **EXPLORING TRADE DYNAMICS**

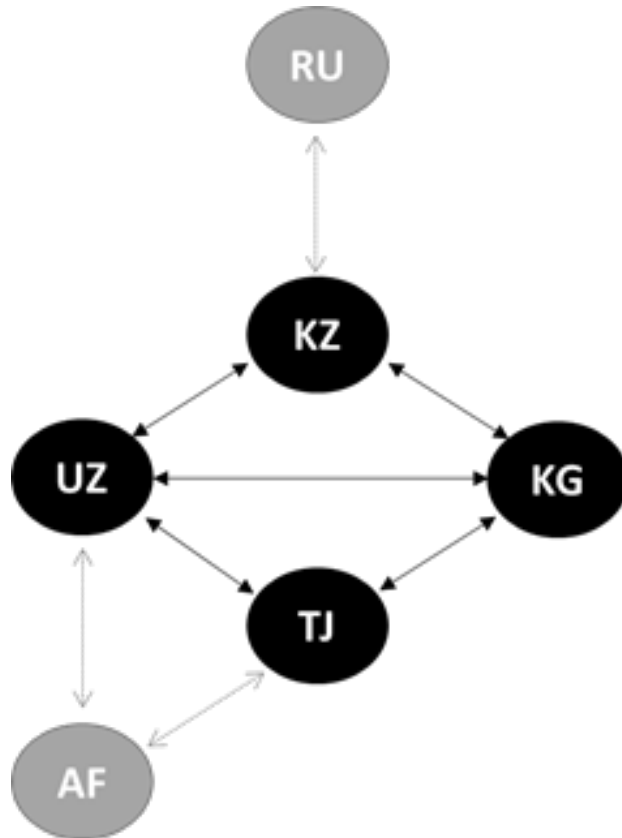

- Electricity trade between countries allows for the seasonal balancing of electricity demand;
- Electricity generation in Uzbekistan and Kazakhstan, is mostly exported to Tajikistan and Kyrgyzstan in winter months;
- Electricity exports from Tajikistan and Kyrgyzstan to other nations is higher during summer;
- Lower fuel prices in downstream nations allow for winter exports to upstream nations. Complementary, these imports are mostly compensated as exports to downstream countries in summer.



SELECTED TECHNICAL FINDINGS

- Hydropower expansion in the Syr Darya basin will be required under a BAU scenario. If EE measures are implemented the dependency from water resources for electricity generation can decrease; while the diversification of the generation mix in the region, through integration of RET (windpower and PV) also indicates to be an alternative to reduce the dependence on hydropower generation.
- Reestablishment of interregional electricity trade could reduce investments in expansion of hydropower generation in the Syr Darya basin.
- Low fuels prices for electricity generation in the downstream nations could assist in the compensation of deficits in seasonal electricity demands in upstream nations, via electricity trade.
- The implementation of EE measures in a coordinated manner in the region could decrease the electricity import requirements from upstream nations. Further efforts would likely increase the capacity for exports.



Thank you



Division of
dESA
Energy Systems Analysis

www.desa.kth.se