

---

**Economic Commission for Europe**

English

**Inland Transport Committee**

21 January 2015

**Working Party on the Transport of Dangerous Goods****Joint Meeting of Experts on the Regulations annexed to the European Agreement concerning the International Carriage of Dangerous Goods by Inland Waterways (ADN) (ADN Safety Committee)****Twenty-sixth session****Geneva, 27-30 January 2015****Item 4 (b) of the provisional agenda****Implementation of the ADN:****Special authorizations, derogations and equivalents**

---

## **Report of the meeting of the technical expert group “Bunker vessel Argos-GL”**

**Transmitted by the Government of the Netherlands**

### **I. Introduction**

1. During its meeting in August 2014 the ADN Committee discussed the request for a derogation for the tank vessel “Argos GL” for the use of membrane tanks for the carriage of liquefied natural gas (LNG). The ADN Committee decided to ask a technical expert group to further examine this proposal and the questions raised by the proposal in INF.11.

2. The group held its meeting during the 17<sup>th</sup> and 18<sup>th</sup> of November in The Hague. This meeting was attended by delegates from Germany, Netherlands, Lloyds Register, Argos and Gaztransport & Technigaz SA (GTT). GTT is a major engineering company in the field of cryogenics, storage of liquefied gases, and the development of LNG membrane containment systems for seagoing and inland vessels.

### **II. Results**

3. By means of presentation both Argos and GTT provided extensive insight on both the concept of the bunker vessel “Argos-GL” and the concept of the membrane tank onboard.

4. Major issues discussed and to be addressed further were identified, and involved e.g.:

- Transition of the requirement for seagoing vessels, that the cargo tanks never shall be partially filled,
- to avoid damages of the membrane by sloshing
- stability and integrity of the tanks in comparison to steel tanks.

- safety in case of collisions – different scenario compared with sea navigation, effects of the release of 935 m<sup>3</sup> LNG in the narrow river valleys or in the channels between settlement and industrial areas.
- ADN 9.3.4.2, Alternative constructions, use of large cargo tanks;
- In case of accidents or incidents the scenario of interaction between the cargo tanks for gasoil and the cargo tanks for LNG: for example fire and explosion in the gasoil tanks or rupture of LNG tanks and release of LNG to the shells of the gasoil cargo tanks below the deck.
- Construction of the vessel;
- Operational issues: immediate availability of boat masters with ADN Certificate for Type G tankers in bunkering enterprise; constant partially filling of the LNG tank to keep the low temperature.
- Taking fuel for the vessel's engine from the LNG cargo tanks: Allowance of connections between the LNG cargo tank and the LNG fuel tank for the vessel's engine: 7.2.4.9, 7.2.4.22 (= opening of openings of cargo tanks), 7.2.5.25.1 ADN.
- The use of electric motors inside the cargo tanks. The concept of the proposed vessel has been changed, and the use of electric motors inside the cargo tank has been abandoned.

### **III. Further process**

5. Lloyds Register has prepared a project description (Annex II) on the technical details of the Argos bunker vessel. This document includes answers to the issues identified in the technical expert meeting to be addressed further and additional questions received from several delegations.
6. For the ADN Safety Committee to get inside knowledge of the type of tank, GTT will provide an extended presentation during the 26th session.
7. The revised derogation is attached (Annex I). The technical expert group proposes that the ADN Safety Committee proceeds with discussions based on these documents.

## **Annex I**

### **Request for a recommendation**

#### **Decision of the ADN Administrative Committee relating to the tank vessel “Argos-GL”**

##### **Derogation No. xx/2015 of 2015**

The competent authority of the Netherlands is authorized to issue a trial certificate of approval for the motor tank vessel Argos-GL, yard number to be determined, type G tanker, as referred to in the ADN, for the use of membrane tanks for the carriage of liquefied natural gas (LNG).

Pursuant to paragraph 1.5.3.2 of the Regulations annexed to ADN, the above-mentioned vessel may deviate until 31 December 2018 from the following requirements:

1. Table C, UN 1972 (LNG), Column 7, cargo tank design: 1 (pressure tank). Although the membrane tanks are pressurized tanks (70 kPa), they do not comply with the definition of a pressure tank according to ADN (400 kPa).

2. Table C, UN 1972 (LNG), Column 8, cargo tank type: 1 (independent tank). Although the tank is independent from the ship's structure for temperature, it is not independent from a structural point of view.

3. 9.3.1.0.1 Tank materials. The membrane tanks are made of plywood, polyurethane foam, aluminium foil and stainless steel.

4. 9.3.1.0.2 Use of wood, aluminium and plastics in the cargo zone. The membrane tanks are made of plywood, polyurethane foam, aluminium foil and stainless steel.

5. 9.3.1.23.1 Cargo tanks need to comply with the requirements of a classification society for pressure vessels. As the tanks are not considered as a pressure vessel, these requirements are not applicable. But the membrane tanks are type approved by the classification society which classes the ship (Lloyd's Register) and other recognized classification societies.

The Administrative Committee has decided that the use of membrane tanks is sufficiently safe if the following conditions are met at all times:

1. All data related to the use of the membrane tanks shall be collected by the carrier. The data shall be sent to the competent authority on request;
2. An evaluation report shall be sent each year to the UNECE secretariat for information of the Administrative Committee. The evaluation report shall contain at least information on the following:
  - (a) operational data (e.g. temperature and pressure inside the tank);
  - (b) abnormalities, repairs and modifications to the tank;
  - (c) inspection report by the classification society which classed the vessel.



**Argos Bunkering b.v.**

**Gasoil/LNG bunker ship project**





## Table of Contents

<b>1. Design principles</b> .....	3
<b>1.1 Benefits of LNG as a fuel</b> .....	3
<b>1.2 Gasoil/LNG bunker ship project</b> .....	3
<b>1.3 Design</b> .....	3
<b>2. Operational functions</b> .....	4
<b>2.1 Gasoil cargo</b> .....	4
<b>2.2 LNG cargo</b> .....	4
<b>2.3 Membrane tanks</b> .....	5
<b>2.4 Stability</b> .....	5
<b>2.5 Compliance with the ADN</b> .....	6
<b>3. Questions following the meeting of the Expert Group</b> .....	7

Appendices:

- General arrangement of the ship
- Mark III presentation on membrane tanks
- Membrane tank calculations (AP542b, B011-0010, B011-0020)

Argos Bunkering b.v.  
Waalhaven Z.z. 11  
3089 JH Rotterdam



## 1. Design principles

### 1.1 Benefits of LNG as a fuel

With regard to other fuels LNG provides the following advantages:

- $\pm$  20% less CO<sub>2</sub> (carbon dioxide) than gasoil
- $\pm$  95% less NO<sub>x</sub> (nitrogen oxide) than gasoil
- No emission of SO<sub>x</sub>
- Price is competitively when compared to gasoil

### 1.2 Gasoil/LNG bunker ship project

The ship is designed for bunkering both seagoing vessels and inland waterway vessels, but can also be used for delivering LNG to bunkering stations. The working area of this ship is mainly in ARA (Amsterdam, Rotterdam, Antwerp) ports. This means that the movability of this ship should be perfect to handle.

### 1.3 Design

The main dimensions of the ship are:

Length 110 meters

With 13,5 meters

The following volumes are on this ship available for bunker operations:

Gasoil 4 tanks of 380 m<sup>3</sup> total 1520 m<sup>3</sup> (volume 100%)

LNG cargo 2 tanks of 935 m<sup>3</sup> total 1870 m<sup>3</sup> (volume 100%)

Three LNG-electric generators are installed for the ships' propulsion and power generation. For LNG propulsion a LNG tank of 40 m<sup>3</sup> (volume 100%) is installed. In a separate engine room in the aft ship a diesel generator is installed for back-up power.

The maximum movability of this ship will be handled by, 2 L drives (650 kW each) in the after ship and 1 channel bow thruster (500 kW). Detail description and drawings of the LNG propulsion system are included in the HAZID report of Lloyd's Register, report number 50102448-R01, date 29-4-2014.



The ship is divided into the following compartments:

Forepeak - generator room - cofferdam – gas storage tank room – cofferdam – gasoil cargo tank 1 (PS & SB) – cofferdam - LNG cargo tank 1 – cofferdam – LNG cofferdam 2 – cofferdam – gasoil cargo tank 2 (PS & SB) – cofferdam – tanks – aft engine room and PS and SB thruster rooms – aft peak.

The ship is designed with an additional (“Schelde huid”) double side construction to protect the ship for external impact.

With the use of this much cofferdams not only the cargo zone is separated from the fore- and aft ship, but also the LNG cargo tanks are separated from the gasoil tanks. All cofferdams can be flooded with water.

In Appendix 1 the general arrangement of the ship is shown.

The vessel is designed as an inland waterway Type G tanker, according the ADN 2015, the Rhine Vessels Inspection Regulations (RVIR), and the Lloyd’s Register Rules and Regulations for Inland Waterway Ships.

The class notation will be +A1 IWW Type G tanker [+]LMC.

For the LNG propulsion the ship complies with the Lloyd’s Register Rules and Regulations for Natural Gas Fuelled Ships (2014), and the draft Chapter 8b of the RVIR. A recommendation for the use of LNG as fuel has been granted by the Central Commission for Navigation on the Rhine in September 2014 (Recommendation 19/2014 dated 9-9-2014).

A recommendation from the ADN Safety Committee is also needed for the use of LNG as fuel.

## **2. Operational functions**

### **2.1 Gasoil cargo**

Argos Bunkering has a lot of expertise and experience in the world of bunkering regarding operational and environmental regulations on the inland waterways, including management skills at our office in Rotterdam to operate the bunker fleet in a safe way. This expertise will be used in this project. Similar systems, nautical technical equipment, cargo pumps, operational procedures, etc. will be used.

### **2.2 LNG cargo**

For the LNG cargo tanks membrane tanks from the French company GTT will be used to get the optimal volume of the LNG tanks in relation with the design of the ship. The GTT membrane technology is a proven technology used at large seagoing LNG vessels. The LNG shall be conditioned, with redundant re-liquefying gas installations to prevent the cargo against warming up. The GTT membrane tanks are type approved by all classification societies including Lloyd’s Register. As these tanks aren’t being used on inland waterway ships yet, and do not fully comply with the present ADN requirements, a recommendation from the ADN Safety Committee is needed.



## 2.3 Membrane tanks

The ship will be built with a double bottom, a double hull, and a double deck. Inside this double hull, the membrane tanks will be placed. These tanks consist of a layer of plywood, 300 mm of glass reinforced poly-urethane foam, a layer of reinforced aluminum foil, a second layer of 100 mm glass reinforced poly-urethane foam, and a layer of 1.2 mm stainless steel.

The two membranes (stainless steel and aluminum foil are both separately leak-controlled by slightly overpressure between these layers. The overpressure is constantly maintained and measured during the whole ships' life. The insulation by the two layers of foam is such that this has no effect on the type of steel used for the ships' structure. The heat transfer from the cargo to the ships' structure has been calculated by GTT and approved by Lloyd's Register.

As the use of these tanks is new for an inland waterway vessel and the type approval is based on seagoing ships, the requirements of the IMO IGC Code has been used as far as useful on an inland waterway vessel. Some parts of the IGC Code however aren't applicable on inland waterway vessels, such as the requirement for partly loaded tanks. On seagoing vessels these requirements make sense due to the occurrence of sloshing in these large tanks. Sloshing however doesn't occur on inland waterway vessels.

During the ships' operations the tanks aren't usually not completely emptied to keep them cold. Only for maintenance or surveys the tanks will be emptied according a procedure as described by GTT. The cooling down of the tanks at the first cargo intake or after a survey will also be done according a procedure from the tank manufacturer.

The tanks can't be considered as being independent from a strength point of view as they needed to be supported by the ships' steel structure. They are considered to be independent for temperature aspects. The tanks can't be considered as being pressure tanks according the ADN as the pressure will not exceed 70 kPa.

As the tanks are placed inside the double hull of the vessel the risk of being damaged by a collision is limited. However, due to the size of the tanks the whole vessel needs to comply with the requirements of ADN 9.3.4. The vessel isn't only equipped with a patented 'Schelde-huid', but also the double hull is 1065 mm, which is more than is needed according legislation.

The calculations according the requirements of ADN 9.3.4 have been made and have showed that the inner hull of the vessel will not be damaged until leakage. The membrane tanks have sufficient flexibility to withstand the deformation of the inner hull of the vessel due to the calculated collisions. So it can be concluded that the risk of leakage due to a collision isn't worse as on a vessel with conventional gas tanks.

## 2.4 Stability

The ship fully complies with the stability requirements of the ADN.

The LNG will be carried in tanks with a large breadth, but the free surface moment is included in the ships' stability, and this doesn't lead to a large reduction in stability due to the light density of the LNG. The gasoil tanks are divided in a PS and SB tank with a bulkhead in between, so their contribution to the free surface moment is limited (but has of course be taken into account).





## 2.5 Compliance with the ADN

Apart from the following items the vessel fully complies with the ADN 2015. This applies for the technical lay-out of the vessel, as well as on the operational issues.

1. Table C, UN 1972 (LNG), Column 7, cargo tank design: 1 (pressure tank). Although the membrane tank is a pressurized tank (70 kPa), it doesn't comply with the definition of a pressure tank according ADN 1.2.1. "Pressure tank" ( $\geq 400$  kPa).
2. Table C, UN 1972 (LNG), Column 8, cargo tank type: 1 (independent tank). Although the tank is independent from the ships' structure involving the temperature (no cold transfer from the cargo to the vessel), it isn't independent from a structural point of view.
3. 9.3.1.0.1 (a) Material of cargo tanks: The membrane tanks are made of plywood, polyurethane foam, aluminum foil and stainless steel.
4. 9.3.1.0.2 Use of wood, aluminum and plastics in the cargo zone. The membrane tanks are made of plywood, polyurethane foam, aluminum foil and stainless steel. However, it can be noted that also on conventional type G tankers the insulation is made of polyurethane foam.
5. 9.3.1.23.1 Cargo tanks need to comply with the requirements of a classification society for pressure vessels. As the tanks are not considered to be pressurized tanks, these requirements aren't applicable. But the membrane tanks are type approved by the classification society which classes the ship (Lloyd's Register) and other recognized classification societies. The type approval conditions are fully complied with.



### 3. Questions following the meeting of the Expert Group

During the meeting of the Expert Group “Bunker Vessel Argos-GL” several issues arose. Some additional questions were raised by several delegates by email. These are answered below.

- I. *Transition of the requirement for seagoing vessels, that the cargo tanks never shall be partially filled,*
  - *to avoid damages of the membrane by sloshing;*
  - *stability and integrity of the tanks in comparison to steel tanks.*
  - *safety in case of collisions;*
  - *different scenario compared with sea navigation, effects of the release of 935 m<sup>3</sup> LNG in the narrow river valleys or on the channels between settlement and industrial areas.*

#### Sloshing

The membrane to be used on the Argos vessel is tested and approved for use on seagoing vessels and the impact of sloshing at sea. The possible sloshing on inland vessels is minor compared with seagoing vessels. Therefore the possibility of the membrane or the integrity of the tanks being damaged when used on inland vessels on inland waterways is very slim, and less than on type C tankers due to the low density of LNG.

#### Stability

The bunker vessel fully complies with the current provisions on stability. No difference occurs in comparison with other carried liquids.

#### Integrity of the tank

The membrane tanks have been tested on the possibility of being ruptured during collision. The way the membrane is fixed to the vessels structure allows for flexible tanks, which are to a large extent resisted to deformation. In addition, in case the tank indeed would get ruptured it could be considered more safe than a pressure tank. In comparison to a regular type G tank the pressure inside the membrane tank is much lower. After a rupture there's no high pressure gas vapor release by the tank.

#### Effects of release of large amounts of LNG on the waterface

The effects of LNG on the surface of the water are well studied, also during the informal working groups on the carriage of LNG in 2013. Any LNG released will be heated by the water. Rapid phase transitions will occur and the LNG will evaporate.

In comparison to other substances allowed to be carried in tanks larger than average, for example LPG, LNG could be considered the safer substance. LPG is heavier than air and will remain on the water surface. Also, LNG is not easy to ignite as it's explosion range is small in comparison to LPG for example.



II. *ADN 9.3.4.2, Alternative constructions, use of large cargo tanks, possibility of rupture*

The strength of the vessel has been calculated according ADN 9.3.4. and fully compliance with these requirements has been shown. The vessel will be equipped with a 'Schelde huid', a patented construction which is applied on other IWW tankers as well.

During the presentation of GTT results of large scale test on the strength of the membrane tanks will be shown.

III. *In case of accidents or incidents the scenario of interaction between the cargo tanks for gasoil and the cargo tanks for LNG: for example fire and explosion in the gasoil tanks or rupture of LNG tanks and release of LNG to the shells of the gasoil cargo tanks below the deck.*

The construction of the vessel is of course in compliance with the AND for the carriage of both gasoil and LNG. The consequences of an explosion on the proposed vessel are from a structural point of view no different to a vessel which is carrying only gasoil. The only difference would be the possible interaction between gasoil and LNG. There is however no evidence this would cause any additional hazards.

IV. *Construction of the vessel;*

The vessel complies with both the provisions relevant for the carriage of gasoil and the provisions for the carriage of LNG. The whole vessel will be equipped as a type G tanker as the requirements for this type are of a higher standard. (See also question IX)

V. *Operational issues: immediate availability of boat masters with ADN-Certificate for Type G tankers in bunkering enterprise; constant partially filling of the LNG tank to keep the low temperature.*

Indeed, the vessel is carrying LNG. All the provisions in the ADN for the carriage of refrigerated substances have to be complied with. The manning of the vessel seems to be no issue according the operator.

VI. *Taking fuel for the vessels engine from the LNG cargo tanks: allowance of connections between the LNG cargo tank and the LNG fuel tank for the vessels engine: 7.2.4.9, 7.2.4.22 (= opening of openings of cargo tanks), 7.2.5.25.1 ADN.*

There is no connection from the LNG cargo tanks to the LNG storage tank for the ships' propulsion.



VII. *The use of a of electric motors inside the cargo tanks.*

The concept of proposed vessel has been changed, and the use of electric motors inside the cargo tank have been abandoned.

IX. *The ship will be a combined type N and type G tanker. Will the instrumentation for the Type N tanks be of the same standard as for the type G tanks? Will the type N operations be clearly separated from the type G operations without interference?*

The whole vessel will be equipped as a type G tanker as the requirements for this type are of a higher standard.

The operations will be clearly separated. The vessel will be equipped with two sets of piping: one for the gasoil and one for the LNG. Also the bunker crane will be equipped with two separate lines, which are in no way connected. The bunker line for both the gasoil and the LNG are equipped with the required safety measures involving explosion safety. The bunker line for LNG is insulated from the structure of the crane to avoid cold transfer and any possibility of brittle fracture.

XI. *The bunker crane will be used for LNG bunkering. The moving of the crane will create a moving zone with explosion risk around it. How will this be taken into account?*

This issue is taken into account. Any electrical equipment on the bunker crane will be of an "explosion-safe"-type.

XII. *Conventional bunker ships have a rapid closing device in accordance with ADN 9.3.3.21.5.c. Does this ship have a similar device in the LNG bunker line?*

Yes.

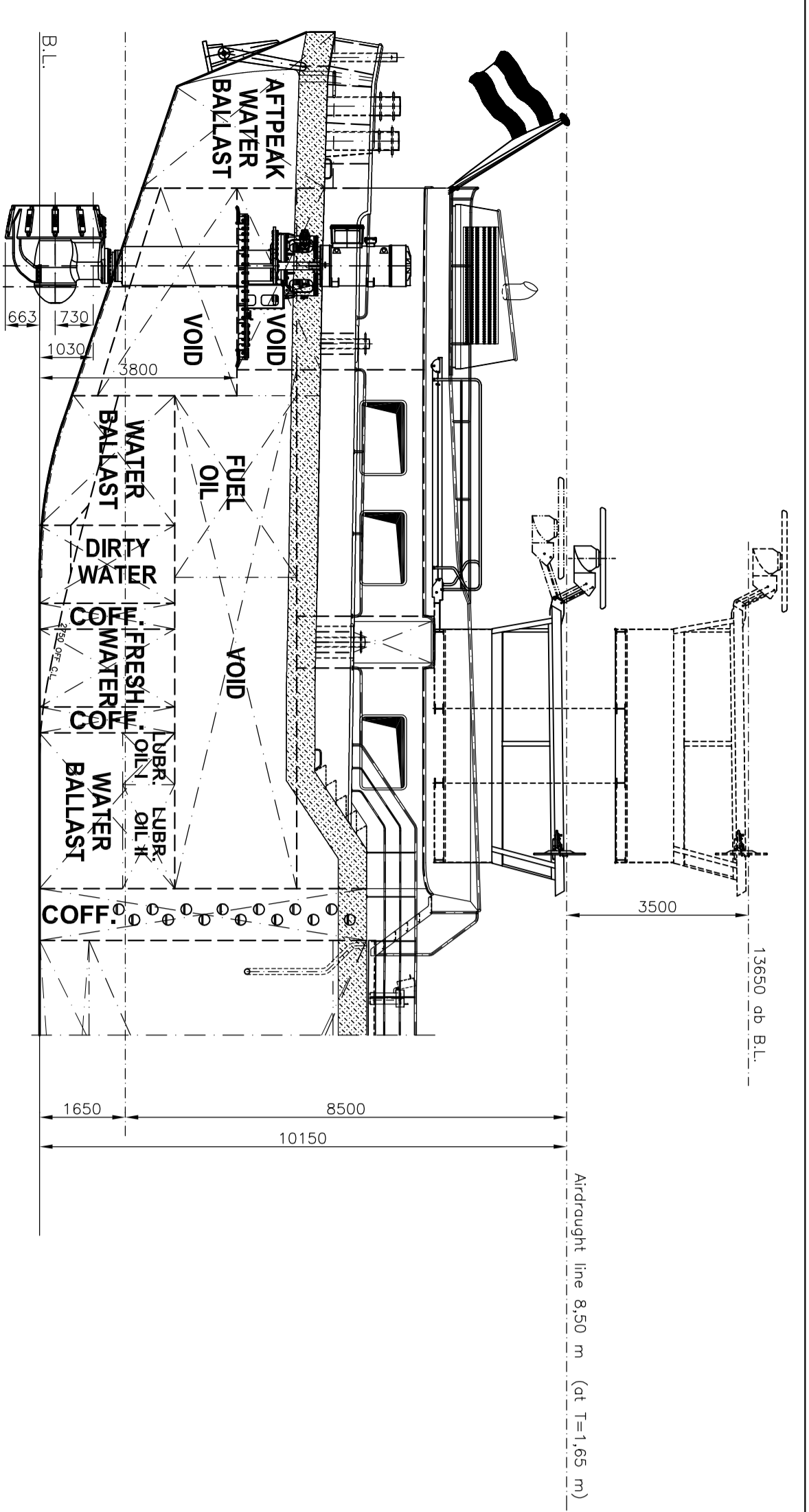

# ARGOS – LNG & GAS OIL BUNKERING LNG PROPULSION

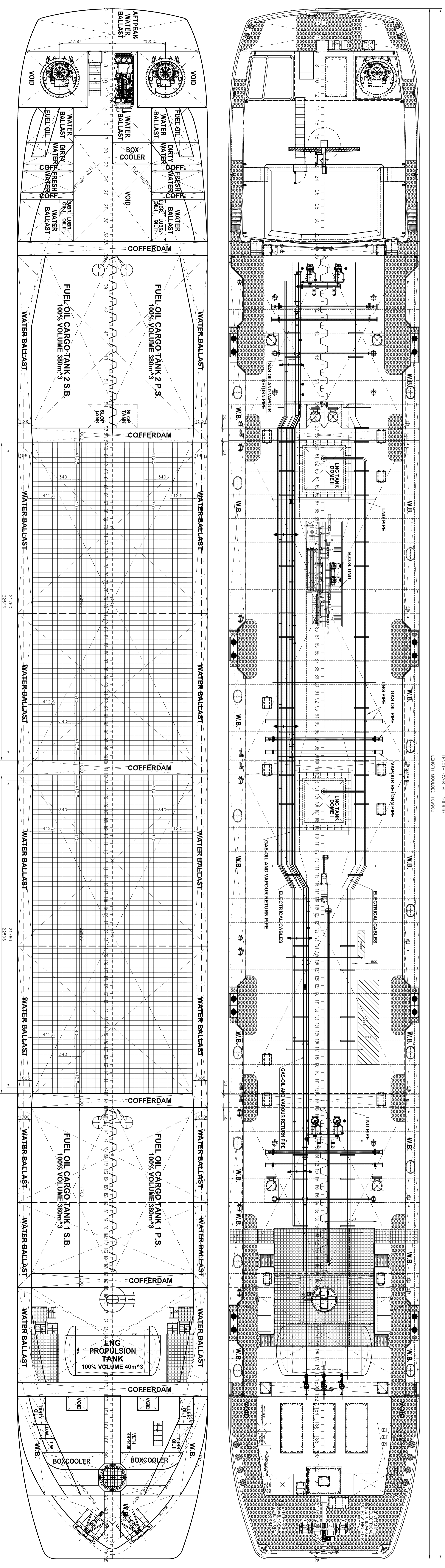
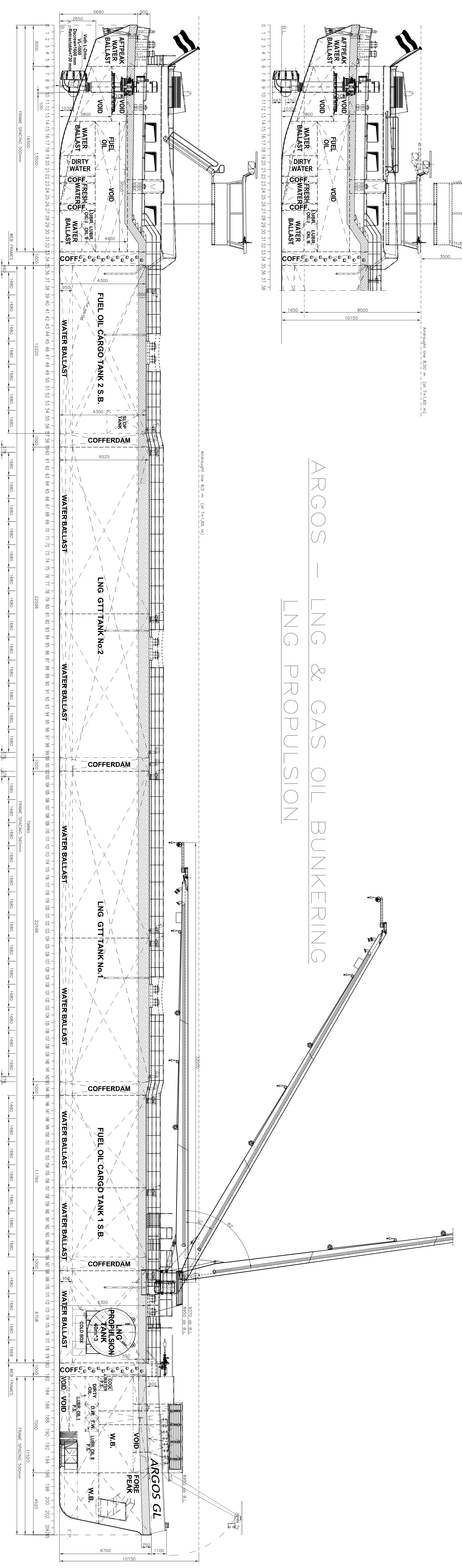

### MAIN PARTICULARS

LENGTH O.A. (+2x20mm SHEETSPACE)	109.94	m
LENGTH M.D.	109.90	m
BREADTH M.D.	13.50	m
BREADTH O.A. (+2x20mm SHEETSPACE)	13.54	m
DEPTH M.D.	6.30/6.325	m
SCANTLING DEPTH	4.50	m
AIR DRAUGHT MAX. (at T=1.65m)	8.50	m

### CLASSIFICATION Lloyd's Register

CLASS NOTATION:  
 \*A1 LNW Tanker Type G, p.v. +70 kPa, SG 0.5, in association with a List of Defined Carriage.  
 Zone 2 "LS" "D", with the descriptive note: "Gas tanks designed for the carriage of LNG at -165°C".  
 Part of the cargo zone built as Tanker Type G, p.v. +50 kPa, SG 1.0, in association with a List of Defined Carriage.

### CARGO ARRANGEMENT

LNG GTT BUNKER TANKS	
NUMBER OF LNG BUNKER TANKS	2
VOLUME 100%	935 m <sup>3</sup> x 2 = 1870 m <sup>3</sup>
VOLUME 97%	850 m <sup>3</sup> x 2 = 1700 m <sup>3</sup>
FUEL OIL BUNKER TANKS	
NUMBER OF FUEL OIL BUNKER TANKS	4
VOLUME 100%	380 m <sup>3</sup> x 4 = 1520 m <sup>3</sup>
VOLUME 97%	388 m <sup>3</sup> x 4 = 1547 m <sup>3</sup>

REV.	DATE	DRAWN	DESCRIPTION

Copyright of Rommerts Ship Design B.V. All rights reserved. No part thereof may be reproduced, stored, distributed or in any other way made available to the public without the prior written permission of Rommerts Ship Design B.V.

ROMMERTS SHIP DESIGN  
 Argos Group B.V.

LNG & FUEL OIL BUNKER TANKER – m/s "ARGOS CL"  
 GENERAL ARRANGEMENT (GTT TANKS)  
 SCALE 1:100  
 SHEET NO. 10  
 SHEETS 1

DATE: 14.10.2014  
 SHEET NO.: 10  
 SHEETS: 1



# **MKIII Containment System**

## **Building principle**

### ***Training Session 2014***

March 13th. 2014

Safety

Excellence

Innovation

Teamwork

Transparency

# AGENDA

- ▶ **Mark III design concept**
- ▶ **System description**
- ▶ **Combined dome**
- ▶ **Mark III Flex**

# AGENDA

- ▶ **Mark III design concept**
- ▶ System description
- ▶ Combined dome
- ▶ Mark III Flex



# Mark III design concept

## The corrugated stainless steel primary barrier:

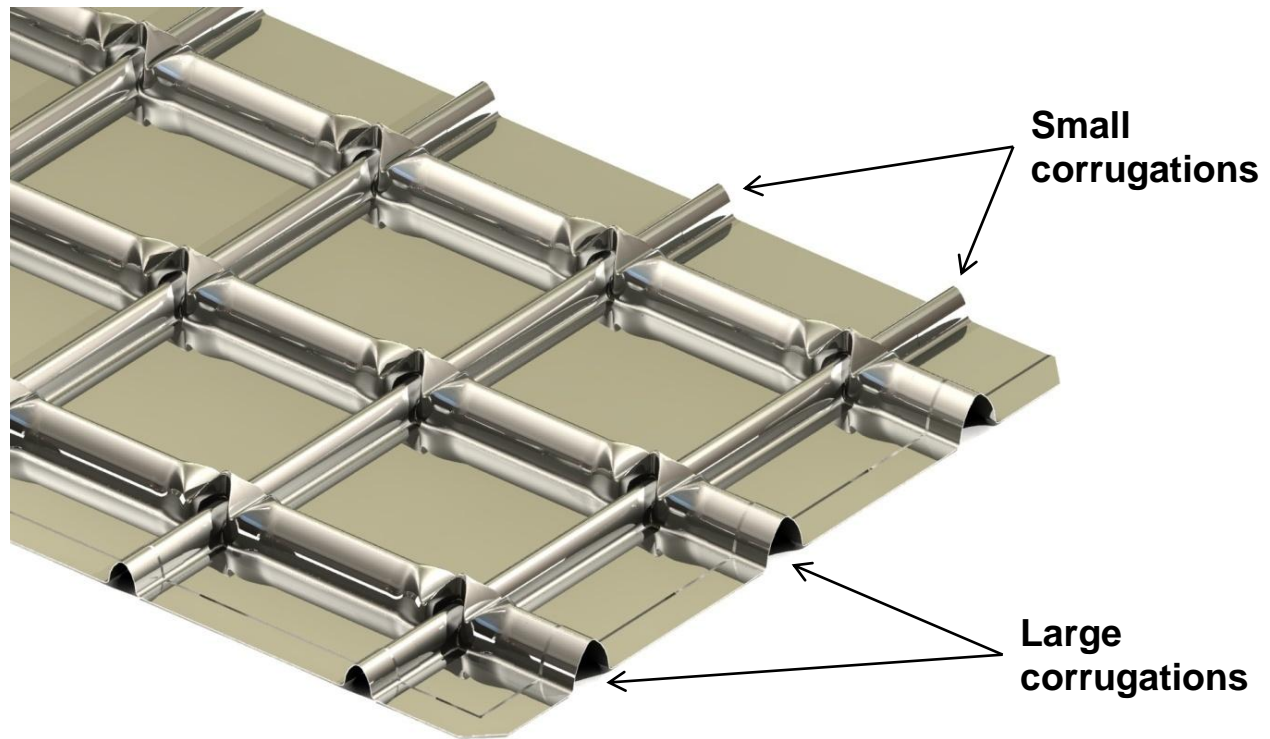

- ▶ Standard pitch : 340mm
- ▶ Thickness : 1.2mm
- ▶ Material : Stainless Steel 304L

# Mark III design concept

## The insulation panel

- ▶ it is a prefabricated component integrating the two insulation layers and the secondary barrier and on top of which the primary barrier is welded.

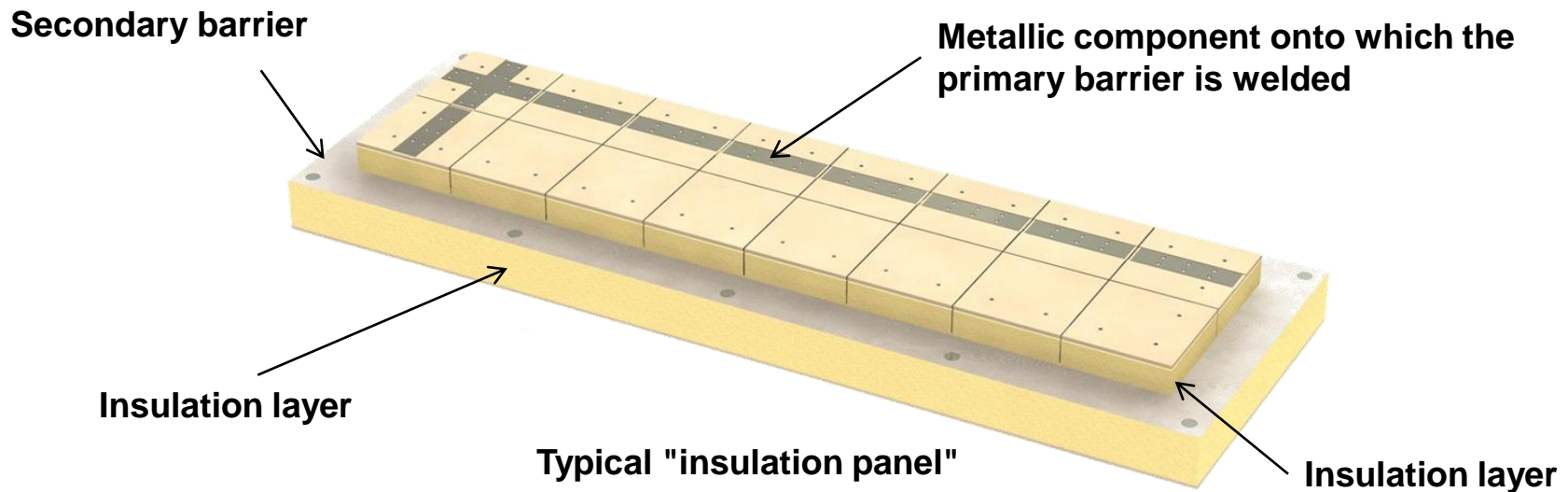

# Mark III design concept

The insulation panel components are made out of:

- ▶ **Secondary barrier: composite material named “Triplex”**
  - ▶ Material: aluminum foil bonded between two glass clothes
  - ▶ Versions: flexible band (named FSB) or rigid foil (named RSB)
- ▶ **Insulating material:**
  - ▶ reinforced polyurethane foam ("R-PUF")
  - ▶ Density: 120 / 130 Kg.m-3
  - ▶ Reinforcement: 10% glass fiber, in weight

# Mark III design concept

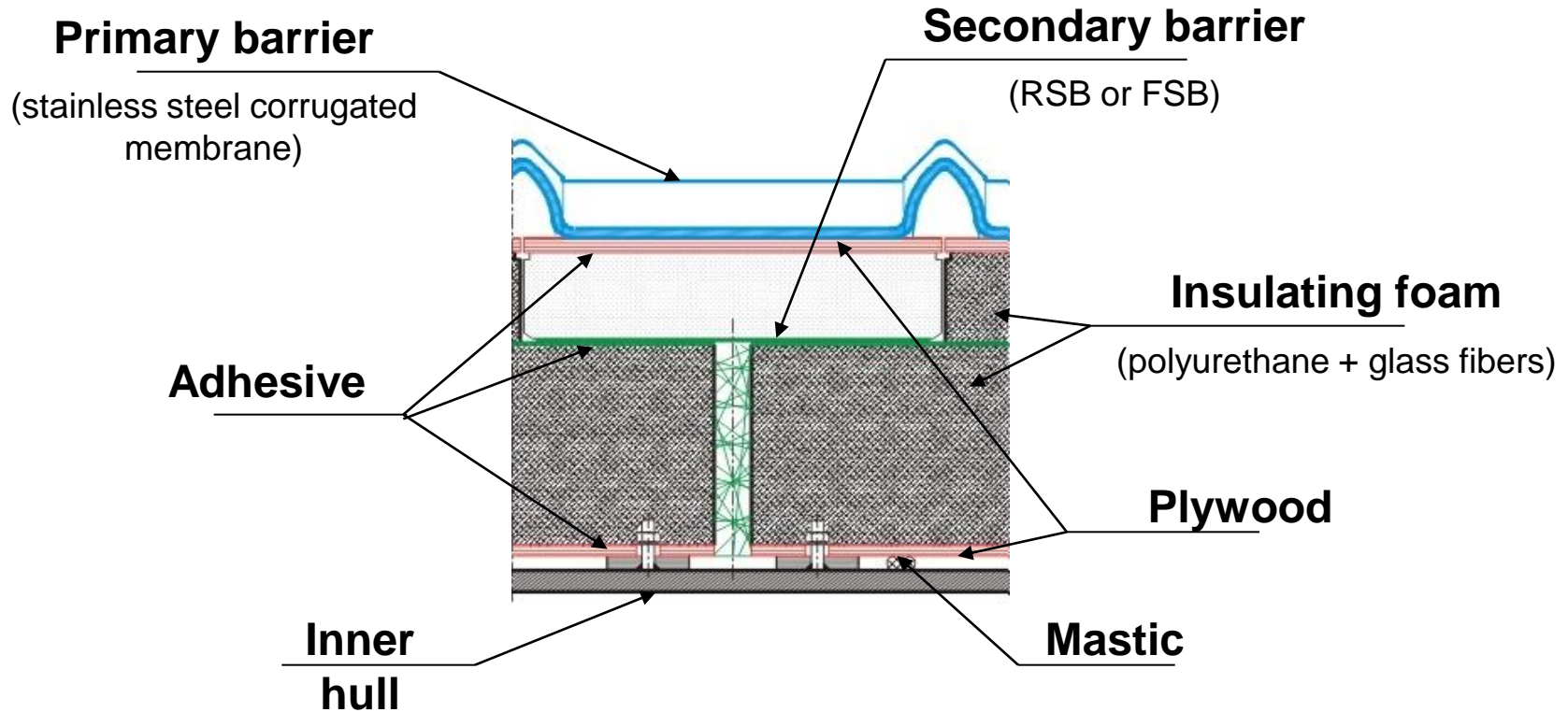

# Mark III design concept

## ► Thickness of the insulation

- Dedicated part for Mark III Flex at the end of the presentation

MARK III  
270mm

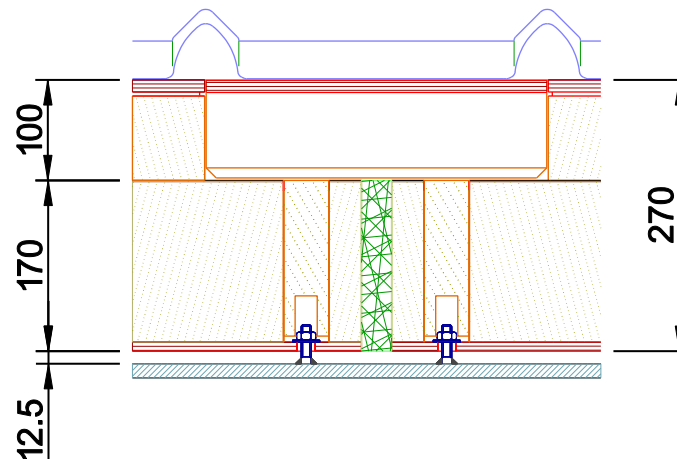

# Mark III design concept

- ▶ **The Mark III components are:**
  - ▶ highly standardized: low number of parts references
  - ▶ highly prefabricated in workshop: ready-to-use
- ▶ **The Mark III containment system mounting procedure is highly automated: reduced number of manual operations**

# AGENDA

- ▶ Mark III design concept
- ▶ **System description**
- ▶ Combined dome
- ▶ Mark III Flex

# AGENDA

- ▶ Mark III design concept
- ▶ **System description**
  - The flat wall area**
    - The dihedron
    - The trihedron
    - Completion of the insulation
    - The primary barrier
  - ▶ Combined dome
  - ▶ Mark III Flex



# System description – the flat wall area

## ▶ The flat wall area

- ▶ The flat wall area is everywhere in the tank, except for the corners and the special areas

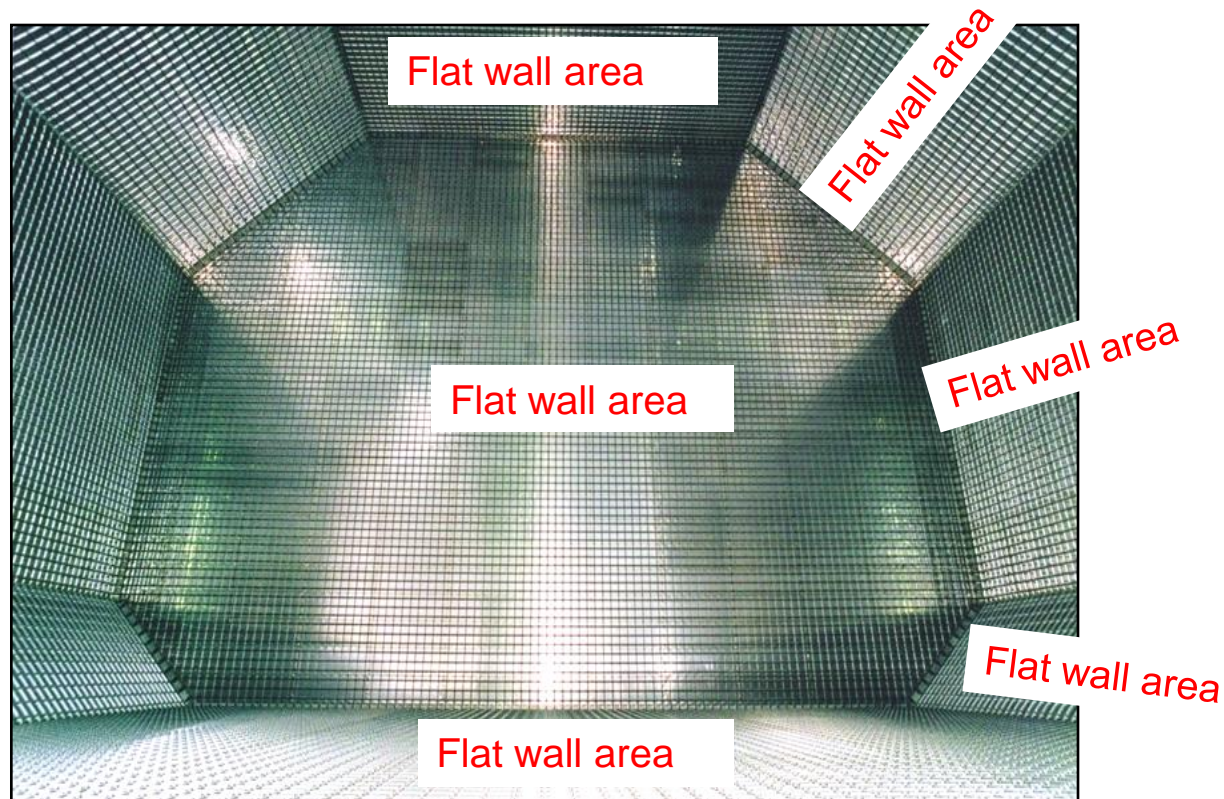

# System description – the flat wall area

- ▶ The main component of the flat wall area is the "Flat Panel".
  - ▶ It represents about 90% of all insulation panels used in a tank.

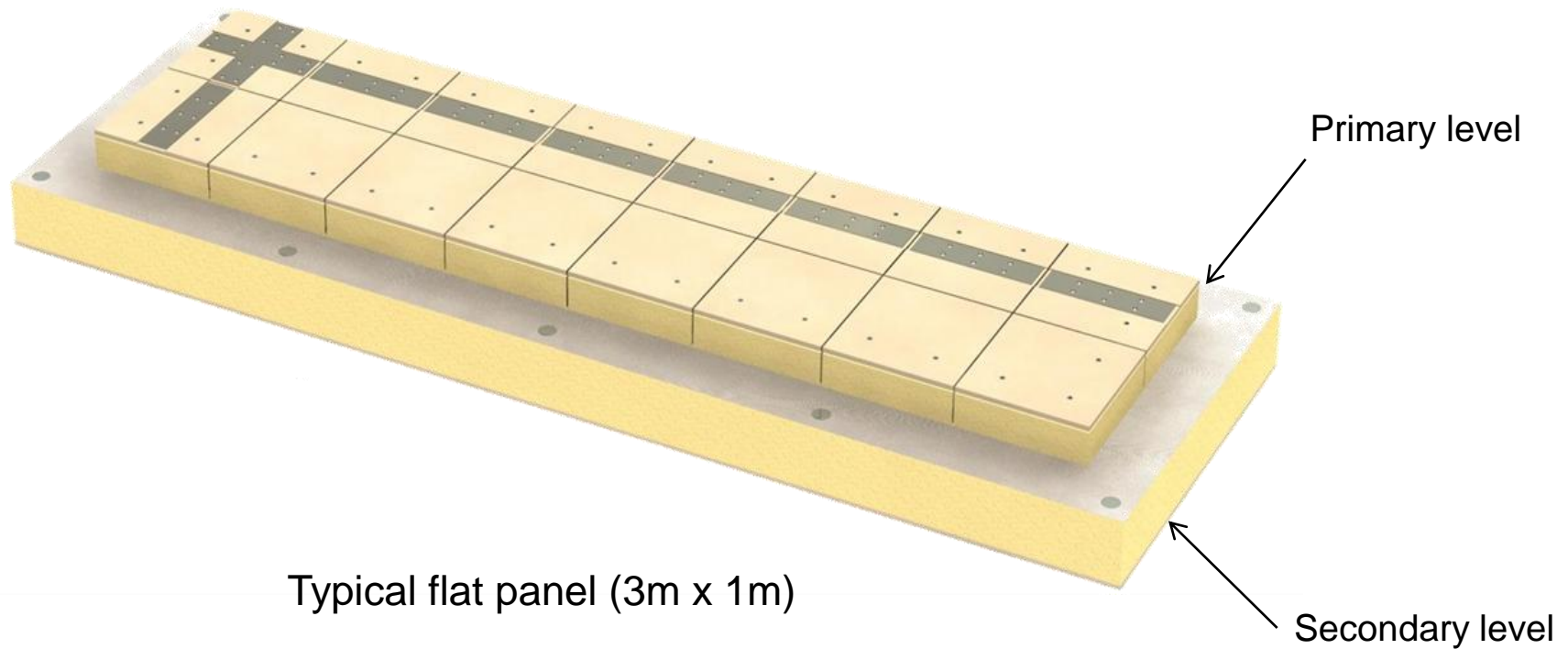

# System description – the flat wall area

## ► The flat panel is a sandwich of several layers

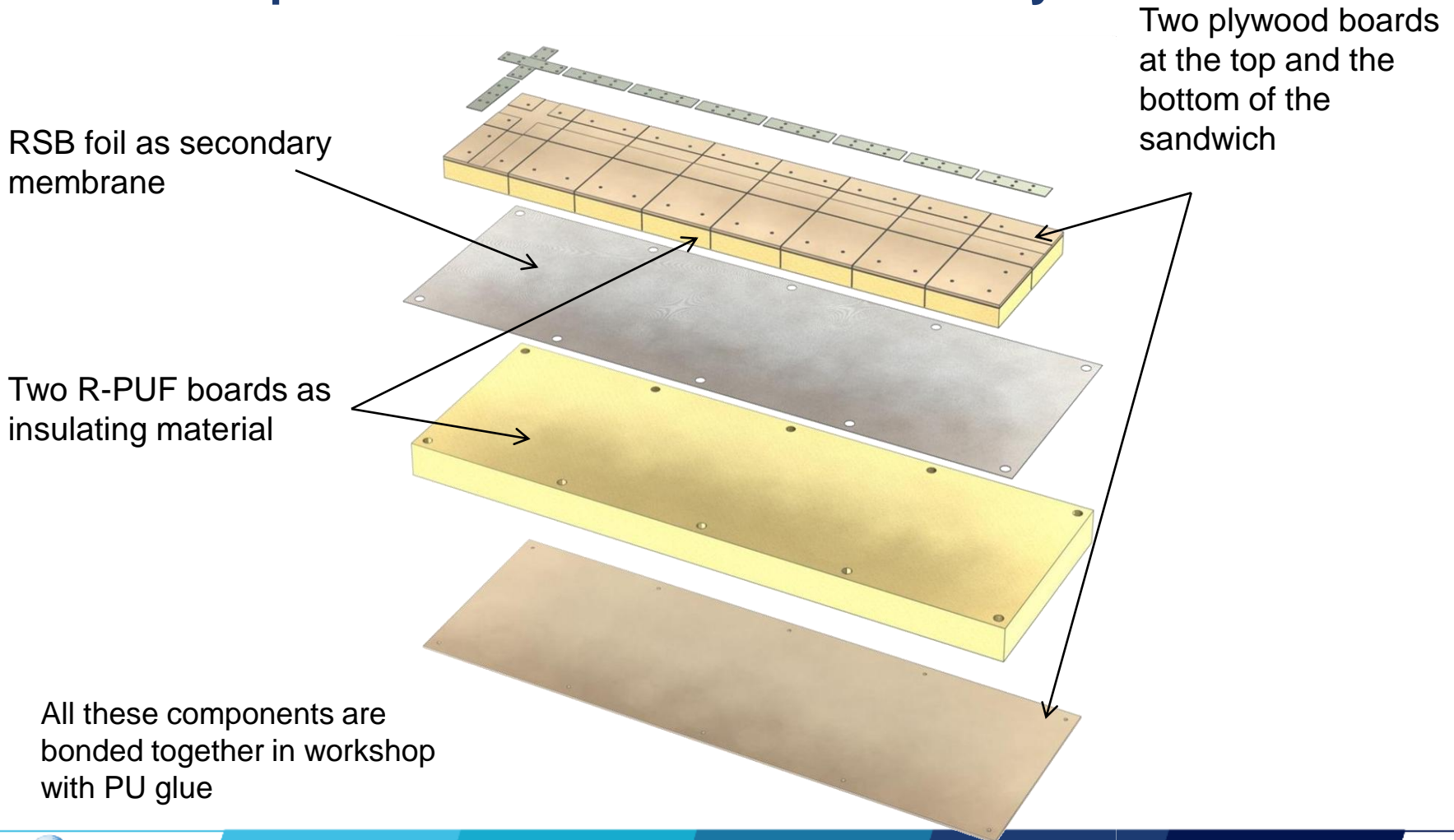

# System description – the flat wall area

- ▶ **The flat panel is a sandwich of several layers**

Finally, stainless steel anchoring strips, riveted to the top plywood, onto which the primary membrane will be welded

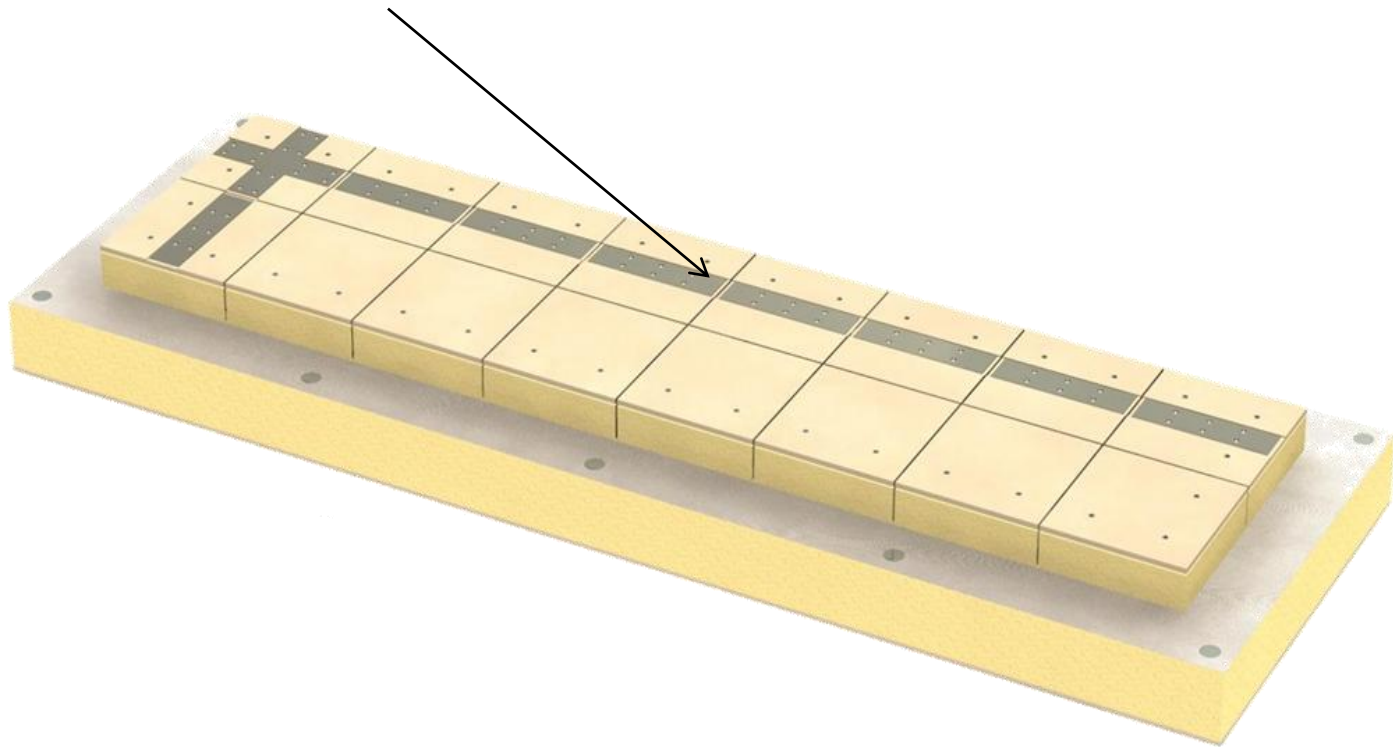

# System description – the flat wall area

- ▶ The flat wall area: flat panels in their context

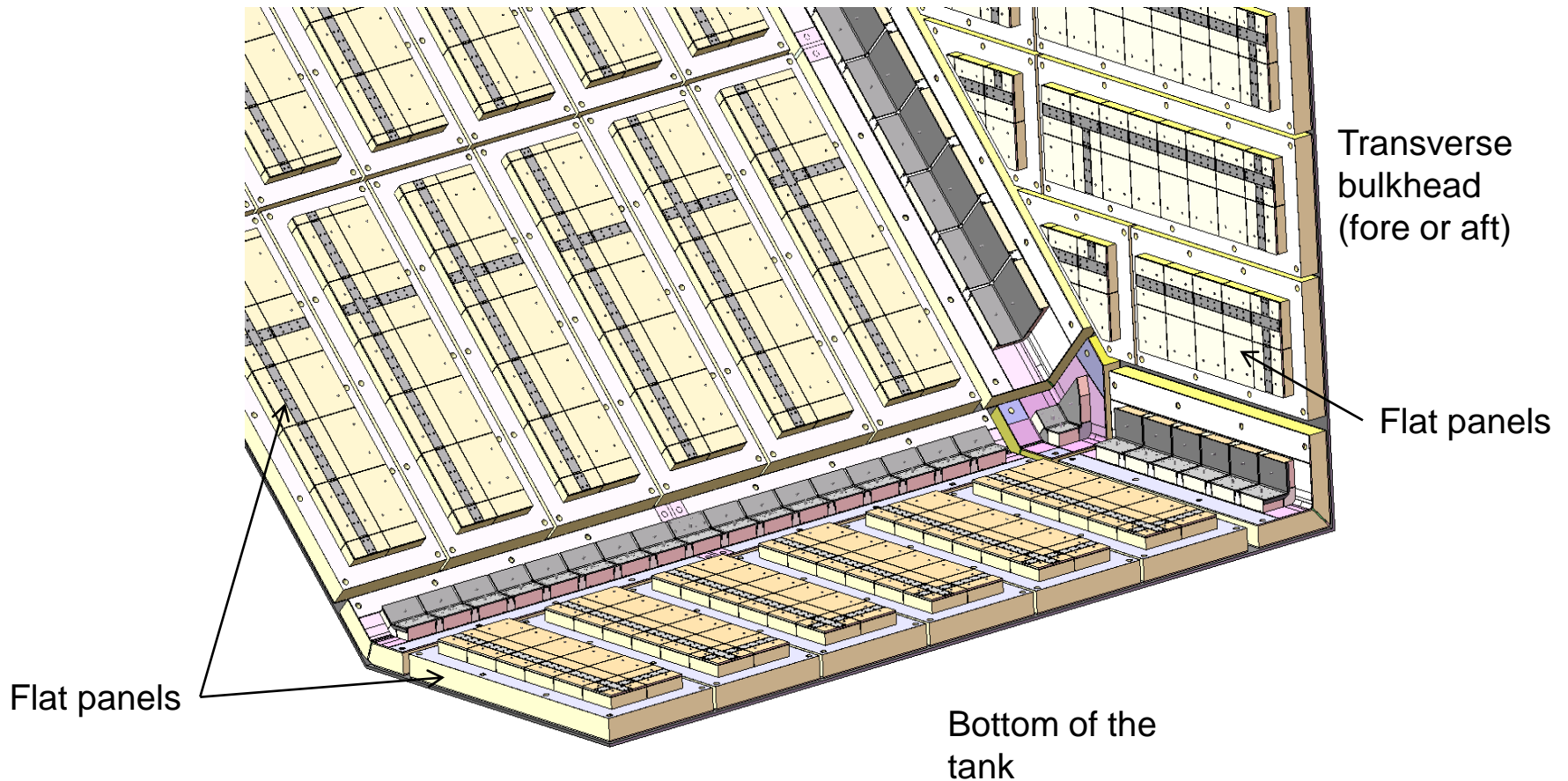

# ***AGENDA***

▶ Mark III design concept

▶ **System description**

The flat wall area

**The dihedron**

The trihedron

Completion of the insulation

The primary barrier

▶ Combined dome

▶ Mark III Flex

# System description – the dihedron

## ▶ The dihedron

- ▶ It's the intersection of 2 tank faces

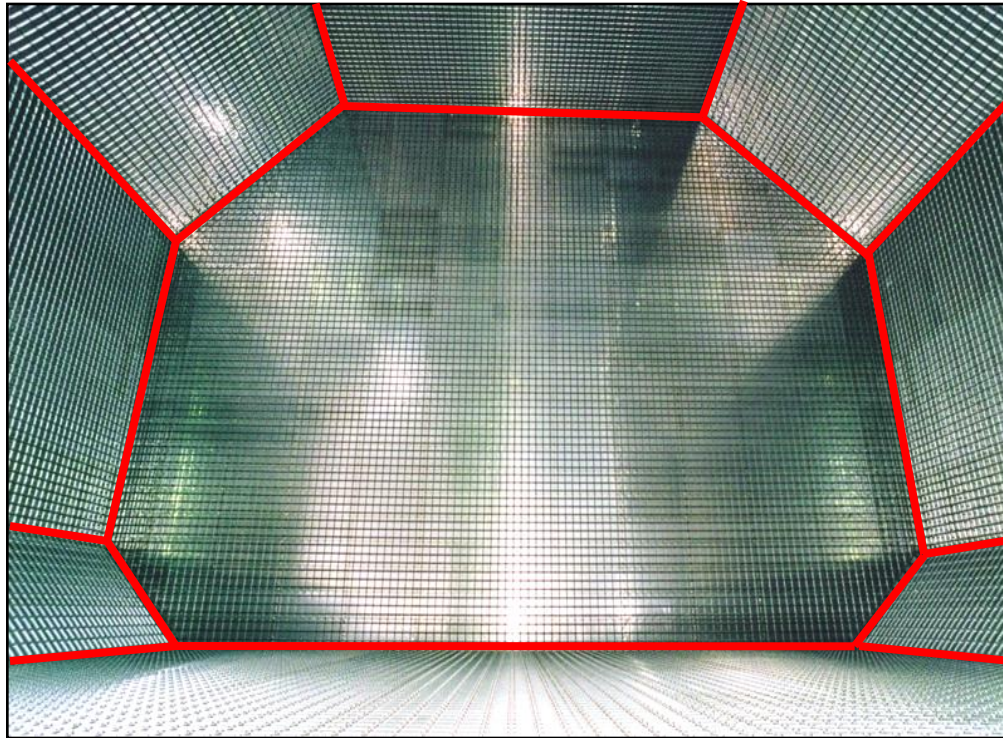

# System description – the dihedron

- ▶ There are several different dihedron angles (90deg, 135deg, 108.4deg...)
- ▶ The two more common angles being 90deg and 135deg.

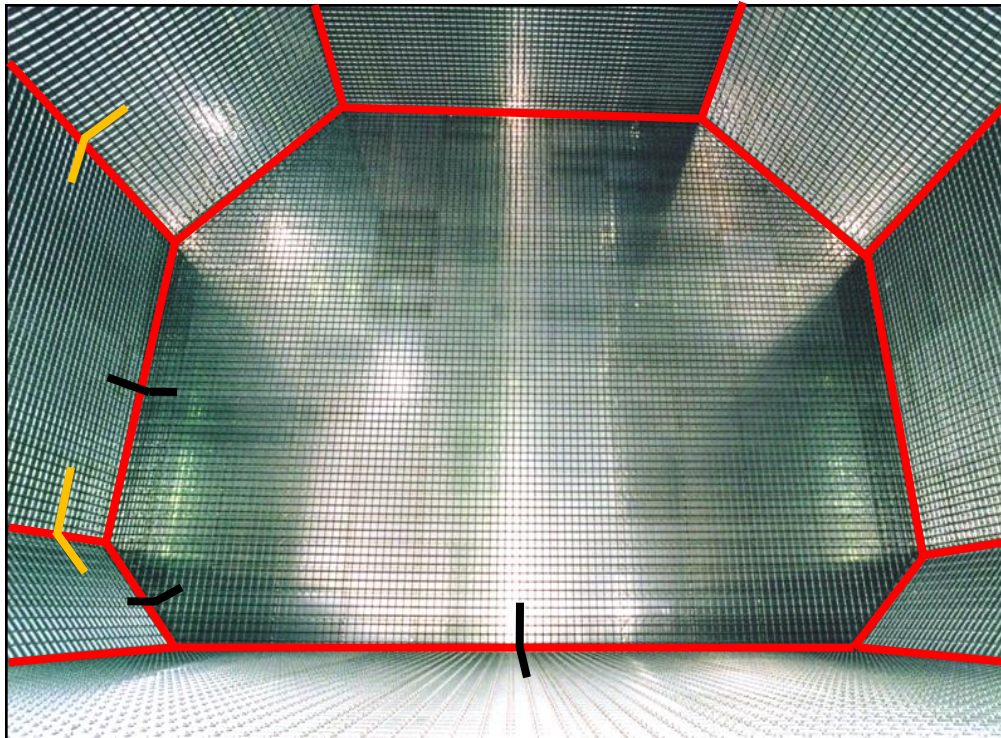

90deg dihedron:

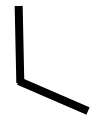

135deg dihedron:





# System description – the dihedron

- ▶ The insulation panel of the dihedron is called "Corner Panel"

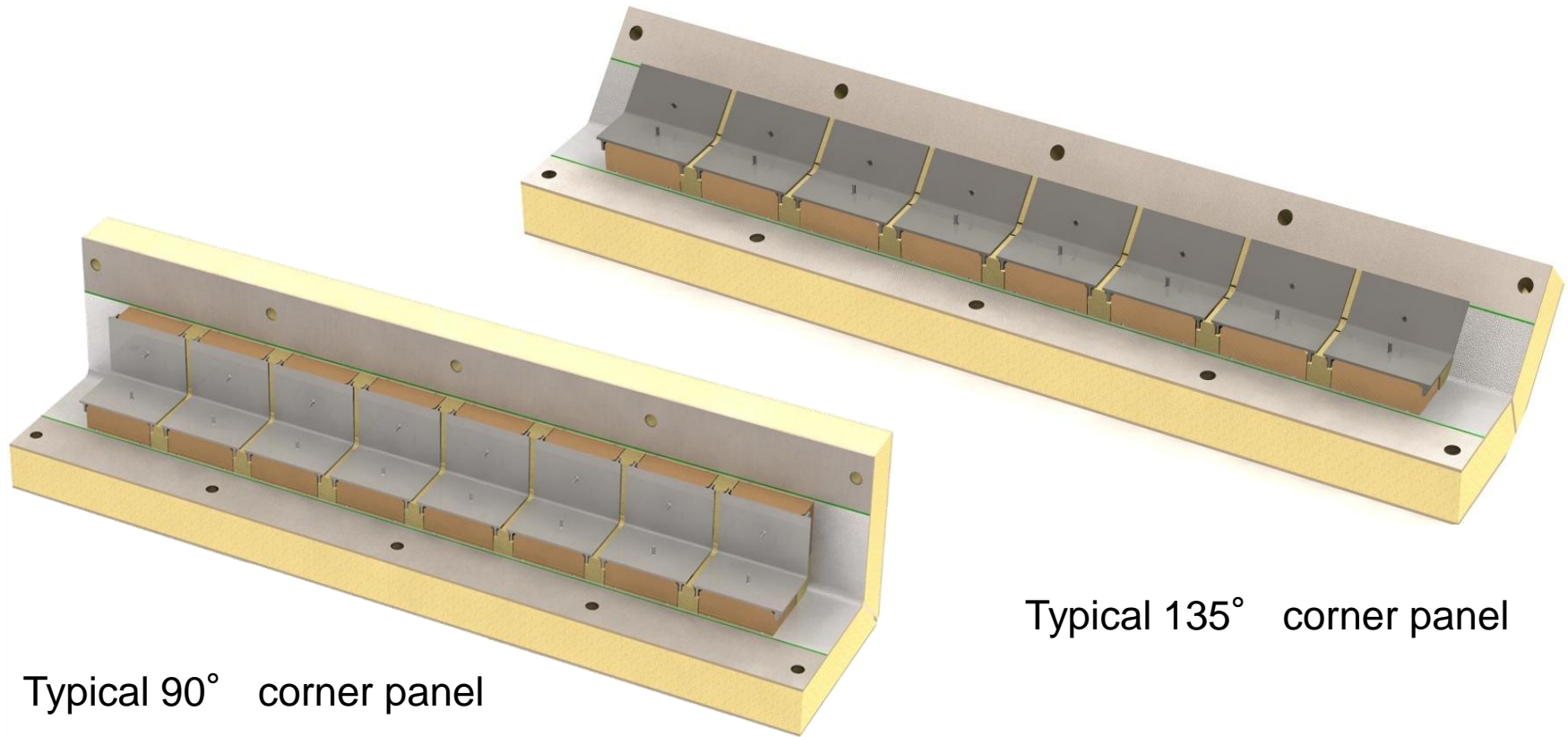

Typical 90° corner panel

Typical 135° corner panel

# System description – the dihedron

- ▶ The corner panel structure is slightly different from the flat panel one.

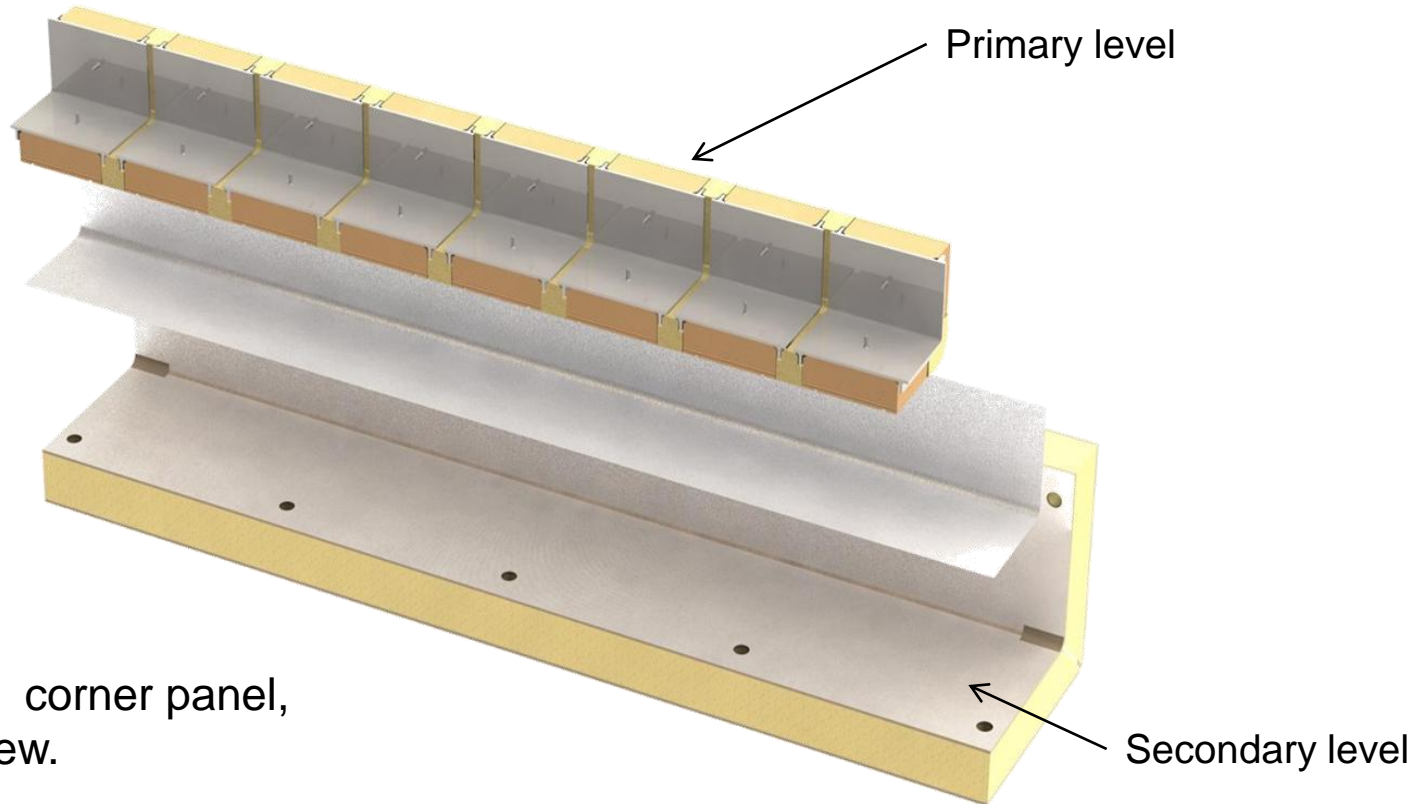

Typical 90° corner panel, exploded view.

# System description – the dihedron

- ▶ The secondary level of the corner panel is a sandwich of:
  - ▶ RSB
  - ▶ Plywood
  - ▶ Foam
  - ▶ Plywood

An RSB foil as secondary membrane

Two plywood boards at the top and the bottom of the sandwich

One R-PUF board as secondary insulation

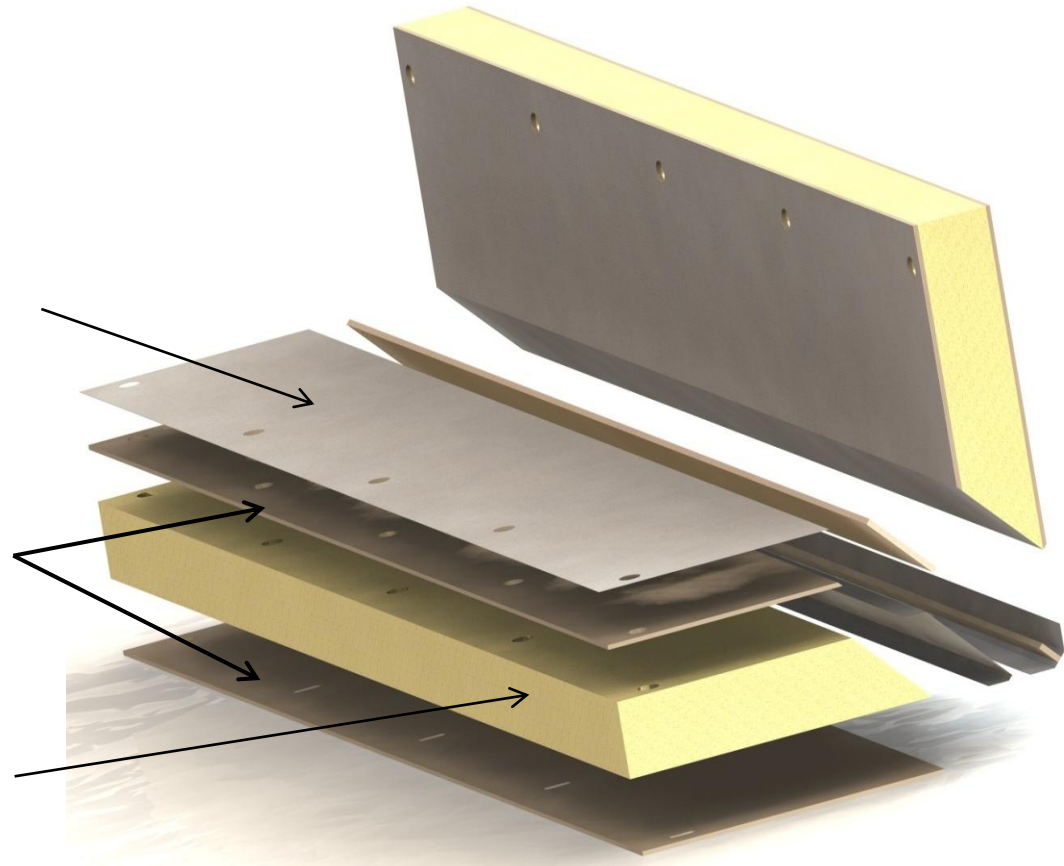

# System description – the dihedron

- ▶ **The primary level of the corner panel is a bolted assembly of 3 parts:**
  - ▶ 1 thick stainless steel folded sheet (the "Steel Corner")
  - ▶ 2 thick plywood pieces

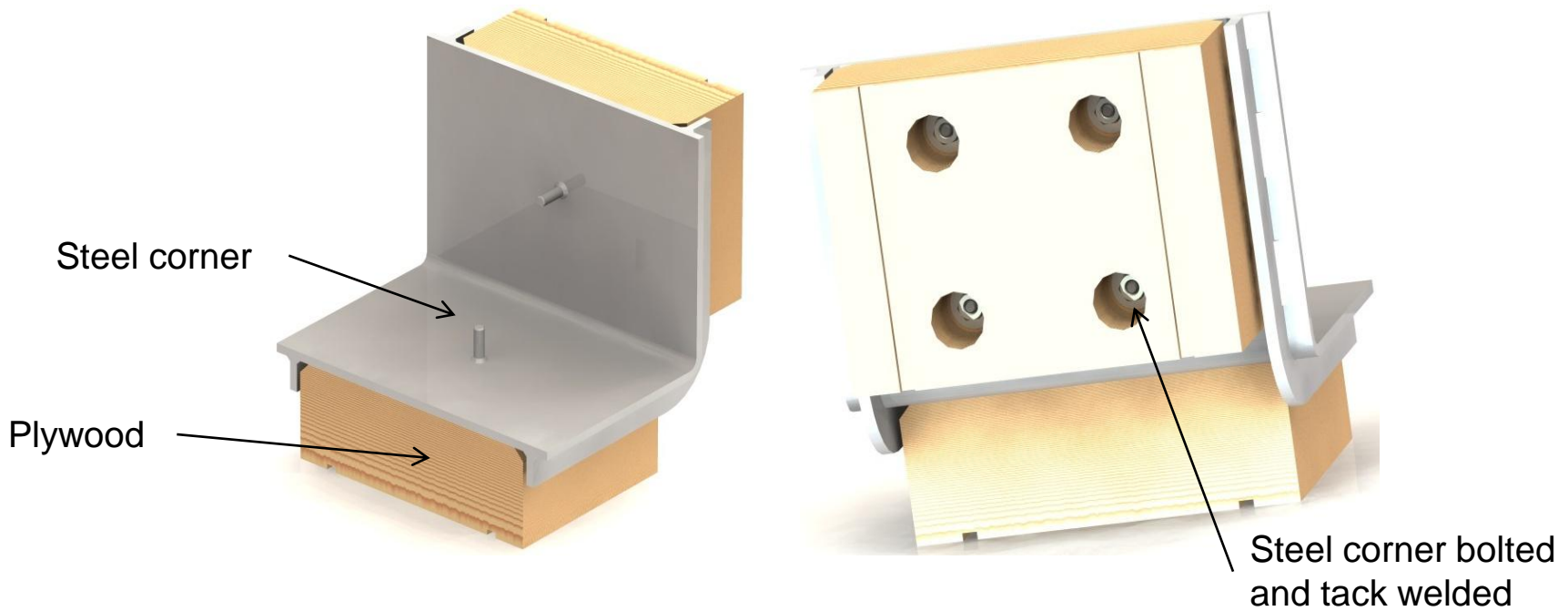

# System description – the dihedron

- ▶ The primary and secondary levels are bonded with epoxy or PU glue to form the corner panel
- ▶ FSB scab is bonded between the secondary and the primary level, to ensure the secondary membrane continuity in the angle

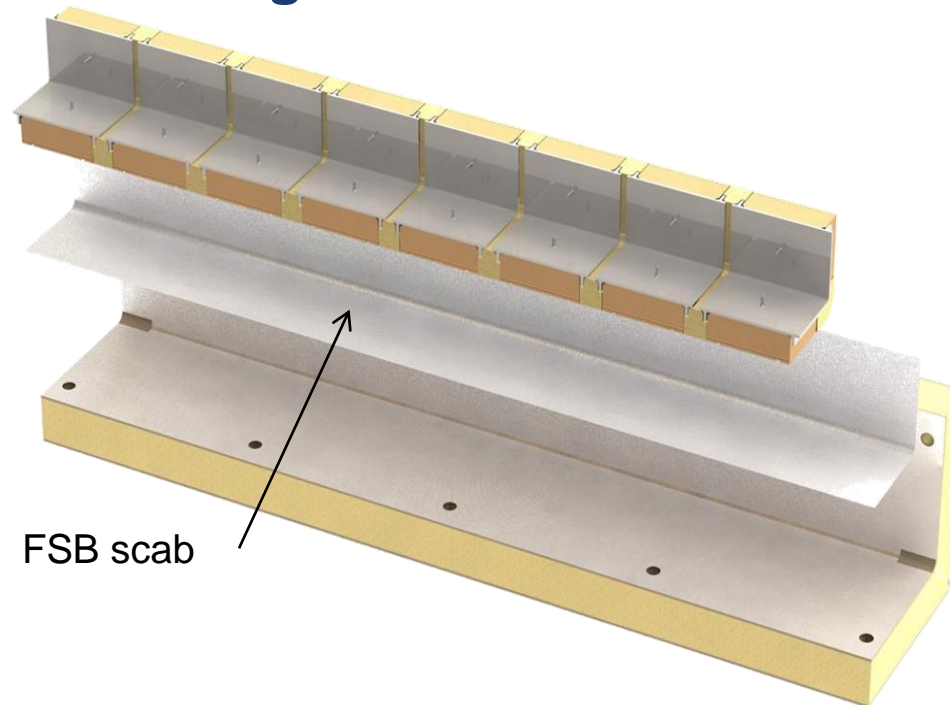

# System description – the dihedron

- ▶ The insulation is completed with R-PUF elements

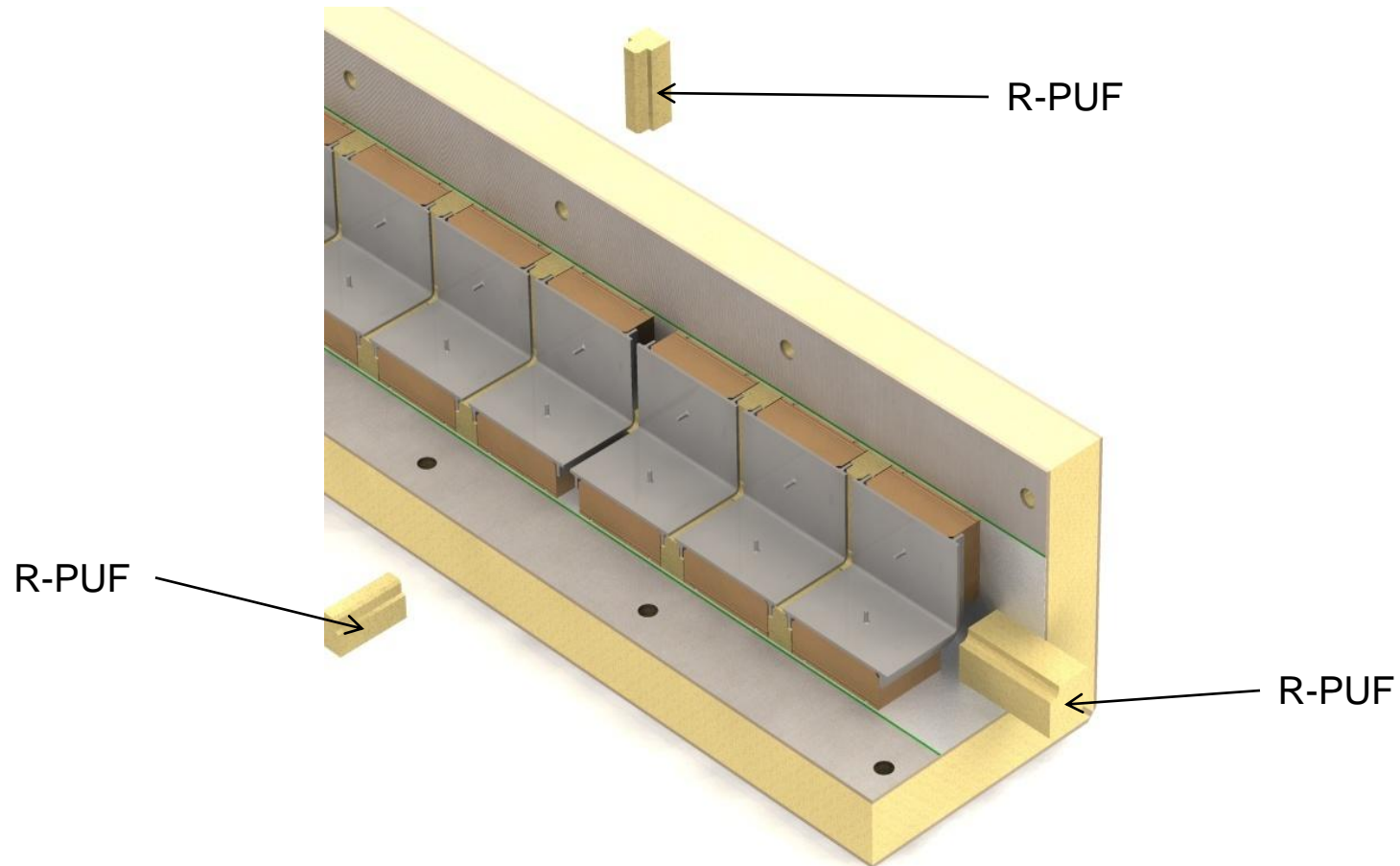

# System description – the dihedron

- ▶ The dihedron: corner panels in their context

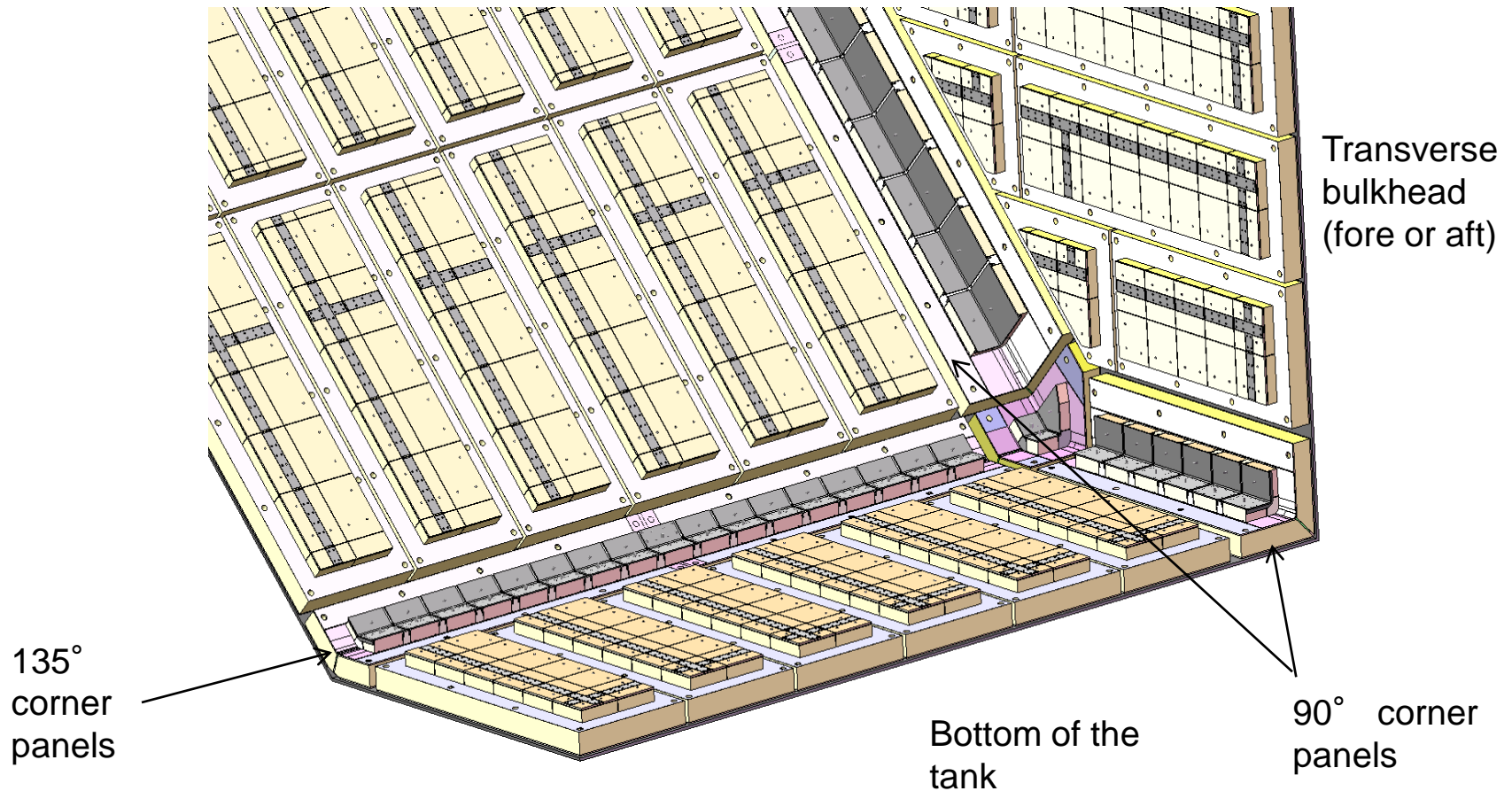

# AGENDA

- ▶ Mark III design concept
- ▶ **System description**
  - The flat wall area
  - The dihedron
  - The trihedron**
  - Completion of the insulation
  - The primary barrier
- ▶ Combined dome
- ▶ Mark III Flex



# System description – the trihedron

## ▶ The trihedron

- ▶ It's the intersection of 3 tank faces

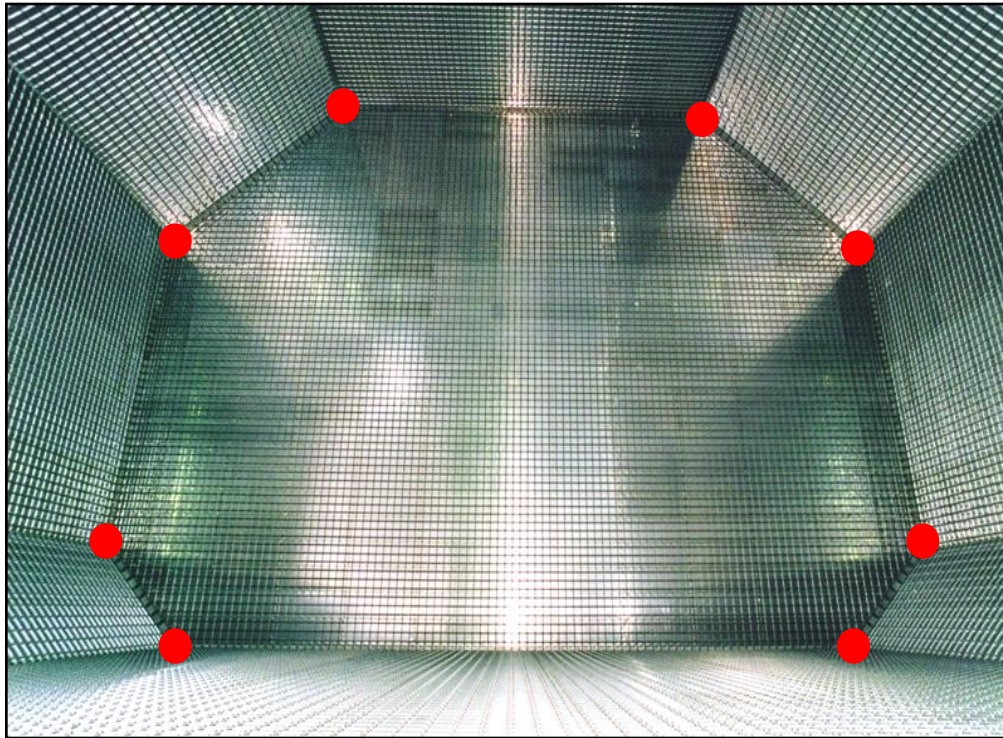

# System description – the trihedron

- ▶ **The insulation panel in the trihedron area is called a "Trihedron" or "Three-way panel"**
- ▶ The trihedron panel structure is very similar to the one of a corner panel,
- ▶ The parts are bonded using the same glues as for a corner panel.

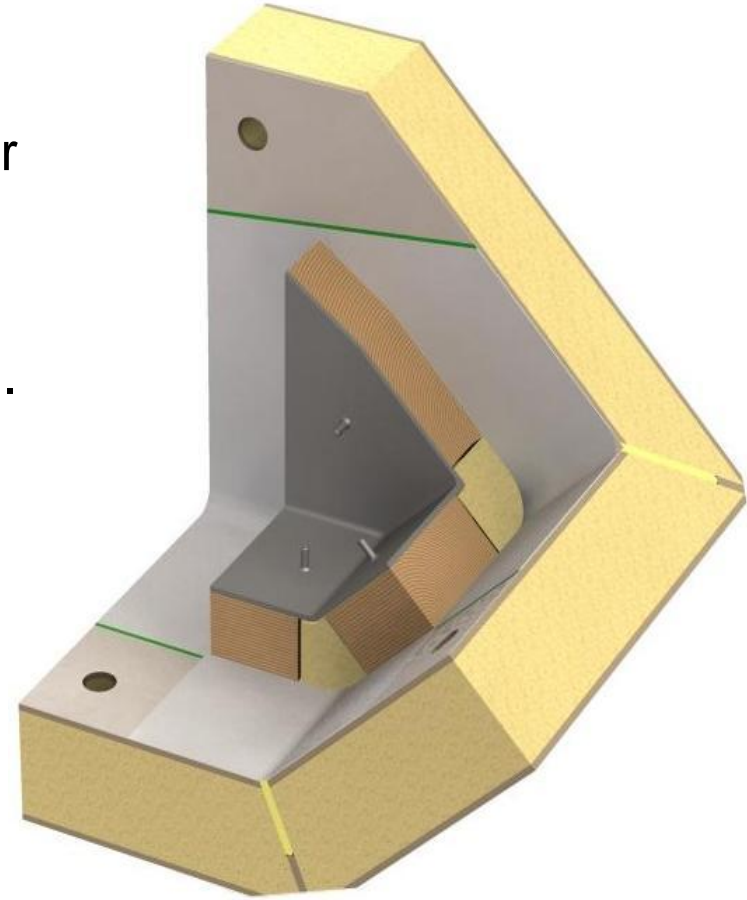

Typical trihedron

# System description – the trihedron

## ► Exploded view of a trihedron

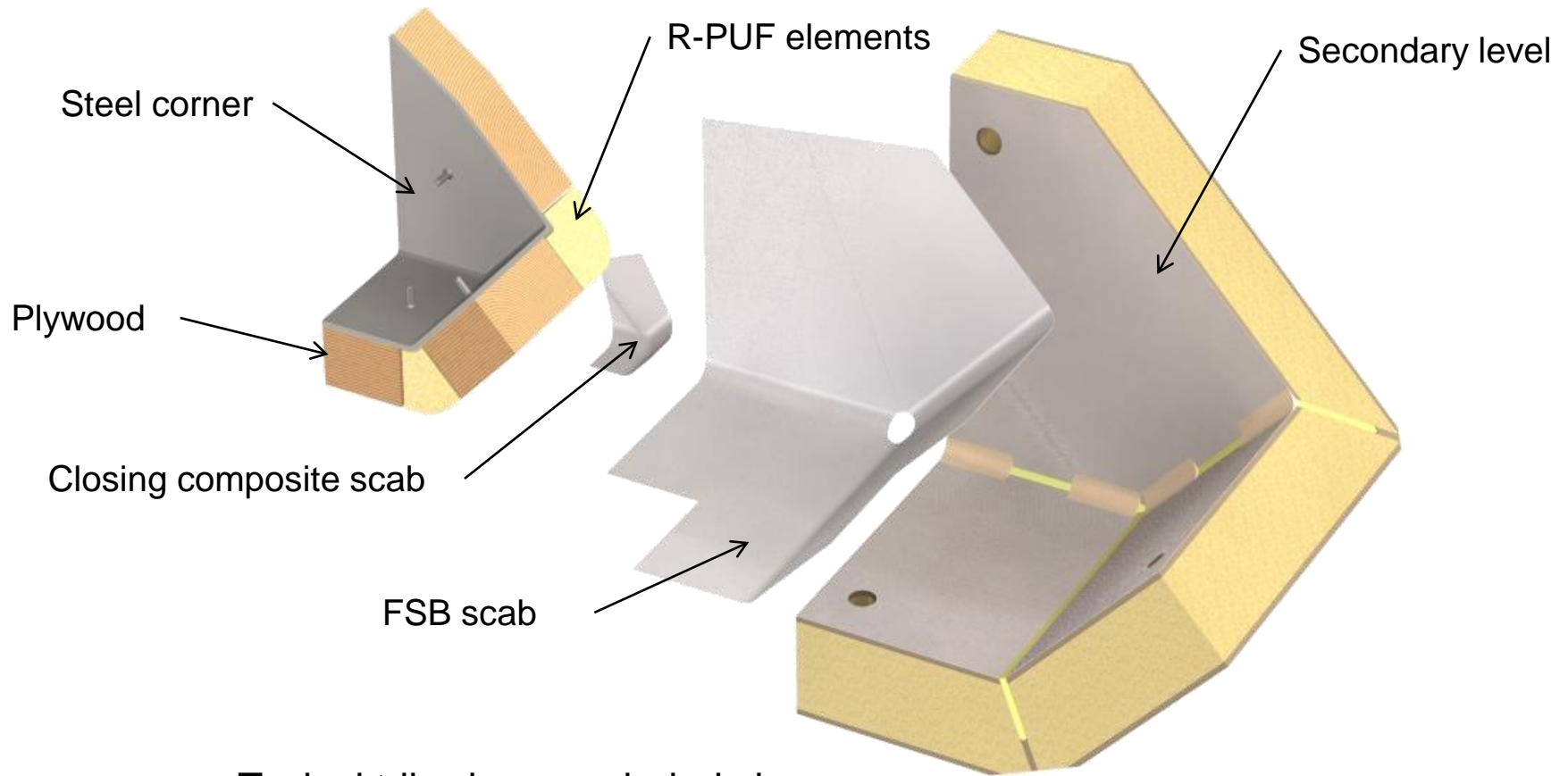

Typical trihedron, exploded view

# System description – the trihedron

## ► The trihedron: three-way panel in its context

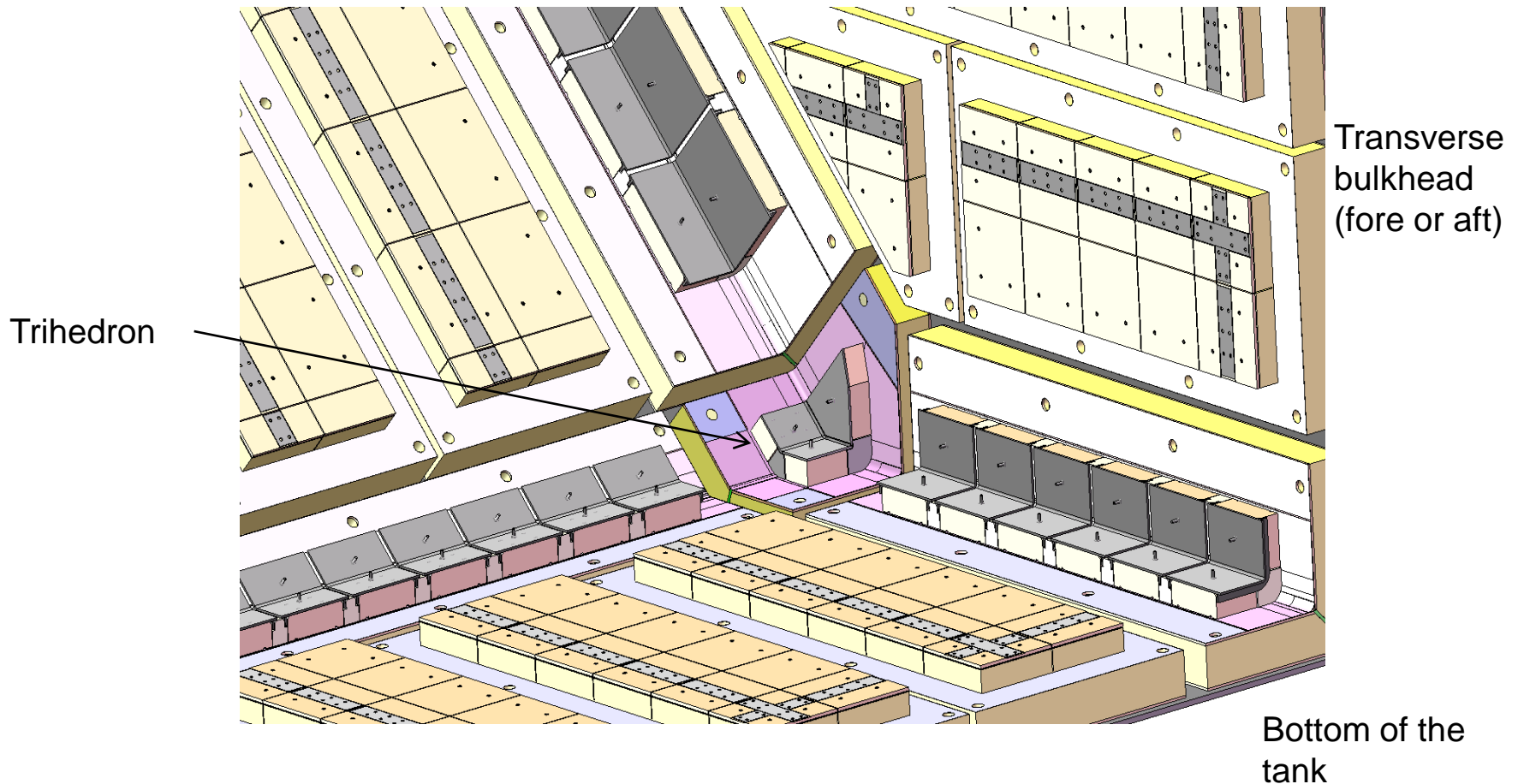

# AGENDA

- ▶ Mark III design concept

- ▶ **System description**

  - The flat wall area

  - The dihedron

  - The trihedron

  - Completion of the insulation**

  - The primary barrier

- ▶ Combined dome

- ▶ Mark III Flex

# System description – completion of insulation

## ▶ Secondary barrier completion

- ▶ The secondary barrier is closed by bonding FSB between panels

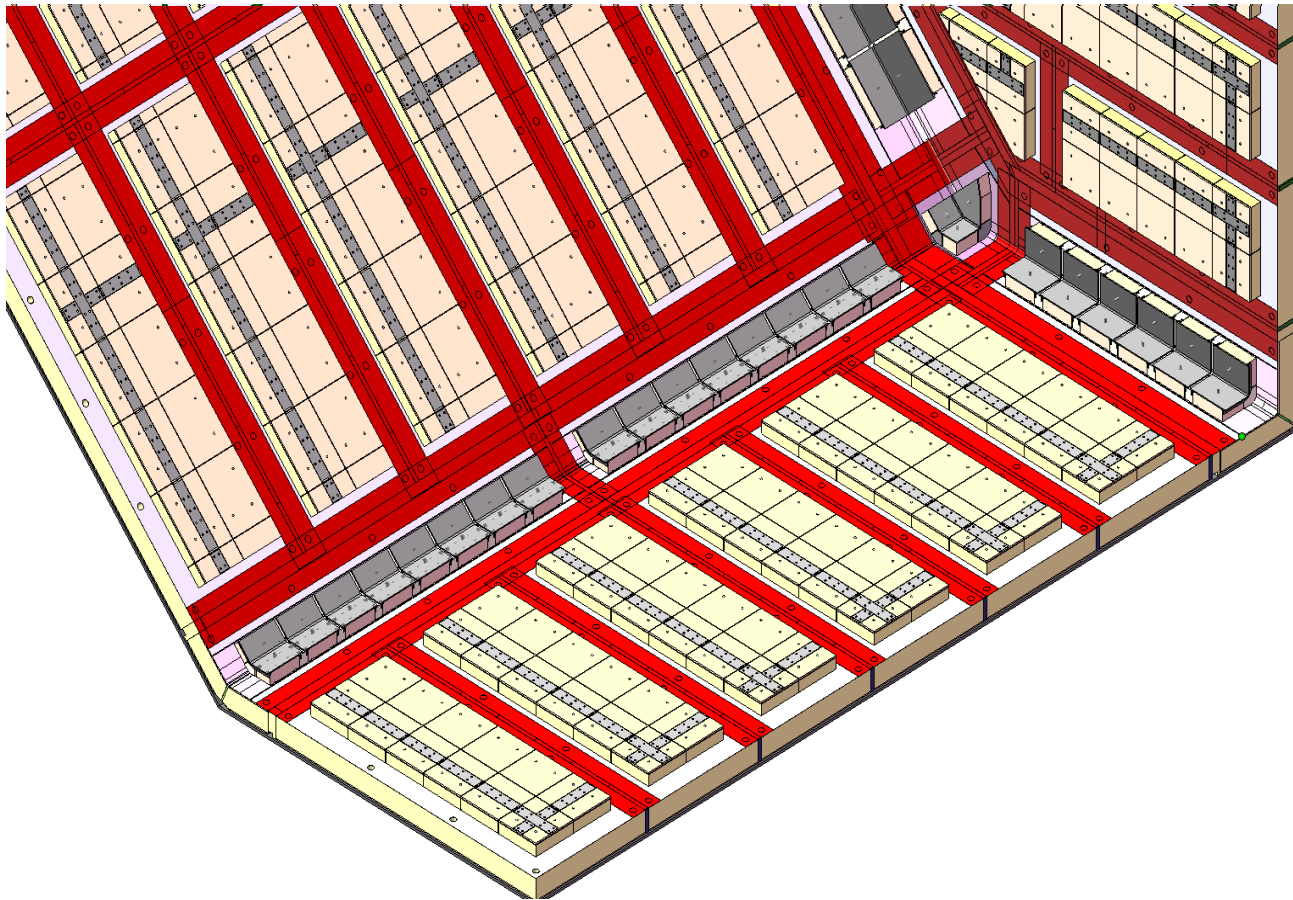

# System description – completion of insulation

- ▶ The top bridge pad has the same structure as the primary level of a flat panel:

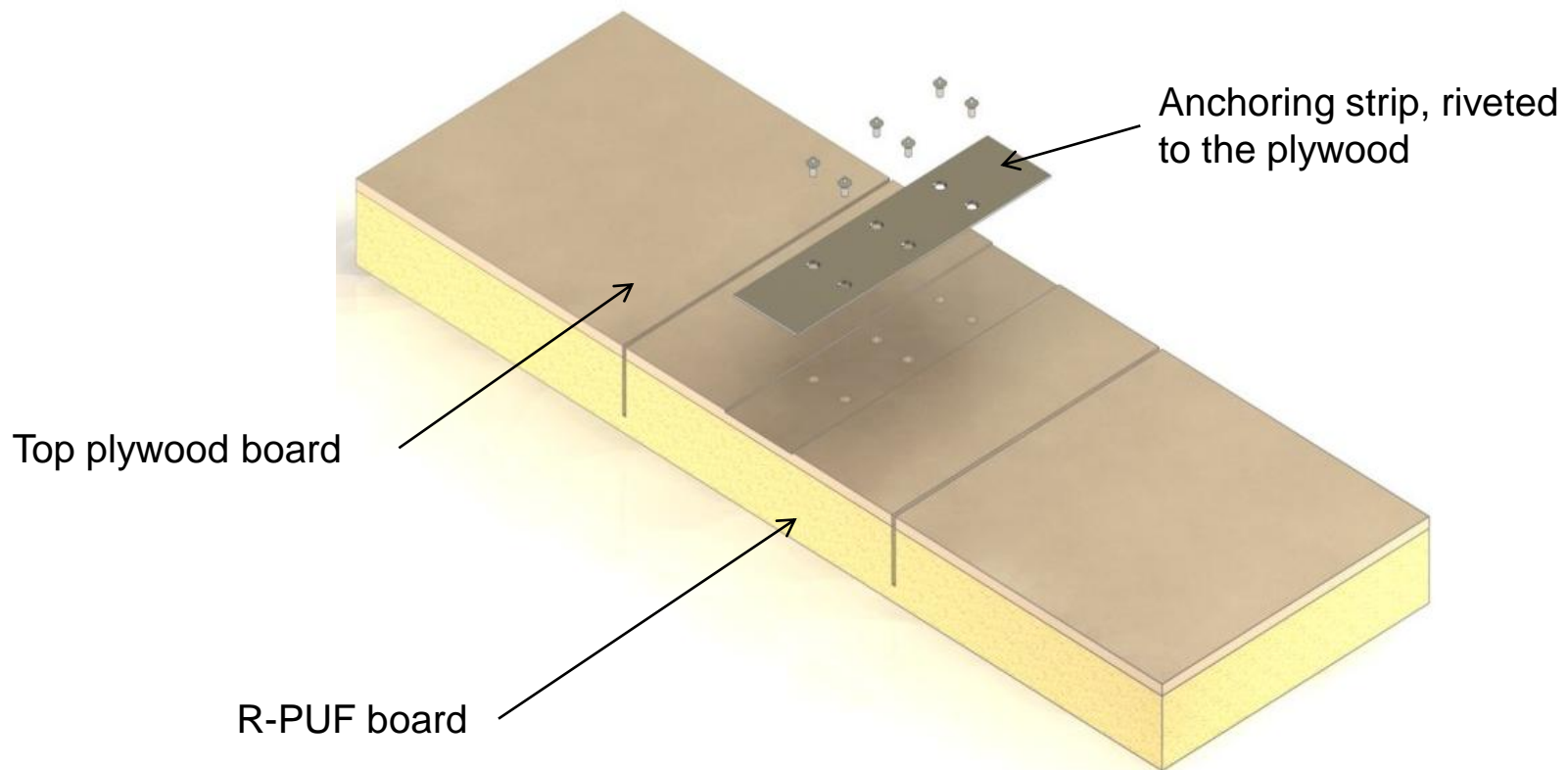

# System description – completion of insulation

- ▶ The erection-on-board has the same structure as the primary level of a corner panel:

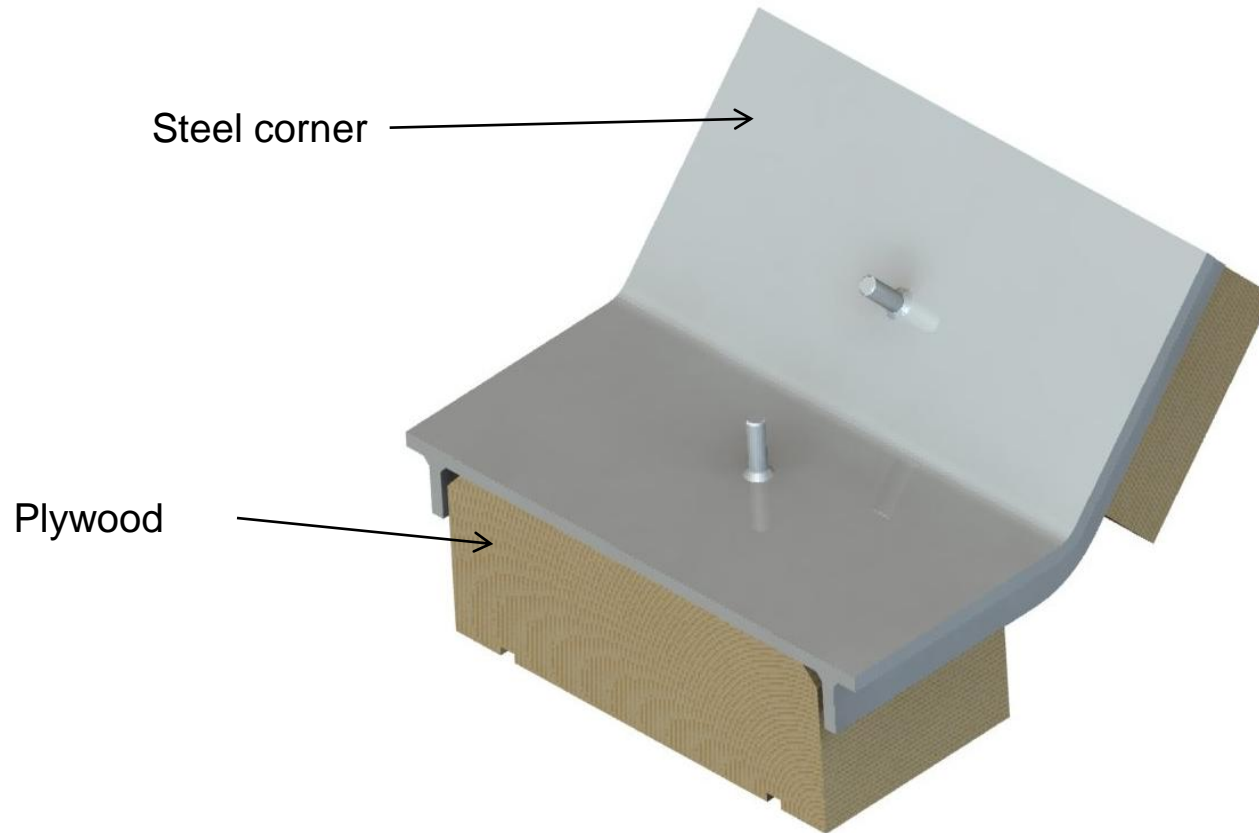



# System description – completion of insulation

- ▶ The primary insulation is completed by bonding "top bridge pads" and "erection-on-board"

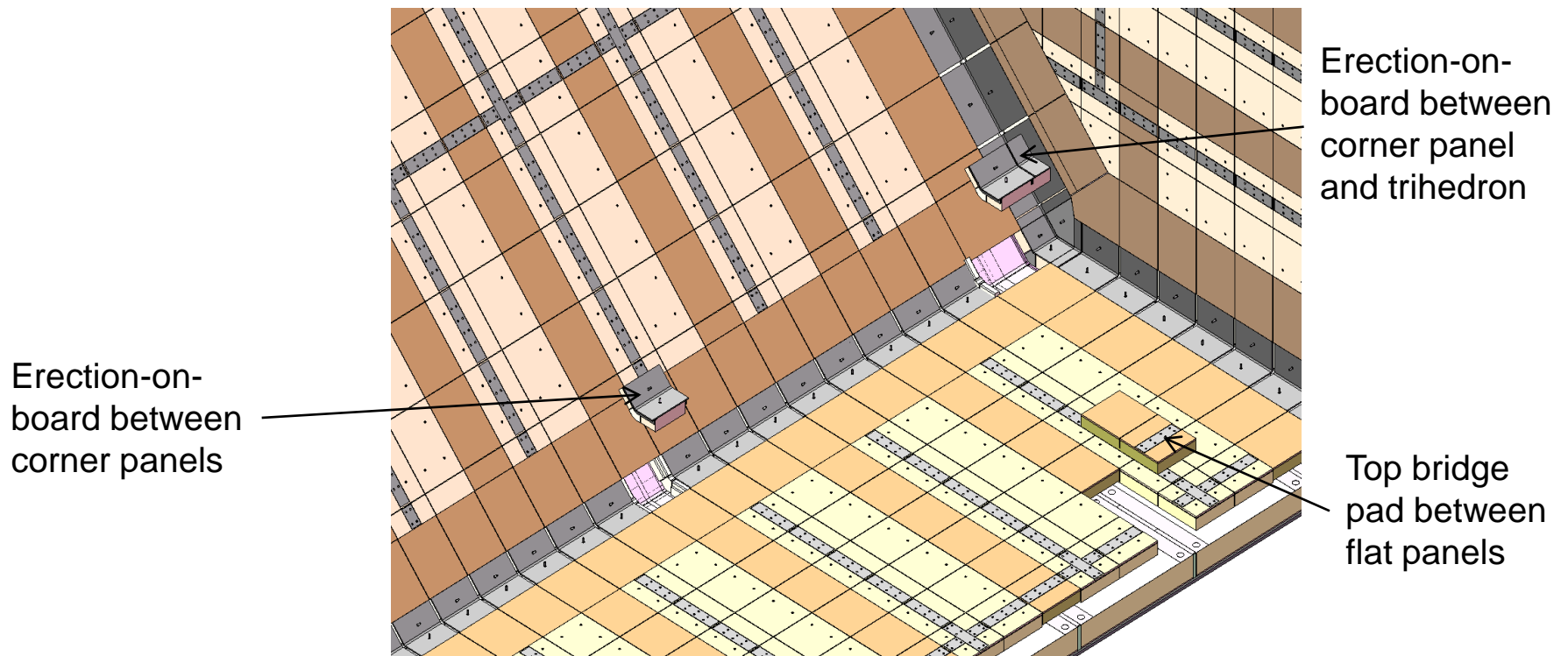

# System description – completion of insulation

- ▶ **Completed primary level**
  - ▶ insulation installation is completed

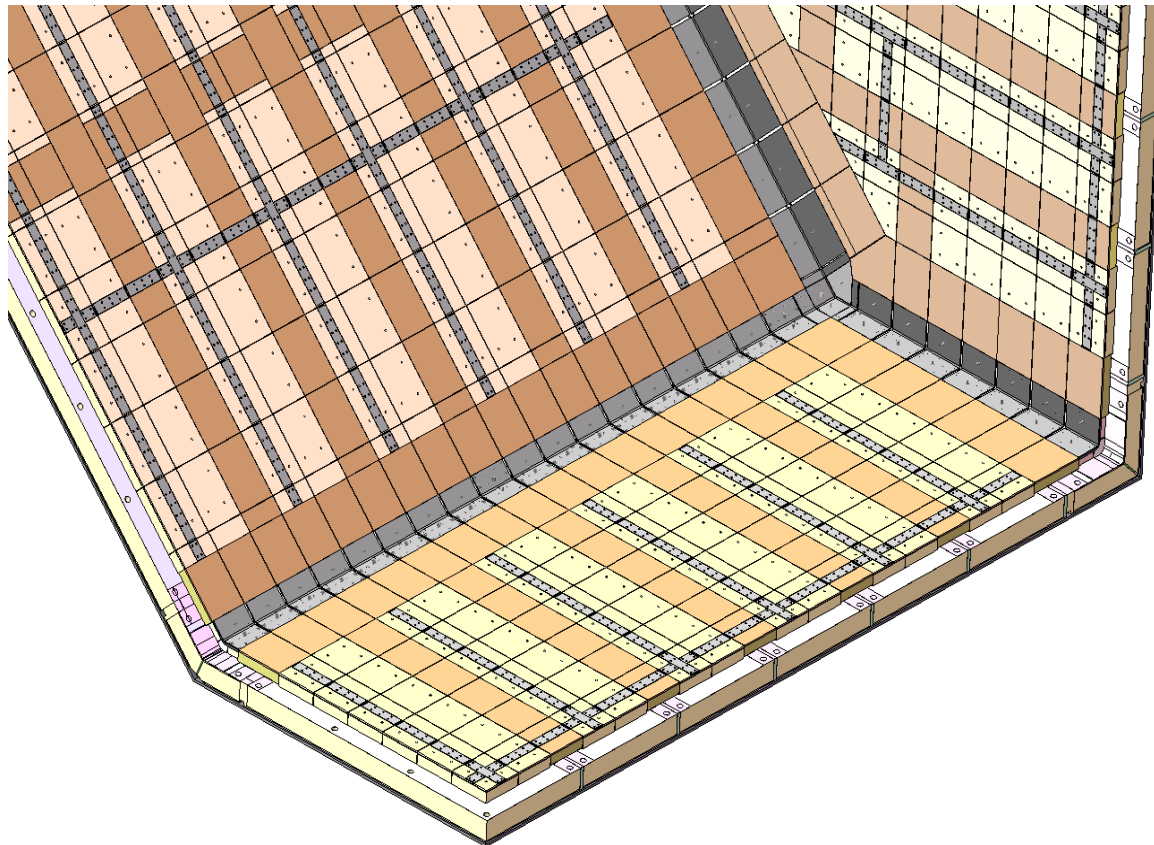

# AGENDA

- ▶ Mark III design concept
- ▶ **System description**
  - The flat wall area
  - The dihedron
  - The trihedron
  - Completion of the insulation
  - The primary barrier**
- ▶ Combined dome
- ▶ Mark III Flex

# System description – primary barrier

- ▶ Small (SC) and large (LC) corrugation arrangement

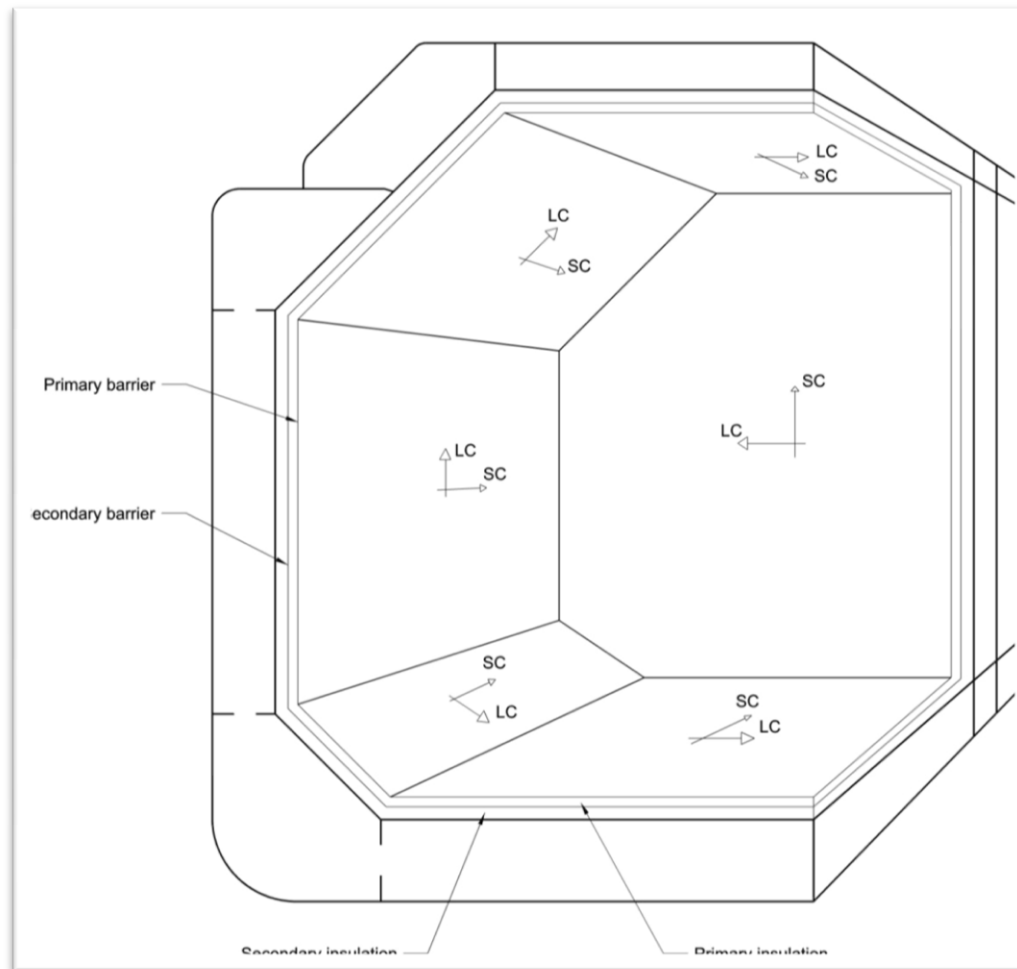

# System description – primary barrier

## ▶ Other small components of the primary barrier:

- ▶ To connect corrugations
- ▶ To end a corrugation
- ▶ To deviate a corrugation



Angle piece (small corrugation)

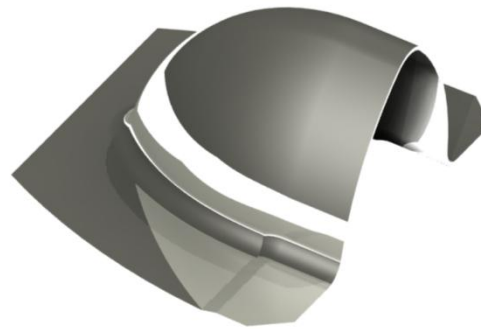

End cap (large corrugation)

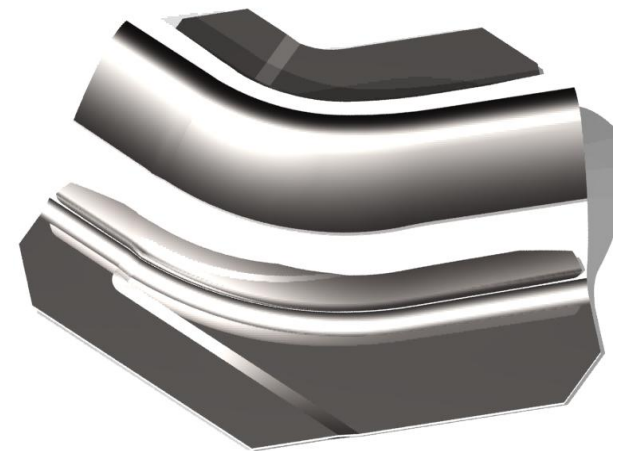

Deviation cap (large corrugation)

# System description – primary barrier

- ▶ Membrane sheets are welded on anchoring strips
- ▶ The membrane sheets overlap one another

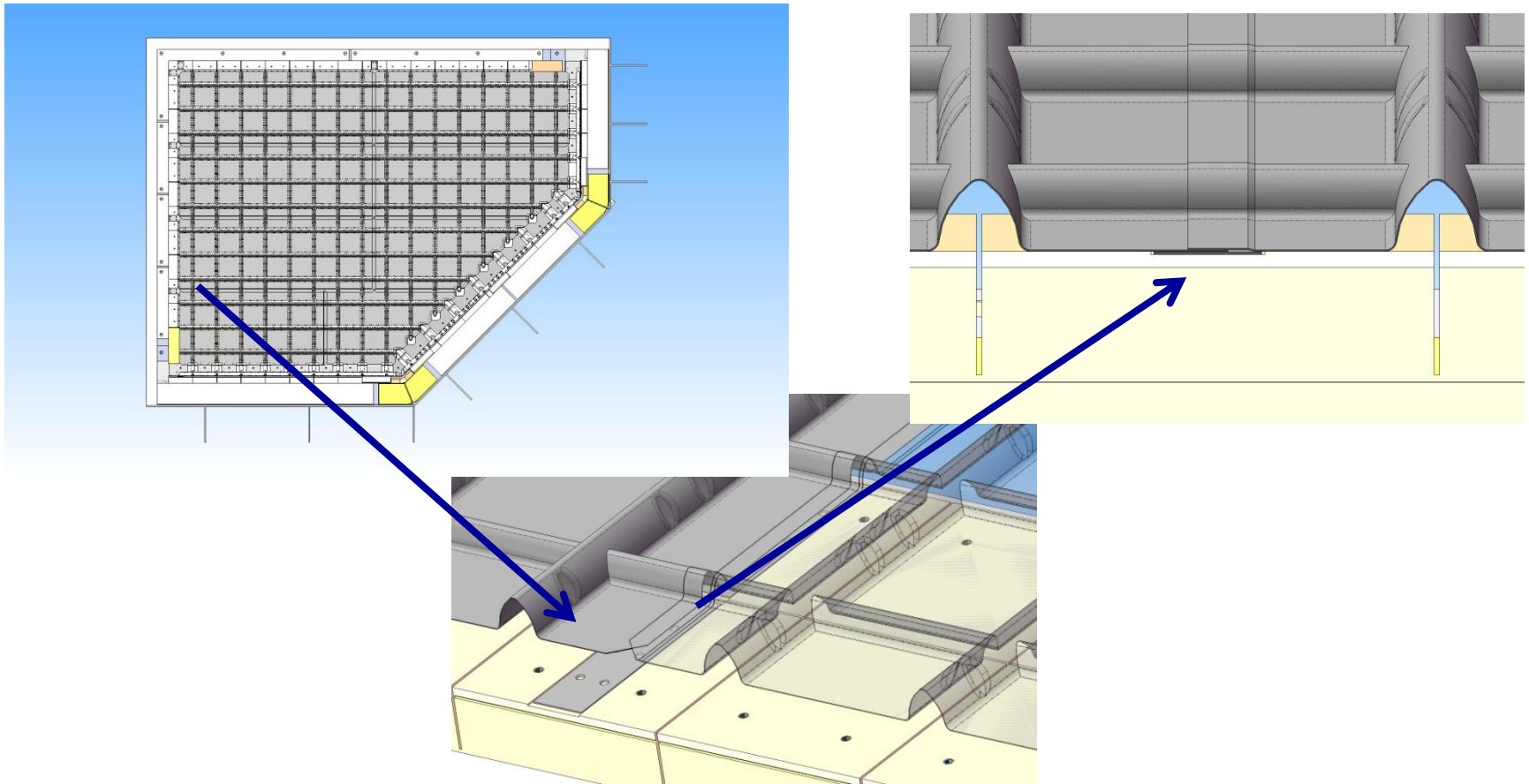

# AGENDA

- ▶ Mark III design concept
- ▶ System description
- ▶ **Combined dome**
- ▶ Mark III Flex

## Combined dome

- ▶ The combined dome is the area where the pump tower crosses the decks.
- ▶ All liquid and gaseous crossings are gathered at aft part of the tank

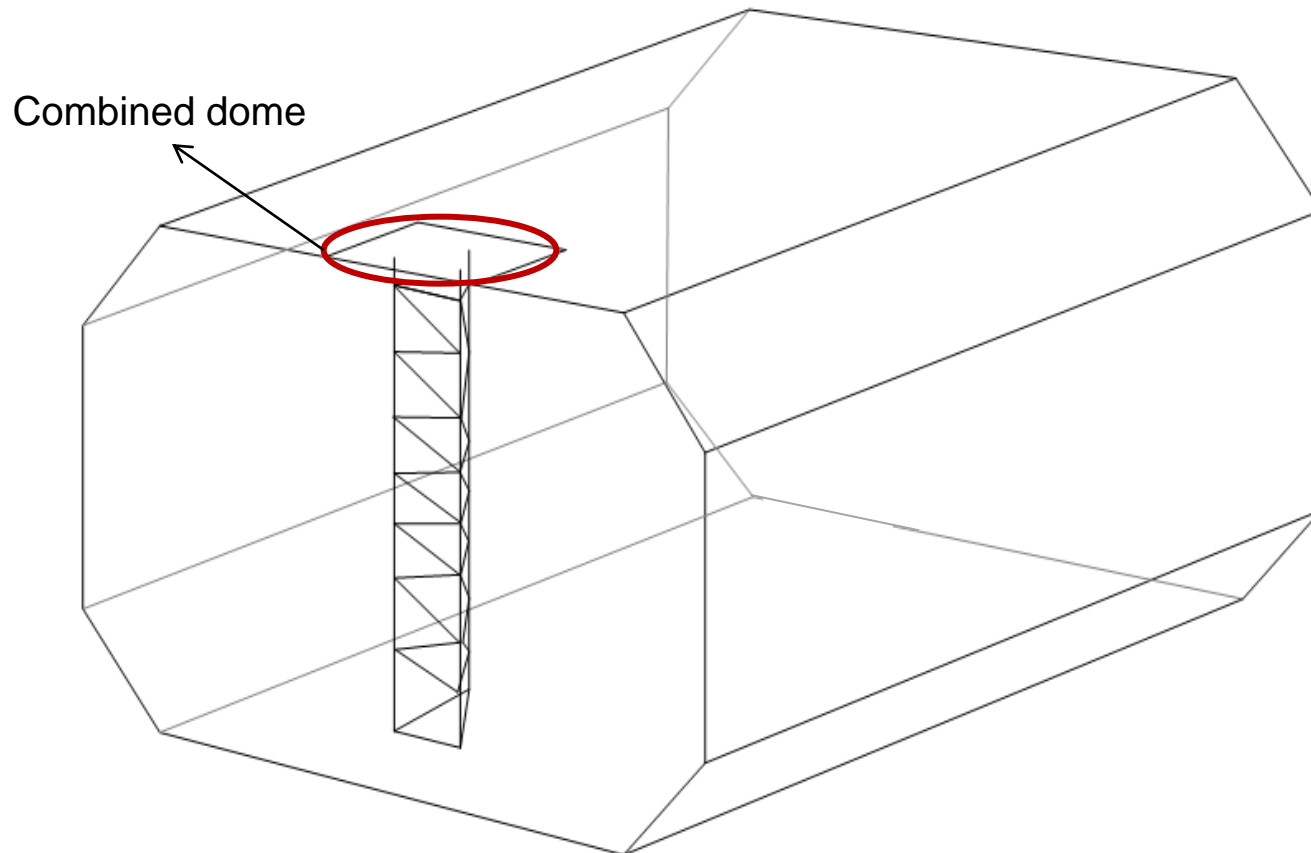



# Combined dome

- ▶ The combined dome is integrated to the ship structure

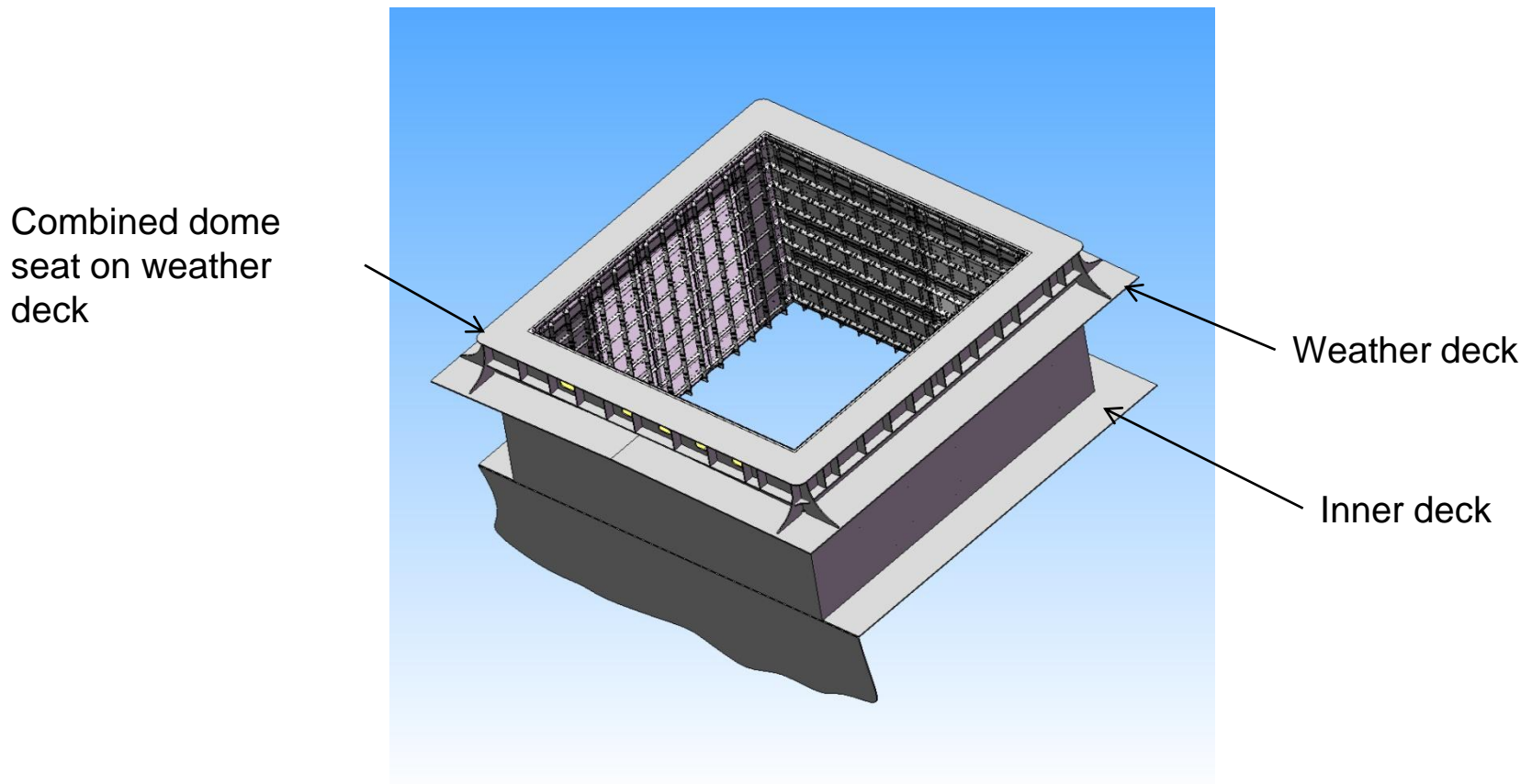

# Combined dome

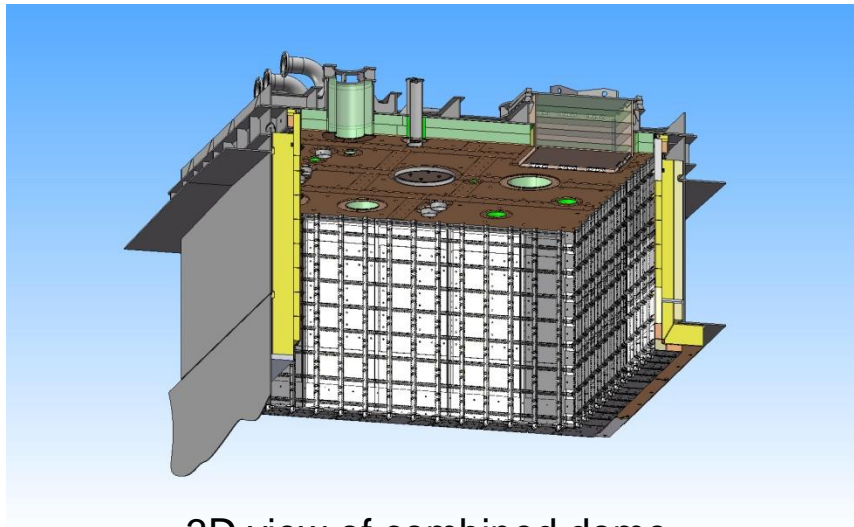

3D view of combined dome

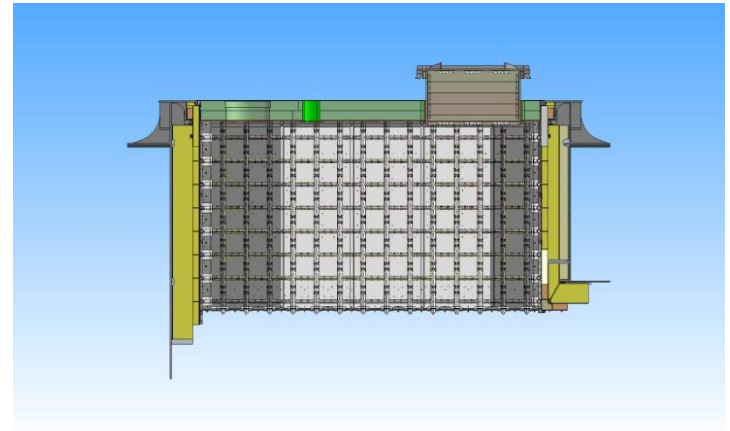

Side view of membrane arrangement

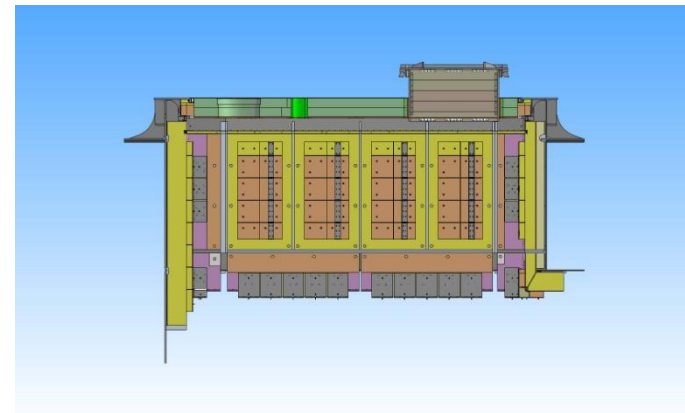

Side view of insulation panels arrangement

# AGENDA

- ▶ Mark III design concept
- ▶ System description
- ▶ Combined dome
- ▶ **Mark III Flex**

# Mark III Flex

- ▶ Increase of thickness
- ▶ BoR reduction

MARK III  
270mm

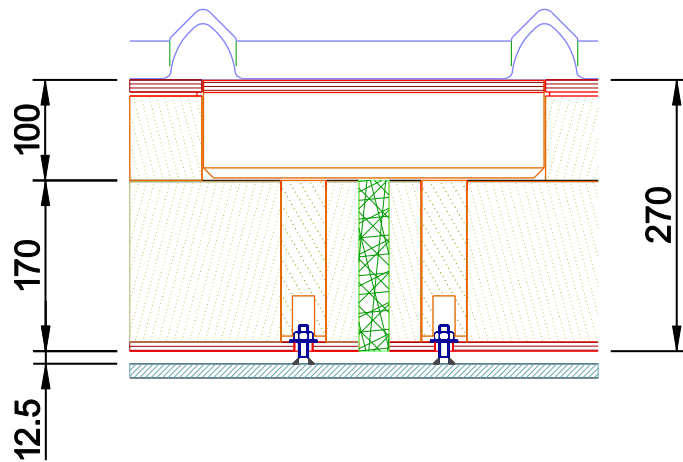

MARK III FLEX  
400 mm

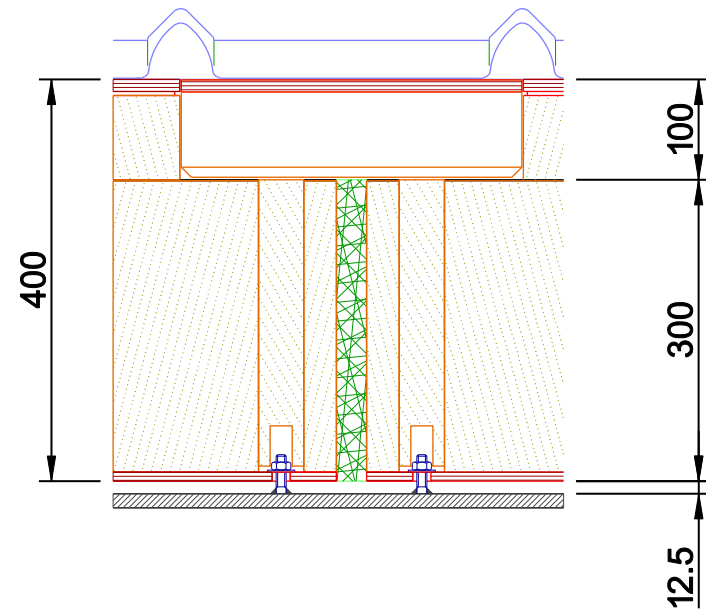

# Thank you for your attention.

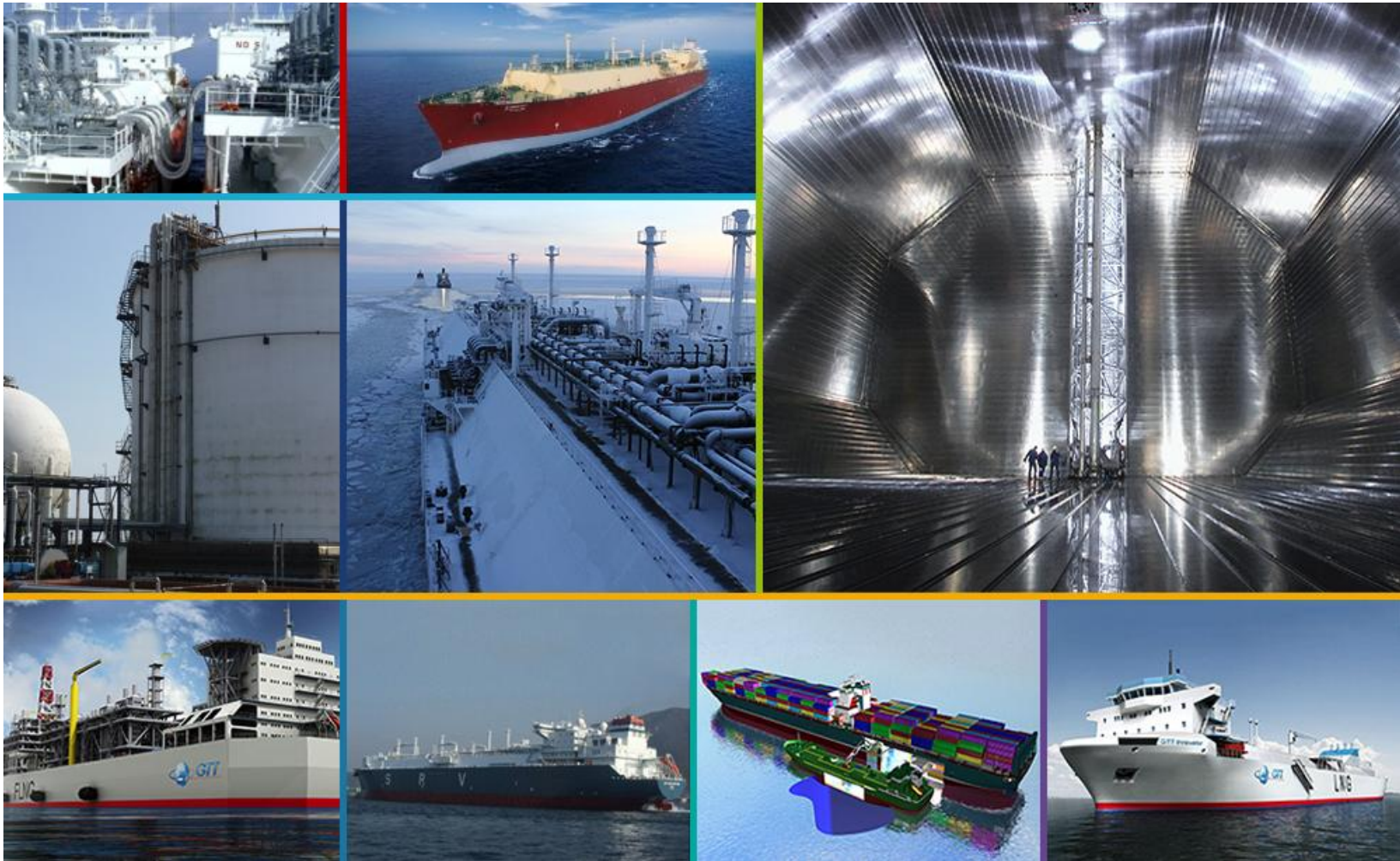



# Bunker ship 1860 m<sup>3</sup> for ARGOS

## CONTAINMENT SYSTEM DESIGN STUDIES

### SECTION 1 : CARGO TANKS

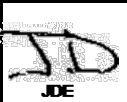
#### Section 1.1 : CARGO TANK BASIC DESIGN DATA

01			First Issue	28/11/2014			
REVISION	LABEL	ECR NBR	DESCRIPTION	DATE DD/MM/YYYY	BY	CHECKED	APPROVED

#### TECHNICAL DIVISION

Bunker ship 1860 m3 for ARGOS

MARK III SYSTEM

CARGO TANK BASIC DESIGN DATA

AP542b TANK ANA 1.1.0



1, route de Versailles  
78470 St-Rémy-lès-Chevreuse - FRANCE

PAGE: 1 NBR OF PAGES: 144

SCALE: None SHEET SIZE: A4

This document contains information resulting from testing, experience and know-how of GTT, which are protected under the legal regime of undisclosed information and trade secret (notably TRIPS Art. 39) and under Copyright law. This document is strictly confidential and the exclusive property of GTT. It cannot be copied, used, modified, adapted, disseminated, published or communicated, in whole or in part, by any means, for any purpose, without express prior written authorization of GTT. Any violation of this clause may give rise to civil or criminal liability - © GTT, 2010-2014



Bunker ship 1860 m<sup>3</sup> for ARGOS

**CARGO TANK BASIC DESIGN DATA**

**CONTAINMENT SYSTEM DESIGN STUDIES**

**AP542b TANK ANA 1.1.0**

Revision : 01

**28/11/2014**

**Page : 2 / 14**

## REVISION SHEET

REV.	Page Nbr																																																	
	01	02	03	04	05	06	07	08	09	10	11	12	13	14	15	16	17	18	19	20	21	22	23	24	25	26	27	28	29	30	31	32	33	34	35	36	37	38	39	40	41	42	43	44	45					
01	X	X	X	X	X	X	X	X	X	X	X	X	X	X																																				
-																																																		
Sheets affected by the current revision																																																		



Bunker ship 1860 m<sup>3</sup> for ARGOS

**CARGO TANK BASIC DESIGN DATA**

**CONTAINMENT SYSTEM DESIGN STUDIES**

**AP542b TANK ANA 1.1.0**

Revision : 01

28/11/2014

Page : 3 / 14

## CONTENTS

<b>1. INTRODUCTION</b>	<b>4</b>
<b>2. LNG TANKS CHARACTERISTICS</b>	<b>4</b>
2.1. DIMENSIONS	4
2.2. SURFACE AREAS	6
2.3. SOUNDING TABLES	7
<b>3. TEMPERATURE CHARTS</b>	<b>8</b>
3.1. ASSUMPTIONS	8
3.2. CALCULATION METHOD	9
3.3. RESULTS	9
3.3.1. TEMPERATURES OF COFFERDAM COMPARTMENTS	9
3.3.1. TEMPERATURES OF DOUBLE HULL COMPARTMENTS	10
3.3.2. STEEL GRADE SELECTION	11
<b>4. DESIGN BOIL-OFF RATE</b>	<b>12</b>
4.1. ASSUMPTIONS	12
4.2. CALCULATION METHOD	12
4.3. RESULTS	13
<b>5. HEAT CAPACITY ANALYSIS</b>	<b>13</b>
5.1. ASSUMPTIONS	13
5.2. CALCULATION METHOD	14
5.3. RESULTS	14





Bunker ship 1860 m<sup>3</sup> for ARGOS

**CARGO TANK BASIC DESIGN DATA**

**CONTAINMENT SYSTEM DESIGN STUDIES**

**AP542b TANK ANA 1.1.0**

Revision : 01

28/11/2014

Page : 4 / 14

## 1. INTRODUCTION

This analysis deals with the basic design data of the AP542b – bunker ship of 1 860 m<sup>3</sup> capacity for ARGOS. It includes:

- Tanks characteristics (dimensions, surfaces and sounding tables),
- Temperature charts and the associated steel grade selection,
- Design Boil-Off Rate (BOR) determination,
- Heat capacity analysis.

This study is based on the following documents provided by ARGOS:

- GENERAL ARRANGEMENT (GTT TANKS) dated 12/12/2013;
- MIDSHIP SECTIONS (GTT TANKS AREA) FR.57-145 dated 12/03/2014;
- MIDSHIP SECTIONS (LONGITUDINAL) FR.57-145 dated 12/03/2014.

## 2. LNG TANKS CHARACTERISTICS

### 2.1. DIMENSIONS

The set of dimensions detailed hereafter refers to the following figure:

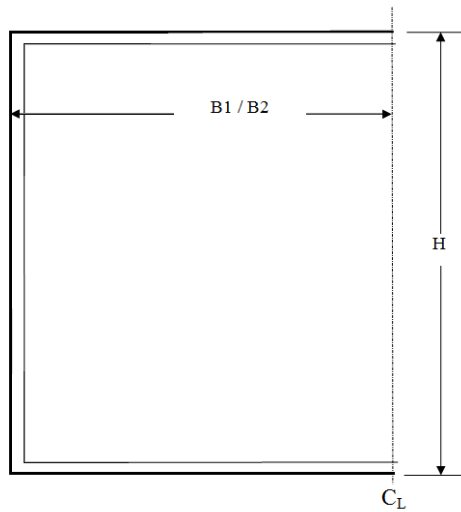

Average thickness of inner hull:	0.0175 m
Average thickness of bearing mastic:	0.0125 m
Total insulation thickness:	0.4000 m
Thickness of secondary insulation:	0.3000 m
Thickness of primary insulation:	0.1000 m



Bunker ship 1860 m<sup>3</sup> for ARGOS

**CARGO TANK BASIC DESIGN DATA**

**CONTAINMENT SYSTEM DESIGN STUDIES**

**AP542b TANK ANA 1.1.0**

Revision : 01

28/11/2014

Page : 5 / 14

**Dimensions on Inner Hull steel plating - inside (in meters) :**

	L	H	B1	B2
Tank n°1	22.585	4.905	5.683	5.683
Tank n°2	22.585	4.905	5.683	5.683

**Dimensions on secondary barrier (in meters) :**

	L	H	B1	B2
Tank n°1	21.960	4.280	5.370	5.370
Tank n°2	21.960	4.280	5.370	5.370

**Dimensions on primary barrier (in meters) :**

	L	H	B1	B2
Tank n°1	21.760	4.080	5.270	5.270
Tank n°2	21.760	4.080	5.270	5.270



Bunker ship 1860 m<sup>3</sup> for ARGOS

**CARGO TANK BASIC DESIGN DATA**

**CONTAINMENT SYSTEM DESIGN STUDIES**

**AP542b TANK ANA 1.1.0**

Revision : 01

**28/11/2014**

**Page : 6 / 14**

## 2.2. SURFACE AREAS

### Primary membrane level

	Tank 1 (m <sup>2</sup> )	Tank 2 (m <sup>2</sup> )	TOTAL (m <sup>2</sup> )
Ceiling area	229.4	229.4	458.7
Longitudinal walls	177.6	177.6	355.1
Bottom area	229.4	229.4	458.7
Transverse bulkhead fore	43.0	43.0	86.0
Transverse bulkhead aft	43.0	43.0	86.0
<b>Total</b>	<b>722.3</b>	<b>722.3</b>	<b>1444.5</b>

### Secondary membrane level

	Tank 1 (m <sup>2</sup> )	Tank 2 (m <sup>2</sup> )	TOTAL (m <sup>2</sup> )
Ceiling area	235.9	235.9	471.7
Longitudinal walls	188.0	188.0	376.0
Bottom area	235.9	235.9	471.7
Transverse bulkhead fore	46.0	46.0	91.9
Transverse bulkhead aft	46.0	46.0	91.9
<b>Total</b>	<b>751.6</b>	<b>751.6</b>	<b>1503.2</b>

### Inner hull level (inside)

	Tank 1 (m <sup>2</sup> )	Tank 2 (m <sup>2</sup> )	TOTAL (m <sup>2</sup> )
Ceiling area	256.7	256.7	513.4
Longitudinal walls	221.6	221.6	443.1
Bottom area	256.7	256.7	513.4
Transverse bulkhead fore	55.7	55.7	111.5
Transverse bulkhead aft	55.7	55.7	111.5
<b>Total</b>	<b>846.4</b>	<b>846.4</b>	<b>1692.8</b>



Bunker ship 1860 m<sup>3</sup> for ARGOS

**CARGO TANK BASIC DESIGN DATA**

**CONTAINMENT SYSTEM DESIGN STUDIES**

**AP542b TANK ANA 1.1.0**

Revision : 01

28/11/2014

Page : 7 / 14

**2.3. SOUNDING TABLES**

**Sounding of Tank n°1 & 2**

Filling (m)	%H	Wet. Surf. (m <sup>2</sup> )	Volume (m <sup>3</sup> )	%V
0.000	0.0	0.00	0.0	0.0
0.102	2.5	235.94	21.0	2.3
0.204	5.0	242.53	44.4	4.8
0.306	7.5	249.12	67.7	7.3
0.408	10.0	255.71	91.0	9.8
0.510	12.5	262.30	114.3	12.3
0.612	15.0	268.89	137.7	14.8
0.714	17.5	275.47	161.0	17.3
0.816	20.0	282.06	184.3	19.9
0.918	22.5	288.65	207.7	22.4
1.020	25.0	295.24	231.0	24.9
1.122	27.5	301.83	254.3	27.4
1.224	30.0	308.42	277.6	29.9
1.326	32.5	315.01	301.0	32.4
1.428	35.0	321.60	324.3	34.9
1.530	37.5	328.19	347.6	37.4
1.632	40.0	334.78	371.0	40.0
1.734	42.5	341.37	394.3	42.5
1.836	45.0	347.96	417.6	45.0
1.938	47.5	354.55	440.9	47.5
2.040	50.0	361.13	464.3	50.0
2.142	52.5	367.72	487.6	52.5
2.244	55.0	374.31	510.9	55.0
2.346	57.5	380.90	534.2	57.5
2.448	60.0	387.49	557.6	60.0
2.550	62.5	394.08	580.9	62.6
2.652	65.0	400.67	604.2	65.1
2.754	67.5	407.26	627.6	67.6
2.856	70.0	413.85	650.9	70.1
2.958	72.5	420.44	674.2	72.6
3.060	75.0	427.03	697.5	75.1
3.162	77.5	433.62	720.9	77.6
3.264	80.0	440.20	744.2	80.1
3.366	82.5	446.79	767.5	82.7
3.468	85.0	453.38	790.9	85.2
3.570	87.5	459.97	814.2	87.7
3.672	90.0	466.56	837.5	90.2
3.774	92.5	473.15	860.8	92.7
3.876	95.0	479.74	884.2	95.2
3.978	97.5	486.33	907.5	97.7
4.080	100.0	722.27	928.5	100.0



Bunker ship 1860 m<sup>3</sup> for ARGOS

CARGO TANK BASIC DESIGN DATA

CONTAINMENT SYSTEM DESIGN STUDIES

AP542b TANK ANA 1.1.0

Revision : 01

28/11/2014

Page : 8 / 14

## 3. TEMPERATURE CHARTS

### 3.1. ASSUMPTIONS

Environmental conditions have been considered as follows in accordance with IGC Code:

- Air temperature: 5°C
- Sea water temperature: 0°C
- No Wind
- LNG in contact with the secondary barrier ( $T_{LNG} = -163^{\circ}\text{C}$ ).

The temperature of the Fuel Oil Cargo Tank 1 and 2 is assumed equal to:

- $T_{FOCT}$ : 5°C

The draft of the ship has been taken equal to 4.5 m (Scantling Draft).

The insulation thermal conductivity curves, used for the calculations are based on homologation batches of R.PUF expanded with the help of CO<sub>2</sub>.

These measurements were made in GTT laboratory (ST REMY LES CHEVREUSE, FRANCE) in 2013 (cf. Figure below). These curves should be subject to adjustments according to the results of future productions.

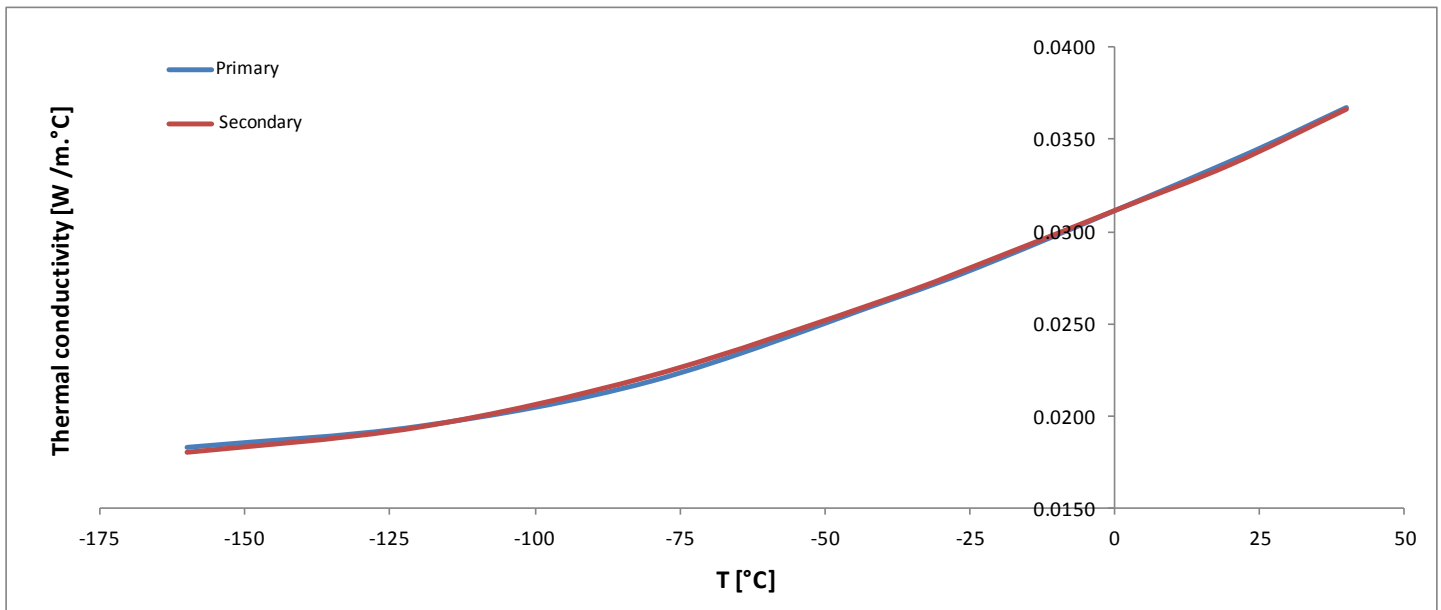



Bunker ship 1860 m<sup>3</sup> for ARGOS

**CARGO TANK BASIC DESIGN DATA**

**CONTAINMENT SYSTEM DESIGN STUDIES**

**AP542b TANK ANA 1.1.0**

Revision : 01

**28/11/2014**

**Page : 9 / 14**

### 3.2. CALCULATION METHOD

For each of the adjacent compartments of the double hull, the heat transfer rate is calculated through each of the elementary exchange area.

By applying the equilibrium equation to each of these compartments, the temperature inside the compartment can be calculated.

Temperature of double hull is then estimated, considering only the two heat transfer modes (conduction and convection).

Based on the above temperatures, and the table 6.5 of the IGC Code, it is then possible to select the appropriate steel grade for the contiguous hull.

### 3.3. RESULTS

#### 3.3.1. TEMPERATURES OF COFFERDAM COMPARTMENTS

	Cofferdam 1		Cofferdam 2		Cofferdam 3	
	Temp. inside compartment	Temp. of inner hull	Temp. inside compartment	Temp. of inner hull	Temp. inside compartment	Temp. of inner hull
IGC Conditions	0.4°C	-1.6°C	-6.3°C	-8.2°C	0.1°C	-1.9°C



Bunker ship 1860 m<sup>3</sup> for ARGOS

**CARGO TANK BASIC DESIGN DATA**

**CONTAINMENT SYSTEM DESIGN STUDIES**

**AP542b TANK ANA 1.1.0**

Revision : 01

28/11/2014

Page : 10 / 14

**3.3.1. TEMPERATURES OF DOUBLE HULL COMPARTMENTS**

**IGC CONDITIONS**

External air temperature 5 °C  
 Wind 0  
 Water temperature 0 °C  
 LNG on Secondary barrier

Insulation thickness		
Secondary	0.3000	m
Primary	0.1000	m

LNG Cargo Temperature  
 -163.0 °C

-1.4	Air temperature inside compartment (°C)
-2.5	Inner Hull Steel Plating (°C)
-0.1	Outer Hull Steel Plating (°C)

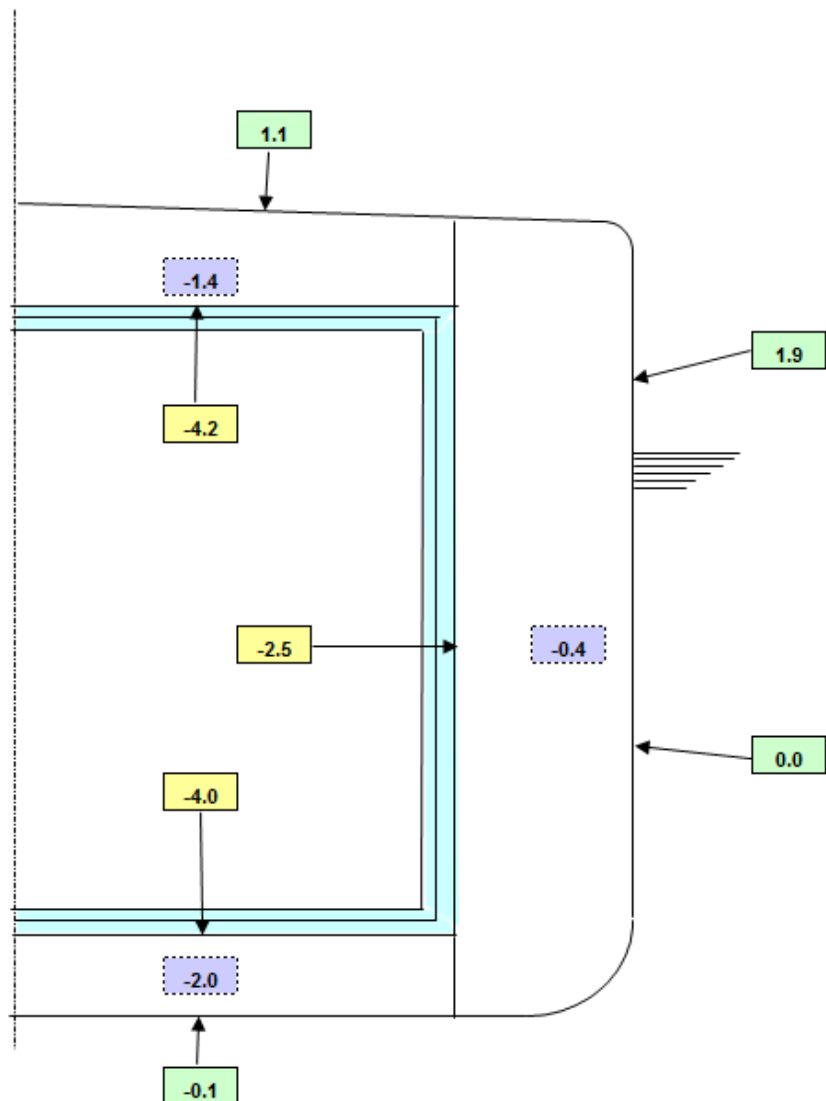



Bunker ship 1860 m<sup>3</sup> for ARGOS

CARGO TANK BASIC DESIGN DATA

CONTAINMENT SYSTEM DESIGN STUDIES

AP542b TANK ANA 1.1.0

Revision : 01

28/11/2014

Page : 11 / 14

### 3.3.2. STEEL GRADE SELECTION

Results are summed up on the figure below. They are based on the table 6.5 of IGC Code and the calculated temperatures.

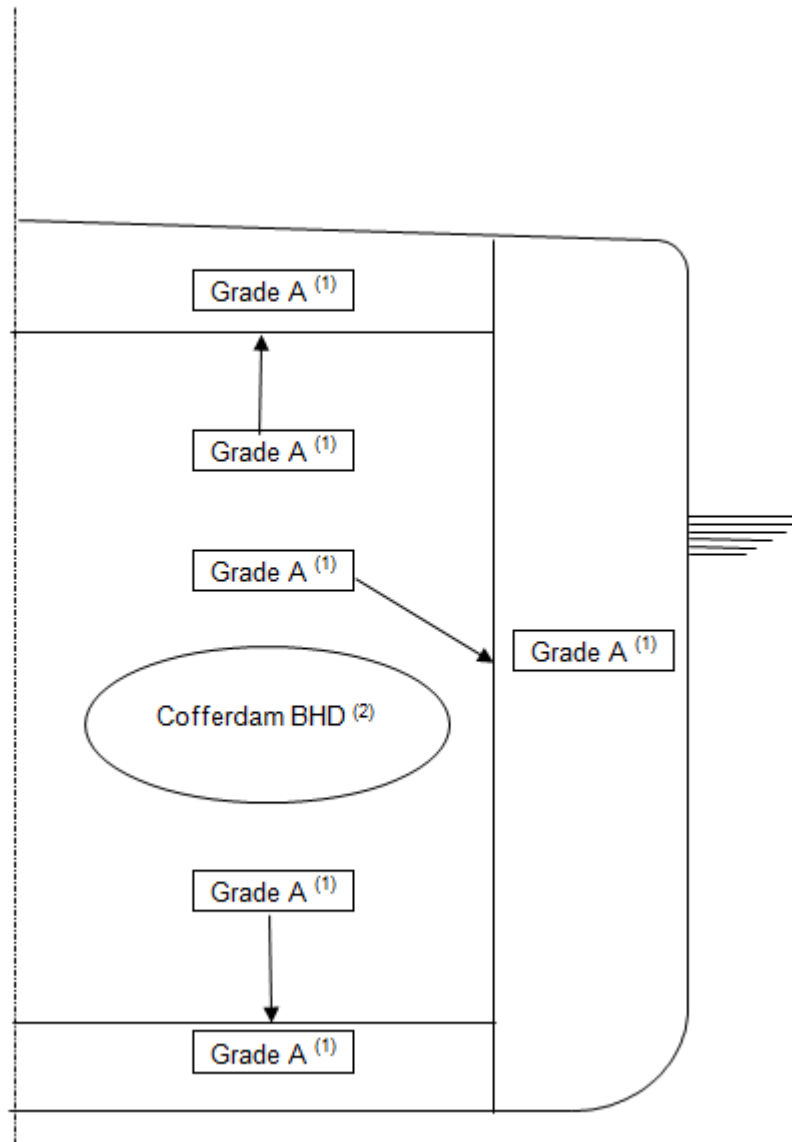

Longitudinals attached to inner hull: same grade as per attached plate.

Members connected to both inner and outer hulls shall be suitable with the mean linear temperature of inner and outer hulls.

- (1) Grade A for thickness up to 15mm, for higher thickness (up to 25mm) use of grade B necessary.
- (2) For Cofferdam 1 & 3: Grade A for thickness up to 15mm, for higher thickness (up to 25mm) use of grade B necessary.  
For Cofferdam 2: Grade B for thickness up to 20mm, for higher thickness (up to 25mm) use of grade D necessary.





Bunker ship 1860 m<sup>3</sup> for ARGOS

**CARGO TANK BASIC DESIGN DATA**

**CONTAINMENT SYSTEM DESIGN STUDIES**

**AP542b TANK ANA 1.1.0**

Revision : 01

28/11/2014

Page : 12 / 14

## 4. DESIGN BOIL-OFF RATE

### 4.1. ASSUMPTIONS

The following assumptions and conditions are considered for boil-off rate calculations. They are based on IMO conditions and special requirements of the specification.

- **LNG in contact with primary barrier**
- **Environmental conditions :**
  - Air Temperature : 45°C
  - Seawater Temperature : 32°C
- **LNG characteristics :**
  - Tanks filling ratio : 98.0 %
  - Composition: Pure methane CH<sub>4</sub>
  - Temperature : - 161.5 °C
  - Specific density : 425 kg/m<sup>3</sup>
  - Latent heat of vaporization : 511 kJ/kg

The temperature of the Fuel Oil Cargo Tank 1 and 2 is assumed equal to:

- T<sub>FOCT</sub>: 35°C

### 4.2. CALCULATION METHOD

This calculation method can be summarized as follows:

For each of the adjacent compartments of the double hull, the heat transfer rate is calculated through each of the elementary exchange area.

By applying the equilibrium equation to each of these compartments, the temperature inside the compartment can be calculated.

Temperature of double hull is then estimated, considering only the two heat transfer modes (conduction and convection).

Once the overall heat transfer rate  $\varphi$  is calculated, the boil-off rate is got from the following formula:

$$\text{B.O.R.} = \frac{\varphi}{d * V * L} * 3600 * 24$$

Where  $d$  and  $L$  represent respectively the density and vaporization latent heat of the methane;

$V$  is the cargo capacity (corresponding to 98% of the total capacity).



Bunker ship 1860 m<sup>3</sup> for ARGOS

**CARGO TANK BASIC DESIGN DATA**

**CONTAINMENT SYSTEM DESIGN STUDIES**

**AP542b TANK ANA 1.1.0**

Revision : 01

28/11/2014

Page : 13 / 14

### 4.3. RESULTS

The design boil-off rate predictions are given in the table below. Results show that there is a sufficient margin versus the design boil-off rate of 0.540% per day.

**R.PUF CARBON EXPANDED WITH CO2**

External Ambient Conditions : IGC Code		Insulation Data :		Methane and Operating Data :	
- Air Temperature =	45.0 °C	Mark III Flex :		Cargo temperature	-161.5 °C
- Water Temperature =	32.0 °C	Secondary Ins. Thickness =	0.300 m	Density =	425 kg/m <sup>3</sup>
- Aft cofferdam steel plating temperature =	30.9 °C	Primary Ins. Thickness =	0.100 m	Vaporiz. Latent Heat =	511 kJ/kg
- FWD cofferdam steel plating temperature =	30.9 °C	Total Ins. Thickness <sup>(1)</sup> =	0.400 m	Tank Filling Ratio =	98.0 %
- Central cofferdams steel plating temperature =	26.1 °C	<sup>(1)</sup> : Excluding mastic and hull			

	FLAT WALL AREA	TRANSVERSE CORNERS		CARGO TANK VOLUME (At 100%)	HEAT TRANSFER RATE With LNG at -161.5°C	TANK INDIVIDUAL B.O.R (At 98% tank capacity)
		Length	Area (Primary)			
TANK N° 1	596 m <sup>2</sup>	146 m	126 m <sup>2</sup>	929 m <sup>3</sup>	11426 W	0.500 % Day
TANK N° 2	596 m <sup>2</sup>	146 m	126 m <sup>2</sup>	929 m <sup>3</sup>	11426 W	0.500 % Day
OVERALL	1193 m <sup>2</sup>	291 m	252 m <sup>2</sup>	1857 m <sup>3</sup>	22852 W	0.500 % Day
<b>DESIGN DAILY BOIL-OFF RATE =</b>						<b>0.540 %</b>

## 5. HEAT CAPACITY ANALYSIS

### 5.1. ASSUMPTIONS

Calculations have been performed considering the following assumptions:

- LNG in contact with primary barrier (T<sub>LNG</sub> = -163°C)
- Tanks surface : 100 %

#### Environmental conditions:

- Air Temperature : 45°C
- Seawater Temperature : 32°C

Regarding the insulation characteristics, temperatures of the primary barrier and the double hull are assumed to be initially at 45°C or 32°C, depending on the location of the compartment from the waterline.

The final temperature at primary membrane level is the cargo temperature (-163°C).

Data used for heat capacity of materials and components are based on and adjusted according to different sources of information:

- Data available in various publications concerning classical materials;
- Experiments performed in GTT laboratory concerning specific insulating materials, components and assemblies.

Details of these heat capacity coefficients and their combination for each specific component are to be considered as proprietary information belonging to the specific GTT know-how. They are subject to constant checking and improvements according to insulation systems design progress.



Bunker ship 1860 m<sup>3</sup> for ARGOS

**CARGO TANK BASIC DESIGN DATA**

**CONTAINMENT SYSTEM DESIGN STUDIES**

**AP542b TANK ANA 1.1.0**

Revision : 01

28/11/2014

Page : 14 / 14

## 5.2. CALCULATION METHOD

Cargo tanks are first divided into elementary groups, such as dihedrals, standard panels...

For each type of group, the corresponding heat capacity is calculated, according to both geometrical and physical properties of this group.

Then, for each elementary surface  $S_i$ , the heat energy status is obtained, using the following relation:

$$Q_i = C_{p_i} S_i \Delta T_i / 2$$

Where  $\Delta T_i$  = difference between the temperature of the double hull, and the temperature of the cargo.

The total insulation heat capacity is the sum of all the  $Q_i$  for all the tanks:

$$Q = \sum_i Q_i = \sum_i C_{p_i} S_i \Delta T_i / 2$$

## 5.3. RESULTS

Results are summed up in the table hereafter.

External Ambient Conditions :	
- Air Temperature =	45 °C
- Seawater Temperature =	32 °C
- Insulation temperature above water line =	45 °C
- Insulation temperature under water line =	32 °C
- Cargo temperature =	-163 °C

Insulation Data :	
Secondary Ins. Thickness =	0.300 m
Primary Ins. Thickness =	0.100 m
Total Ins. Thickness <sup>(1)</sup> =	0.400 m
<sup>(1)</sup> : Excluding mastic and hull	

	FLAT WALL AREA	TRANSVERSE CORNERS		CARGO TANKS VOLUME (At 100%)	TANK INDIVIDUAL HEAT ENERGY AT STEADY STATE Q = Cp.A.ΔT/2	
		Length	Area (Primary)		WITHOUT FITTINGS	WITH FITTINGS
TANK N° 1	574 m <sup>2</sup>	146 m	126 m <sup>2</sup>	929 m <sup>3</sup>	6471 MJ	6759 MJ
TANK N° 2	574 m <sup>2</sup>	146 m	126 m <sup>2</sup>	929 m <sup>3</sup>	6471 MJ	6759 MJ
OVERALL	1148 m <sup>2</sup>	291 m	252 m <sup>2</sup>	1857 m <sup>3</sup>	12943 MJ	13518 MJ
DESIGN SAFETY MARGIN (%) =	5	DESIGN OVERALL HEAT CAPACITY INCLUDING 6 TONS FITTINGS =			14190	MJ

# 1 860 m<sup>3</sup> LNG Bunker ship for Argos

## CONTAINMENT SYSTEM DESIGN STUDIES

### SECTION 1 : DESIGN ANALYSES

#### Section 1.1 : Cargo Containment Heat transfer and design boil-off rate

01			First Issue	12/09/2014	VG VGU	MFI	AMA
REVISION	LABEL	ECR NBR	DESCRIPTION	DATE DD/MM/YYYY	BY	CHECKED	APPROVED

#### TECHNICAL DIVISION

 <p>1, route de Versailles 78470 St-Rémy-lès-Chevreuse - FRANCE</p>	1 860 m <sup>3</sup> LNG Bunker ship for Argos	
	TO BE APPLIED TO HULL NUMBERS : SEE DOC B011 TD LIST	MARK III SYSTEM
	HEAT TRANSFER AND DESIGN BOIL-OFF RATE	
	B011 TKI ANA 00010	
	<small>This document contains information resulting from testing, experience and know-how of GTT, which are protected under the legal regime of undisclosed information and trade secret (notably TRIPS Art. 39) and under Copyright law. This document is strictly confidential and the exclusive property of GTT. It cannot be copied, used, modified, adapted, disseminated, published or communicated, in whole or in part, by any means, for any purpose, without express prior written authorization of GTT. Any violation of this clause may give rise to civil or criminal liability - © GTT, 2010-2014</small>	
PAGE: 1	NBR OF PAGES: 7	
SCALE: None	SHEET SIZE: A4	



1860 m<sup>3</sup> LNG Bunker ship for Argos

HEAT TRANSFER AND DESIGN BOIL-OFF RATE

CONTAINMENT SYSTEM DESIGN STUDIES

**B011 TKI ANA 00010**

Revision : 01

12/09/2014

Page : 2 / 7

## REVISION SHEET

REV.	Page Nbr																																																	
	01	02	03	04	05	06	07	08	09	10	11	12	13	14	15	16	17	18	19	20	21	22	23	24	25	26	27	28	29	30	31	32	33	34	35	36	37	38	39	40	41	42	43	44	45					
01	X	X	X	X	X	X	X																																											
-																																																		
-																																																		
Sheets affected by the current revision																																																		



1860 m<sup>3</sup> LNG Bunker ship for Argos

HEAT TRANSFER AND DESIGN BOIL-OFF RATE

CONTAINMENT SYSTEM DESIGN STUDIES

B011 TKI ANA 00010

Revision : 01

12/09/2014

Page : 3 / 7

## CONTENTS

1	INTRODUCTION .....	4
2	ASSUMPTIONS .....	4
3	CALCULATION METHOD .....	5
3.1	COMPARTMENTS TEMPERATURE.....	5
3.2	BOIL-OFF RATE DETERMINATION .....	6
4	RESULTS .....	6
	ANNEXE 1 .....	7



1860 m<sup>3</sup> LNG Bunker ship for Argos

HEAT TRANSFER AND DESIGN BOIL-OFF RATE

CONTAINMENT SYSTEM DESIGN STUDIES

B011 TKI ANA 00010

Revision : 01

12/09/2014

Page : 4 / 7

## 1 INTRODUCTION

On LNG bunker ship, the heat inflow coming from the outside environmental conditions into the cargo tanks through the structural arrangement surface areas and through the insulation system causes gas production by latent vaporisation of the LNG.

The aim of this note is to evaluate the boil-off gas production rate in service.

## 2 ASSUMPTIONS

The following assumptions and conditions are considered for boil-off rate calculations. They are based on IMO conditions and special requirements of the specification.

### ▪ LNG in contact with primary barrier

### ▪ Environmental conditions :

- Air Temperature : 45°C
- Water Temperature : 32°C

### ▪ LNG characteristics :

- Tanks filling ratio : 98 %
- Composition: Pure methane CH<sub>4</sub>
- Temperature : - 161.5 °C
- Specific density : 425 kg/m<sup>3</sup>
- Latent heat of vaporisation : 511 kJ/kg

The insulation thermal conductivity curves, used for the calculations are described in document "B011 TANK ANA 00020 rev. 01". These curves are based on homologation batches of HANKUK CARBON R.PUF expanded with the help of HFC245fa are referenced as 9CSM type for both primary and secondary insulations.



1860 m<sup>3</sup> LNG Bunker ship for Argos

HEAT TRANSFER AND DESIGN BOIL-OFF RATE

CONTAINMENT SYSTEM DESIGN STUDIES

B011 TKI ANA 00010

Revision : 01

12/09/2014

Page : 5 / 7

## 3 CALCULATION METHOD

### 3.1 COMPARTMENTS TEMPERATURE

First, temperatures of double hull compartments and cofferdams are necessary in order to evaluate the temperature difference from one side of the insulation to the other. Then, it will be possible to determine the heat transfer rate.

Calculations led to get the temperatures are based on the method explained in the document "B011 TANK ANA 00020 (Temperature charts, steel grade selection at vicinity of the tank), rev. 01", with the above conditions.

This calculation method can be summarised as follows:

- For each of the three compartments of the double hull, the heat transfer rate  $\phi_i$  is calculated through each of the elementary exchange area;
- By applying the equilibrium equation to each of these compartments, the temperature inside the compartment can be calculated.
- Temperature of double hull is then estimated, considering the two heat transfer modes (conduction and convection).





1860 m<sup>3</sup> LNG Bunker ship for Argos

HEAT TRANSFER AND DESIGN BOIL-OFF RATE

CONTAINMENT SYSTEM DESIGN STUDIES

B011 TKI ANA 00010

Revision : 01

12/09/2014

Page : 6 / 7

### 3.2 BOIL-OFF RATE DETERMINATION

The heat transfer rate is evaluated for each zone of the double hull, following the equations below:

$$\begin{cases} \varphi_i = U_i S_i \Delta T \\ \varphi_j = U_j L_j \Delta T \end{cases}$$

Where  $\varphi_{i,j}$  are the heat transfer rates through to the surface  $S_i$  or the corner  $L_j$ ;  
 $U_i$  is the heat transfer coefficient corresponding to  $S_i$ ;  
 $U_j$  is the heat transfer coefficient corresponding to  $L_j$ .

For each cargo tank, the total heat transfer  $\varphi$  is the sum of all the local heat transfers:

$$\varphi = \sum_i \varphi_i + \sum_j \varphi_j .$$

The values of the heat transfer coefficients depend on several parameters, e.g. the location of the compartment, the nature of insulation (panel or corner)...

They are subject to constant checking and improvements according to insulation systems design progress.

Once the overall heat transfer rate is calculated, the boil-off rate is got from the following formula:

$$\text{B.O.R.} = \frac{\varphi}{d * V * L} * 3600 * 24$$

Where  $d$  and  $L$  represent respectively the density and vaporisation latent heat of the methane;  
 $V$  is the cargo capacity (corresponding to 98.0% of the total tank capacity).

## 4 RESULTS

The nominal boil-off rate predictions are given in the table below. Results show that, taking into account the average thermal conductivity of RPUF expanded with HFC 245fa, the design boil-off rate of 0.47% per day is fully achieved.



1860 m<sup>3</sup> LNG Bunker ship for Argos

**HEAT TRANSFER AND DESIGN BOIL-OFF RATE**

**CONTAINMENT SYSTEM DESIGN STUDIES**

**B011 TKI ANA 00010**

Revision : 01

12/09/2014

Page : 7 / 7

## ANNEXE 1

External Ambient Conditions : IGC Code		Insulation Data :		Methane and Operating Data :	
- Air Temperature =	45.0 °C	Secondary Ins. Thickness =	0.300 m	Cargo temperature	-161.5 °C
- Water Temperature =	32.0 °C	Primary Ins. Thickness =	0.100 m	Density =	425 kg/m <sup>3</sup>
- Aft cofferdam steel plating temperature =	31.6 °C	Total Ins. Thickness <sup>(1)</sup> =	0.400 m	Vaporiz. Latent Heat =	511 kJ/kg
- FWD cofferdam steel plating temperature =	31.6 °C			Tank Filling Ratio =	98.0 %
- Central cofferdams steel plating temperature =	27.3 °C				

<sup>(1)</sup> : Excluding mastic and hull

	FLAT WALL AREA	TRANSVERSE CORNERS		CARGO TANK VOLUME (At 100%)	HEAT TRANSFER RATE With LNG at -161.5°C	TANK INDIVIDUAL B.O.R (At 98% tank capacity)
		Length	Area (Primary)			
TANK N° 1	596 m <sup>2</sup>	146 m	126 m <sup>2</sup>	929 m <sup>3</sup>	10030 W	0.439 % Day
TANK N° 2	596 m <sup>2</sup>	146 m	126 m <sup>2</sup>	929 m <sup>3</sup>	10030 W	0.439 % Day
<b>OVERALL</b>	<b>1193 m<sup>2</sup></b>	<b>291 m</b>	<b>252 m<sup>2</sup></b>	<b>1857 m<sup>3</sup></b>	<b>20059 W</b>	<b>0.439 % Day</b>
<b>DESIGN DAILY BOIL-OFF RATE =</b>						<b>0.470 %</b>

**Note** : Contractual B.O.R to be measured in accordance with GTT Specifications (Steady regime, seastate condition,...)

Reference : B011 TANK CDC 00010 "LNG FUEL THERMAL EFFICIENCY TEST PROCEDURE", rev01

# 1860 m<sup>3</sup> LNG BUNKER ship for ARGOS

## CONTAINMENT SYSTEM DESIGN STUDIES

### SECTION 1 : DESIGN ANALYSES

**Section 1.1 : Cargo Containment  
Temperature chart, steel grade selection at vicinity of  
the tank**

01			First issue	12/09/2014	VG VGU	# MFI	AMA AMA
REVISION	LABEL	ECR NBR	DESCRIPTION	DATE DD/MM/YYYY	BY	CHECKED	APPROVED

#### TECHNICAL DIVISION

  1, route de Versailles 78470 St-Rémy-lès-Chevreuse - FRANCE	1 860 m <sup>3</sup> LNG Bunker ship for ARGOS	
	TO BE APPLIED TO TANK NUMBERS : SEE DOC B011 TD LIST	MARK III SYSTEM
	TEMPERATURE CHART, STEEL GRADE SELECTION AT VICINITY OF THE TANK	
	B011 TANK ANA 00020	
	This document contains information resulting from testing, experience and know-how of GTT, which are protected under the legal regime of undisclosed information and trade secret (notably TRIPS Art. 39) and under Copyright law. This document is strictly confidential and the exclusive property of GTT. It cannot be copied, used, modified, adapted, disseminated, published or communicated, in whole or in part, by any means, for any purpose, without express prior written authorization of GTT. Any violation of this clause may give rise to civil or criminal liability - © GTT, 2010-2014	
PAGE: 1	NBR OF PAGES : 11	
SCALE: None	SHEET SIZE: A4	



1860 m<sup>3</sup> LNG Bunker ship for Argos

**TEMPERATURE CHART, STEEL GRADE SELECTION  
AT VICINITY OF THE TANK**

**CONTAINMENT SYSTEM DESIGN STUDIES**

**B011 TANK ANA 00020**

Revision : 01

**12/09/2014**

**Page : 2 / 11**

## REVISION SHEET

REV.	Page Nbr																																																	
	01	02	03	04	05	06	07	08	09	10	11	12	13	14	15	16	17	18	19	20	21	22	23	24	25	26	27	28	29	30	31	32	33	34	35	36	37	38	39	40	41	42	43	44	45					
01	X	X	X	X	X	X	X	X	X	X	X																																							
-																																																		
-																																																		
Sheets affected by the current revision																																																		



1860 m<sup>3</sup> LNG Bunker ship for Argos

**TEMPERATURE CHART, STEEL GRADE SELECTION  
AT VICINITY OF THE TANK**

**CONTAINMENT SYSTEM DESIGN STUDIES**

**B011 TANK ANA 00020**

Revision : 01

12/09/2014

Page : 3 / 11

## CONTENTS

<b>1 INTRODUCTION</b>	<b>4</b>
<b>2 ASSUMPTIONS</b>	<b>4</b>
2.1 STRUCTURAL ARRANGEMENT	4
2.2 ENVIRONMENTAL CONDITIONS	4
<b>3 CALCULATION METHOD</b>	<b>6</b>
3.1 PRINCIPLES	6
3.2 HEAT TRANSFER COEFFICIENTS	6
3.3 EQUILIBRIUM TEMPERATURES CALCULATION	7
3.4 INNER HULL STEEL PLATING	7
<b>4 RESULTS</b>	<b>8</b>
4.1 TEMPERATURES OF COFFERDAMS	8
4.2 TEMPERATURES OF DOUBLE HULL COMPARTMENTS	8
4.3 STEEL GRADE SELECTION	10
APPENDIX 1: DOUBLE HULL COMPARTMENTS: HEAT INFLOW ANALYSIS	11



1860 m<sup>3</sup> LNG Bunker ship for Argos

**TEMPERATURE CHART, STEEL GRADE SELECTION  
AT VICINITY OF THE TANK**

**CONTAINMENT SYSTEM DESIGN STUDIES**

**B011 TANK ANA 00020**

Revision : 01

**12/09/2014**

**Page : 4 / 11**

## 1 INTRODUCTION

This note deals with the temperatures of the double hull compartments, calculated in the most severe conditions (as defined by the IMO rules) in order to select the steel grades of these compartments according to the table 6.5 of IGC Code.

## 2 ASSUMPTIONS

### 2.1 STRUCTURAL ARRANGEMENT

Thermal calculations have been performed thanks to the description of the scantling as detailed in the following drawings:

- Midship Section (document Rommerts ship design, « Midship Sections LNG-GTT Middle part FR57-145 » dated 12/03/2014);
- Cofferdam bulkheads:
  - Frames 57 & 59 section (Rommerts ship design drawing “Cofferdam fr.57,58,59” dated 12/03/2014);
  - Frames 100 & 102 section (Rommerts ship design drawing “Cofferdam fr.100,101,102” dated 12/03/2014);
  - Frames 143 & 145 section (Rommerts ship design drawing “Cofferdam fr.143,144,145” dated 12/03/2014);
- General Arrangement (Rommerts ship design drawing “General Arrangement (GTT tanks)” dated 12/12/2013);

### 2.2 ENVIRONMENTAL CONDITIONS

Specifications used to lead the calculations are extracted from IMO:

- Air temperature = 5°C;
- Water temperature = 0°C;
- No Wind;
- LNG in contact with the secondary barrier ( $T_{LNG} = -163^{\circ}C$ ).

The temperature of the fuel oil cargo tanks (fore & aft) is assumed equal to:

- $T_{CT} = 5^{\circ}C$ .

The draft of the ship has been taken equal to 4.5 m.



1860 m<sup>3</sup> LNG Bunker ship for Argos

**TEMPERATURE CHART, STEEL GRADE SELECTION  
AT VICINITY OF THE TANK**

**CONTAINMENT SYSTEM DESIGN STUDIES**

**B011 TANK ANA 00020**

Revision : 01

12/09/2014

Page : 5 / 11

The insulation thermal conductivity properties, used for this thermal analysis, are based on homologation batches of HANKUK CARBON R.PUF expanded with the help of HFC 245fa referenced as 9CSM type for both primary and secondary insulations.

As a reference, the following curve shows measurements carried out in GTT laboratory in 2013 (cf. Figure 1). It should be subject to adjustments according to the results of future productions.

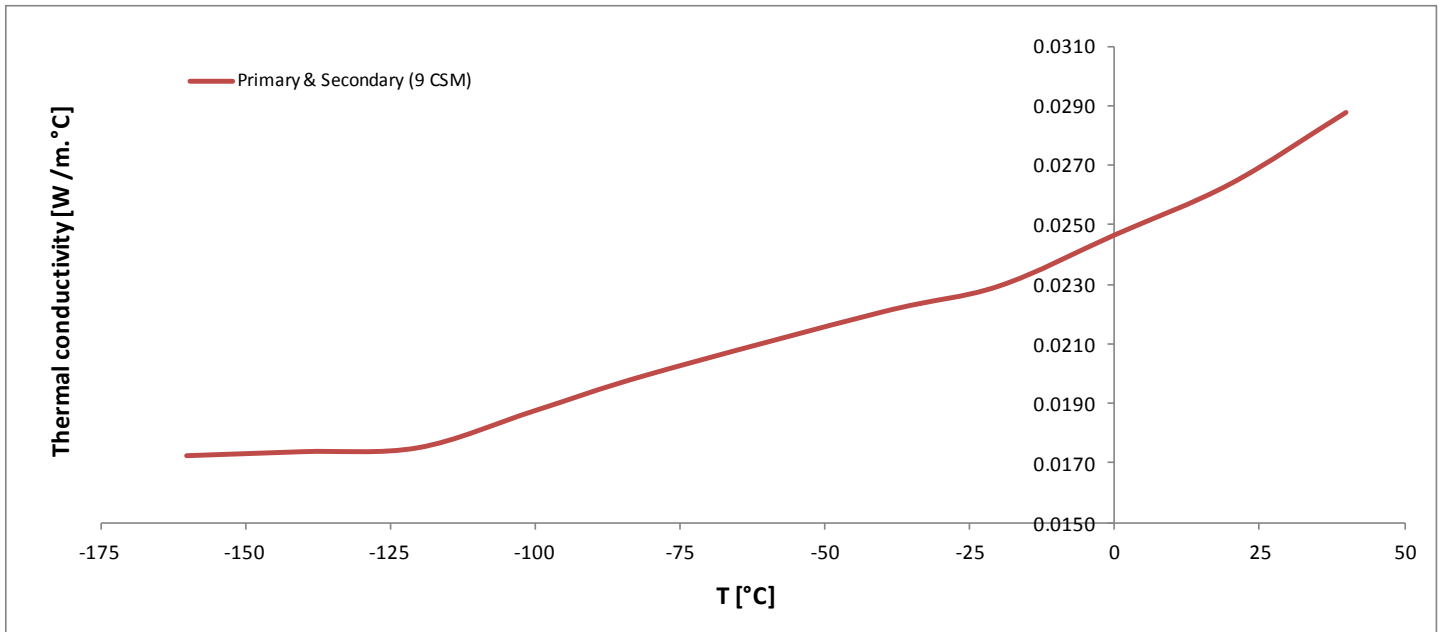

**Figure 1: Average thermal conductivity curve of R-PUF expanded with HFC 245fa.**



1860 m<sup>3</sup> LNG Bunker ship for Argos

TEMPERATURE CHART, STEEL GRADE SELECTION  
AT VICINITY OF THE TANK

CONTAINMENT SYSTEM DESIGN STUDIES

B011 TANK ANA 00020

Revision : 01

12/09/2014

Page : 6 / 11

## 3 CALCULATION METHOD

### 3.1 PRINCIPLES

For each of the three compartments of the double hull (cf. Appendix 1), the net heat transfer results from the difference between the following heat transfer rates:

- Incoming heat received from the outer hull steel plating in contact with external air or water or from the warmer adjacent compartments;
- Outgoing heat yielded to the inner hull steel plating (and onwards, to the LNG cargo through the insulation system) and to the adjacent colder compartments.

For each elementary exchange area  $S_i$  composing the compartment volume, the heat transfer rate  $\Phi_i$  can be expressed as follows:

$$\Phi_i = U_i \cdot S_i \cdot \Delta T_i \quad [W]$$

where :

$U_i$ : Overall heat transfer coefficient [W/m<sup>2</sup>.°C]

$S_i$ : Exchange area of elementary boundary surface n° i [m<sup>2</sup>]

$\Delta T_i$ : Temperature difference across boundary surface n° i [°C]

$$\Delta T_i = T_{\text{compt.}} - T_{\text{ext.i}}$$

with :  $T_{\text{compt.}}$  : temperature inside compartment

$T_{\text{ext.i}}$  : external temperature corresponding to surface n° i

For every compartment, in steady state regime, the energy conservation law can be written as follows:

$$\Sigma \Phi_i = 0 \quad \text{for } i = 1 \text{ to } n.$$

The above equation (also known as the “heat diffusion equation”) gives the equilibrium temperature inside the considered compartment  $T_{\text{compt.}}$

### 3.2 HEAT TRANSFER COEFFICIENTS

The overall heat transfer coefficient  $U_i$  reflects the two heat transfer modes which prevail in this case:

- conduction,
- convection (internal free convection due to the air filling the compartment, external convection due to air or water), and can then be expressed as follows :

$$\frac{1}{U_i} = \frac{1}{h_{i1}} + \frac{e_i}{k_i} + \frac{1}{m \cdot h_{i2}} \quad [W/m^2 \cdot ^\circ C]^{-1}$$

where:

$e_i$  wall thickness of boundary surface n° i [m];

$k_i$  thermal conductivity of the wall material [W/m.°C];

$h_{i1,2}$  convection heat transfer coefficients on each side of the boundary wall n° i;

$m$  corrective coefficient for taking into account the fin effect of the stiffeners.





1860 m<sup>3</sup> LNG Bunker ship for Argos

**TEMPERATURE CHART, STEEL GRADE SELECTION  
AT VICINITY OF THE TANK**

**CONTAINMENT SYSTEM DESIGN STUDIES**

**B011 TANK ANA 00020**

Revision : 01

12/09/2014

Page : 7 / 11

### 3.3 EQUILIBRIUM TEMPERATURES CALCULATION

From the scantling of the midship section, it is possible to determine, for each compartment and on each of its sides, the values of  $U_i$  and  $S_i$ . Then, equilibrium temperatures – i.e. air inside compartment  $T_{\text{compt}}$  and steel plating  $T_{\text{ext},i}$  can be calculated by solving the heat diffusion equation:

$$\Sigma \Phi_i = \Sigma U_i \cdot S_i \cdot [T_{\text{compt}} - T_{\text{ext},i}] = 0 \quad \text{for } i = 1 \text{ to } n$$

### 3.4 INNER HULL STEEL PLATING

The same approach can be adopted to determine directly the inner hull steel plating temperature once the air temperature inside the compartment  $T_{\text{compt}}$  is known. The heat transfer rate across an exchange area  $S_j$  on the inner hull can be expressed as follows :

$$\Phi_j = h_{j2} \cdot m \cdot S_j \cdot [T_{\text{compt}} - T_{\text{ihsteel}j}] \quad \text{on compartment side}$$

$$\Phi_j = k_j / e_j \cdot S_j \cdot [T_{\text{ihsteel}j} - (-163)] \quad \text{on insulation side}$$

From the above equation comes the following :

$$T_{\text{ihsteel } j} = T_{\text{compt}} - [(k_j / e_j) / (k_j / e_j + h_{j2} m)] [T_{\text{compt}} + 163]$$

where :

$T_{\text{ihsteel } j}$  = inner hull steel plating temperature for heat exchange surface n°j

$S_j$  = area of heat exchange surface n°j

$h_{j2}$  = convection heat transfer coefficient for internal side of compartment

$m$  = corrective factor as defined in §3.2.

$k_j$  = overall thermal conductivity of the insulation system next to heat exchange surface n° j;

$e_j$  = 0.300 m (insulation thickness).



1860 m<sup>3</sup> LNG Bunker ship for Argos

**TEMPERATURE CHART, STEEL GRADE SELECTION  
AT VICINITY OF THE TANK**

**CONTAINMENT SYSTEM DESIGN STUDIES**

**B011 TANK ANA 00020**

Revision : 01

12/09/2014

Page : 8 / 11

## 4 RESULTS

### 4.1 TEMPERATURES OF COFFERDAMS

Several cases have to be distinguished:

1. The cofferdam n°1, which is located between the tank n°1 and the fuel oil cargo tank 1. One of its specificities is the absence double deck and double bottom.
2. The cofferdam n°2, which is in contact with the tanks no 1 & 2. It has the shape of the LNG tanks.
3. The cofferdams 3, which is located between the tank n°2 and the fuel oil cargo tank 2. It has the same shape as cofferdam n°1.

All the flows are symbolised in annex. Results are summed up in the table below:

	Cofferdam 1		Cofferdam 2		Cofferdam 3	
	Temp. inside compartment	Temp. of inner hull	Temp. inside compartment	Temp. of inner hull	Temp. inside compartment	Temp. of inner hull
IGC Conditions	0.7°C	-1.1°C	-5.4°C	-7.1°C	0.4°C	-1.4°C

### 4.2 TEMPERATURES OF DOUBLE HULL COMPARTMENTS

The following figure sums up the temperatures calculated in the Midship Section, in the design conditions (IMO conditions).



1860 m<sup>3</sup> LNG Bunker ship for Argos

**TEMPERATURE CHART, STEEL GRADE SELECTION  
AT VICINITY OF THE TANK**

**CONTAINMENT SYSTEM DESIGN STUDIES**

**B011 TANK ANA 00020**

Revision : 01

12/09/2014

Page : 9 / 11

**IGC CONDITIONS**

External air temperature      5 °C  
 Wind                                      0  
 Water temperature                0 °C  
 LNG on Secondary barrier

Insulation thickness		
Secondary	<b>0.3000</b>	m
Primary	<b>0.1000</b>	m

LNG Cargo Temperature  
**-163.0 °C**

<b>-0.8</b>	Air temperature inside compartment (°C)
<b>-2.2</b>	Inner Hull Steel Plating (°C)
<b>-0.1</b>	Outer Hull Steel Plating (°C)

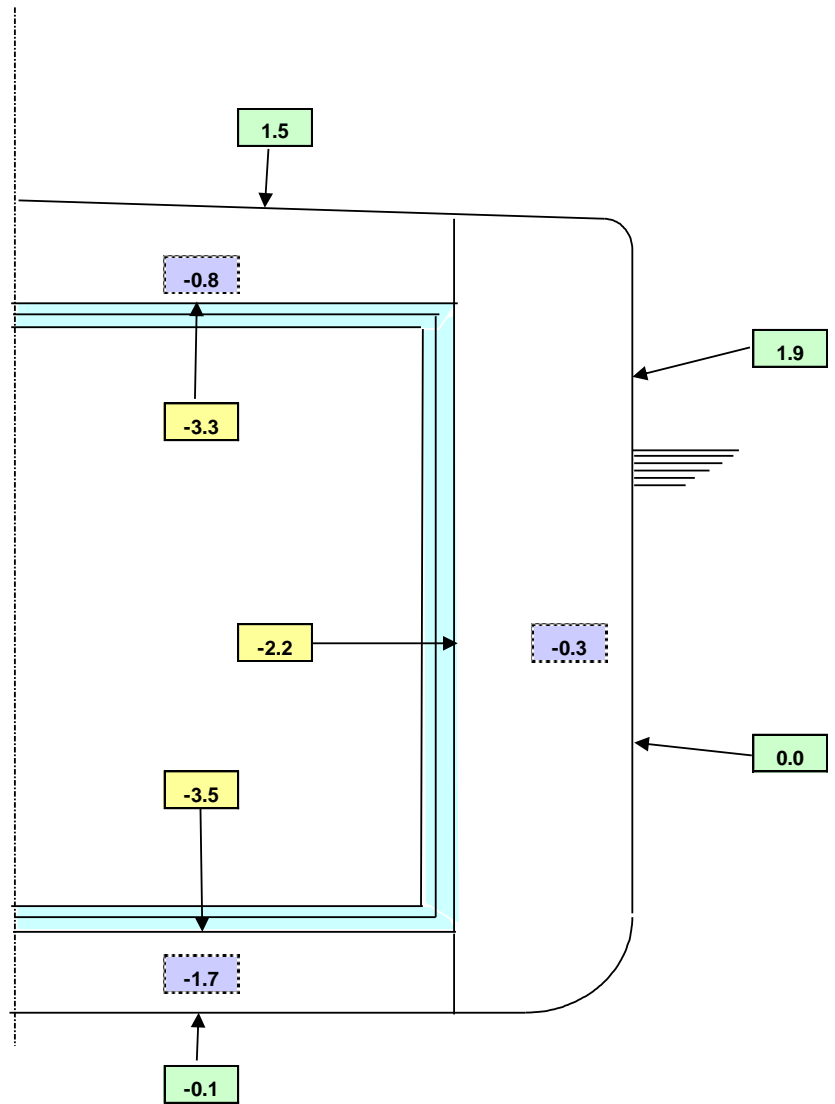
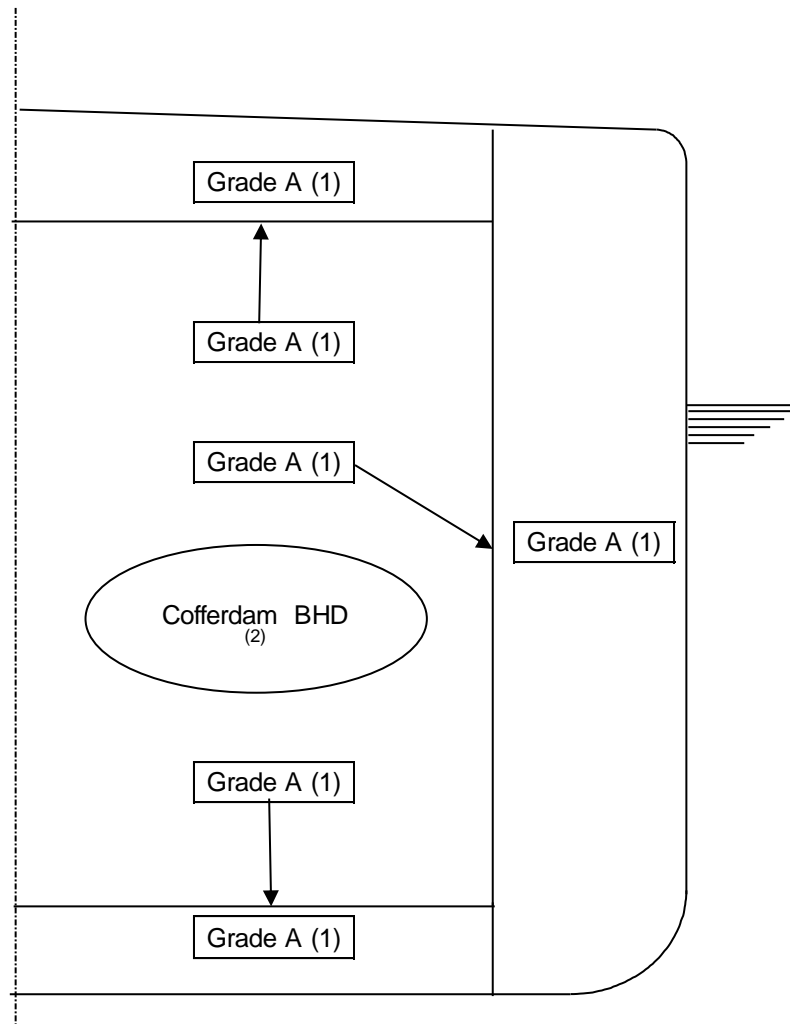

**Figure 2: Double hull compartments temperatures**



### 4.3 STEEL GRADE SELECTION

Results are summed up on the figure 3. They are based on the table 6.5 of IGC Code and the calculated temperatures.



Longitudinals attached to inner hull: same grade as per attached plate.

Members connected to both inner and outer hulls shall be suitable with the mean linear temperature of inner and outer hulls.

- (1) Grade A for thickness up to 15mm, for higher thickness (up to 25mm) use of grade B necessary.
- (2) For Cofferdam 1 & 3: Grade A for thickness up to 15mm, for higher thickness (up to 25mm) use of grade B necessary.  
For Cofferdam 2: Grade B for thickness up to 20mm, for higher thickness (up to 25mm) use of grade D necessary.

Figure 3: Steel grade selection in way of cargo tanks



1860 m<sup>3</sup> LNG Bunker ship for Argos

TEMPERATURE CHART, STEEL GRADE SELECTION  
AT VICINITY OF THE TANK

CONTAINMENT SYSTEM DESIGN STUDIES

B011 TANK ANA 00020

Revision : 01

12/09/2014

Page : 11 / 11

## APPENDIX 1: DOUBLE HULL COMPARTMENTS: HEAT INFLOW ANALYSIS

