

64th GRPE Session

Development of IWVTA system and
involvement of the Working Parties:

CANDIDATE ITEMS FOR TECHNICAL REGULATIONS
APPLICABLE TO IWVTA AND GUIDELINE FOR GRS
TO REVIEW TECHNICAL REGULATIONS
APPLICABLE TO IWVTA

1. Introduction

2. Latest Situation of WP.29 IWVTA Informal Group activities

2-1 Roadmap

2-2 Envisioned new structure for the revised 1958 Agreement

2-3 Concept of UN Regulation No.0

2-4 Regulation No.0

3. The role of IWVTA Ambassador

4. The schedule to review and/or develop technical regulations applicable to IWVTA

5. The candidate items for technical regulations applicable to IWVTA to be reviewed and/or developed by GRSP

6. Explanation of the flow chart of the guideline for GRs to review and/or develop technical regulations applicable to IWVTA

-Step 0

-Step 1/2

-Step 3

1.Introduction

Our Goal

- * At present, various vehicle certification systems exist for different countries in the world. We aim to establish a truly global type approval system and realize mutual recognition of approval among many different nations.
- * Specifically, we aim to upgrade the current approval system under the international agreement (1958 Agreement), which covers “mutual recognition of approval of vehicle construction and equipment”, to the “whole vehicle” level.

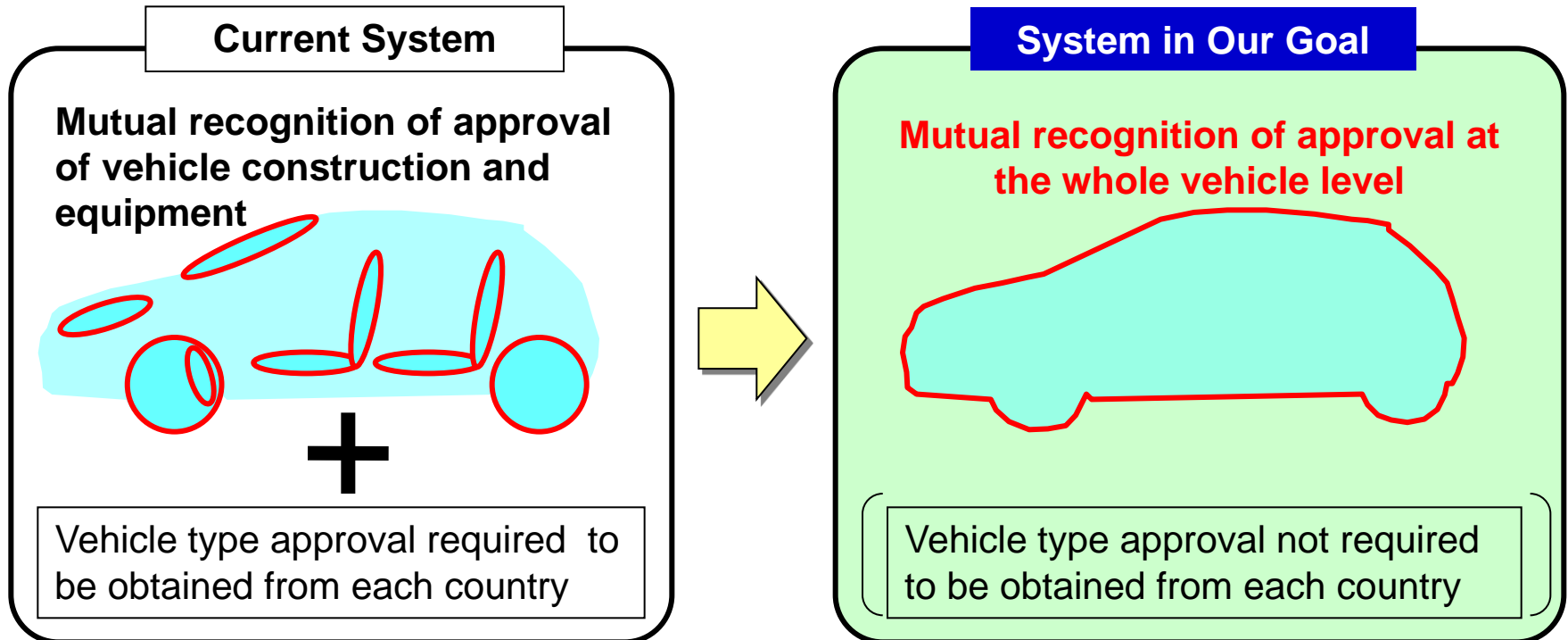

Benefits of Establishment of Mutual Recognition of IWVTA

If the mutual recognition of vehicle type approval (including all technical requirements on a whole vehicle) is established under the UN,

- (1) Benefits from harmonizing regulations, while maintaining road safety and environmental protection, will increase, further promoting Contracting Parties' activities for harmonizing regulations related to vehicle construction and equipment, etc.
- (2) It will serve as a model system that would help the aligned vehicle type approval system to be established around the world and accelerate the activities for realization of mutual recognition system based on the type approval.

Government (G)

- ◆ Through harmonization, advanced safety and environmental regulations will be implemented internationally.
- ◆ Testing and approval procedures will be streamlined.
- ◆ Establishment of vehicle type approval system in developing countries, etc. will be facilitated.

Industry (I)

- ◆ Costs and man-hours required by differing development and certification procedures for complying with regulations of each product destination will be reduced.
- ◆ Resource can be spared for development of improved safety and environmental technologies.

User

Wider availability of safer, more environmentally-friendly vehicles with reasonable prices

Realization of sustainable mobility society

*Beneficial for both G and I.
*Should be realized through G-I collaboration.

Japan's Proposal to the UN (March 2010)

Outline of the proposal

To build infrastructure for establishing, in the future, the “system concerning mutual recognition of IWVTA” under WP.29 through utilization of the “agreement on mutual recognition of approval for motor vehicle equipment and parts”

EU's Proposal to the UN (March 2010)

Outline of the proposal

To revise 1958 agreement to update it considering the current situation and also make it more attractive to emerging countries

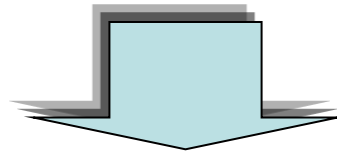

Outcome at WP29 in March 2010

Informal group to be set up to develop the roadmap to carry out the above;

Revision of 1958 agreement and establishing IWVTA

(Roadmap was approved by WP.29 in November 2011)

Framework for Implementing Activities at WP.29

UN/ECE/WP.29

IWVTA Informal Group

Task: Development of roadmap (approved by WP.29 in November 2011)

Chairman: Mr. Gauvin (WP.29 Vice-chairman)

Co-vice-chairmen: Mr. Renders (EU)  **Revision of the 1958 Agreement**

(Quality of rulemaking, type-approval procedure and mutual recognition, conformity of production, qualification of technical services, quorum for adoption of new Regulations and amendments, etc.)

Mr. Onoda (MLIT)  **Preparation of IWVTA**

(Technical requirements, types, categories, weights, definition of dimensions, specifications of application procedures, etc. necessary for IWVTA)

Technical Secretary: Mr. Oshita (JASIC)

Time of meeting: Friday of the week prior to WP.29 (mostly)

Venue: Paris (mostly)

Members: Any organization that attends WP.29

(Currently about 30 members from government and industry)

1. Introduction

2. Latest Situation of WP.29 IWVTA Informal Group activities

2-1 Roadmap

2-2 Envisioned new structure for the revised 1958 Agreement

2-3 Concept of UN Regulation No.0

2-4 Regulation No.0

3. The role of IWVTA Ambassador

4. The schedule to review and/or develop technical regulations applicable to IWVTA

5. The candidate items for technical regulations applicable to IWVTA to be reviewed and/or developed by GRSG

6. Explanation of the flow chart of the guideline for GRs to review and/or develop technical regulations applicable to IWVTA

-Step 0

-Step 1/2

-Step 3

2. Latest situation of WP.29 IWVTA Informal Group activity

Items approved by WP29 in November 2011 and in March 2012

1. Roadmap of revising 1958 agreement and establishing IWVTA (UN Regulation No.0) until 2016
2. Inventory for the revision of the 1958 Agreement
3. Concept of IWVTA (UN Regulation No.0)
4. Candidate of technical regulation list necessary for IWVTA, how to develop technical regulation itself in each GR (Experts group) and finalize the list itself.

2-1 Roadmap for revising the 1958 Agreement and establishing IWVTA

- At the 5th meeting of IWVTA-IG held in March 2011, agreement was reached on the working procedure and working schedule for the drafting of IWVTA regulations.
- The Informal Group agreed that, for the time being, it would focus on regulations on passenger cars, which are most needed.

	2011	2012	2013	2014	2015	2016
	9 11	6 11	3		6	
1. IWVTA						
Candidates for items for IWVTA	IWVTA-IG is to prepare candidates for items for IWVTA.					
Amend existing regulations and/or make new regulations	Based on the item list, each GR examines UN Regulations (to be created or amended as necessary).					
IWVTA concept (including UN R0 at WP.29)		Making draft UN R0	Discuss the draft UN R0 at WP.29			
Amend IWVTA-related agreements (if necessary)					Amend agreements?	
2. Amend the 1958 Agreement						
Application, grant, modification, withdrawal of approval; new technologies, COP, safeguard, etc.	Discuss and agree on the inventory	Report to WP.29	Draft proposal	Report to WP.29		

2-2 Envisioned new structure of the to-be-revised 1958 Agreement

Text of the 1958 Agreement (amended)

Appendices

Appendix 1 Composition and Rules of Procedure of the Administrative Committee (amended)

Appendix 2 Conformity of Production Procedure (amended)

Placeholder Procedure for Type Approval
〔(R.E.3) Annex 7 (amended)〕

Relevant elements of WP29/1044 or later revision
Relevant elements of WP29/1059 or later revision

ANNEX (Regulations) - Addendum to 1958 Agreement

No.0 IWVTA : Vehicle approval requirements (New UN Regulation)

No.1

⋮

No.126

2-3 Concept of UN Regulation No.0 (IWVTA)

Basic idea is to establish IWVTA under the 1958 Agreement

-IWVTA should be established in line with the principle of the current 58 agreement, i.e.: "the CPs can choose the UN Regulations they apply"

-Consequently, the new concept of "the Regulation on IWVTA" was proposed as "UN Regulation No.0".

2-4 UN Regulation No.0 (first Draft : Working Doc.IWVTA-09-08e)

Regulation No. 0
UNIFORM PROVISIONS CONCERNING THE INTERNATIONAL APPROVAL OF WHOLE VEHICLES
Regulation No. 0
UNIFORM PROVISIONS CONCERNING THE INTERNATIONAL APPROVAL OF WHOLE VEHICLES
Draft History
Preamble
Contents
1.Scope
2.Definitions
3.Application for approval
4.Approval
5.Specifications
6.Tests
7.Modification of vehicle type and extension of approval
8.Conformity of production
9.Penalties for non-conformity of production
10.Production definitely discontinued
11.Names and addresses of Technical Services responsible for conducting approval tests and of Administrative Departments
12.Introductory and transitional provisions
Annex 1: Communication
Part A: Vehicles of category M1
SECTION I
SECTION II
Annex 2: Arrangement of the approval mark
Annex 3: Procedures to be followed during I-WVTA of vehicles
Annex 4: List of requirements for the purpose of I-WVTA: List of regulatory acts
Part A: Requirements for vehicles of category M1
Table 1: List of mandatory requirements
Table 2: List of if-fitted requirements
Table 3: List of alternative requirements for a I-WVTA with limited validity
Table 4: List of national or regional requirements for I-WVTA
Annex 5: Information document for the purpose of I-WVTA of vehicles
General prescriptions
Part I: Identification of the variants and versions
Part II: Information document
A. Vehicles of category M1
Part III: Type approval numbers
Annex 6: Certificate of conformity
Model A: UN-Certificate of conformity for complete vehicles of category M1
SIDE 1
SIDE 2
Appendix 1: Model translation sheet for the certificate of conformity
Annex 7: Definition of the vehicle type
Part A: Vehicles of category M1

ANNEX4:
List of technical regulation necessary for IWVTA

Action of IWVTA Informal group from now on

First draft was presented by OICA for the future discussion. This will be discussed and drafted in working team under WP29 IWVTA informal group From now on.

Final draft will be presented in March WP29 in 2013

- 1. Introduction**
- 2. Latest Situation of WP.29 IWVTA Informal Group activities**
 - 2-1 Roadmap**
 - 2-2 Envisioned new structure for the revised 1958 Agreement**
 - 2-3 Concept of UN Regulation No.0**
 - 2-4 Regulation No.0**
- 3. The role of IWVTA Ambassador**
- 4. The schedule to review and/or develop technical regulations applicable to IWVTA**
- 5. The candidate items for technical regulations applicable to IWVTA to be reviewed and/or developed by GRSG**
- 6. Explanation of the flow chart of the guideline for GRs to review and/or develop technical regulations applicable to IWVTA**
 - Step 0**
 - Step 1/2**
 - Step 3**

3. The role of IWVTA Ambassador

- (1) explain the guideline at the first GR meeting to be held after the 156th WP29 session in March, 2012
- (2) monitor the progress of GR to review UN Regulations applicable to IWVTA and report it to IWVTA Informal Group
- (3) assist GR to solve the unsettled issues

- 1. Introduction**
- 2. Latest Situation of WP.29 IWVTA Informal Group activities**
 - 2-1 Roadmap**
 - 2-2 Envisioned new structure for the revised 1958 Agreement**
 - 2-3 Concept of UN Regulation No.0**
 - 2-4 Regulation No.0**
- 3. The role of IWVTA Ambassador**
- 4. The schedule to review and/or develop technical regulations applicable to IWVTA**
- 5. The candidate items for technical regulations applicable to IWVTA to be reviewed and/or developed by GRSG**
- 6. Explanation of the flow chart of the guideline for GRs to review and/or develop technical regulations applicable to IWVTA**
 - Step 0**
 - Step 1/2**
 - Step 3**

4.The schedule to review and/or develop technical regulations applicable to IWVTA

	Actions or events
June 2012 64 st GRPE	GRPE is expected to start the process to review and/or develop technical regulations applicable to IWVTA
November 2012 158 th WP29	A special meeting attended by GR Chairpersons and IWVTA Informal Group to discuss the guideline issues and to clarify open questions is planned in November 2012
June 2013 160 th WP29	Each GR must submit the status report to WP.29 in June 2013
June 2015 166 th WP29	Each GR must submit the reviewed and/or developed UN Regulations applicable to IWVTA to WP29 for consideration by June 2015

How to develop technical regulations in each GRs

Based on this guideline, each GR (Experts group of WP29) will examine the followings and will report their proposal to Informal Group.

- the validity of the identified UN Regulations
(R97, 25 for M1 etc)
- the necessity of the identified UN Regulations to be included in IWVTA
- the necessity to split the identified UN Regulations
(ESC BAS requirement from R13H, TPMS requirement from R64, etc)
- the necessity to amend the identified UN Regulations,
- the possibility to develop the unified requirements
(necessity of regional applicable regulation)
- the necessity to separate the identified UN Regulations
for the M1 category vehicles and the vehicles of the other categories

First report will be presented in June WP29 2013 and finalize them in June 2015

1. Introduction
2. Latest Situation of WP.29 IWVTA Informal Group activities
 - 2-1 Roadmap
 - 2-2 Envisioned new structure for the revised 1958 Agreement
 - 2-3 Concept of UN Regulation No.0
 - 2-4 Regulation No.0
3. The role of IWVTA Ambassador
4. The schedule to review and/or develop technical regulations applicable to IWVTA
5. The candidate items for technical regulations applicable to IWVTA to be reviewed and/or developed by GRs
6. Explanation of the flow chart of the guideline for GRs to review and/or develop technical regulations applicable to IWVTA
 - Step 0
 - Step 1/2
 - Step 3

5. The candidate items for technical regulations applicable to IWVTA to be reviewed and/or developed by GRs (Working Doc. WP29-156-21)

PROPOSAL FOR “CANDIDATE ITEMS FOR TECHNICAL REGULATIONS APPLICABLE TO INTERNATIONAL WHOLE VEHICLE TYPE APPROVAL (IWVTA)” AND “GUIDELINE FOR GRs TO REVIEW TECHNICAL REGULATIONS APPLICABLE TO IWVTA”

Submitted by the Chairman and the co-Chairmen of the WP.29 informal group on the future direction for the 1958 Agreement and IWVTA

1. The World Forum for Harmonization of Vehicles Regulations (WP.29), at its March 2010 session, decided to set up an informal group to establish an inventory of items to be addressed in a review of the 1958 Agreement and roadmap for future actions to be undertaken relating to i) the quality assurance of type approval, ii) its functional improvement, and iii) establishment of IWVTA. The inventory (list of elements to be addressed in the review of the 1958 Agreement) and the roadmap for the revision of the 1958 Agreement and introduction of IWVTA proposed by IWVTA Informal Group were approved by WP.29 at its 155th session in November, 2011. According to the roadmap, IWVTA Informal Group is to submit “candidate items for technical regulations applicable to IWVTA” and “guideline for GRs to review technical regulations applicable to IWVTA” to WP.29 at its 156 session for consideration. The target completion date for the work of the informal group shall be the 168th session of WP.29 in March 2016 as indicated in terms of reference (informal document No.WP.29-150-25) and as reflected in the roadmap (Annex 2 of informal document No.WP.29-155-27)

I. Candidate items for technical regulations applicable to IWVTA

2. The informal group selected candidate items for technical regulations applicable to IWVTA in the following procedure. The information on national or regional technical regulations submitted by EU, Russia, South Africa, Australia and Japan was summarized on a list. National regulations were sorted into 4 categories of “A”, “B”, “C” and “n”. “A”’s are those for which IWVTA Informal Group considers it appropriate to specify only one requirement as the international regulations. “B”’s are those for which IWVTA Informal Group considers it appropriate to specify several requirements as the international regulations considering the characteristics of different regions. “C”’s are those for which it is difficult to formulate justifications that they are appropriate as the international regulations. “n” means there are no national regulations for the subject. As a result of various discussions, the Chairman proposed the following approach to select technical requirements for IWVTA. (1) The subjects sorted into all “A” or “A + n” should be a basis for IWVTA and allocated to each GR for further consideration as indicated in Annex 3. (2) The subjects sorted into “A + B” should be allocated to each GR. Each GR is expected to explore the way to make a regulation to stipulate only one level of requirements wherever possible. (3) Non technical subjects should be considered by IWVTA Informal Group. (4) The subjects sorted into “C + n” should not be allocated to each GR, and their consideration should be stopped as they are considered to be inappropriate for IWVTA by IWVTA Informal Group.

3. The list of candidate items for technical regulations applicable to IWVTA is attached as Annex 1 to this document. Annex 2 is the same list of candidate items grouped into six GRs bearing responsibility for the items.

Annex 1: Candidate of technical regulation list (64 items)

- (1) IWVTA item for technical regulations with unified requirements
- (2) IWVTA items for potential technical regulations with regionally applicable requirements
- (3) IWVTA items for non-technical regulations

GR no	Item No.	Item	EU	Russia	Australia	South Africa	Japan	UN R	Notes
(1)	1	Permissible sound level	A	A	A	A	A	51	
(1)	2	Fuel tanks	A	A	n	n	A	34	
(1)	2a	Rear Protective devices	A	A	n	n	A	58	
(1)	3	Steering effort	A	A	A	n	A	79	
(1)	4	Door latches and hinges	A	A	A	A	A	11, GTR 1	
(1)	5	Audible warning	A	A	A	A	A	28	
(1)	6	Braking	A	A	A	A	A	134	GR is to check the necessity to split R134.
(1)	6a	ES	A	A	A	A	A	134 Sup. 9	
(1)	6b	BA/Brake Assist	A	A	A	A	A	134 Sup. 9	
(1)	7	Radio interference	A	A	A	A	A	10	

• •
• •
• •

**1. The candidate items for technical regulations applicable to IWVTA ([GRPE](#))
to be finalized and submitted to WP29 at its 157 session in June 2012**

No.	Items	UN Reg.	Suggested Actions, Notes
56	Emissions (Euro 5 and 6) light duty vehicles/ access to information	83	R83 Is to be amended after adoption of WLTP GTR
47	Diesel smoke	24	Validity should be discussed
56b	Diesel emissions	49	M1 of only 3.5t or more R49 Is to be amended after adoption of WHDC GTR
52	CO2 emissions/ fuel consumption	84,101	R101 supersedes R84
27	Engine power	85	
33	Air-conditioning systems	none	Necessity should be discussed.

- 1. Introduction**
- 2. Latest Situation of WP.29 IWVTA Informal Group activities**
 - 2-1 Roadmap**
 - 2-2 Envisioned new structure for the revised 1958 Agreement**
 - 2-3 Concept of UN Regulation No.0**
 - 2-4 Regulation No.0**
- 3. The role of IWVTA Ambassador**
- 4. The schedule to review and/or develop technical regulations applicable to IWVTA**
- 5. The candidate items for technical regulations applicable to IWVTA to be reviewed and/or developed by GRSG**
- 6. Explanation of the flow chart of the guideline for GRs to review and/or develop technical regulations applicable to IWVTA**
 - Step 0**
 - Step 1/2**
 - Step 3**

6. Explanation of the flow chart of the Guideline for GR to review technical regulations applicable to IWVTA

Step 0

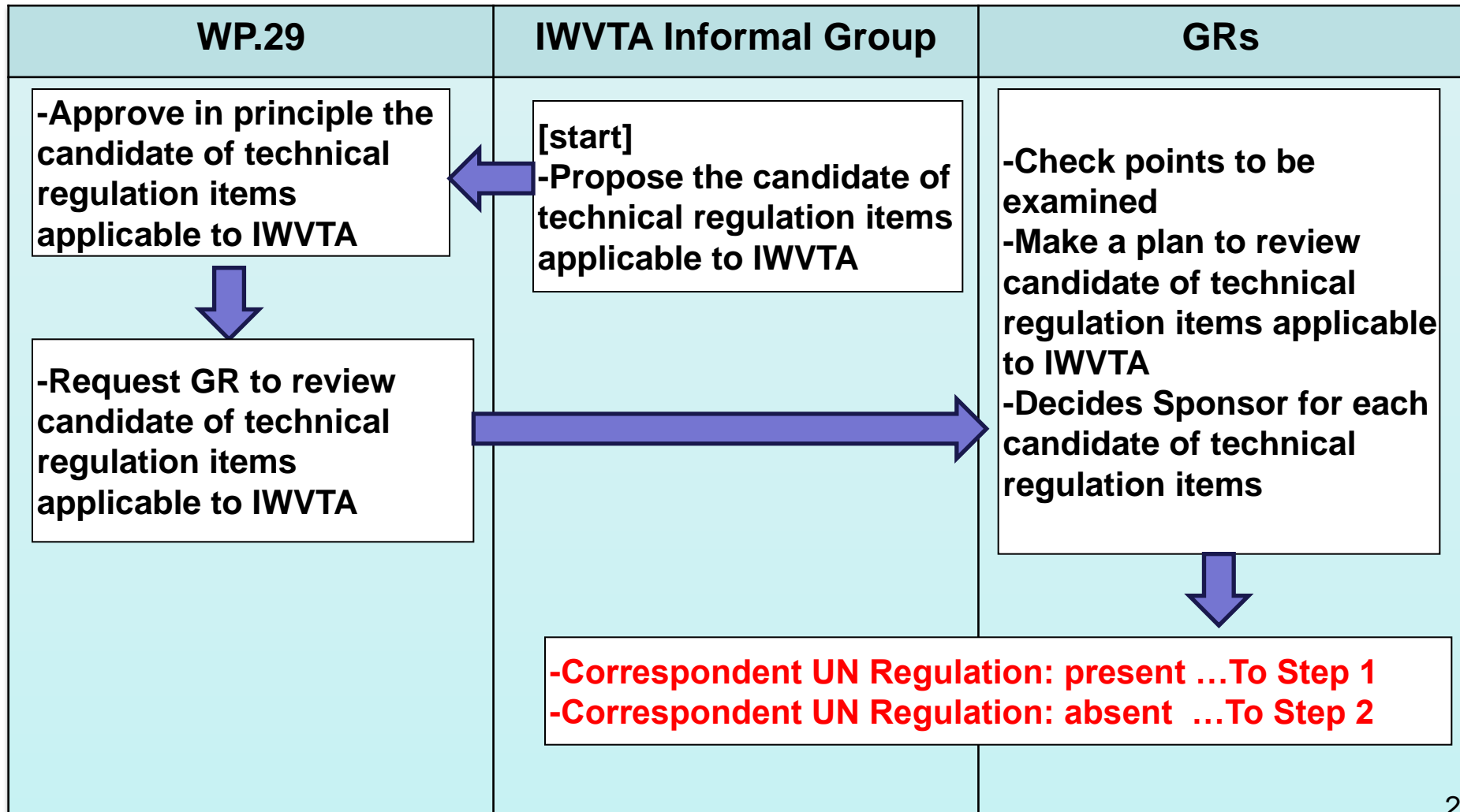

Step 1

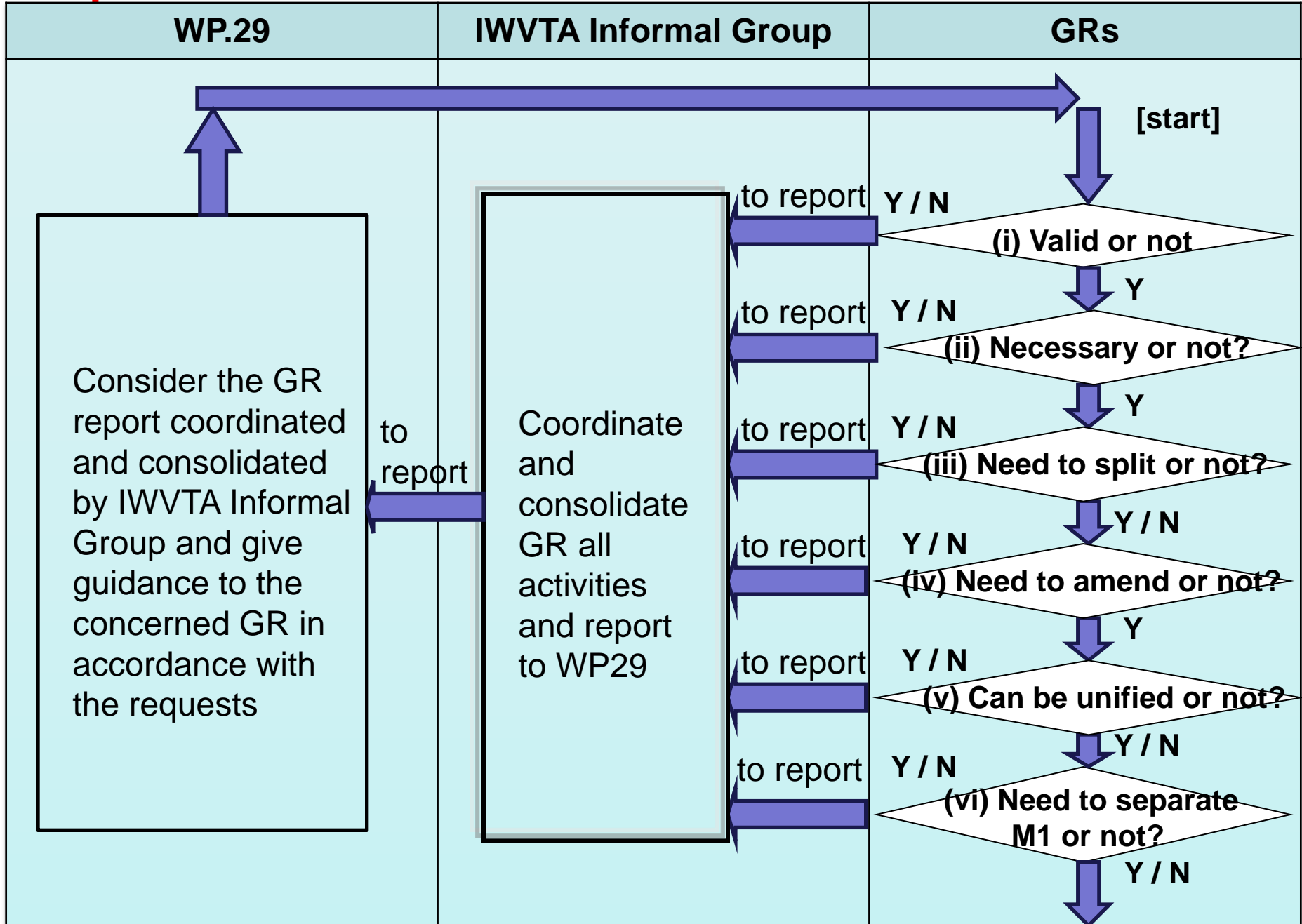

Step 1

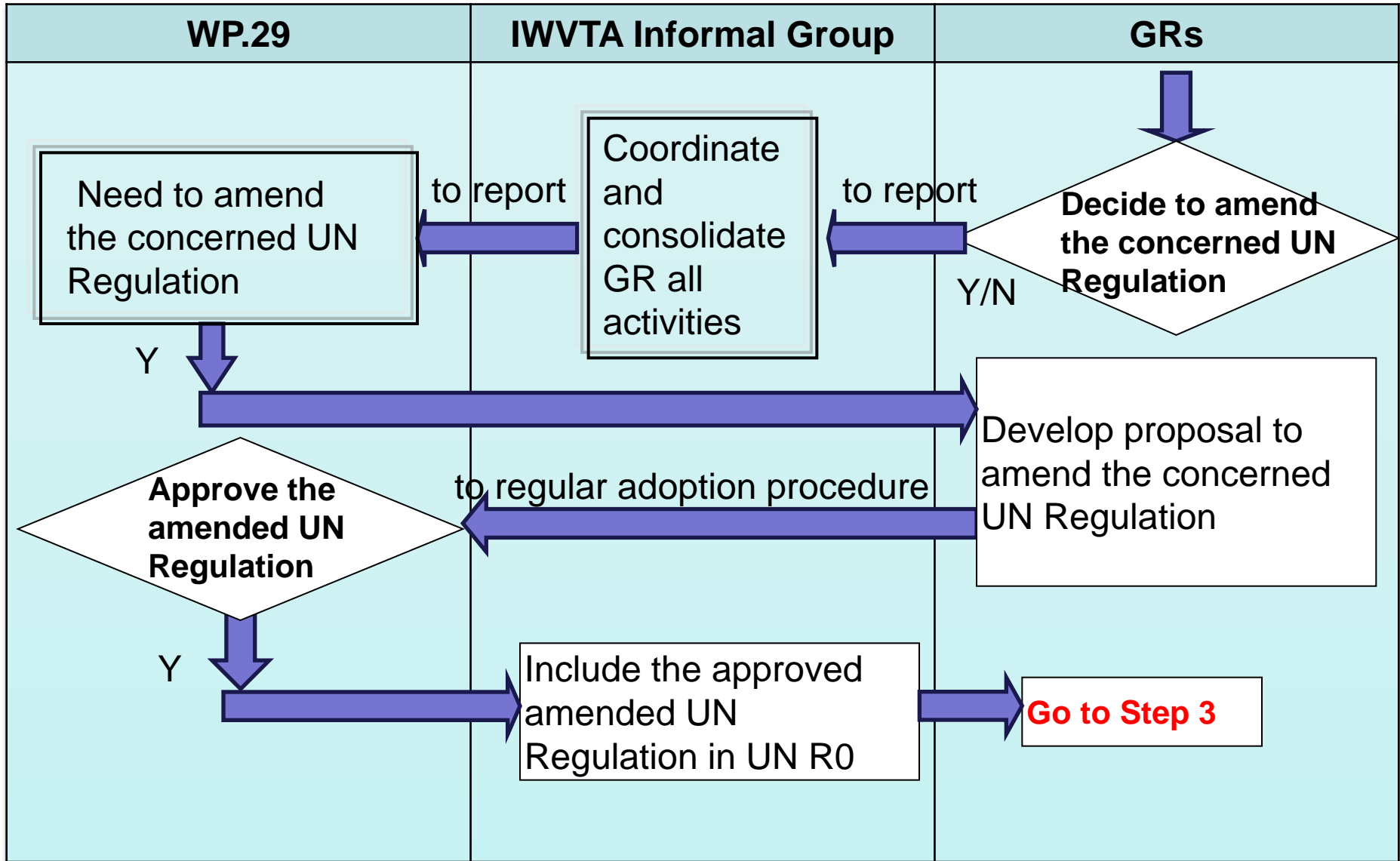

Step 2

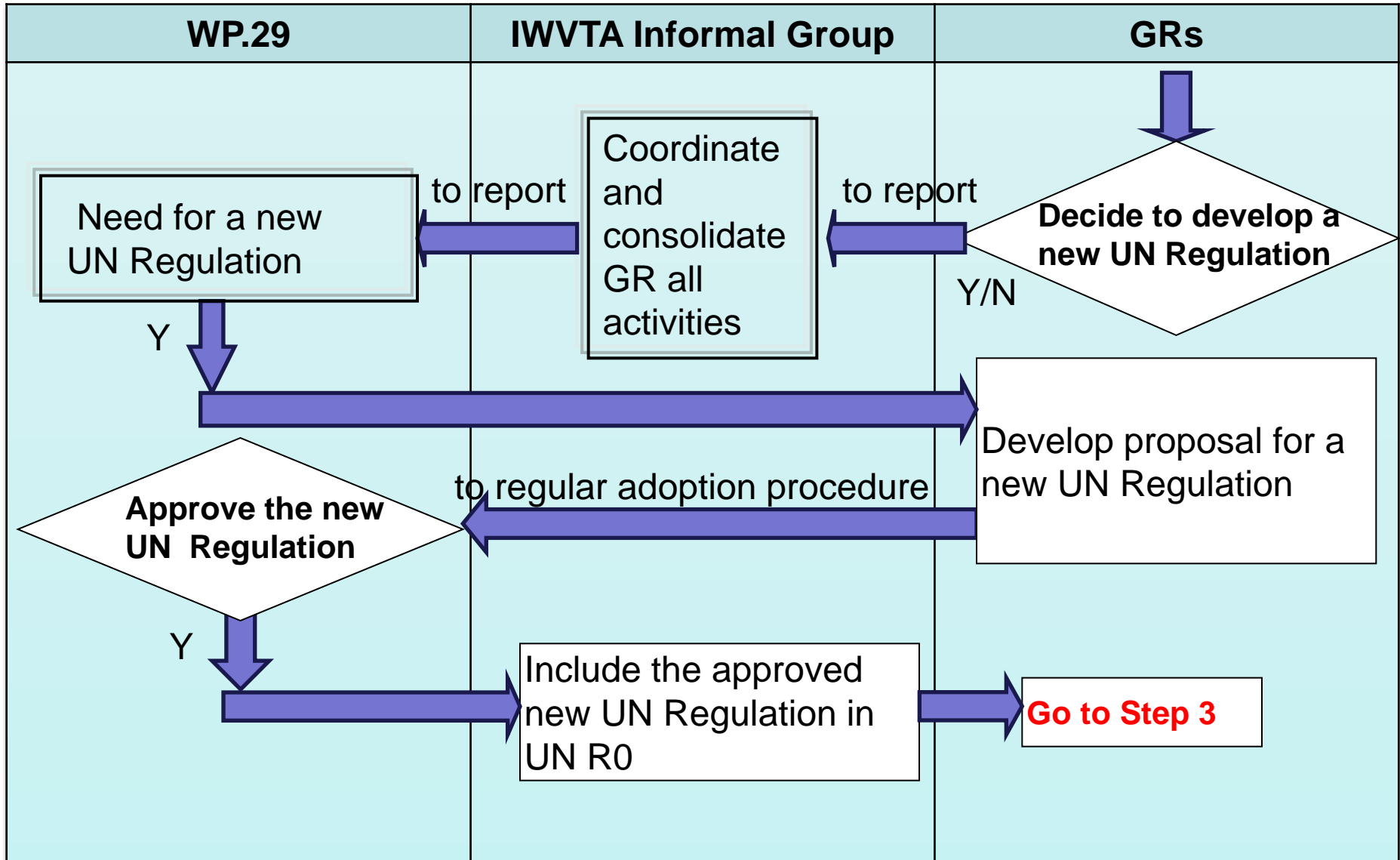

Step 3

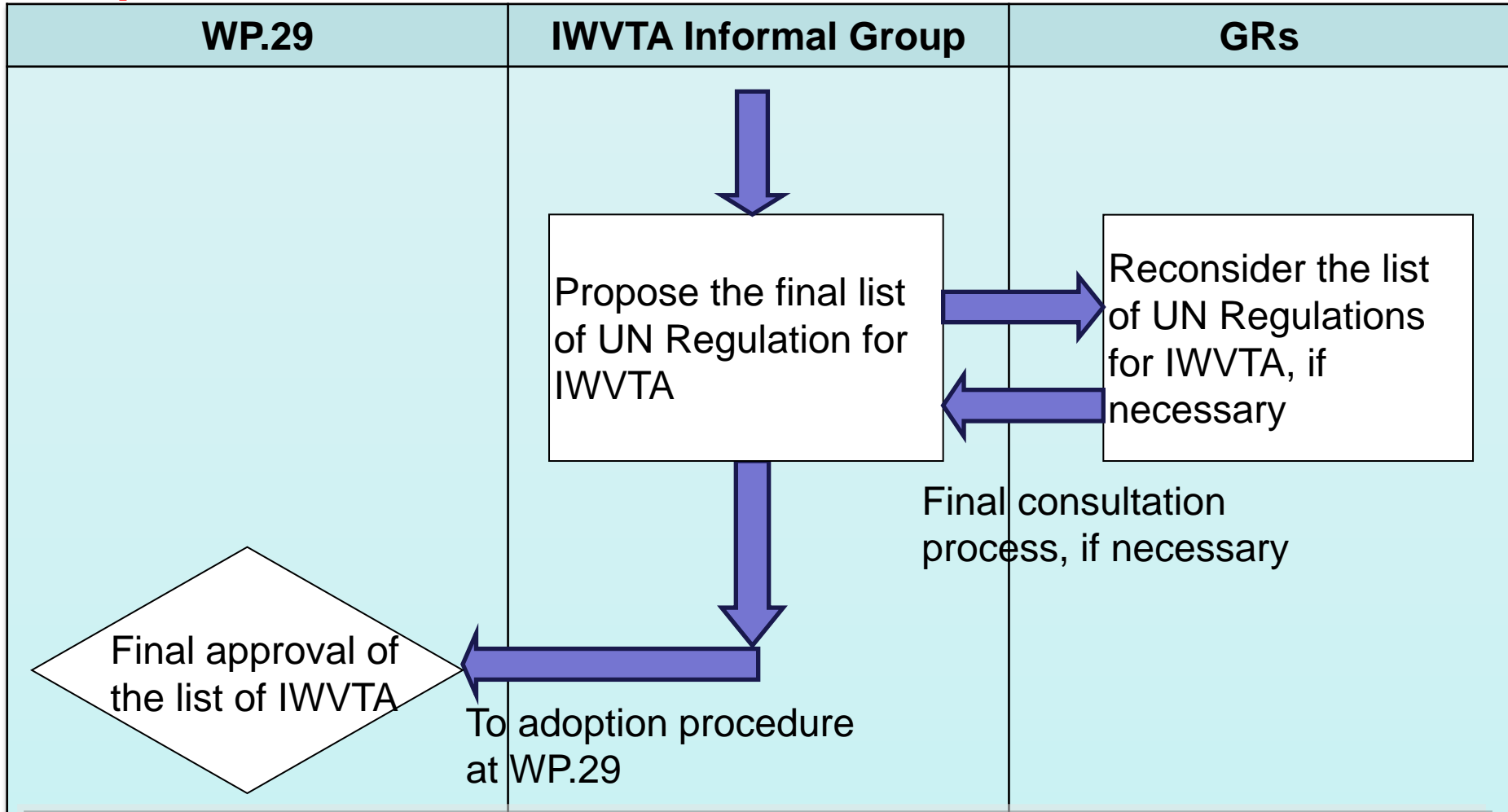

Interactive process among WP.29, GRs and IWVTA Informal Group requires cooperative approach such as IWVTA Ambassador.