

## **Adopted amendments to ECE/TRANS/WP.29/GRSG/2011/11 - Proposal for amendments to Regulation No. 118 (Burning behaviour of materials)**

The changes to ECE/TRANS/WP.29/GRSG/2011/11 are shown in red characters.

### **I. Proposal**

*The list of contents*

*Item 6.1.1., renumber as item 11.*

*Insert new Appendix 1 to Annex 4*

*The text of the Regulation*

*Paragraph 1.3., amend to read:*

"1.3. Part II – Approval of a component with regard to its burning behaviour and/or its capability to repel fuel or lubricant installed in the **interior passenger** compartment, the engine compartment or any separate heating compartment."

*Paragraph 2.2., amend to read:*

"2.2. ~~"Passenger compartment"~~ means the space for occupants' accommodation including bar, kitchen, toilet, etc.), bounded by: **"Interior compartment" means any compartment intended for passengers, drivers and/or crew.**

**The interior compartment shall be bounded by:**

- (a) the roof;
- (b) the floor;
- (c) the side walls;
- (d) the doors;
- (e) the outside glazing;
- (f) the rear compartment bulkhead, or the plane of the rear seat;
- (g) back support.

~~— at the driver's side of the longitudinal vertical median plane of the vehicle, the vertical transversal plane through the driver's R point as defined in Regulation No. 17.~~

~~— at the opposite side of the longitudinal vertical median plane of the vehicle, the front bulkhead."~~

*Insert new paragraph 2.9., to read:*

"2.9. **"Material installed in a vertical position"** means materials installed in the interior compartment, the engine compartment and any separate heating compartment of the vehicle such that its slope exceeds 15 per cent from the horizontal when the vehicle is at its mass in running order and it is standing on a smooth and horizontal ground surface."

*The whole section 4., amend to read:*

## **"4. Approval**

- 4.1.** If the type submitted for approval to this Regulation meets the requirements of the relevant part(s) of this Regulation, approval of that type shall be granted.
- 4.2.** An approval number shall be assigned to each type approved. Its first two digits (at present 02 corresponding to the 02 series of amendments) shall indicate the series of amendments incorporating the most recent major technical amendments made to the Regulation at the time of issue of the approval. The same Contracting Party shall not assign the same number to another type of vehicle or component as defined in this Regulation.
- 4.3.** Notice of approval or of extension of approval of a type pursuant to this Regulation shall be communicated to the Contracting Parties to the Agreement applying this Regulation, by means of one of the forms conforming to the models in Annexes 3 or 4, as appropriate, to this Regulation.
- 4.4.** There shall be affixed, conspicuously and in a readily accessible location specified on the approval form, to every vehicle conforming to a type approved under this Regulation, an international approval mark consisting of:
- 4.4.1.** a circle surrounding the letter "E" followed by the distinguishing number of the country which has granted approval; 2/
- 4.4.2.** the number of this Regulation, followed by the letter "R", "I" to indicate Part I of this Regulation, a dash and the approval number, to the right of the circle prescribed in paragraph 4.4.1.
- 4.4.3.** If the vehicle conforms to a vehicle type approved, under one or more other Regulations annexed to the Agreement, in the country which has granted approval under this Regulation, the symbol prescribed in paragraph 4.4.1. need not be repeated; in such a case, the Regulations under which approval has been granted in the country which has granted approval under this Regulation shall be placed in vertical columns to the right of the symbol prescribed in paragraph 4.4.1.
- 4.4.4.** The approval mark shall be clearly legible and be indelible.
- 4.4.5.** The approval mark shall be placed close to or on the vehicle data plate affixed by the manufacturer.
- 4.5.** Production materials do not need to be individually marked. However, the packaging with which they are supplied must be marked with an international approval mark consisting of:
- 4.5.1.** A circle surrounding the letter "E" followed by the distinguishing number of the country which has granted approval; 2/
- 4.5.2.** the number of this Regulation, followed by the letter "R", a "II" to indicate Part II of this Regulation, a dash and the approval number, to the right of the circle prescribed in paragraph 4.4.1.
- 4.5.3.** In the vicinity of the circle:
- 4.5.3.1.** Symbols indicating the direction which the material may be installed:
- ↔ for the horizontal direction (see para. 6.2.1.),
- ↑ for the vertical direction (see para. 6.2.3 and 6.2.4.),
-  for the horizontal and vertical directions (see paras. 6.2.1, 6.2.3. and 6.2.4.);

- 4.5.3.2. The symbol "V" indicating that the material fulfils the requirements in paragraph 6.2.2.
- 4.5.4. The approval mark shall be clearly legible and be indelible.
- 4.6. Components may be marked with the approval mark prescribed in paragraphs 4.5.
- 4.6.1. If marked, the marking of complete components such as seats, separation walls, luggage racks, etc, shall include the symbol "CD" indicating that the component has been approved as a complete device.
- 4.7. Annex 5 to this Regulation gives examples of arrangements of approval marks."

*Paragraphs 5.2.1. to 5.2.3., amend to read:*

- "5.2.1. The materials of the **interior passenger** compartment, the engine compartment and any separate heating compartment used in the vehicle to be type approved shall meet the requirements of Part II of this Regulation.
- 5.2.2. The materials and/or equipment used in the **interior passenger** compartment, the engine compartment and any separate heating compartment and/or in devices approved as components shall be so installed as to minimize the risk of flame development and flame propagation.
- 5.2.3. Such materials and/or equipment shall only be installed in accordance with their intended purposes and the test(s) which they have undergone (see paragraphs 6.2.1., 6.2.2., 6.2.3., 6.2.4., 6.2.5., 6.2.6. **and 6.2.7.**), especially in relation to their burning and melting behaviour (horizontal/vertical direction) and/or their capability to repel fuel or lubricant."

*Paragraph 6.1.4., amend to read:*

- "6.1.4. "*Exposed face*" means the side of a material which is facing towards the **interior passenger** compartment, the engine compartment and any separate heating compartment when the material is mounted in the vehicle."

*Paragraphs 6.2.1. to 6.2.3., amend to read:*

- "6.2.1. The following materials shall undergo the test described in Annex 6 to this Regulation:
  - (a) ~~material(s) used for the upholstery of any seat and its accessories (including the driver's seat),~~
  - (b) ~~material(s) used for the interior lining of the roof,~~
  - (c) ~~material(s) used for the interior lining of the side and rear walls, including separation walls,~~
  - (d) ~~material(s) with thermal and/or acoustic function,~~
  - (e) ~~material(s) used for the interior lining of the floor,~~
  - (f) ~~material(s) used for the interior lining of luggage racks, heating and ventilation pipes,~~
  - (g) ~~material(s) used for the light fittings~~
  - (a) **material(s) and composite material(s) installed in a horizontal position in the interior compartment and,**
  - (b) **insulation material(s) installed in a horizontal position in the engine compartment and any separate heating compartment.**

The result of the test shall be considered satisfactory if, taking the worst test results into account, the horizontal burning rate is not more than 100 mm/minute or if the flame extinguishes before reaching the last measuring point.

**Materials fulfilling the requirements in 6.2.3. are considered to fulfil the requirements in this paragraph.**

6.2.2. The following materials shall undergo the test described in Annex 7 to this Regulation:

- ~~(a) material(s) used for the interior lining of the roof,~~
- ~~(b) material(s) used for the interior lining of the luggage racks, heating and ventilation pipes situated in the roof,~~
- ~~(c) material(s) used for the lights situated in the luggage racks and/or roof.~~
- (a) material(s) and composite material(s) installed more than 500 mm above the seat cushion and in the roof of the vehicle,**
- (b) insulation material(s) installed in the engine compartment and any separate heating compartment.**

The result of the test shall be considered satisfactory if, taking the worst test results into account, no drop is formed which ignites the cotton wool.

6.2.3. ~~The materials used for the curtains and blinds (and/or other hanging materials) shall undergo the test described in Annex 8.~~**The following materials shall undergo the test described in Annex 8 to this Regulation:**

- (a) material(s) and composite material(s) installed in a vertical position in the interior compartment,**
- (b) insulation material(s) installed in a vertical position in the engine compartment and any separate heating compartment.**

The result of the test shall be considered satisfactory if, taking the worst test results into account, the vertical burning rate is not more than 100 mm/minute **or if the flame extinguishes before the destruction of one of the first marker threads occurred."**

*Insert a new paragraph 6.2.4. (including new footnote 3), to read:*

**"6.2.4. ~~At the request of the manufacturer, testing according to ISO 5658-2<sup>3</sup>, may replace testing according to Annexes 7 and 8. Materials achieving an average CFE (critical heat flux at extinguishment) value greater or equal to 20 kW/m<sup>2</sup>, when tested according to ISO 5658-2<sup>3</sup>, are deemed to comply with the requirements of paragraphs 6.2.2. and 6.2.3., provided no burning drops are observed when taking the worst test results into account."~~**

**~~The result of the test shall be considered satisfactory if the average value of CFE is greater or equal to 20 kW/m<sup>2</sup> and if, taking the worst test results into account, no burning drops are observed."~~**

---

<sup>3</sup> ISO 5658-2:2006 Reaction to fire tests – spread of flame – Part 2: Lateral spread on building and transport products in vertical configuration.

*Paragraphs 6.2.4. (former) to 6.2.6.3.1., renumber as paragraphs 6.2.5. to 6.2.7.3.1.*

Paragraphs 6.2.6.3.2.(former) and 6.2.6.4., renumber as paragraphs 6.2.7.3.2. and 6.2.7.4. and amend to read:

- "6.2.7.3.2. 300 cm<sup>2</sup> or 120 cm<sup>3</sup> per seat row and, at a maximum, per linear metre of the interior of the **interior passenger** compartment for these elements which are distributed in the vehicle and which are not connected to an individual seating place;
- 6.2.7.4. elements for which it is not possible to extract a sample in the prescribed dimensions as specified in paragraph 3.1. of Annex 6 **and** paragraph 3. of Annex 7, ~~and paragraph 3.1. of Annex 8.~~"

*Insert new paragraphs 12.6. to 12.10., to read:*

- "12.6. As from the official date of entry into force of the 02 series of amendments, no Contracting Party applying this Regulation shall refuse to grant ECE approval under this Regulation as amended by the 02 series of amendment.**
- 12.7. As from 48 months after the official date of entry into force of the 02 series of amendments, Contracting Party applying this Regulation shall grant ECE approvals only if the component type to be approved meet the requirements of this Regulation as amended by the 02 series of amendments.**
- 12.8. As from 60 months after the official date of entry into force of the 02 series of amendments, Contracting Party applying this Regulation shall grant ECE approvals only if the vehicle type to be approved meet the requirements of this Regulation as amended by the 02 series of amendments.**
- 12.9. Starting 96 months after the official date of entry into force of the 02 series of amendments, Contracting Party applying this Regulation may refuse first national registration (first entry into service) of a vehicle which does not meet the requirements of this Regulation as amended by the 02 series of amendments.**
- 12.10. Even after the date of entry into force of the 02 series of amendments, approvals of the components to the preceding series of amendments to the regulation shall remain valid and Contracting Parties applying the Regulation shall continue to accept them."**

Annex 1, amend to read:

## "Annex 1

### Information document

(in accordance with paragraph 3.2. of this Regulation relating to the ECE Type Approval of a vehicle with regard to the burning behaviour of the components used in the **interior passenger** compartment, the engine compartment and any separate heating compartment-and/or the capability to repel fuel or lubricant of insulation materials used in the engine compartment and any separate heating compartment)

~~If the systems, components or separate technical units have electronic controls, information concerning their performance must be supplied~~

1. General
  - 1.1. Make (trade name of manufacturer): .....
  - 1.2. Type and general commercial description(s): .....
  - 1.3. Means of identification of type, if marked on the vehicle: .....
  - 1.4. Location of that marking: .....
  - 1.5. Category of vehicle: <sup>1</sup> .....
  - 1.6. Name and address of manufacturer: .....
  - 1.7. Address(es) of assembly plant(s): .....
2. General construction characteristics of the vehicle
  - 2.1. Photographs and/or drawings of a representative vehicle:
3. Bodywork  
Interior fittings and/or insulation materials
  - 3.1. Seats
    - 3.1.1. Number: .....
  - ~~3.2. Burning behaviour of materials used in the interior construction of the vehicle~~
    - ~~3.2.1. Material(s) used for the interior lining of the roof~~
      - ~~3.2.1.1. Component type approval number(s): .....~~
    - ~~3.2.2. Material(s) used for the rear and side walls~~
      - ~~3.2.2.1. Component type approval number(s): .....~~
    - ~~3.2.3. Material(s) used for the floor~~
      - ~~3.2.3.1. Component type approval number(s): .....~~
    - ~~3.2.4. Material(s) used for the upholstery of the seats~~
      - ~~3.2.4.1. Component type approval number(s): .....~~
    - ~~3.2.5. Material(s) used for heating and ventilation pipes~~
      - ~~3.2.5.1. Component type approval number(s): .....~~
    - ~~3.2.6. Material(s) used for luggage racks~~
      - ~~3.2.6.1. Component type approval number(s): .....~~
    - ~~3.2.7. Material(s) used for other purposes~~
      - ~~3.2.7.1. Intended purposes: .....~~
      - ~~3.2.7.2. Component type approval number(s): .....~~
    - ~~3.2.8. Components approved as complete devices (seats, separation walls, luggage racks, etc.)~~
      - ~~3.2.8.1. Component type approval number(s): .....~~

- ~~3.3. Capability of materials to repel fuel or lubricant used in the vehicle~~
- ~~3.3.1. Material(s) used for insulation purposes~~
- ~~3.3.1.1. Component type approval number(s): .....~~
- ~~3.4. Electric cables~~
- ~~3.4.1. Component type approval number(s): .....~~
- 3.2. Material(s) used in the interior compartment, stating for each material**
- 3.2.1. Component type-approval number, if available: .....**
- 3.2.2. Make: .....**
- 3.2.3. Type designation: .....**
- 3.2.4. Tested according to paragraphs 6.2.1, 6.2.2., 6.2.3., 6.2.4.<sup>2</sup>: .....**
- 3.2.5. For materials not approved**
- 3.2.5.1. Base material(s)/designation: . . . / . . . .....**
- 3.2.5.2. Composite/single <sup>2</sup> material, number of layers <sup>2</sup>: .....**
- 3.2.5.3. Type of coating <sup>2</sup>: .....**
- 3.2.5.4. Maximum/minimum thickness ..... mm**
- 3.3. Materials used for insulation in the engine compartment and/or separate heating compartment, stating for each material**
- 3.3.1. Component type-approval number, if available: .....**
- 3.3.2. Make: .....**
- 3.3.3. Type designation: .....**
- 3.3.4. Tested according to 6.2.1., 6.2.2., 6.2.3, 6.2.4., 6.2.5. <sup>2</sup>: .....**
- 3.3.5. For materials not approved**
- 3.3.5.1. Base material(s)/designation: . . . / . . . .....**
- 3.3.5.2. Composite/single <sup>2</sup> material, number of layers <sup>2</sup>: .....**
- 3.3.5.3. Type of coating <sup>2</sup>: .....**
- 3.3.5.4. Maximum/minimum thickness ..... mm**
- 3.4. Electric cables, stating for each type**
- 3.4.1. Component type-approval number(s) if available: .....**
- 3.4.2. Make: .....**
- 3.4.3. Type designation: .....**
- 3.4.5. For materials not approved**
- 3.4.5.1. Base material(s)/designation: . . . / . . . .....**
- 3.4.5.2. Composite/single <sup>2</sup> material, number of layers <sup>2</sup>: .....**
- 3.4.5.3. Type of coating <sup>2</sup>: .....**
- 3.4.5.4. Maximum/minimum thickness ..... mm**

<sup>1</sup> As defined in the Consolidated Resolution on the Constuction of Vehicles (R.E.3), Annex 7 (document TRANS/WP.29/78/Rev.1/Amend.2).

<sup>2</sup> Strike out what does not apply. "

*Annex 2*, amend to read:

## "Annex 2

### Information document

(in accordance with paragraph 3.2. of the Regulation relating to the ECE Type Approval of a component used in the **interior passenger** compartment, the engine compartment and any separate heating compartment with regard to its burning behaviour and/or the capability to repel fuel or lubricant of insulation materials used in the engine compartment and any separate heating compartment)

~~If the systems, components or separate technical units have electronic controls, information concerning their performance must be supplied~~

1. General
  - 1.1. Make (trade name of manufacturer): .....
  - 1.2. Type and general commercial description(s): .....
  - 1.3. Name and address of manufacturer: .....
  - 1.4. In the case of components and separate technical units, location and method of affixing of the ECE approval mark: .....
  - 1.5. Address(es) of assembly plant(s): .....
2. Interior materials
  - 2.1. ~~Material(s) used for~~ **intended for horizontal / vertical / horizontal and vertical installation<sup>2</sup>**  
**Material intended to be installed more than 500 mm above the seat cushion and/or in the roof of the vehicle: yes / not applicable<sup>2</sup>**
  - 2.2. Base material(s)/designation: . . . / . . . .....
  - 2.3. Composite/single<sup>1</sup> material, number of layers<sup>1</sup>: .....
  - 2.4. Type of coating<sup>1</sup>: .....
  - 2.5. Maximum/minimum thickness ..... mm
  - 2.6. Type-approval number, if available: .....
3. Insulation materials
  - 3.1. ~~Material(s) used for~~ **intended for horizontal / vertical / horizontal and vertical installation<sup>2</sup>**
  - 3.2. Base material(s)/designation: . . . / . . . .....
  - 3.3. Composite/single<sup>1</sup> material, number of layers<sup>1</sup>: .....
  - 3.4. Type of coating<sup>1</sup>: .....
  - 3.5. Maximum/minimum thickness ..... mm
  - 3.6. Type-approval number, if available: .....
4. Electric cables
  - 4.1. Material(s) used for: .....
  - 4.2. Base material(s)/designation: . . . / . . . .....
  - 4.3. Composite/single<sup>1</sup> material, number of layers<sup>1</sup>: .....
  - 4.4. Type of coating<sup>1</sup>: .....
  - 4.5. Maximum/minimum thickness ..... mm
  - 4.6. Type-approval number, if available: .....

<sup>1</sup> Delete where not applicable

<sup>2</sup> **Strike out what does not apply. "**



*Annex 4*

*Section II, paragraph 1., amend to read:*

"1. Additional information (where applicable): **see Appendix 1**"

*Annex 4, insert new Appendix 1:*

**"Annex 4**

**Appendix 1**

**Appendix 1 to type-approval communication form No. ....  
concerning the type-approval of a component type pursuant to  
Regulation No. 118**

- 1. Additional information.
  - 1.1. Interior materials
    - 1.1.1. The direction which the component may be installed: horizontal / vertical / both horizontal and vertical direction(s).<sup>2</sup>
    - 1.1.2. Fulfils the requirements in paragraph 6.6.2: yes / not applicable<sup>2</sup>
    - 1.1.3. Compliance has been checked for components approved as complete devices: yes / no<sup>2</sup>
    - 1.1.4. Any restrictions of use and installation requirements: .....
  - 1.2. Insulation materials
    - 1.2.1. The direction which the component may be installed: horizontal / vertical / both horizontal and vertical direction(s).<sup>2</sup>
    - 1.2.2. Compliance has been checked for components approved as complete devices: yes / no<sup>2</sup>
    - 1.2.3. Any restrictions of use and installation requirements: .....
  - 1.3. Electric cables
    - 1.3.1. Any restrictions of use and installation requirements: .....
- 5. Remarks: ....."

Annex 5, amend to read:

**"Annex 5**

**Arrangements of approval marks**

**Example 1**

(see Part I of this Regulation)

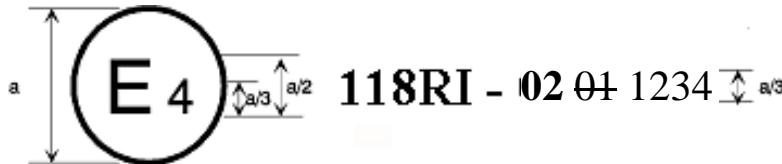

a = 8 mm min

The above approval mark affixed to a vehicle shows that the type concerned was approved in the Netherlands (E4) pursuant to Part I of Regulation No. 118 under approval No. 01 021234. The first two digits (01 02) of the approval number indicate that the approval was granted in accordance with the requirements of the 01 02 series of amendments to Regulation No. 118.

**Example 2**

(see part II of this Regulation)

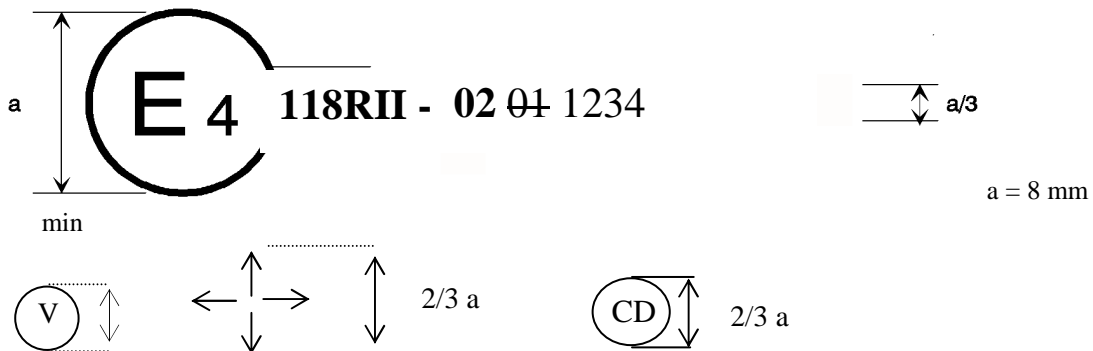

a = 8 mm

The above approval mark affixed to a component shows that the type concerned was approved in the Netherlands (E4) pursuant to Part II of Regulation No. 118 under approval number 01 021234. The first two digits (01 02) of the approval number indicate that the approval was granted in accordance with the requirements of the 01 02 series of amendments to Regulation No. 118.

The additional symbol  indicates that this type of component the direction which the component may be installed has been approved according to its horizontal and vertical burning rate.

The symbol  indicates that the component fulfils the requirements in paragraph 6.2.2.

The symbol  indicates an approval as a complete device such as seats, separation walls, etc..

The additional symbols are only used if applicable."

Annex 6, Paragraphs 1.2., amend to read:

"1.2. The samples shall be taken from the material under test. In materials having different burning rates in different material directions, each direction has to be tested. The samples are to be taken and placed in the test apparatus so that the highest burning rate will be measured. When the material is supplied in widths, a length of at least 500 mm shall be cut covering the entire width. From this the samples shall be taken so as to be

at least 100 mm from the material edge and equidistant from each other. Samples shall be taken in the same way from finished products, when the shape of the product permits. When the thickness of the product is more than 13 mm, it shall be reduced to 13 mm by a mechanical process applied to the side which does not face the **respective occupant compartment (interior, engine or separate heating compartment)**. If it is impossible, the test shall be carried out, in accordance with the Technical Service, on the initial thickness of the material, which shall be mentioned in the test report.

Composite materials (see paragraph 6.1.3.) shall be tested as if they were of uniform construction. In the case of materials made of superimposed layers of different composition which are not composite materials, all the layers of material included within a depth of 13 mm from the surface facing towards the **respective passenger compartment** shall be tested individually."

*Annex 7, Paragraphs 3., amend to read:*

"3. Samples

The test samples shall measure: 70 mm x 70 mm. Samples shall be taken in the same way from finished products, when the shape of the product permits. When the thickness of the product is more than 13 mm, it shall be reduced to 13 mm by a mechanical process applied to the side which does not face the **respective occupant compartment (interior, engine or separate heating compartment)**. If it is impossible, the test shall be carried out, in accordance with the Technical Service, on the initial width of the material which shall be mentioned in the test report.

Composite materials (see paragraph 6.1.3. of the Regulation) shall be tested as if they were of uniform construction.

In the case of materials made of superimposed layers of different composition which are not composite materials, all the layers of material included within a depth of 13 mm from the surface facing towards the respective passenger compartment (interior, engine or separate heating compartment) shall be tested individually.

The total mass of the sample to be tested shall be at least 2 g. If the mass of one sample is less, a sufficient number of samples shall be added.

If the two faces of the material differ, both faces must be tested, which means that eight samples are to be tested. The samples and the cotton wool shall be conditioned for at least 24 hours at a temperature  $23^{\circ} \text{C} \pm 2^{\circ} \text{C}$  and a relative humidity of  $50 \pm 5$  per cent and shall be maintained under these conditions until immediately prior to testing."

*Annex 8, paragraph 3.1., amend to read:*

"3.1. The samples dimensions are: 560 x 170 mm.

**If the dimensions of a material do not permit taking a sample of the given dimensions the test shall be carried out, in accordance with the Technical Service, on the fitted size of the material which shall be mentioned in the test report."**

*Annex 8, insert new paragraph 3.2., to read:*

"3.2. **When the thickness of the sample is more than 13 mm, it shall be reduced to 13 mm by a mechanical process applied to the side which does not face the respective compartment (interior, engine or separate heating compartment). If it is impossible, the test shall be carried out in accordance with the Technical Service the initial thickness of the material, which shall be mentioned in the test report. Composite materials (see paragraph 6.1.3.) shall be tested as if they were of uniform construction. In the case of materials made of**

**superimposed layers of different composition which are not composite materials, all the layers of material included within a depth of 13 mm from the surface facing towards the respective compartment shall be tested individually."**

*Annex 8, paragraph 3.2.(former), renumber as paragraph 3.3.*

*Annex 8, paragraphs 4.3. and 4.4., amend to read:*

"4.3. The specimen shall be placed (**after the reward marker threads have been located**) on the pins of the test frame, making certain that the pins pass through the points marked off from the template and that the specimen is at least 20 mm removed from the frame. The frame shall be fitted on the support so that the specimen is vertical.

4.4. The marker threads shall be attached horizontally in front **of and behind** of the specimen at the locations shown in figure 1. At each location, a loop of thread shall be mounted so that the two segments are spaced 1 mm and 5 mm from the **front and rearface** ~~plane of the front~~ of the specimen.

Each loop shall be attached to a suitable timing device. Sufficient tension shall be imposed to the threads to maintain ~~its~~ **their** position relative to the specimen."

*Annex 8, paragraph 4.7., amend to read:*

"4.7. The following times, in seconds, shall be measured:

- (a) from the start of the application of the igniting flame to the severance **of one** of the first marker threads ( $t_1$ );
- (b) from the start of the application of the igniting flame to the severance **of one** the second marker threads ( $t_2$ );
- (c) from the start of the application of the igniting flame to the severance **of one** the third marker threads ( $t_3$ )."

*Annex 8, insert new paragraphs 4.8. and 4.9, to read:*

"4.8. **If the sample does not ignite or does not continue burning after the burner has been extinguished or if the flame extinguishes before the destruction of one of the first marker threads occurred, so that no burning time is measured, the burning rate is considered to be 0 mm/min.**

4.9. **If the sample does ignite and the flames of the burning sample do reach the height of the third marker threads without destroying the first and second marker threads (e.g. due to material characteristics of thin material sample), the burning rate is considered to be more than 100 mm/min."**

*Annex 8, paragraph 5., amend to read:*

"5. Results

The observed phenomena shall be written down in the test-report, to include:

- (i) the durations of combustion:  $t_1$ ,  $t_2$  and  $t_3$  in seconds, and
- (ii) the corresponding burnt distances:  $d_1$ ,  $d_2$  and  $d_3$  in mm.

The burning rate  $V_1$  and the rates  $V_2$  and  $V_3$ , if applicable, shall be calculated (for each sample if the flame reaches at least **one of** the first marker threads) as follows:

$$V_i = 60 d_i/t_i \text{ (mm/min)}$$

The highest burning rate of  $V_1$ ,  $V_2$  and  $V_3$  shall be taken into account."

Annex 8, figure 1, amend to read:

Figure 1

**Specimen holder (Dimensions in millimetres)**

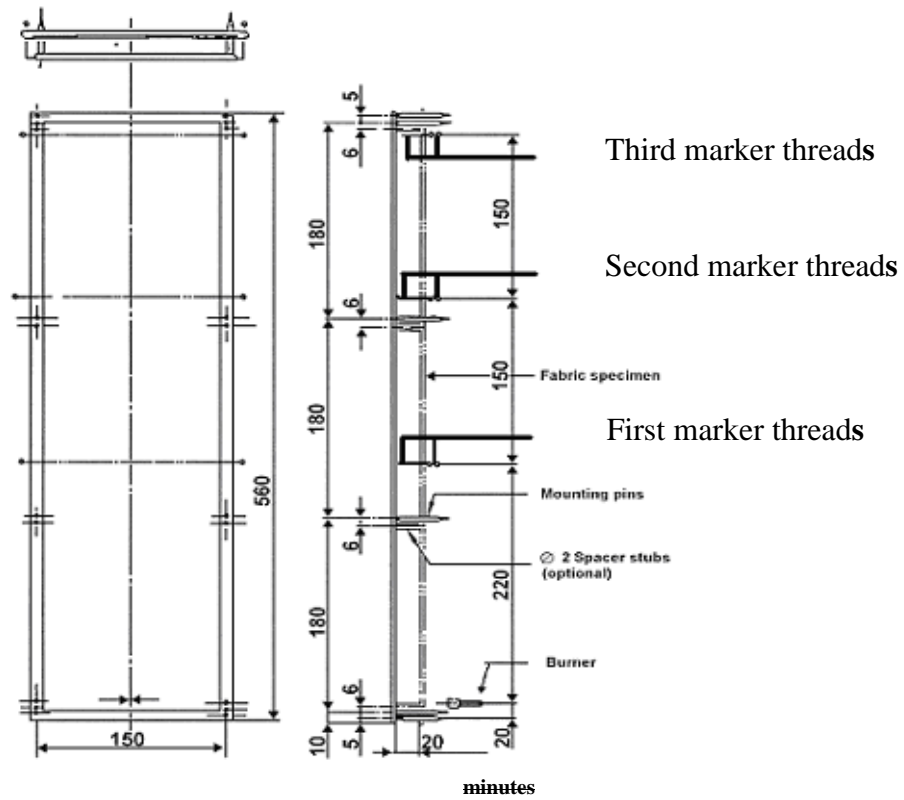

minutes

Annex 8, figure 2, amend to read:

Figure 2

**Burner ignition location (Dimensions in millimetres)**

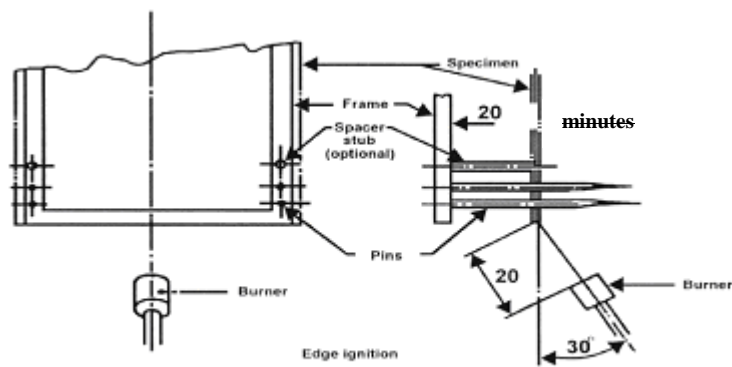

minutes