

**PROPOSAL FOR THE DRAFT 03 SERIES OF AMENDMENTS TO  
REGULATION No. 10**

**A. PROPOSAL**

Paragraph 1., amend to read:

"1. SCOPE

This Regulation applies to:

- 1.1. vehicles of categories L, M, N and O, and to
  - 1.2. components and separate technical units intended to be fitted in these vehicles with the limitation given in paragraph 3.2.1.
- with regard to electromagnetic compatibility.

It covers:

- (a) requirements regarding the immunity to radiated and conducted disturbances for functions related to direct control of the vehicle, related to driver, passenger and other road users' protection and related to disturbances, which would cause confusion to the driver or other road users;
- (b) requirements regarding the control of unwanted radiated and conducted emissions to protect the intended use of electrical or electronic equipment at own or adjacent vehicles or nearby, and the control of disturbances from accessories that may be retrofitted to the vehicle."

Paragraph 2., amend to read:

"2. DEFINITIONS

For the purposes of this Regulation:

- 2.1. "Electromagnetic compatibility" means the ability of a vehicle or component(s) or separate technical unit(s) to function satisfactorily in its electromagnetic environment without introducing intolerable electromagnetic disturbances to anything in that environment.
- 2.2. "Electromagnetic disturbance" means any electromagnetic phenomenon which may degrade the performance of a vehicle or component(s) or separate technical unit(s), or of any other device, unit of equipment or system operated in vicinity of a vehicle. An electromagnetic disturbance may be electromagnetic noise, an unwanted signal or a change in the propagation medium itself.

- 2.3. "**Electromagnetic immunity**" means the ability of a vehicle or component(s) or separate technical unit(s) to operate without degradation of performance in the presence of (specified) electromagnetic disturbances which includes wanted radio frequency signals from radio transmitters or radiated in-band emissions of Industrial-Scientific-Medical (ISM) apparatus, internal or external to the vehicle.
- 2.4. "**Electromagnetic environment**" means the totality of electromagnetic phenomena existing at a given location.
- 2.5. "**Broadband emission**" means an emission, which has a bandwidth greater than that of a particular measuring apparatus or receiver (International Special Committee on Radio Interference (CISPR) 25, second edition).
- 2.6. "**Narrowband emission**" means an emission which has a bandwidth less than that of a particular measuring apparatus or receiver (CISPR 25, second edition).
- 2.7. "**Electrical/electronic system**" means (an) electrical and/or electronic device(s) or set(s) of devices together with any associated electrical connections which form part of a vehicle but which are not intended to be type approved separately from the vehicle.
- 2.8. "**Electrical/electronic sub-assembly**" (ESA) means an electrical and/or electronic device or set(s) of devices intended to be part of a vehicle, together with any associated electrical connections and wiring, which performs one or more specialised functions. An ESA may be approved at the request of a manufacturer or his authorised representative as either a "component" or a "separate technical unit (STU)".
- 2.9. "**Vehicle type**" in relation to electromagnetic compatibility includes all vehicles, which do not differ essentially in such respects as:
- 2.9.1. the overall size and shape of the engine compartment;
- 2.9.2. the general arrangement of the electrical and/or electronic components and the general wiring arrangement;
- 2.9.3. the primary material of which the body or shell of the vehicle is constructed (for example, a steel, aluminium or fibreglass body shell). The presence of panels of different material does not change the vehicle type provided the primary material of the body is unchanged. However, such variations must be notified.
- 2.10. An "**ESA type**" in relation to electromagnetic compatibility means ESAs, which do not differ in such essential respects as:
- 2.10.1. the function performed by the ESA;
- 2.10.2. the general arrangement of the electrical and/or electronic components, if applicable.

- 2.11. "**Vehicle wiring harness**" means supply voltage, bus system (e.g. CAN), signal or active antenna cables, which are installed by the vehicle manufacturer.
- 2.12. "**Immunity related functions**" are:
- (a) Functions related to the direct control of the vehicle:
    - (i) by degradation or change in: e.g. engine, gear, brake, suspension, active steering, speed limitation devices;
    - (ii) by affecting drivers position: e.g. seat or steering wheel positioning;
    - (iii) by affecting driver's visibility: e.g. dipped beam, windscreen wiper.
  - (b) Functions related to driver, passenger and other road user protection:
    - (i) e.g. airbag and safety restraint systems.
  - (c) Functions which when disturbed cause confusion to the driver or other road users:
    - (i) optical disturbances: incorrect operation of e.g. direction indicators, stop lamps, end outline marker lamps, rear position lamp, light bars for emergency system, wrong information from warning indicators, lamps or displays related to functions in subparagraphs (a) or (b) which might be observed in the direct view of the driver;
    - (ii) acoustical disturbances: incorrect operation of e.g. anti-theft alarm, horn.
  - (d) Functions related to vehicle data bus functionality:
    - (i) by blocking data transmission on vehicle data bus-systems, which are used to transmit data, required to ensure the correct functioning of other immunity related functions.
  - (e) Functions which when disturbed affect vehicle statutory data: e.g. tachograph, odometer."

Paragraph 3.1.3., amend to read:

"3.1.3. The vehicle manufacturer shall draw up a schedule describing **all relevant** vehicle electrical/electronic systems or ESAs, body **styles, variations** in body **material, general** wiring arrangements, engine variations, left-hand/right-hand drive versions and wheelbase versions. Relevant vehicle electrical/electronic systems or ESAs are those which may emit significant broadband or narrowband **radiation** and/or those which **are involved in immunity related functions** of the vehicle (see paragraph 2.12.)."

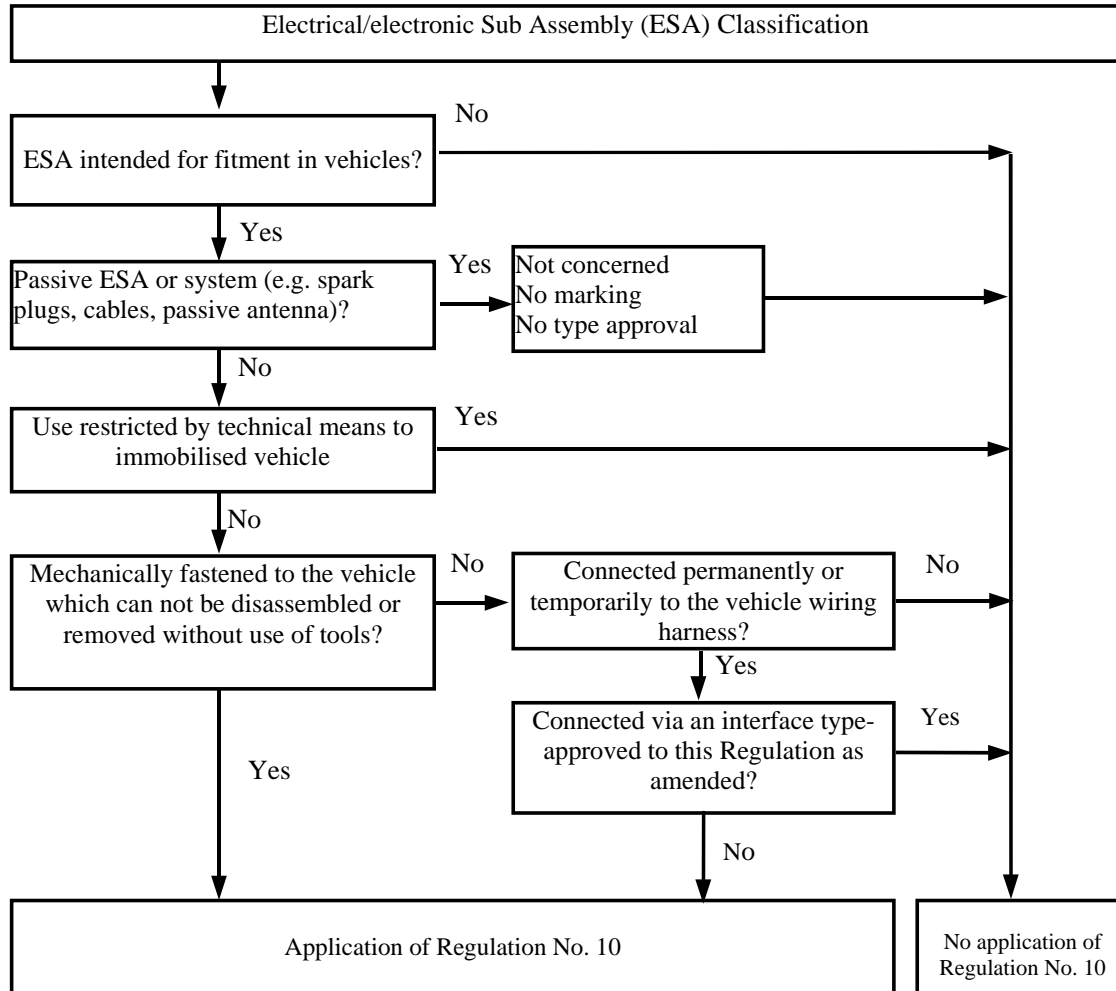
Insert a new paragraph 3.1.8., to read:

"3.1.8. For vehicles of categories M, N, and O the vehicle manufacturer must provide a statement of frequency bands, power levels, antenna positions and installation provisions for the installation of radio frequency transmitters (RF-transmitters), even if the vehicle is not equipped with an RF transmitter at time of type-approval. This should cover all mobile radio services normally used in vehicles. This information must be made publicly available following the type-approval.

**Vehicle manufacturers must provide evidence that vehicle performance is not adversely affected by such transmitter installations."**

Insert a new paragraph 3.2.1., to read:

**"3.2.1. Applicability of this Regulation to ESA:**



Paragraphs 3.2.1. to 3.2.6. (former), renumbered as 3.2.2 to 3.2.7.

Insert new paragraphs 3.2.8. and 3.2.9., to read:

**"3.2.8. ESA which are brought to the market as spare parts need no type approval if they are obviously marked as a spare part by an identification number and if they are identical and from the same manufacturer as the corresponding original equipment manufacturer (OEM) part for an already type-approved vehicle.**

**3.2.9. Components sold as aftermarket equipment and intended for the installation in motor vehicles need no type-approval if they are not related to immunity related functions (see paragraph 2.12.). In this case a declaration must be issued by the**

manufacturer that the ESA fulfils the requirements of this Regulation and in particular the limits defined in paragraphs 6.5., 6.6., 6.8. and 6.9.

During a transition period ending the 4 November 2008 the person or legal entity responsible for placing on the market of such a product has to submit all relevant information and/or a sample to a Technical Service which will determine if the equipment is immunity related or not. The result of the inspection shall be available within 3 weeks and not require additional testing. A document according to the example given in annex 3C shall be issued by the Technical Service within the same period. In case of doubts and if the Technical Service refuses to issue an Attestation in line with annex 3C the manufacturer has to apply for type-approval for his product."

Paragraph 4.1.1.3., amend to read:

"4.1.1.3. A manufacturer **may obtain** approval to **this Regulation** if the vehicle has no equipment of the type, which is subject to immunity or emission tests. **Such** approvals do not require testing."

Paragraph 4.1.2., amend to read:

"4.1.2. Type approval of an ESA

Type approval may be granted to an ESA to be fitted either to any vehicle type (**component approval**) or to a specific vehicle type or types requested by the **ESA** manufacturer (**separate technical unit approval**)."

Insert a new paragraph 4.1.3., to read:

"**4.1.3. ESAs, which are intentional RF transmitters, which have not received type-approval in conjunction with a vehicle manufacturer, must be supplied with suitable installation guidelines.**"

Paragraph 5.1., amend to read:

"5.1. An approval number .... The first two digits of this number (at present 03) shall ...."

Paragraph 6., amend to read:

**6. SPECIFICATIONS**

**6.1. General specifications**

**6.1.1. A vehicle and its electrical/electronic system(s) or ESA(s) shall be so designed, constructed and fitted as to enable the vehicle, in normal conditions of use, to comply with the requirements of this Regulation.**

**6.1.1.1. A vehicle shall be tested for radiated emissions and for immunity to radiated disturbances. No tests for conducted emissions or immunity to conducted disturbances are required for vehicle type approval.**

**6.1.1.2. ESA(s) shall be tested for radiated and conducted emissions, for immunity to radiated and conducted disturbances.**

**6.1.2. Before testing the Technical Service has to prepare a test plan in conjunction with the manufacturer, which contains at least mode of operation, stimulated function(s), monitored function(s), pass/fail criteria(s) and intended emissions.**

**6.2. Specifications concerning broadband electromagnetic radiation from vehicles**

**6.2.1. Method of measurement**

**The electromagnetic radiation generated by the vehicle representative of its type shall be measured using the method described in annex 4. The method of measurement shall be defined by the vehicle manufacturer in accordance with the Technical Service.**

**6.2.2. Vehicle broadband type approval limits**

**6.2.2.1. If measurements are made using the method described in annex 4 using a vehicle-to-antenna spacing of  $10.0 \pm 0.2$  m, the limits shall be 32 dB microvolts/m in the 30 to 75 MHz frequency band and 32 to 43 dB microvolts/m in the 75 to 400 MHz frequency band, this limit increasing logarithmically with frequencies above 75 MHz as shown in appendix 2. In the 400 to 1,000 MHz frequency band the limit remains constant at 43 dB microvolts/m.**

**6.2.2.2. If measurements are made using the method described in annex 4 using a vehicle-to-antenna spacing of  $3.0 \pm 0.05$  m, the limits shall be 42 dB microvolts/m in the 30 to 75 MHz frequency band and 42 to 53 dB microvolts/m in the 75 to 400 MHz frequency band, this limit increasing logarithmically with frequencies above 75 MHz as shown in appendix 3. In the 400 to 1,000 MHz frequency band the limit remains constant at 53 dB microvolts/m.**

**6.2.2.3. On the vehicle representative of its type, the measured values, expressed in dB microvolts/m shall be below the type approval limits.**

**6.3. Specifications concerning narrowband electromagnetic radiation from vehicles.**

**6.3.1. Method of measurement**

**The electromagnetic radiation generated by the vehicle representative of its type shall be measured using the method described in annex 5. These shall be defined by the vehicle manufacturer in accordance with the Technical Service.**

**6.3.2. Vehicle narrowband type approval limits**

**6.3.2.1. If measurements are made using the method described in annex 5 using a vehicle-to-antenna spacing of  $10.0 \pm 0.2$  m, the limits shall be 22 dB microvolts/m in the 30 to 75 MHz frequency band and 22 to 33 dB microvolts/m in the 75 to 400 MHz frequency band, this limit increasing logarithmically with frequencies above 75 MHz as shown in appendix 4 of this annex. In**

the 400 to 1,000 MHz frequency band the limit remains constant at 33 dB microvolts/m.

6.3.2.2. If measurements are made using the method described in annex 5 using a vehicle-to-antenna spacing of  $3.0 \pm 0.05$  m, the limit shall be 32 dB microvolts/m in the 30 to 75 MHz frequency band and 32 to 43 dB microvolts/m in the 75 to 400 MHz frequency band, this limit increasing logarithmically with frequencies above 75 MHz as shown in appendix 5. In the 400 to 1,000 MHz frequency band the limit remains constant at 43 dB microvolts/m.

6.3.2.3. On the vehicle representative of its type, the measured values, expressed in dB microvolts/m, shall be below the type approval limit.

6.3.2.4. Notwithstanding the limits defined in paragraphs 6.3.2.1., 6.3.2.2. and 6.3.2.3. of this annex, if, during the initial step described in annex 5, paragraph 1.3., the signal strength measured at the vehicle broadcast radio antenna is less than 20 dB microvolts over the frequency range 76 to 108 MHz measured with an average detector, then the vehicle shall be deemed to comply with the limits for narrowband emissions and no further testing will be required.

6.4. Specifications concerning immunity of vehicles to electromagnetic radiation.

6.4.1. Method of testing

The immunity to electromagnetic radiation of the vehicle representative of its type shall be tested by the method described in annex 5.

6.4.2. Vehicle immunity type approval limits.

6.4.2.1. If tests are made using the method described in annex 5, the field strength shall be 30 volts/m rms in over 90 per cent of the 20 to 2,000 MHz frequency band and a minimum of 25 volts/m rms over the whole 20 to 2,000 MHz frequency band.

6.4.2.2. The vehicle representative of its type shall be considered as complying with immunity requirements if, during the tests performed in accordance with annex 6, there shall be no degradation of performance of "immunity related functions".

6.5. Specification concerning broadband electromagnetic interference generated by ESAs.

6.5.1. Method of measurement

The electromagnetic radiation generated by the ESA representative of its type shall be measured by the method described in annex 7.

6.5.2. ESA broadband type approval limits

6.5.2.1. If measurements are made using the method described in annex 7, the limits shall be 62 to 52 dB microvolts/m in the 30 to 75 MHz frequency band, this limit decreasing logarithmically with frequencies above 30 MHz, and 52 to 63 dB

microvolts/m in the 75 to 400 MHz band, this limit increasing logarithmically with frequencies above 75 MHz as shown in appendix 6. In the 400 to 1,000 MHz frequency band the limit remains constant at 63 dB microvolts/m.

**6.5.2.2.** On the ESA representative of its type, the measured values, expressed in dB microvolts/m, shall be below the type approval limits.

**6.6.** Specifications concerning narrowband electromagnetic interference generated by ESAs.

**6.6.1.** Method of measurement

The electromagnetic radiation generated by the ESA representative of its type shall be measured by the method described in annex 8.

**6.6.2.** ESA narrowband type approval limits.

**6.6.2.1.** If measurements are made using the method described in annex 8, the limits shall be 52 to 42 dB microvolts/m in the 30 to 75 MHz frequency band, this limit decreasing logarithmically with frequencies above 30 MHz, and 42 to 53 dB microvolts/m in the 75 to 400 MHz band, this limit increasing logarithmically with frequencies above 75 MHz as shown in appendix 7. In the 400 to 1,000 MHz frequency band the limit remains constant at 53 dB microvolts/m.

**6.6.2.2.** On the ESA representative of its type, the measured value, expressed in dB microvolts/m shall be below the type approval limits.

**6.7.** Specifications concerning immunity of ESAs to electromagnetic radiation.

**6.7.1.** Method(s) of testing

The immunity to electromagnetic radiation of the ESA representative of its type shall be tested by the method(s) chosen from those described in annex 9.

**6.7.2.** ESA immunity type approval limits

**6.7.2.1.** If tests are made using the methods described in annex 9, the immunity test levels shall be 60 volts/m for the 150 mm stripline testing method, 15 volts/m for the 800 mm stripline testing method, 75 volts/m for the TEM cell testing method, 60 mA for the bulk current injection (BCI) testing method and 30 volts/m for the free field testing method in over 90 per cent of the 20 to 2,000 MHz frequency band, and to a minimum of 50 volts/m for the 150 mm stripline testing method, 12.5 volts/m for the 800 mm stripline testing method, 62.5 volts/m, for the TEM cell testing method, 50 mA for the bulk current injection (BCI) testing method and 25 volts/m for the free field testing method over the whole 20 to 2,000 MHz frequency band.

**6.7.2.2.** The ESA representative of its type shall be considered as complying with immunity requirements if, during the tests performed in accordance with



annex 9, there shall be no degradation of performance of "immunity related functions".

6.8. Specifications concerning the immunity to transient disturbances conducted along supply lines.

6.8.1. Method of testing

The immunity of ESA representative of its type shall be tested by the method(s) according to ISO 7637-2: second edition 2004 as described in annex 10 with the test levels given in table 1.

Test pulse number	Immunity test level	Functional status for systems:	
		Related to immunity related functions	Not related to immunity related functions
1	III	C	D
2a	III	B	D
2b	III	C	D
3a/3b	III	A	D
4	III	B (for ESA which must be operational during engine start phases) C (for other ESA)	D

**Table 1: Immunity of ESA**

6.9. Specifications concerning the emission of conducted disturbances

6.9.1. Method of testing

The emission of ESA representative of its type shall be tested by the method(s) according to ISO 7637-2: second edition 2004 as described in annex 10 for the levels given in table 2.

Polarity of pulse amplitude	Maximum allowed pulse amplitude for	
	Vehicles with 12 V systems	Vehicles with 24 V systems
Positive	+75	+150
Negative	-100	-450

**Table 2: Maximum allowed pulse amplitude**

6.10. Exceptions

6.10.1. Where a vehicle or electrical/electronic system or ESA does not include an electronic oscillator with an operating frequency greater than 9 kHz, it shall be deemed to comply with paragraph 6.3.2. or 6.6.2. and with annexes 5 and 8.

- 6.10.2** Vehicles which do not have electrical/electronic systems with "immunity related functions" need not be tested for immunity to radiated disturbances and shall be deemed to comply with paragraph 6.4. and with annex 6 to this Regulation.
- 6.10.3.** ESAs with no immunity related functions need not be tested for immunity to radiated disturbances and shall be deemed to comply with paragraph 6.7. and with annex 9 to this Regulation.
- 6.10.4.** Electrostatic discharge
- For vehicles fitted with tyres, the vehicle body/chassis can be considered to be an electrically isolated structure. Significant electrostatic forces in relation to the vehicle's external environment only occur at the moment of occupant entry into or exit from the vehicle. As the vehicle is stationary at these moments, no type-approval test for electrostatic discharge is deemed necessary.
- 6.10.5.** Conducted emission
- ESAs that are not switched, contain no switches or do not include inductive loads need not be tested for conducted emission and shall be deemed to comply with paragraph 6.9.
- 6.10.6** The loss of function of receivers during the immunity test, when the test signal is within the receiver bandwidth (RF exclusion band) as specified for the specific radio service/product in the harmonised international EMC standard, does not necessarily lead to a fail criteria.
- 6.10.7.** RF transmitters shall be tested in the transmit mode. Wanted emissions (e.g. from RF transmitting systems) within the necessary bandwidth and out of band emissions are disregarded for the purpose of this Regulation. Spurious emissions are subject to this Regulation.
- 6.10.7.1.** "Necessary Bandwidth": for a given class of emission, the width of the frequency band which is just sufficient to ensure the transmission of information at the rate and with the quality required under specified conditions (article 1, No. 1.152 of the Radio Regulations).
- 6.10.7.2.** "Out-of-band Emissions": Emission on a frequency or frequencies immediately outside the necessary bandwidth which results from the modulation process, but excluding spurious emissions (article 1, No. 1.144 of the Radio regulations).
- 6.10.7.3.** "Spurious Emission": In every modulation process additional undesired signals exist. They are summarised under the expression "spurious emissions". Spurious emissions are emissions on a frequency or frequencies, which are outside the necessary bandwidth and the level of which may be reduced without affecting the corresponding transmission of information. Spurious emissions include harmonic emissions, parasitic emissions, intermodulation products and frequency conversion products, but exclude out-of-band emissions (article 1 No. 1.145 of the Radio Regulations)."

Insert a new paragraph 8.3.3., to read:

**"8.3.3. If the conformity of a component, or STU taken from the series is being verified, production shall be deemed to conform to the requirements of this Regulation in relation to immunity to conducted disturbances and emission if the component or STU shows no degradation of performance of "immunity related functions" up to levels given in paragraph 6.8.1. and does not exceed the levels given in paragraph 6.9.1."**

Paragraphs 12. to 12.4., amend to read:

**"12. TRANSITIONAL PROVISIONS**

**12.1. As from the official date of entry into force of the 03 series of amendments, no Contracting Party applying this Regulation shall refuse to grant ECE approval under this Regulation as amended by the 03 series of amendments.**

**12.2. As from 12 months after the date of entry into force of this Regulation as amended by the 03 series of amendments, Contracting Parties applying this Regulation shall grant approvals only if the vehicle type, component or separate technical unit to be approved meets the requirements of this Regulation as amended by the 03 series of amendments.**

**12.3 Contracting Parties applying this Regulation shall not refuse to grant extensions of approval to the preceding series of amendments to this regulation.**

**12.4. Starting 36 months after the entry into force of the 03 series of amendments to this Regulation, Contracting Parties applying this Regulation may refuse first national registration (first entry into service) of a vehicle, component or separate technical unit which does not meet the requirements of the 03 series of amendments to this Regulation."**

Paragraph 12.5., should be deleted.

Appendices 1, 2, 3, 4, 5, 6, amend to read:

"Appendix 1

**List of standards referred to in this Regulation**

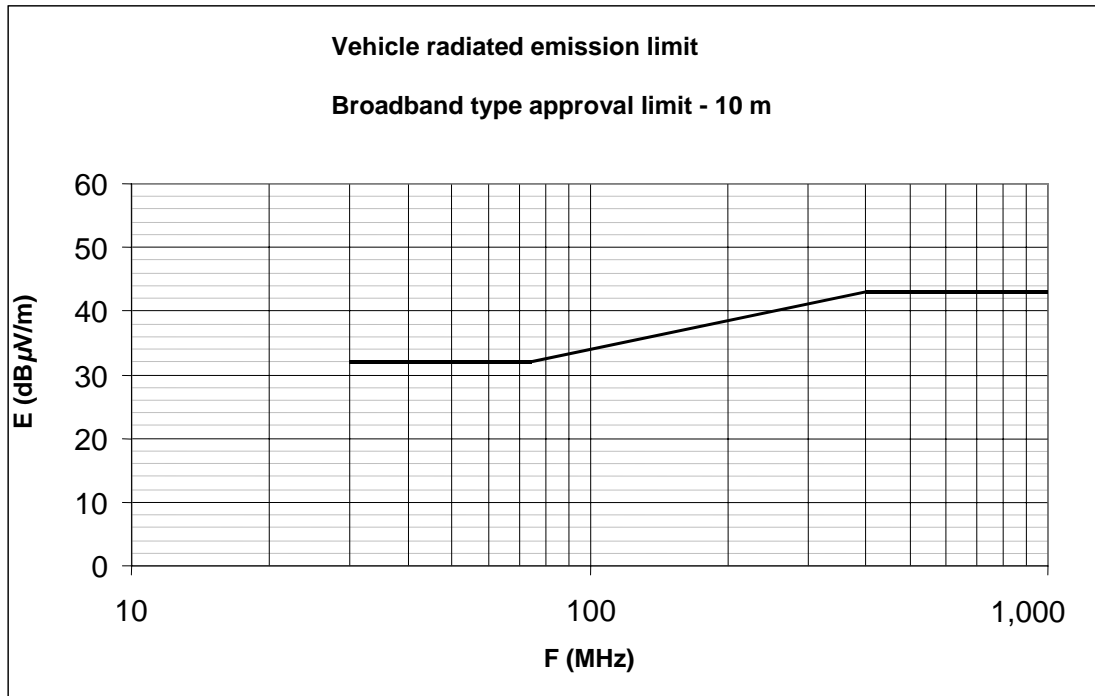
- 1. CISPR 12 "Vehicles', motorboats' and spark-ignited engine-driven devices' radio disturbance characteristics — Limits and methods of measurement", fifth edition 2001**
- 2. CISPR 16-1-4 "Specifications for radio disturbance and immunity measuring apparatus and methods - Part 1: Radio disturbance and immunity measuring apparatus", Edition 1.1. 2004**
- 3. CISPR 25 "Limits and methods of measurement of radio disturbance characteristics for the protection of receivers used on board vehicles", second edition 2002**
- 4. ISO 7637-1 "Road vehicles - Electrical disturbance from conduction and coupling - Part 1: Definitions and general considerations", second edition 2002**
- 5. ISO 7637-2 "Road vehicles - Electrical disturbance from conduction and coupling - Part 2: Electrical transient conduction along supply lines only on vehicles with nominal 12 V or 24 V supply voltage", second edition 2004**
- 6. ISO-EN 17025 "General requirements for the competence of testing and calibration laboratories", first edition 1999**
- 7. ISO 11451 "Road vehicles - Electrical disturbances by narrowband radiated electromagnetic energy - Vehicle test methods":**
  - Part 1: General and definitions (ISO DIS 11451-1: third edition 2005)**
  - Part 2: Off-vehicle radiation source (FDIS 11451-2: third edition 2005)**
  - Part 4: Bulk current injection (BCI) (ISO 11451-4: first edition 1995)**
- 8. ISO 11452 "Road vehicles - Electrical disturbances by narrowband radiated electromagnetic energy - Component test methods":**
  - Part 1: General and definitions (ISO DIS 11452-1: third edition 2005)**
  - Part 2: Absorber-lined chamber (ISO DIS 11452-2: second edition 2004)**
  - Part 3: Transverse electromagnetic mode (TEM) cell (ISO 11452-3: third edition 2001)**
  - Part 4: Bulk current injection (BCI) (ISO DIS 11452-4: third edition 2005)**
  - Part 5: Strip line (ISO 11452-5: second edition 2002)**
- 9. ITU Radio Regulations, Edition 2001**

Appendix 2

Vehicle broadband reference limits

Antenna-vehicle separation : 10 m

<b>Limit E (dB<math>\mu</math>V/m) at frequency F (MHz)</b>		
<b>30 - 75 MHz</b>	<b>75 - 400 MHz</b>	<b>400 - 1,000 MHz</b>
<b>E = 32</b>	<b>E = 32 + 15.13 log (F/75)</b>	<b>E = 43</b>



Frequency - megahertz - logarithmic

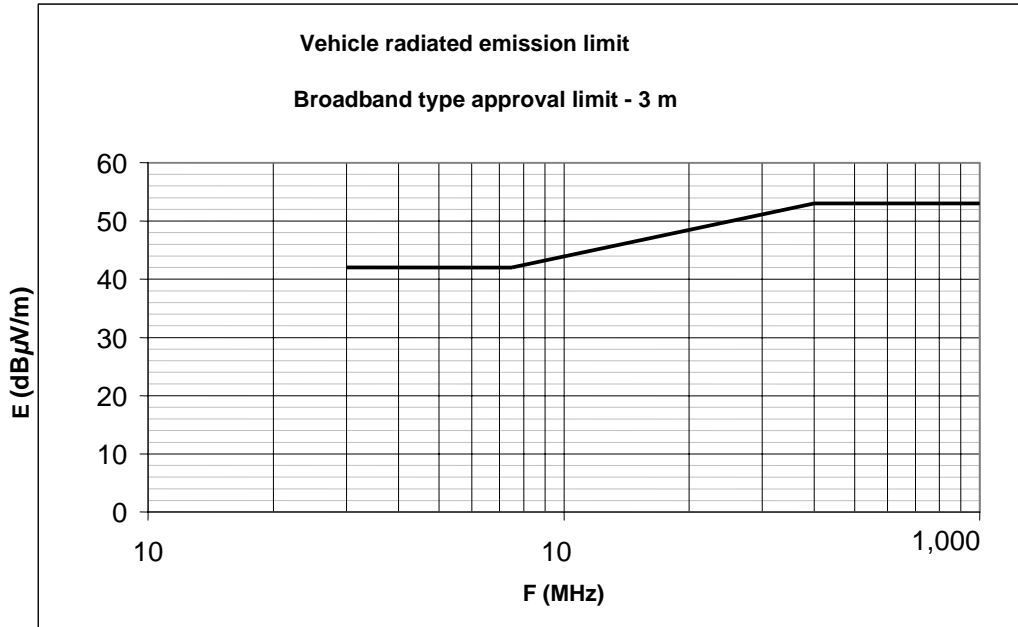
(See paragraph 6.2.2.1. of this Regulation)

Appendix 3

**Vehicle broadband reference limits**

**Antenna-vehicle separation : 3 m**

<b>Limit E (dB<math>\mu</math>V/m) at frequency F (MHz)</b>		
<b>30 - 75 MHz</b>	<b>75 - 400 MHz</b>	<b>400 - 1,000 MHz</b>
<b>E = 42</b>	<b>E = 42 + 15.13 log (F/75)</b>	<b>E = 53</b>



Frequency - megahertz - logarithmic

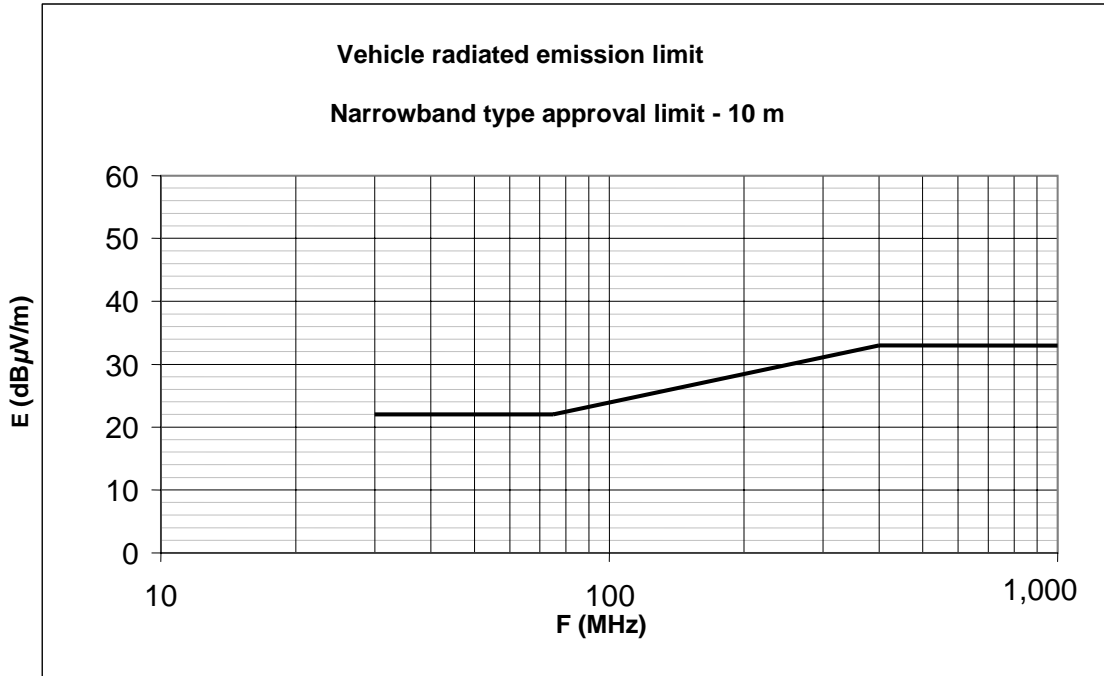
(See paragraph 6.2.2.2. of this Regulation)

Appendix 4

Vehicle narrowband reference limits

Antenna-vehicle separation : 10 m

<b>Limit E (dB<math>\mu</math>V/m) at frequency F (MHz)</b>		
<b>30 - 75 MHz</b>	<b>75 - 400 MHz</b>	<b>400 - 1,000 MHz</b>
<b>E = 22</b>	<b>E = 22 + 15.13 log (F/75)</b>	<b>E = 33</b>



Frequency - megahertz - logarithmic

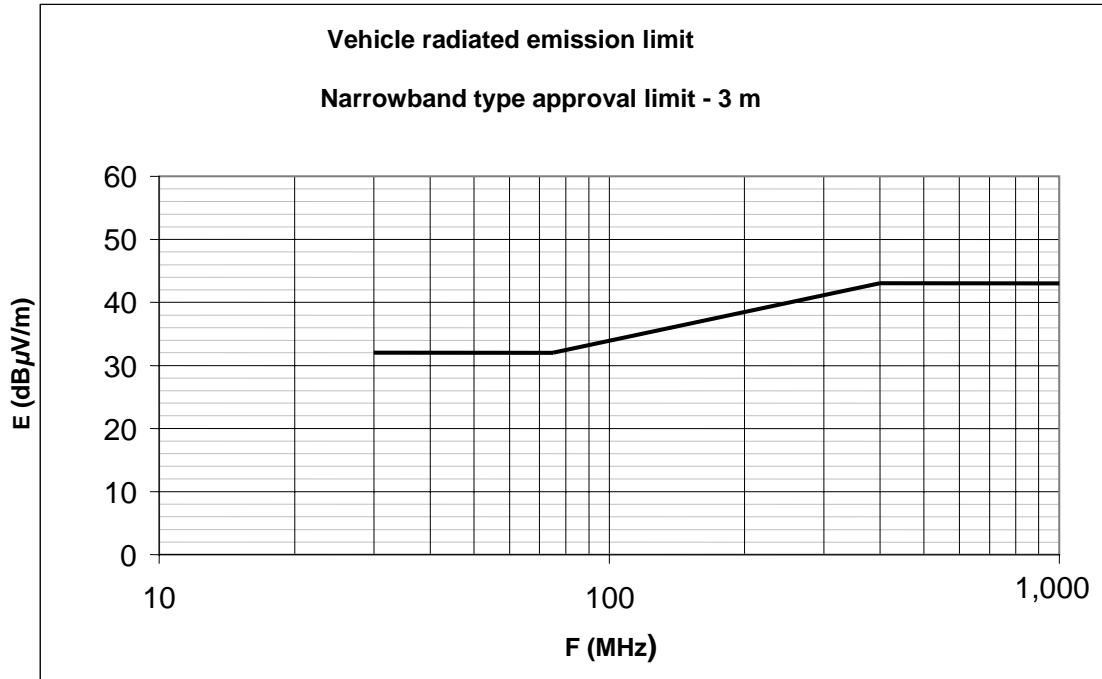
(See paragraph 6.3.2.1. of this Regulation)

Appendix 5

**Vehicle narrowband reference limits**

**Antenna-vehicle separation : 3 m**

<b>Limit E (dB<math>\mu</math>V/m) at frequency F (MHz)</b>		
<b>30 - 75 MHz</b>	<b>75 - 400 MHz</b>	<b>400 - 1,000 MHz</b>
<b>E = 32</b>	<b>E = 32 + 15.13 log (F/75)</b>	<b>E = 43</b>



Frequency - megahertz - logarithmic

(See paragraph 6.3.2.2. of this Regulation)

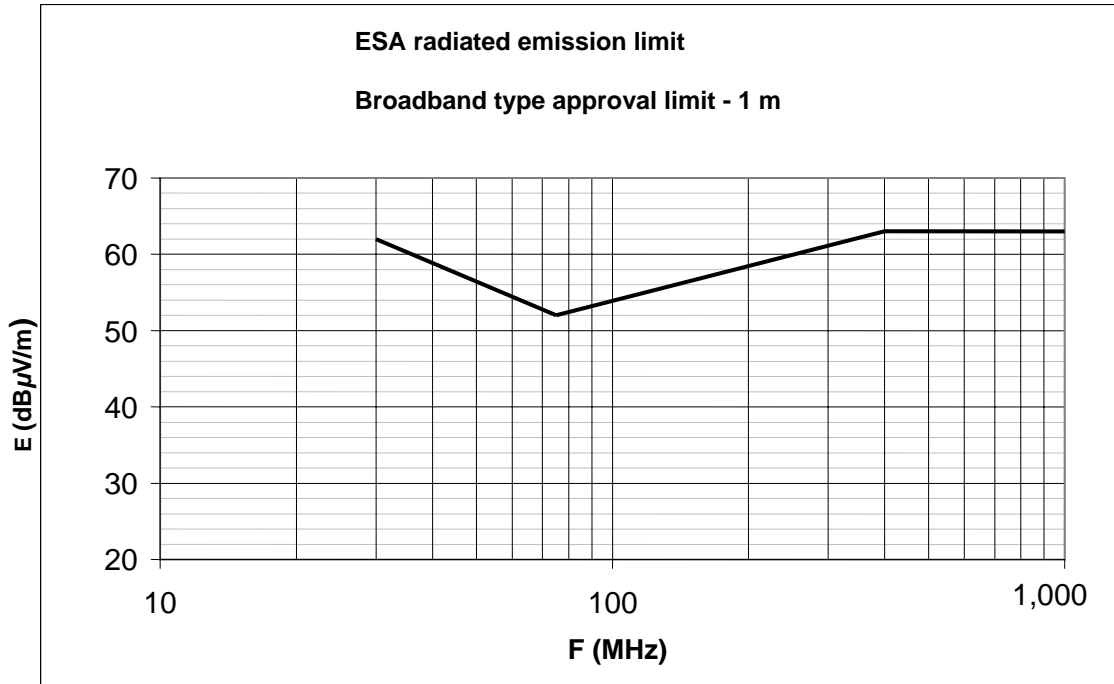


Appendix 6

Electrical/electronic sub-assembly

**Broadband reference limits**

<b>Limit E (dB<math>\mu</math>V/m) at frequency F (MHz)</b>		
<b>30 - 75 MHz</b>	<b>75 - 400 MHz</b>	<b>400 - 1,000 MHz</b>
<b><math>E = 62 - 25.13 \log (F/30)</math></b>	<b><math>E = 52 + 15.13 \log (F/75)</math></b>	<b><math>E = 63</math></b>



Frequency - megahertz - logarithmic

(See paragraph 6.5.2.1. of this Regulation)"

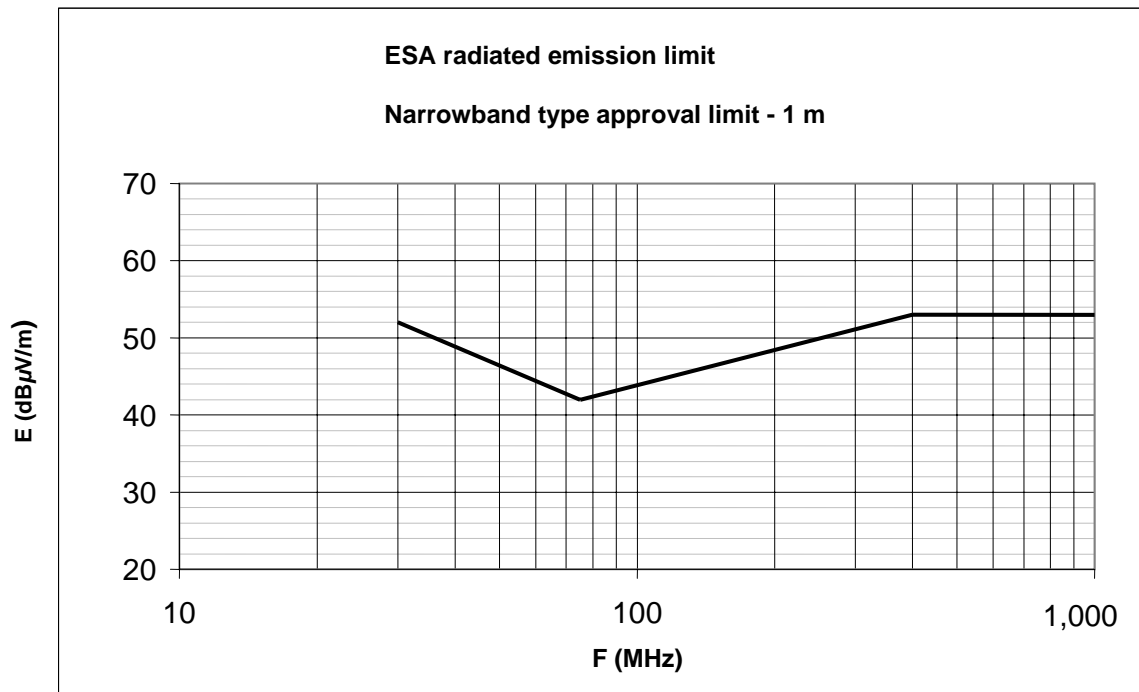
Insert a new appendix 7, to read:

**"Appendix 7**

**Electrical/electronic sub-assembly**

**Narrowband reference limits**

<b>Limit E (dB<math>\mu</math>V/m) at frequency F (MHz)</b>		
<b>30 - 75 MHz</b>	<b>75 - 400 MHz</b>	<b>400 - 1,000 MHz</b>
<b><math>E = 52 - 25.13 \log (F/30)</math></b>	<b><math>E = 42 + 15.13 \log (F/75)</math></b>	<b><math>E = 53</math></b>



**Frequency - megahertz - logarithmic**

**(See paragraph 6.6.2.1. of this Regulation)"**

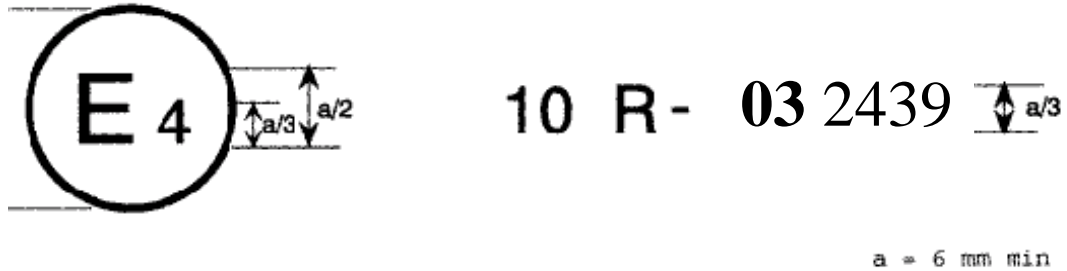
Annex 1, amend to read (footnote \*/ not changed):

"Annex 1

EXAMPLES OF APPROVAL MARKS

Model A

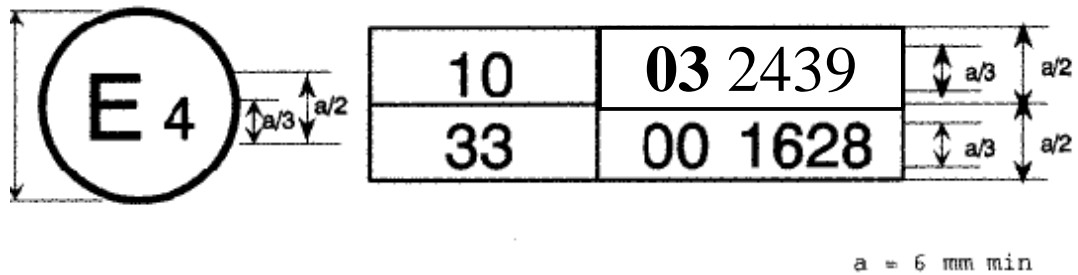
(See paragraph 5.2. of this Regulation)



The above approval mark affixed to a vehicle or ESA shows that the vehicle type concerned has, with regard to electromagnetic compatibility, been approved in the Netherlands (E 4) pursuant to Regulation No. 10 under approval No. **022439**. The approval number indicates that the approval was granted according to the requirements of Regulation No. 10 as amended by the **03** series of amendments.

Model B

(See paragraph 5.2. of this Regulation)



The above approval mark affixed to a vehicle or ESA shows that the vehicle type concerned has, with regard to electromagnetic compatibility, been approved in the Netherlands (E 4) pursuant to Regulations Nos. 10 and 33. \*/ The approval numbers indicate that, at the date when the respective approvals were given, Regulation No. 10 included the **03** series of amendments and Regulation No. 33 was still in its original form."

Annex 2A, amend to read:

"Annex 2A

INFORMATION DOCUMENT

FOR TYPE-APPROVAL OF A VEHICLE WITH RESPECT TO  
ELECTROMAGNETIC COMPATIBILITY

The following information shall be supplied in triplicate and shall include a list of contents.

Any drawings shall be supplied in appropriate scale and in sufficient detail on size A4 or on a folder of A4 format.

Photographs, if any, shall show sufficient detail.

If the systems, component or separate technical units have electronic controls, information concerning their performance shall be supplied.

**GENERAL**

1. Make (trade name of manufacturer): .....
2. Type: .....
3. Category of vehicle: .....
4. Name and address of manufacturer: .....  
Name and address of authorised representative, if any: .....
5. Address(es) of assembly plant(s): .....

**GENERAL CONSTRUCTION CHARACTERISTICS OF THE VEHICLE**

6. Photograph(s) and/or drawing(s) of a representative vehicle: .....
7. Position and arrangement of the engine: .....

**POWER PLANT**

8. Manufacturer: .....
9. Manufacturer's engine code as marked on the engine: .....
10. Internal combustion engine:
11. Working principle: positive ignition/compression ignition, four-stroke/two stroke 1/
12. Number and arrangement of cylinders: .....
13. Fuel feed:
14. By fuel injection (compression ignition only): yes/no 1/
15. Electronic control unit:
16. Make(s): .....
17. Description of the system: .....
18. By fuel injection (positive ignition only): yes/no 1/
19. Electrical system:
20. Rated voltage: ..... V, positive/negative ground 1/
21. Generator:
22. Type: .....
23. Ignition:
24. Make(s): .....
25. Type(s): .....
26. Working principle: .....

- 27. **LPG fuelling system: yes/no 1/**
- 28. **Electronic engine management control unit for LPG fuelling:**
- 29. **Make(s): .....**
- 30. **Type(s): .....**
- 31. **NG fuelling system: yes/no 1/**
- 32. **Electronic engine management control unit for NG fuelling:**
- 33. **Make(s): .....**
- 34. **Type(s): .....**
- 35. **Electric motor:**
- 36. **Type (winding, excitation): .....**
- 37. **Operating voltage: .....**

**GAS FUELLED ENGINES (in the case of systems laid-out in a different manner, supply equivalent information)**

- 38. **Electronic control unit (ECU):**
- 39. **Make(s): .....**
- 40. **Type(s): .....**

**TRANSMISSION**

- 41. **Type (mechanical, hydraulic, electric, etc.): .....**
- 42. **A brief description of the electrical/electronic components (if any): .....**

**SUSPENSION**

- 43. **A brief description of the electrical/electronic components (if any): .....**

**STEERING**

- 44. **A brief description of the electrical/electronic components (if any): .....**

**BRAKES**

- 45. **Anti-lock braking system: yes/no/optional 1/**
- 46. **For vehicles with anti-lock systems, description of system operation (including any electronic parts), electric block diagram, hydraulic or pneumatic circuit plan: .....**

**BODYWORK**

- 47. **Type of bodywork: .....**
- 48. **Materials used and methods of construction: .....**
- 49. **Windscreen and other windows:**
- 50. **A brief description of the electrical/electronic components (if any) of the window lifting mechanism: .....**
- 51. **Rear-view mirrors (state for each mirror): .....**
- 52. **A brief description of the electronic components (if any) of the adjustment system: .....**
- 53. **Safety belts and/or other restraint systems:**
- 54. **A brief description of the electrical/electronic components (if any): .....**
- 55. **Suppression of radio interference:**
- 56. **Description and drawings/photographs of the shapes and constituent materials of the part of the body forming the engine compartment and the part of the passenger compartment nearest to it: .....**

- 57. Drawings or photographs of the position of the metal components housed in the engine compartment (e.g. heating appliances, spare wheel, air filter, steering mechanism, etc.): .....
- 58. Table and drawing of radio interference control equipment: .....
- 59. Particulars of the nominal value of the direct current resistance and, in the case of resistive ignition cables, of their nominal resistance per metre: .....

**LIGHTING AND LIGHT SIGNALLING DEVICES**

- 60. A brief description of electrical/electronic components other than lamps (if any): .....

**MISCELLANEOUS**

- 61. Devices to prevent unauthorised use of the vehicle:
- 62. A brief description of the electrical/electronic components (if any): .....
- 63. Table of installation and use of RF transmitters in the vehicle(s), if applicable (see paragraph 3.1.8. of this Regulation):

frequency bands [Hz]	max. output power [W]	antenna position at vehicle, specific conditions for installation and/or use

The applicant for type-approval must also supply, where appropriate:

**Appendix 1**

A list (with make(s) and type(s) of all electrical and/or electronic components concerned by this Regulation (see paragraphs 2.9. and 2.10. of this Regulation) and not previously listed.

**Appendix 2**

Schematics or drawing of the general arrangement of electrical and/or electronic components (concerned by this Regulation) and the general wiring harness arrangement.

**Appendix 3**

Description of vehicle chosen to represent the type  
 Body style: .....  
 Left or right hand drive: .....  
 Wheelbase: .....

**Appendix 4**

Relevant test report(s) supplied by the manufacturer from a test laboratory accredited to ISO 17025 and recognized by the Approval Authority for the purpose of drawing up the type-approval certificate"

Insert a new annex 3 C, to read:

"Annex 3 C

**ATTESTATION WITH REGARD TO PARAGRAPH 3.2.9.**

(maximum format: A4 (210 × 297 mm))

**Applicant:** .....  
**General description of product:** .....  
**Information submitted by the applicant:** .....  
**This ESA can be used on any vehicle type with the following restrictions:** .....  
**Installation conditions, if any:** .....

**We confirm that the product described above is not immunity related according to Regulation No. 10. Any testing according to immunity as defined in this Regulation is not required.**

**Technical Service responsible for evaluation:** .....

**Place:** .....

**Date:** .....

**Signature:** ....."

Annex 4, amend to read:

"Annex 4

**METHOD OF MEASUREMENT OF RADIATED BROADBAND  
ELECTROMAGNETIC EMISSIONS FROM VEHICLES**

**1. GENERAL**

**1.1. The test method described in this annex shall only be applied to vehicles.**

**1.2. Test method**

**This test is intended to measure the broadband emissions generated by electrical or electronic systems fitted to the vehicle (e.g. ignition system or electric motors).**

**If not otherwise stated in this annex the test shall be performed according to CISPR 12 (fifth edition 2001).**

**2. VEHICLE STATE DURING TESTS**

**2.1. Engine**

**The engine shall be in operation according to CISPR 12 (fifth edition 2001) clause 5.3.2.**

## **2.2. Other vehicle systems**

All equipment capable of generating broadband emissions which can be switched on permanently by the driver or passenger should be in operation in maximum load, e.g. wiper motors or fans. The horn and electric window motors etc. are excluded because they are not used continuously.

## **3. MEASURING LOCATION**

**3.1** As an alternative to the requirements of CISPR 12 (fifth edition 2001) for vehicles of category L the test surface may be any location that fulfils the conditions shown in the figure 1 in the appendix to this annex. In this case the measuring equipment must lie outside the part shown in the figures 1 and 2 of the appendix to this annex.

**3.2** Enclosed test facilities may be used if correlation can be shown between the results obtained in the enclosed test facility and those obtained at an outdoor site. Enclosed test facilities do not need to meet the dimensional requirements of the outdoor site other than the distance from the antenna to the vehicle and the height of the antenna.

## **4. TEST REQUIREMENTS**

**4.1.** The limits apply throughout the frequency range 30 to 1,000 MHz for measurements performed in a semi anechoic chamber or an outdoor test site.

**4.2.** Measurements can be performed with either quasi-peak or peak detectors. The limits given in paragraphs 6.2. and 6.5. of this Regulation are for quasi-peak detectors. If peak detectors are used a correction factor of 20 dB as defined in CISPR 12 (fifth edition 2001) shall be applied.

### **4.3. Measurements**

The technical service shall perform the test at the intervals specified in the CISPR 12 (fifth edition 2001) standard throughout the frequency range 30 to 1,000 MHz.

Alternatively, if the manufacturer provides measurement data for the whole frequency band from a test laboratory accredited to the applicable parts of ISO 17025 (first edition 1999) and recognized by the Approval Authority, the Technical Service may divide the frequency range in 14 frequency bands 30 – 34, 34 – 45, 45 – 60, 60 – 80, 80 – 100, 100 – 130, 130 – 170, 170 – 225, 225 – 300, 300–400, 400 – 525, 525 – 700, 700 – 850, 850 – 1,000 MHz and perform tests at the 14 frequencies giving the highest emission levels within each band to confirm that the vehicle meets the requirements of this annex.

In the event that the limit is exceeded during the test, investigations shall be made to ensure that this is due to the vehicle and not to background radiation.



#### 4.4. Readings

The maximum of the readings relative to the limit (horizontal and vertical polarisation and antenna location on the left and right-hand sides of the vehicle) in each of the 14 frequency bands shall be taken as the characteristic reading at the frequency at which the measurements were made.

#### Annex 4 – Appendix 1

Figure 1

Clear horizontal surface free of electromagnetic reflection  
delimitation of the surface defined by an ellipse

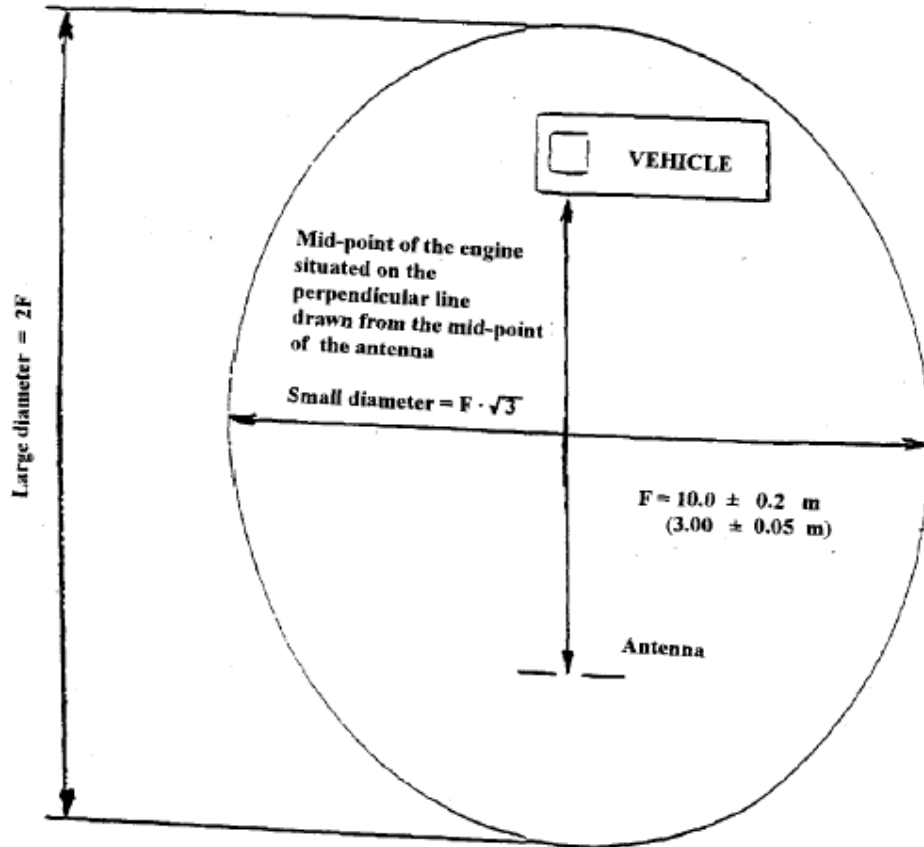
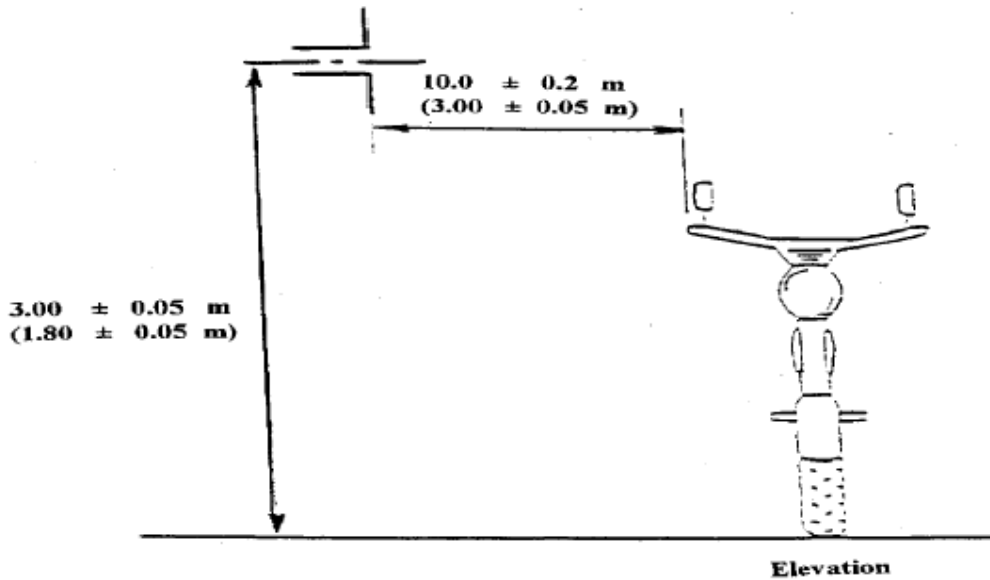
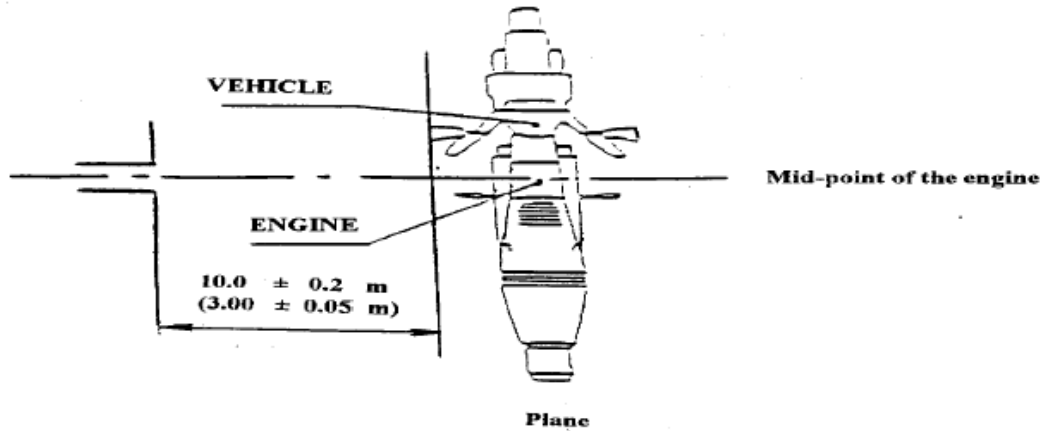


Figure 2

Position of antenna in relation to the vehicle



Dipole antenna in position to measure the vertical radiation components



Dipole antenna in position to measure the horizontal radiation components"

Annex 5, amend to read:

"Annex 5

**METHOD OF MEASUREMENT OF RADIATED NARROWBAND  
ELECTROMAGNETIC EMISSIONS FROM VEHICLES**

**1. GENERAL**

**1.1. The test method described in this annex shall only be applied to vehicles.**

## **1.2. Test method**

**This test is intended to measure the narrowband electromagnetic emissions such as might emanate from microprocessor-based systems or other narrowband source.**

**If not otherwise stated in this annex the test shall be performed according to CISPR 12 (fifth edition 2001) or to CISPR 25 (second edition 2002).**

- 1.3 As an initial step the levels of emissions in the FM frequency band (76 to 108 MHz) shall be measured at the vehicle broadcast radio antenna with an average detector. If the level specified in paragraph 6.3.2.4 of this Regulation is not exceeded, then the vehicle shall be deemed to comply with the requirements of this annex in respect of that frequency band and the full test shall not be carried out.**

## **2. VEHICLE STATE DURING TESTS**

- 2.1. The ignition switch shall be switched on. The engine shall not be operating.**
- 2.2. The vehicle's electronic systems shall all be in normal operating mode with the vehicle stationary.**
- 2.3. All equipment which can be switched on permanently by the driver or passenger with internal oscillators > 9 kHz or repetitive signals should be in normal operation.**

## **3. TEST REQUIREMENTS**

- 3.1. The limits apply throughout the frequency range 30 to 1,000 MHz for measurements performed in a semi anechoic chamber or an outdoor test site.**
- 3.2. Measurements shall be performed with an average detector.**
- 3.3. Measurements**

**The technical service shall perform the test at the intervals specified in the CISPR 12 (fifth edition 2001) standard throughout the frequency range 30 to 1,000 MHz.**

**Alternatively, if the manufacturer provides measurement data for the whole frequency band from a test laboratory accredited to the applicable parts of ISO 17025 (first edition 1999) and recognized by the Approval Authority, the Technical Service may divide the frequency range in 14 frequency bands 30 – 34, 34 – 45, 45 – 60, 60 – 80, 80 – 100, 100 – 130, 130 – 170, 170 – 225, 225 – 300, 300– 400, 400 – 525, 525 – 700, 700 – 850, 850 – 1,000 MHz and perform tests at the 14 frequencies giving the highest emission levels within each band to confirm that the vehicle meets the requirements of this annex.**

In the event that the limit is exceeded during the test, investigations shall be made to ensure that this is due to the vehicle and not to background radiation including broadband radiation from any ESA.

### 3.4. Readings

The maximum of the readings relative to the limit (horizontal and vertical polarisation and antenna location on the left and right-hand sides of the vehicle) in each of the 14 frequency bands shall be taken as the characteristic reading at the frequency at which the measurements were made."

Annex 6, amend to read:

"Annex 6

## **METHOD OF TESTING FOR IMMUNITY OF VEHICLES TO ELECTROMAGNETIC RADIATION**

### **1. GENERAL**

**1.1. The test method described in this annex shall only be applied to vehicles.**

### **1.2. Test method**

**This test is intended to demonstrate the immunity of the vehicle electronic systems. The vehicle shall be subject to electromagnetic fields as described in this annex. The vehicle shall be monitored during the tests.**

**If not otherwise stated in this annex the test shall be performed according to ISO 11451-2: third edition 2005.**

### **1.3 Alternative test methods**

**The test may be alternatively performed in an outdoor test site for all vehicles. The test facility shall comply with (national) legal requirements regarding the emission of electromagnetic fields.**

**If a vehicle is longer than 12 m and/or wider than 2.60 m and/or higher than 4.00 m, BCI method according to ISO 11451-4 (first edition 1995) can be used in the frequency range 20 – 2,000 MHz with levels defined in paragraph 6.7.2.1. of this Regulation.**

### **2. VEHICLE STATE DURING TESTS**

**2.1 The vehicle shall be in an unladen condition except for necessary test equipment.**

**2.1.1. The engine shall normally turn the driving wheels at a steady speed of 50 km/h if there is no technical reason due to the vehicle to define a different condition. For vehicles of categories L<sub>1</sub> and L<sub>2</sub> the steady speed shall normally be turned at 25 km/h. The vehicle shall be on an appropriately loaded dynamometer or alternatively supported on insulated axle stands with minimum ground clearance if no dynamometer is available. Where appropriate, transmission**

shafts, belts or chains may be disconnected (e.g. trucks, two- and three wheel vehicles).

**2.1.2. Basic vehicle conditions**

The paragraph defines minimum test conditions (as far as applicable) and failures criteria for vehicle immunity tests. Other vehicle systems, which can affect immunity related functions must be tested in a way to be agreed between manufacturer and technical service.

<b>"50 km/h cycle" vehicle test conditions</b>	<b>Failure criteria</b>
<b>Vehicle speed 50 km/h (respectively 25 km/h for L<sub>1</sub>, L<sub>2</sub> vehicles) ± 20 % (vehicle driving the rollers). If the vehicle is equipped with a cruise control system, it shall be operational</b>	<b>Speed variation greater than ± 10 % of the nominal speed In case of automatic gearbox: change of gear ratio inducing a speed variation greater than ± 10 % of the nominal speed</b>
<b>Dipped beams ON (manual mode)</b>	<b>Lighting OFF</b>
<b>Front wiper ON (manual mode) maximum speed</b>	<b>Complete stop of front wiper</b>
<b>Direction indicator on driver's side ON</b>	<b>Frequency change (lower than 0.75 Hz or greater than 2.25 Hz) Duty cycle change (lower than 25 % or greater than 75 %)</b>
<b>Adjustable suspension in normal position</b>	<b>Unexpected significant variation</b>
<b>Driver's seat and steering wheel in medium position</b>	<b>Unexpected variation greater than 10 % of total range</b>
<b>Alarm unset</b>	<b>Unexpected activation of alarm</b>
<b>Horn OFF</b>	<b>Unexpected activation of horn</b>
<b>Airbag and safety restraint systems operational with inhibited passenger airbag if this function exists</b>	<b>Unexpected activation</b>
<b>Automatic doors closed</b>	<b>Unexpected opening</b>
<b>Adjustable endurance brake lever in normal position</b>	<b>Unexpected activation</b>

<b>"Brake cycle" vehicle test conditions</b>	<b>Failure criteria</b>
<b>To be defined in brake cycle test plan. This must include operation of the brake pedal (unless there are technical reasons not to do so) but not necessarily an anti-lock brake system action.</b>	<b>Stop lights inactivated during cycle Brake warning light ON with loss of function Unexpected activation</b>

**2.1.3. All equipment which can be switched on permanently by the driver or passenger should be in normal operation.**

- 2.1.4.** All other systems which affect the driver's control of the vehicle shall be (on) as in normal operation of the vehicle.
- 2.2.** If there are vehicle electrical/electronic systems which form an integral part of the direct control of the vehicle, which will not operate under the conditions described in paragraph 4.1., it will be permissible for the manufacturer to provide a report or additional evidence to the testing authority that the vehicle electrical/electronic system meets the requirements of this Regulation. Such evidence shall be retained in the type-approval documentation.
- 2.3.** Only non-perturbing equipment shall be used while monitoring the vehicle. The vehicle exterior and the passenger compartment shall be monitored to determine whether the requirements of this annex are met (e.g. by using (a) video camera(s), a microphone, etc.).
- 3.** REFERENCE POINT
- 3.1.** For the purposes of this annex, the reference point is the point at which the field strength shall be established and shall be defined as follows:
- 3.2.** For category M, N, O vehicles according to ISO 11451-2 third edition 2005
- 3.3.** For category L vehicles:
- 3.3.1.** at least 2 m horizontally from the antenna phase centre or at least 1 m vertically from the radiating elements of a TLS,
- 3.3.2.** on the vehicle's centre line (plane of longitudinal symmetry),
- 3.3.3.** at a height of  $1.0 \pm 0.05$  m above the plane on which the vehicle rests or  $2.0 \pm 0.05$  m if the minimum height of the roof of any vehicle in the model range exceeds 3.0 m,
- 3.3.4.** either:
- at  $1.0 \pm 0.2$  m behind the vertical centreline of the vehicle's front wheel (point C in figure 1 of the appendix to this annex) in the case of three-wheeled vehicles,  
or:
- at  $0.2 \pm 0.2$  m behind the vertical centreline of the vehicle's front wheel (point D in figure 2 of the appendix to this annex) in the case of two-wheeled vehicles.
- 3.3.5.** If it is decided to radiate the rear of the vehicle, the reference point shall be established as in paragraphs 3.3.1. to 3.3.4. The vehicle shall then be installed facing away from the antenna and positioned as if it had been horizontally rotated 180 around its centre point, i.e. such that the distance from the antenna to the nearest part of the outer body of the vehicle remains the same. This is illustrated in figure 3 of the appendix to this annex.

#### **4. TEST REQUIREMENTS**

##### **4.1. Frequency range, dwell times, polarisation**

**The vehicle shall be exposed to electromagnetic radiation in the 20 to 2,000 MHz frequency ranges in vertical polarisation.**

**The test signal modulation shall be:**

**(a) AM, with 1 kHz modulation and 80 per cent modulation depth in the 20 - 800 MHz frequency range, and**

**(b) PM, t on 577  $\mu$ s, period 4,600  $\mu$ s in the 800 – 2,000 MHz frequency range,**

**if not otherwise agreed between technical service and vehicle manufacturer.**

**Frequency step size and dwell time shall be chosen according to ISO 11451-1: third edition 2005.**

**4.1.1. The technical service shall perform the test at the intervals specified in ISO 11451-1: third edition 2005 throughout the frequency range 20 to 2,000 MHz.**

**Alternatively, if the manufacturer provides measurement to data for the whole frequency band from a test laboratory accredited to the applicable parts of ISO 17025 (first edition 1999) and recognized by the Approval Authority, the Technical Service may choose a reduced number of spot frequencies in the range, e.g. 27, 45, 65, 90, 120, 150, 190, 230, 280, 380, 450, 600, 750, 900, 1,300, and 1,800 MHz to confirm that the vehicle meets the requirements of this annex.**

**If a vehicle fails the test defined in this annex, it must be verified as having failed under the relevant test conditions and not as a result of the generation of uncontrolled fields.**

#### **5. GENERATION OF REQUIRED FIELD STRENGTH**

##### **5.1. Test methodology**

**5.1.1. The substitution method according to ISO 11451-1: third edition 2005 shall be used to establish the test field conditions.**

##### **5.1.2. Calibration**

**For Transmission-Line-Systems (TLS) one field probe at the facility reference point shall be used.**

**For antennas four field probes at the facility reference line shall be used.**

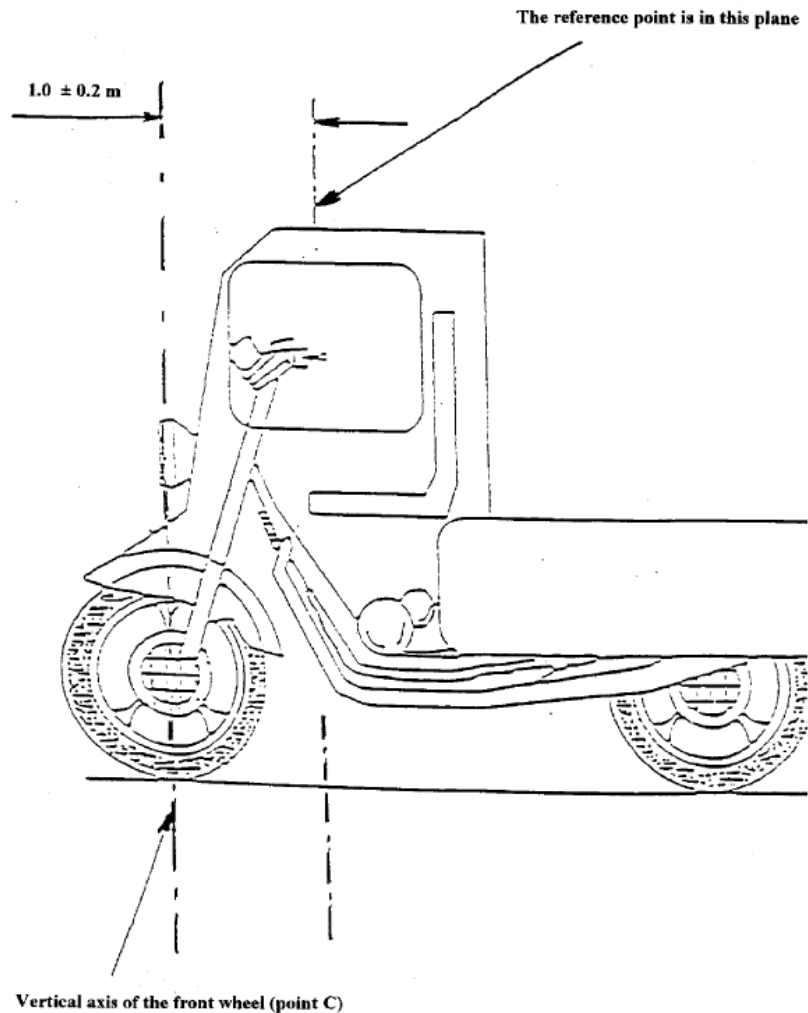
##### **5.1.3. Test phase**

The vehicle shall be positioned with the centre line of the vehicle on the facility reference point or line. The vehicle shall normally face a fixed antenna. However, where the electronic control units and the associated wiring harness are predominantly in the rear of the vehicle, the test should normally be carried out with the vehicle facing away from the antenna. In the case of long vehicles (i.e. excluding vehicles of categories L, M<sub>1</sub> and N<sub>1</sub>), which have electronic control units and associated wiring harness predominantly towards the middle of the vehicle, a reference point may be established based on either the right side surface or the left side surface of the vehicle. This reference point shall be at the midpoint of the vehicle's length or at one point along the side of the vehicle chosen by the manufacturer in conjunction with the competent authority after considering the distribution of electronic systems and the layout of any wiring harness.

Such testing may only take place if the physical construction of the chamber permits. The antenna location must be noted in the test report."

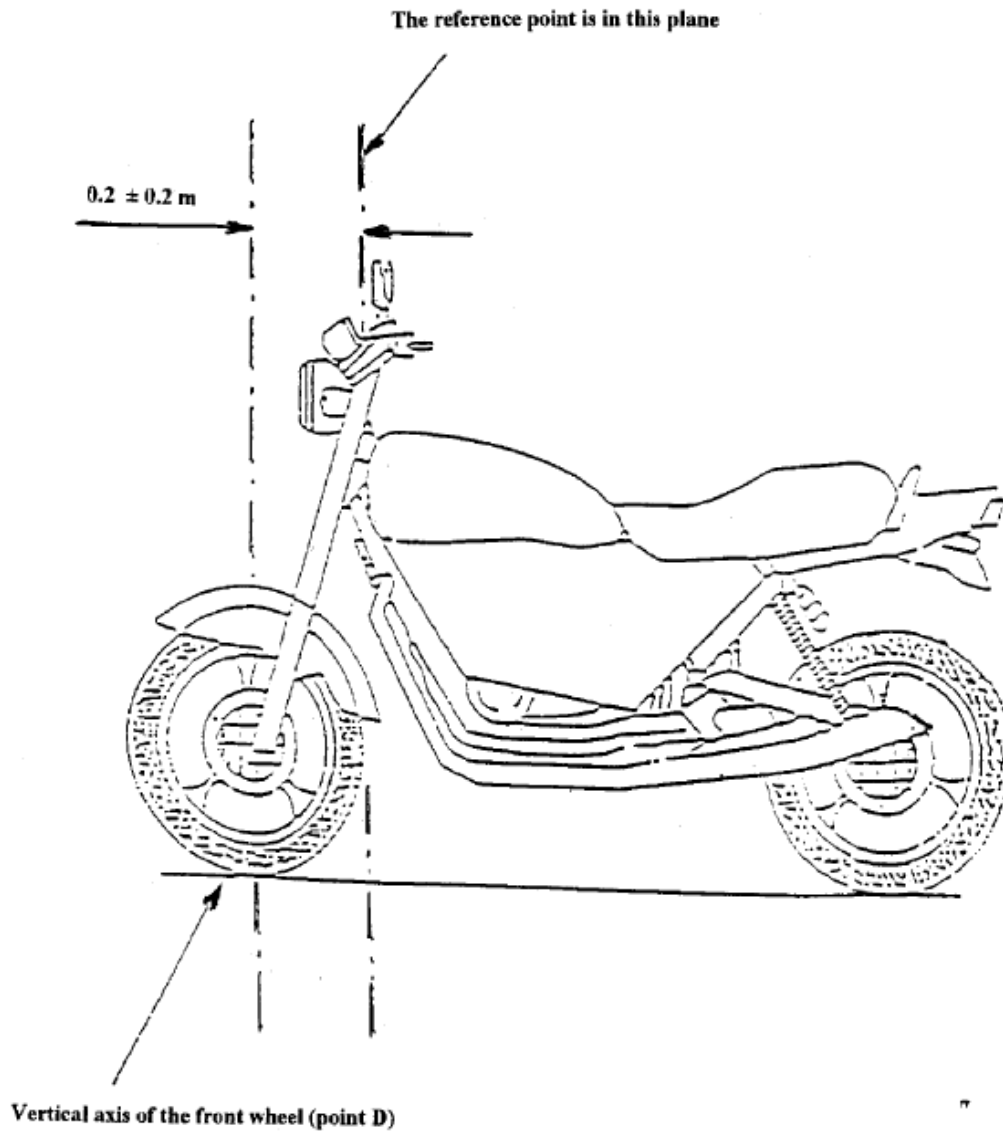
Annex 6 – Appendix 1

Figure 1

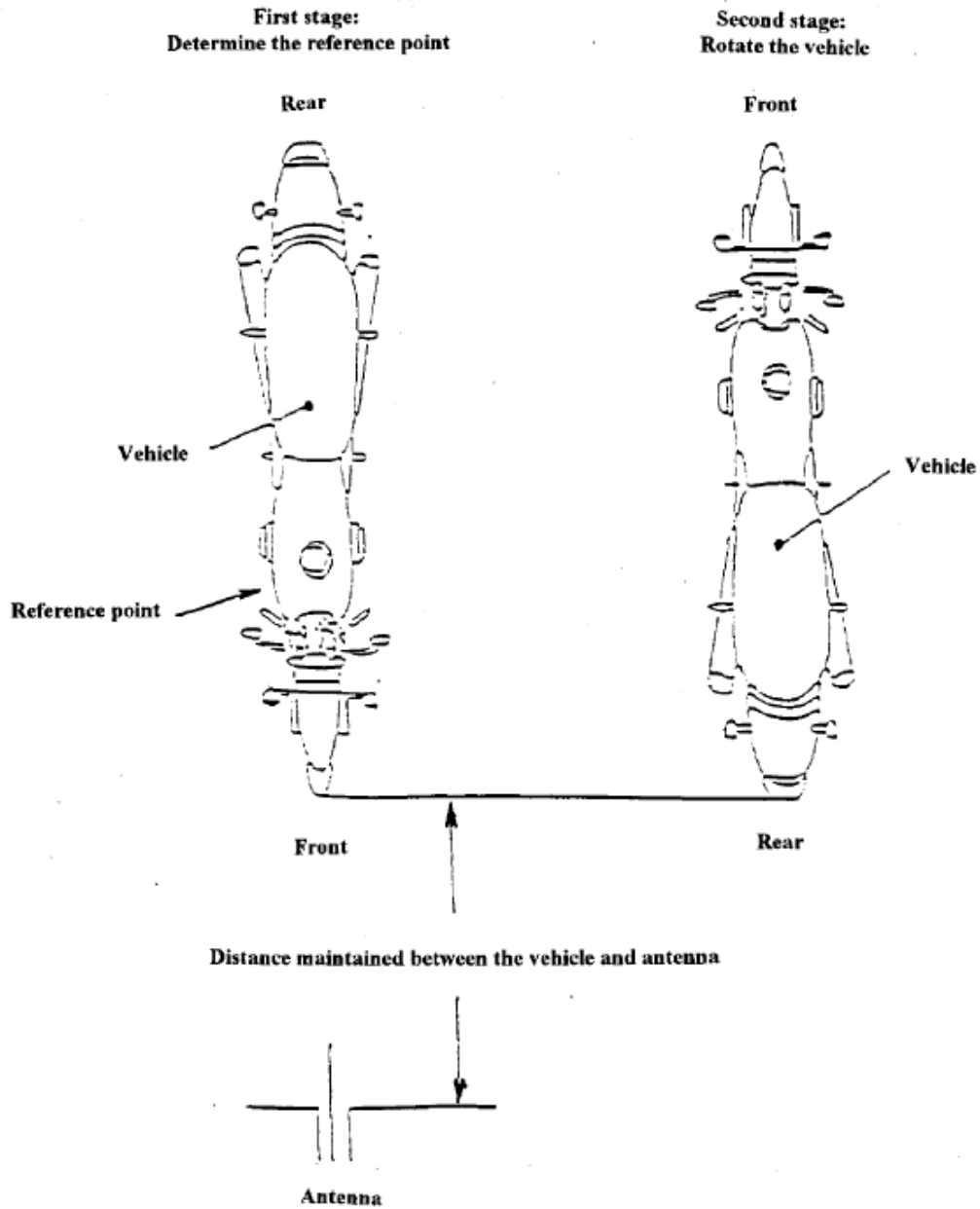




**Figure 2**



**Figure 3**



"Annex 7

**METHOD OF MEASUREMENT OF RADIATED BROADBAND  
ELECTROMAGNETIC EMISSIONS FROM ELECTRICAL/ELECTRONIC SUB-  
ASSEMBLIES**

**1. GENERAL**

**1.1. The test method described in this annex may be applied to ESAs, which may be subsequently fitted to vehicles, which comply, with annex 4.**

**1.2. Test method**

**This test is intended to measure broadband electromagnetic emissions from ESAs (e.g. ignition systems, electric motor etc.).**

**If not otherwise stated in this annex the test shall be performed according CISPR 25 (second edition 2002).**

**2. ESA STATE DURING TESTS**

**2.1. The ESA under test shall be in normal operation mode, preferably in maximum load.**

**3. TEST ARRANGEMENTS**

**3.1. The test shall be performed according to CISPR 25 (second edition 2002) clause 6.4. ALSE method.**

**3.2. Alternative measuring location**

**As an alternative to an absorber lined shielded enclosure (ALSE) an open area test site (OATS), which complies with the requirements of CISPR 16-1 (second edition 2002) may be used (see appendix 1).**

**3.3. Ambient**

**To ensure that there is no extraneous noise or signal of a magnitude sufficient to affect materially the measurement, measurements shall be taken before or after the main test. In this measurement, the extraneous noise or signal shall be at least 6 dB below the limits of interference given in paragraph 6.5.2.1. of this Regulation, except for intentional narrowband ambient transmissions.**

**4. TEST REQUIREMENTS**

**4.1. The limits apply throughout the frequency range 30 to 1,000 MHz for measurements performed in a semi anechoic chamber or an outdoor test site.**

**4.2. Measurements can be performed with either quasi-peak or peak detectors. The limits given in paragraphs 6.2. and 6.5. of this Regulation are for quasi-peak**

detectors. If peak detectors are used a correction factor of 20 dB as defined in CISPR 12 (fifth edition 2001) shall be applied.

#### **4.3. Measurements**

The technical service shall perform the test at the intervals specified in the CISPR 25 (second edition 2002) standard throughout the frequency range 30 to 1,000 MHz.

Alternatively, if the manufacturer provides measurement to data for the whole frequency band from a test laboratory accredited to the applicable parts of ISO 17025 (first edition 1999) and recognized by the Approval Authority, the Technical Service may divide the frequency range in 13 frequency bands 30–50, 50-75, 75-100, 100-130, 130-165, 165-200, 200-250, 250-320, 320-400, 400-520, 520-660, 660-820, 820-1,000 MHz and perform tests at the 13 frequencies giving the highest emission levels within each band to confirm that the ESA meets the requirements of this annex.

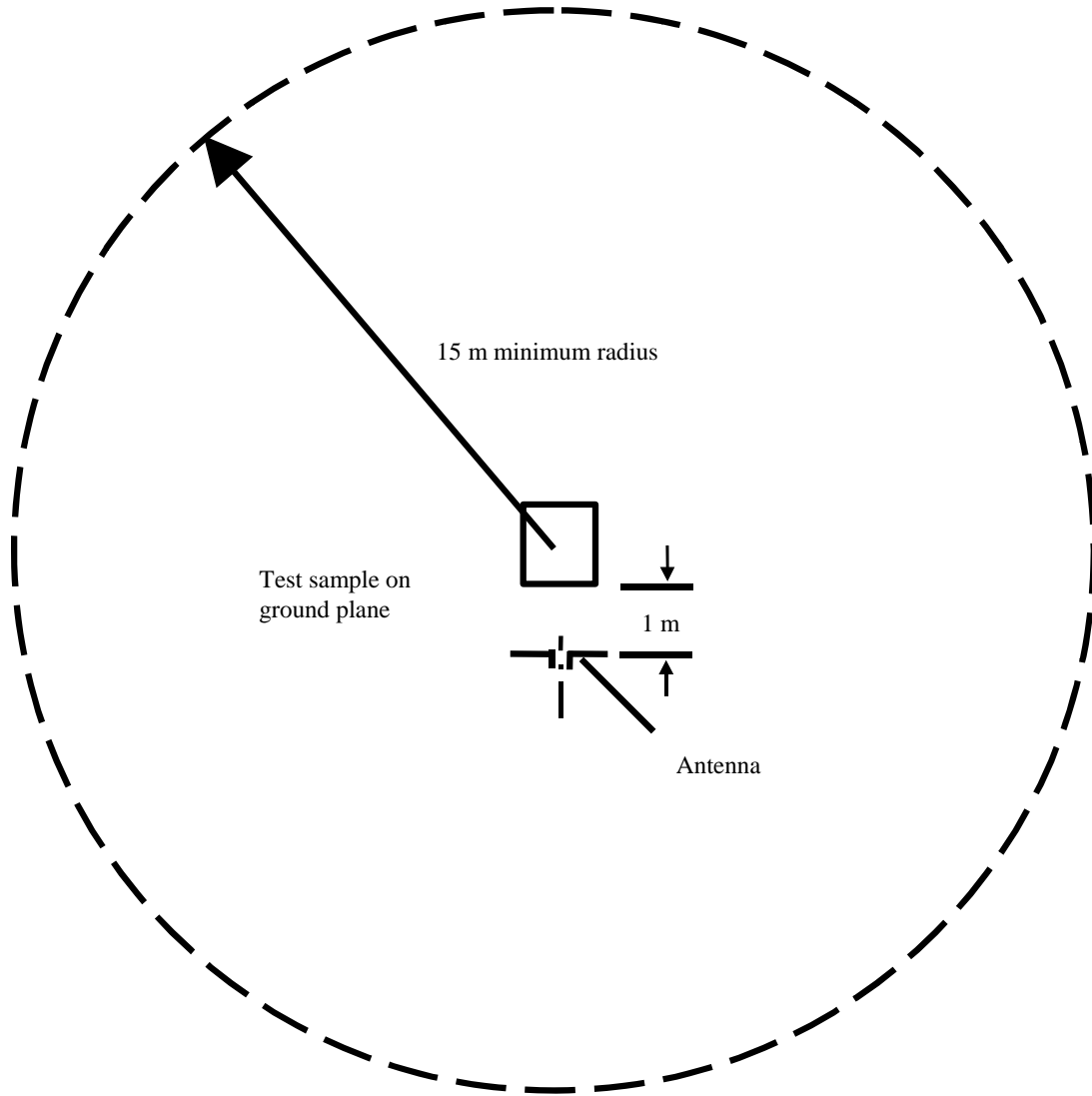
In the event that the limit is exceeded during the test, investigations shall be made to ensure that this is due to the ESA and not to background radiation.

#### **4.4. Readings**

The maximum of the readings relative to the limit (horizontal/vertical polarisation) in each of the 13 frequency bands shall be taken as the characteristic reading at the frequency at which the measurements were made.

**Figure 1**

**Open area test site: Electrical/electronic sub-assembly test area boundary**  
Level clear area free from electromagnetic reflecting surfaces



Annex 8, amend to read:

"Annex 8

**METHOD OF MEASUREMENT OF RADIATED NARROWBAND  
ELECTROMAGNETIC EMISSIONS FROM ELECTRICAL/ELECTRONIC SUB-  
ASSEMBLIES**

**1. GENERAL**

- 1.1. The test method described in this annex may be applied to ESAs, which may be subsequently fitted to vehicles, which comply, with annex 4.**

**1.2. Test method**

**This test is intended to measure the narrowband electromagnetic emissions such as emanate from a microprocessor-base system.**

**If not otherwise stated in this annex the test shall be performed according to CISPR 25 (second edition 2002).**

**2. ESA STATE DURING TESTS**

**The ESA under test shall be in normal operation mode.**

**3. TEST ARRANGEMENTS**

**3.1. The test shall be performed according CISPR 25 (second edition 2002) clause 6.4. ALSE method.**

**3.2. Alternative measuring location**

**As an alternative to an absorber lined shielded enclosure (ALSE) an open area test site (OATS) which complies with the requirements of CISPR 16-1 (second edition 2002) may be used (see appendix 1 to annex 7).**

**3.3. Ambient**

**To ensure that there is no extraneous noise or signal of a magnitude sufficient to affect materially the measurement, measurements shall be taken before or after the main test. In this measurement, the extraneous noise or signal shall be at least 6 dB below the limits of interference given in paragraph 6.5.2.1. of this Regulation, except for intentional narrowband ambient transmissions.**

**4. TEST REQUIREMENTS**

**4.1. The limits apply throughout the frequency range 30 to 1,000 MHz for measurements performed in semi anechoic chambers or outdoor test sites.**

**4.2. Measurements shall be performed with an average detector.**

**4.3. Measurements**

**The technical service shall perform the test at the intervals specified in the CISPR 12 (fifth edition 2001) standard throughout the frequency range 30 to 1,000 MHz.**

**Alternatively, if the manufacturer provides measurement to data for the whole frequency band from a test laboratory accredited to the applicable parts of ISO 17025 (first edition 1999) and recognized by the Approval Authority, the Technical Service may divide the frequency range in 13 frequency bands 30–50, 50-75, 75-100, 100-130, 130-165, 165-200, 200-250, 250-320, 320-400, 400-520, 520-660, 660-820, 820-1,000 MHz and perform tests at the 13 frequencies giving**

the highest emission levels within each band to confirm that the ESA meets the requirements of this annex. In the event that the limit is exceeded during the test, investigations shall be made to ensure that this is due to the ESA and not to background radiation including broadband radiation from the ESA.

#### 4.4. Readings

The maximum of the readings relative to the limit (horizontal/vertical polarisation) in each of the 13 frequency bands shall be taken as the characteristic reading at the frequency at which the measurements were made."

Annex 9, amend to read:

#### "Annex 9

### METHOD(S) OF TESTING FOR IMMUNITY OF ELECTRICAL/ELECTRONIC SUB-ASSEMBLIES TO ELECTROMAGNETIC RADIATION

#### 1. GENERAL

1.1. The test method(s) described in this annex applies to ESAs.

#### 1.2. Test methods

1.2.1. ESAs may comply with the requirements of any combination of the following test methods at the manufacturer's discretion provided that this results in the full frequency range specified in paragraph 3.1. of this annex being covered.

- |                                     |  |
|-------------------------------------|--|
| (a) Absorber chamber test:          | according ISO 11452-2: second edition 2004 |
| (b) TEM cell testing:               | according ISO 11452-3: second edition 2001 |
| (c) Bulk current injection testing: | according ISO 11452-4: third edition 2005  |
| (d) Stripline testing:              | according ISO 11452-5: second edition 2002 |
| (e) 800 mm Stripline:               | according paragraph 4.5. of this annex     |

(Frequency range and general test conditions shall be based on ISO 11452-1: third edition 2005).

#### 2. STATE OF ESA DURING TESTS

2.1. The test conditions shall be according ISO 11452-1: third edition 2005.

2.2. The ESA under test shall be switched on and must be stimulated to be in normal operation condition. It shall be arranged as defined in this annex unless individual test methods dictate otherwise.

2.3. Any extraneous equipment required to operate the ESA under test shall not be in place during the calibration phase. No extraneous equipment shall be closer than 1 m from the reference point during calibration.

2.4. To ensure reproducible measurement results are obtained when tests and measurements are repeated, the test signal generating equipment and its layout

shall be to the same specification as that used during each appropriate calibration phase.

- 2.5. If the ESA under test consists of more than one unit, the interconnecting cables should ideally be the wiring harnesses as intended for use in the vehicle. If these are not available, the length between the electronic control unit and the AN shall be as defined in the standard. All cables in the wiring harness should be terminated as realistically as possible and preferably with real loads and actuators.

### 3. GENERAL TEST REQUIREMENTS

#### 3.1. Frequency range, dwell times

Measurements shall be made in the 20 to 2,000 MHz frequency range with frequency steps according to ISO 11452-1: third edition 2005.

The test signal modulation shall be:

(a) AM, with 1 kHz modulation and 80 per cent modulation depth in the 20 - 800 MHz frequency range,

(b) PM,  $t$  on 577  $\mu$ s, period 4,600  $\mu$ s in the 800 – 2,000 MHz frequency range,

if not otherwise agreed between technical service and ESA manufacturer.

Frequency step size and dwell time shall be chosen according to ISO 11452-1: third edition 2005.

- 3.2. The technical service shall perform the test at the intervals specified in ISO 11452-1: third edition 2005 throughout the frequency range 20 to 2,000 MHz.

Alternatively, if the manufacturer provides measurement to data for the whole frequency band from a test laboratory accredited to the applicable parts of ISO 17025: first edition 1999 and recognized by the Approval Authority, the Technical Service may choose a reduced number of spot frequencies in the range, e.g. 27, 45, 65, 90, 120, 150, 190, 230, 280, 380, 450, 600, 750, 900, 1,300, and 1,800 MHz to confirm that the ESA meets the requirements of this annex.

- 3.3. If an ESA fails the tests defined in this annex, it must be verified as having failed under the relevant test conditions and not as a result of the generation of uncontrolled fields.

### 4. SPECIFIC TEST REQUIREMENTS

#### 4.1. Absorber chamber test

##### 4.1.1. Test method



**This test method allows the testing of vehicle electrical/electronic systems by exposing an ESA to electromagnetic radiation generated by an antenna.**

**4.1.2. Test methodology**

**The "substitution method" shall be used to establish the test field conditions according ISO 11452-2: second edition 2004.**

**The test shall be performed with vertical polarisation.**

**4.2. TEM cell testing**

**4.2.1. Test method**

**The TEM (transverse electromagnetic mode) cell generates homogeneous fields between the internal conductor (septum) and housing (ground plane).**

**4.2.2. Test methodology**

**The test shall be performed according ISO 11452-3: second edition 2001.**

**Depending on the ESA to be tested the Testing Authority shall chose the method of maximum field coupling to the ESA or to the wiring harness inside the TEM-cell.**

**4.3. Bulk current injection testing**

**4.3.1. Test method**

**This is a method of carrying out immunity tests by inducing currents directly into a wiring harness using a current injection probe.**

**4.3.2. Test methodology**

**The test shall be performed according to ISO 11452-4: third edition 2005 on a test bench. As an alternative the ESA may be tested while installed in the vehicle according to ISO 11451-4 (first edition 1995).**

**The injection probe shall positioned in 150 mm distance to the ESA to be tested.**

**The reference method shall be used to calculate injected currents from forward power.**

**The frequency range of the method is limited by the injection probe specification.**

**4.4. Stripline testing**

**4.4.1. Test method**

**This test method consists of subjecting the wiring harness connecting the components in an ESA to specified field strengths.**

**4.4.2. Test methodology**

**The test shall be performed according ISO 11452-5 (second edition 2002).**

**4.5. 800 mm stripline testing**

**4.5.1. Test method**

**The stripline consists of two parallel metallic plates separated by 800 mm. Equipment under test is positioned centrally between the plates and subjected to an electromagnetic field (see appendix 1).**

**This method can test complete electronic systems including sensors and actuators as well as the controller and wiring loom. It is suitable for apparatus whose largest dimension is less than one –third of the plate separation.**

**4.5.2. Test methodology**

**4.5.2.1. Positioning of stripline**

**The stripline shall be housed in a screened room (to prevent external emissions) and positioned 2 m away from walls and any metallic enclosure to prevent electromagnetic reflections. RF absorber material may be used to damp these reflections. The stripline shall be placed on non-conducting supports at least 0.4 m above the floor.**

**4.5.2.2. Calibration of the stripline**

**A field-measuring probe shall be positioned within the central one -third of the longitudinal, vertical and transverse dimensions of the space between the parallel plates with the system under test absent.**

**The associated measuring equipment shall be sited outside the screen room. At each desired test frequency, a level of power shall be fed into the stripline to produce the required field strength at the antenna. This level of forward power, or another parameter directly related to the forward power required to define the field, shall be used for type approval tests unless changes occur in the facilities or equipment, which necessitate this procedure being repeated.**

**4.5.2.3. Installation of the ESA under test**

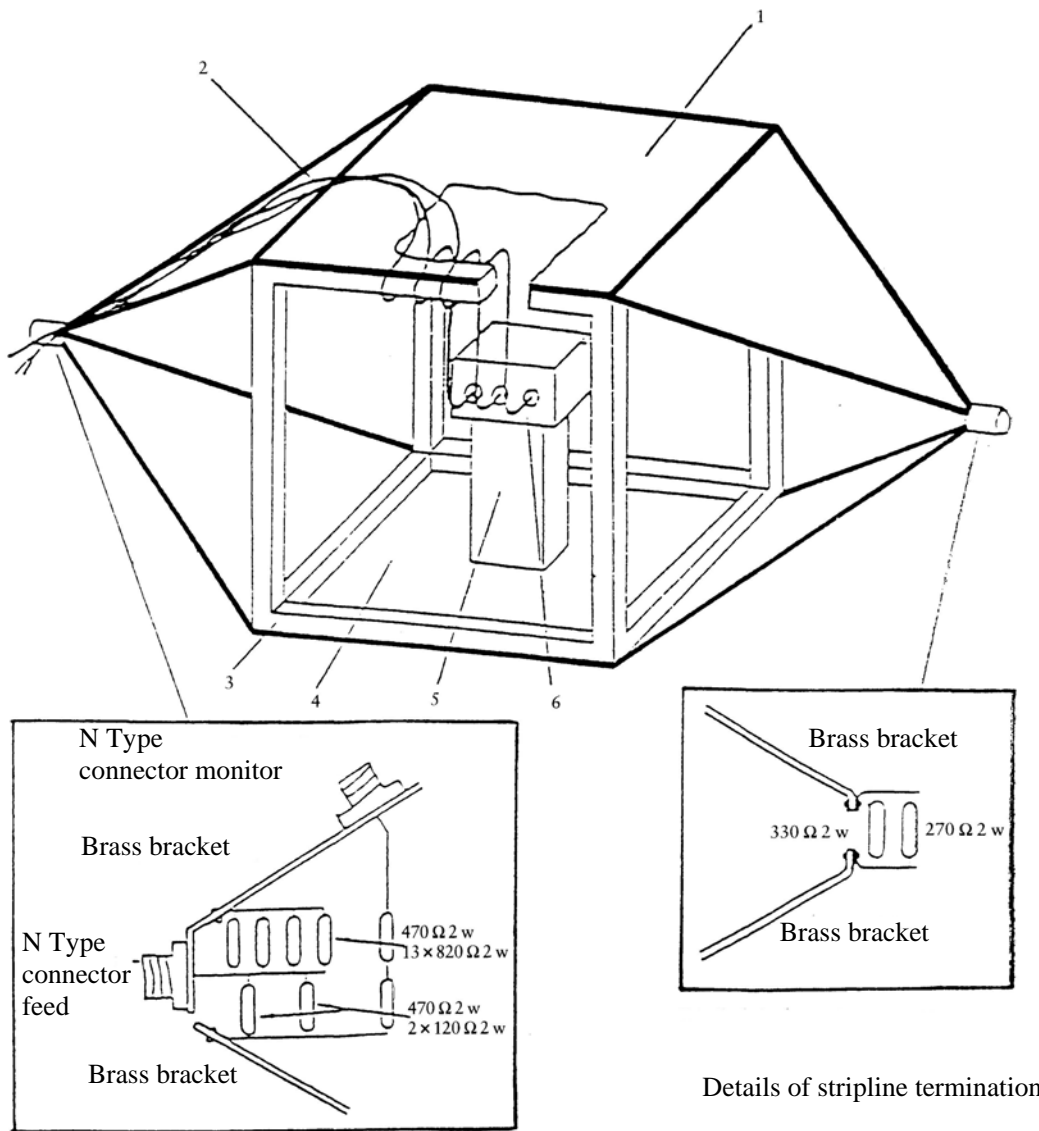
**The main control unit shall be positioned within the central one third of the longitudinal, vertical and transverse dimensions of the space between the parallel plates. It shall be supported on a stand made from non-conducting material.**

**4.5.2.4. Main wiring loom and sensor/actuator cables**

**The main wiring loom and any sensor/actuator cables shall rise vertically from the control unit to the top ground plate (this helps to maximise coupling with the electromagnetic field). Then they shall follow the underside of the plate to one of its free edges where they shall loop over and follow the top of the ground plate as far as the connections to the stripline feed. The cables shall then be routed to the associated equipment, which shall be sited in an area outside the influence of the electromagnetic field, e.g.: on the floor of the screened room 1 m longitudinally away from the stripline.**

**Figure 1**

800 mm Stripline testing



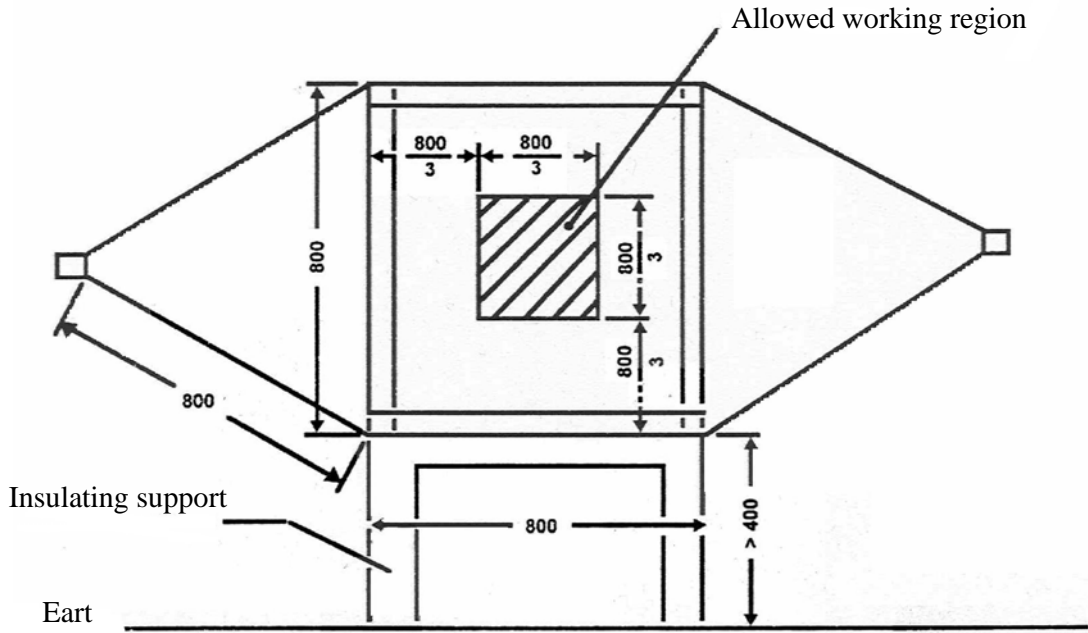
Details of stripline feed

Details of stripline termination

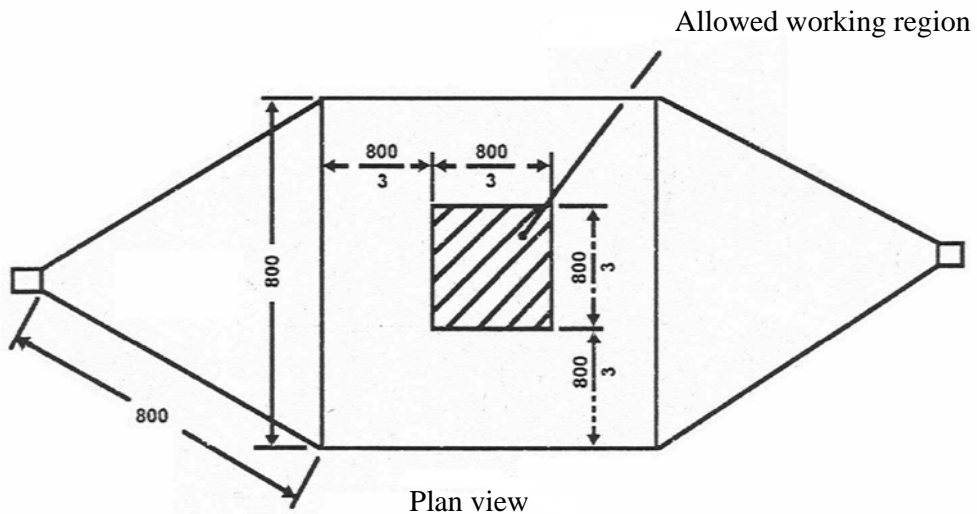
- 1 = Ground plate
- 2 = Main loom and sensor/actuator cables
- 3 = Wooden frame
- 4 = Driven plate
- 5 = Insulator
- 6 = Test object

Figure 2

800 mm Stripline dimensions



Side view



Plan view

All dimensions in millimetres

**Typical TEM cell dimensions**

The following table shows **the dimensions for constructing a cell with specified upper frequency limits:**

Upper frequency (MHz)	Cell form factor W : b	Cell form factor L/W	Plate separation b (cm)	Septum S (cm)
200	1.69	0.66	56	70
200	1.00	1	60	50

..

Insert a new annex 10, to read:

**"Annex 10**

**METHOD(S) OF TESTING FOR IMMUNITY TO AND EMISSION OF TRANSIENTS OF ELECTRICAL/ELECTRONIC SUB-ASSEMBLIES**

- 1. General**  
This test method shall ensure the immunity of ESAs to conducted transients on the vehicle power supply and limit conducted transients from ESAs to the vehicle power supply.
- 2. Immunity against disturbances conducted along supply lines**  
Apply the test pulses 1, 2a, 2b, 3a 3b and 4 according to the International Standard ISO 7637-2: 2004 to the supply lines as well as to other connections of ESAs which may be operationally connected to supply lines.
- 3. Emission of conducted disturbances along supply lines**  
Measurement according to the International Standard ISO 7637-2: 2004 on supply lines as well as to other connections of ESAs which may be operationally connected to supply lines."

**A. JUSTIFICATION**

The use of electrical and electronic systems in motor vehicles has increased tremendously in recent years. In addition to the far-reaching use of information and entertainment devices and an increasing number of electric motors and electronic devices, even certain safety functions are now controlled by electrical and electronic components (e.g. stability control, airbags). In order to ensure the safe functioning of modern motor vehicles and in view of the rapid technical developments in this area, it is necessary to amend the Regulation.

The electromagnetic compatibility (EMC) requirements and test provisions for electrical and electronic equipment have constantly been updated through the standardisation work of the International Special Committee on Radio Interference (CISPR) and the International Organisation for Standardisation (ISO). It is therefore appropriate to refer in this Regulation to the test procedures outlined in the recent editions of the relevant standards. It is also necessary to clarify the scope of this Regulation, in particular for after-market products.