

PART 5

CONSIGNMENT PROCEDURES

CHAPTER 5.1

GENERAL PROVISIONS

5.1.1 Application and general provisions

5.1.1.1 This Part sets forth the provisions for dangerous goods consignments relative to authorization of consignments and advance notifications, marking, labelling, documentation (by manual, electronic data processing (EDP) or electronic data interchange (EDI) techniques) and placarding.

5.1.1.2 Except as otherwise provided in these Regulations, no person may offer dangerous goods for transport unless those goods are properly marked, labelled, placarded, described and certified on a transport document, and otherwise in a condition for transport as required by this Part.

5.1.2 Use of overpacks

5.1.2.1 An overpack shall be marked with the word "OVERPACK", with the proper shipping name and the UN number and labelled, as required for packages by Chapter 5.2, for each item of dangerous goods contained in the overpack unless markings and labels representative of all dangerous goods in the overpack are visible, except as required in 5.2.2.1.12. The lettering of the "OVERPACK" marking shall be at least 12 mm high.

NOTE: *The size requirement for the "OVERPACK" marking shall apply as from 1 January 2016.*

5.1.2.2 Each package of dangerous goods contained in the overpack shall comply with all applicable provisions of these Regulations. The "overpack" marking is an indication of compliance with this requirement. The intended function of each package shall not be impaired by the overpack.

5.1.2.3 Each package bearing package orientation markings as prescribed in 5.2.1.7 of these Regulations and which is overpacked or placed in a large packaging shall be oriented in accordance with such markings.

5.1.3 Empty packagings

5.1.3.1 Other than for Class 7, a packaging which previously contained dangerous goods shall be identified, marked, labelled and placarded as required for those dangerous goods unless steps such as cleaning, purging of vapours or refilling with a non-dangerous substance are taken to nullify any hazard.

5.1.3.2 Freight containers, tanks, IBCs, as well as other packagings and overpacks, used for the transport of radioactive material shall not be used for the storage or transport of other goods unless decontaminated below the level of 0.4 Bq/cm² for beta and gamma emitters and low toxicity alpha emitters and 0.04 Bq/cm² for all other alpha emitters.

5.1.4 Mixed packing

When two or more dangerous goods are packed within the same outer packaging, the package shall be labelled and marked as required for each substance. Subsidiary risk labels need not be applied if the hazard is already represented by a primary risk label.

5.1.5 General provisions for Class 7

5.1.5.1 *Approval of shipments and notification*

5.1.5.1.1 *General*

In addition to the approval of package designs described in Chapter 6.4, multilateral shipment approval is also required in certain circumstances (5.1.5.1.2 and 5.1.5.1.3). In some circumstances it is also necessary to notify competent authorities of a shipment (5.1.5.1.4).

5.1.5.1.2 *Shipment approvals*

Multilateral approval shall be required for:

- (a) The shipment of Type B(M) packages not conforming to the requirements of 6.4.7.5 or designed to allow controlled intermittent venting;
- (b) The shipment of Type B(M) packages containing radioactive material with an activity greater than 3 000 A₁ or 3 000 A₂, as appropriate, or 1 000 TBq, whichever is the lower;
- (c) The shipment of packages containing fissile materials if the sum of the criticality safety indexes of the packages in a single freight container or in a single conveyance exceeds 50. Excluded from this requirement shall be shipments by seagoing vessels, if the sum of the criticality safety indexes does not exceed 50 for any hold, compartment or defined deck area and the distance of 6 m between groups of packages or overpacks as required in table 7.1.8.4.2 is met; and
- (d) Radiation protection programmes for shipments by special use vessels in accordance with 7.2.3.2.2;

except that a competent authority may authorize transport into or through its country without shipment approval, by a specific provision in its design approval (see 5.1.5.2.1).

5.1.5.1.3 *Shipment approval by special arrangement*

Provisions may be approved by a competent authority under which a consignment, which does not satisfy all of the applicable requirements of these Regulations may be transported under special arrangement (see 1.1.2.4).

5.1.5.1.4 *Notifications*

Notification to competent authorities is required as follows:

- (a) Before the first shipment of any package requiring competent authority approval, the consignor shall ensure that copies of each applicable competent authority certificate applying to that package design have been submitted to the competent authority of the country of origin of the shipment and to the competent authority of each country through or into which the consignment is to be transported. The consignor is not required to await an acknowledgement from the competent authority, nor is the competent authority required to make such acknowledgement of receipt of the certificate;
- (b) For each of the following types of shipments:
 - (i) Type C packages containing radioactive material with an activity greater than 3 000 A₁ or 3 000 A₂, as appropriate, or 1 000 TBq, whichever is the lower;

- (ii) Type B(U) packages containing radioactive material with an activity greater than 3 000 A₁ or 3 000 A₂, as appropriate, or 1 000 TBq, whichever is the lower;
- (iii) Type B(M) packages;
- (iv) Shipment under special arrangement,

the consignor shall notify the competent authority of the country of origin of the shipment and the competent authority of each country through or into which the consignment is to be transported. This notification shall be in the hands of each competent authority prior to the commencement of the shipment, and preferably at least 7 days in advance;

- (c) The consignor is not required to send a separate notification if the required information has been included in the application for approval of shipment (see 6.4.23.2);
- (d) The consignment notification shall include:
 - (i) sufficient information to enable the identification of the package or packages including all applicable certificate numbers and identification marks;
 - (ii) information on the date of shipment, the expected date of arrival and proposed routing;
 - (iii) the names of the radioactive material or nuclides;
 - (iv) descriptions of the physical and chemical forms of the radioactive material, or whether it is special form radioactive material or low dispersible radioactive material; and
 - (v) the maximum activity of the radioactive contents during transport expressed in units of becquerels (Bq) with an appropriate SI prefix symbol (see 1.2.2.1). For fissile material, the mass of fissile material (or of each fissile nuclide for mixtures when appropriate) in units of grams (g), or multiples thereof, may be used in place of activity.

5.1.5.2 *Certificates issued by Competent Authority*

5.1.5.2.1 Certificates issued by the competent authority are required for the following:

- (a) Designs for
 - (i) special form radioactive material;
 - (ii) low dispersible radioactive material;
 - (iii) fissile material excepted under 2.7.2.3.5 (f);
 - (iv) packages containing 0.1 kg or more of uranium hexafluoride;
 - (v) packages containing fissile material unless excepted by 2.7.2.3.5, 6.4.11.2 or 6.4.11.3;
 - (vi) Type B(U) packages and Type B(M) packages;
 - (vii) Type C packages;

- (b) Special arrangements;
- (c) Certain shipments (see 5.1.5.1.2);
- (d) Determination of the basic radionuclide values referred to in 2.7.2.2.1 for individual radionuclides which are not listed in Table 2.7.2.2.1 (see 2.7.2.2.2 (a));
- (e) Alternative activity limits for an exempt consignment of instruments or articles (see 2.7.2.2.2 (b));

The certificates shall confirm that the applicable requirements are met, and for design approvals shall attribute to the design an identification mark.

The certificates of approval for the package design and the shipment may be combined into a single certificate.

Certificates and applications for these certificates shall be in accordance with the requirements in 6.4.23.

5.1.5.2.2 The consignor shall be in possession of a copy of each applicable certificate.

5.1.5.2.3 For package designs where it is not required that a competent authority issue a certificate of approval, the consignor shall, on request, make available for inspection by the relevant competent authority, documentary evidence of the compliance of the package design with all the applicable requirements.

5.1.5.3 *Determination of transport index (TI) and criticality safety index (CSI)*

5.1.5.3.1 The transport index (TI) for a package, overpack or freight container, or for unpackaged LSA-I or SCO-I, shall be the number derived in accordance with the following procedure:

- (a) Determine the maximum radiation level in units of millisieverts per hour (mSv/h) at a distance of 1 m from the external surfaces of the package, overpack, freight container, or unpackaged LSA-I and SCO-I. The value determined shall be multiplied by 100 and the resulting number is the transport index. For uranium and thorium ores and their concentrates, the maximum radiation level at any point 1 m from the external surface of the load may be taken as:
 - 0.4 mSv/h for ores and physical concentrates of uranium and thorium;
 - 0.3 mSv/h for chemical concentrates of thorium;
 - 0.02 mSv/h for chemical concentrates of uranium, other than uranium hexafluoride;
- (b) For tanks, freight containers and unpackaged LSA-I and SCO-I, the value determined in step (a) above shall be multiplied by the appropriate factor from Table 5.1.5.3.1;
- (c) The value obtained in steps (a) and (b) above shall be rounded up to the first decimal place (e.g. 1.13 becomes 1.2), except that a value of 0.05 or less may be considered as zero.

Table 5.1.5.3.1: Multiplication factors for tanks, freight containers and unpackaged LSA-I and SCO-I

Size of load ^a	Multiplication factor
size of load $\leq 1 \text{ m}^2$	1
$1 \text{ m}^2 < \text{size of load} \leq 5 \text{ m}^2$	2
$5 \text{ m}^2 < \text{size of load} \leq 20 \text{ m}^2$	3
$20 \text{ m}^2 < \text{size of load}$	10

^a Largest cross-sectional area of the load being measured.

5.1.5.3.2 The transport index for each overpack, freight container or conveyance shall be determined as either the sum of the TIs of all the packages contained, or by direct measurement of radiation level, except in the case of non-rigid overpacks for which the transport index shall be determined only as the sum of the TIs of all the packages.

5.1.5.3.3 The criticality safety index for each overpack or freight container shall be determined as the sum of the CSIs of all the packages contained. The same procedure shall be followed for determining the total sum of the CSIs in a consignment or aboard a conveyance.

5.1.5.3.4 Packages, overpacks and freight containers shall be assigned to either category I-WHITE, II-YELLOW or III-YELLOW in accordance with the conditions specified in Table 5.1.5.3.4 and with the following requirements:

- (a) For a package, overpack or freight container, both the transport index and the surface radiation level conditions shall be taken into account in determining which is the appropriate category. Where the transport index satisfies the condition for one category but the surface radiation level satisfies the condition for a different category, the package, overpack or freight container shall be assigned to the higher category. For this purpose, category I-WHITE shall be regarded as the lowest category;
- (b) The transport index shall be determined following the procedures specified in 5.1.5.3.1 and 5.1.5.3.2;
- (c) If the surface radiation level is greater than 2 mSv/h, the package or overpack shall be transported under exclusive use and under the provisions of 7.2.3.1.3, 7.2.3.2.1, or 7.2.3.3.3, as appropriate;
- (d) A package transported under a special arrangement shall be assigned to category III-YELLOW except under the provisions of 5.1.5.3.5;
- (e) An overpack or freight container which contains packages transported under special arrangement shall be assigned to category III-YELLOW except under the provisions of 5.1.5.3.5.

Table 5.1.5.3.4: Categories of packages, overpacks and freight containers

Conditions		
Transport index	Maximum radiation level at any point on external surface	Category
0 ^a	Not more than 0.005 mSv/h	I-WHITE
More than 0 but not more than 1 ^a	More than 0.005 mSv/h but not more than 0.5 mSv/h	II-YELLOW
More than 1 but not more than 10	More than 0.5 mSv/h but not more than 2 mSv/h	III-YELLOW
More than 10	More than 2 mSv/h but not more than 10 mSv/h	III-YELLOW ^b

^a If the measured TI is not greater than 0.05, the value quoted may be zero in accordance with 5.1.5.3.1(c).

^b Shall also be transported under exclusive use except for freight containers (see Table 7.1.8.3.3).

5.1.5.3.5 In all cases of international transport of packages requiring competent authority approval of design or shipment, for which different approval types apply in the different countries concerned by the shipment, the categorization shall be in accordance with the certificate of the country of origin of design.

5.1.5.4 *Specific provisions for excepted packages of radioactive material of Class 7*

5.1.5.4.1 Excepted packages of radioactive material of Class 7 shall be legibly and durably marked on the outside of the packaging with:

- (a) The UN number preceded by the letters “UN”;
- (b) An identification of either the consignor or consignee, or both; and
- (c) The permissible gross mass if this exceeds 50 kg.

5.1.5.4.2 The documentation requirements of Chapter 5.4 do not apply to excepted packages of radioactive material of Class 7, except that:

- (a) The UN number preceded by the letters “UN” and the name and address of the consignor and the consignee and, if relevant, the identification mark for each competent authority certificate of approval (see 5.4.1.5.7.1 (g)) shall be shown on a transport document such as a bill of lading, air waybill or other similar document complying with the requirements of 5.4.1.2.1 to 5.4.1.2.4;
- (b) The requirements of 5.4.1.6.2 and, if relevant, those of 5.4.1.5.7.1 (g), 5.4.1.5.7.3 and 5.4.1.5.7.4 shall apply;
- (c) The requirements of 5.4.2 and 5.4.4 shall apply.

5.1.5.4.3 The requirements of 5.2.1.5.8 and 5.2.2.1.12.5 shall apply if relevant.

CHAPTER 5.2

MARKING AND LABELLING

5.2.1 Marking

5.2.1.1 Unless provided otherwise in these Regulations, the proper shipping name for the dangerous goods as determined in accordance with 3.1.2 and the corresponding UN number preceded by the letters "UN", shall be displayed on each package. The UN number and the letters "UN" shall be at least 12 mm high, except for packages of 30 litres capacity or less or of 30 kg maximum net mass and for cylinders of 60 litres water capacity when they shall be at least 6 mm in height and except for packages of 5 litres or 5 kg or less when they shall be of an appropriate size. In the case of unpackaged articles the marking shall be displayed on the article, on its cradle or on its handling, storage or launching device. For goods of Division 1.4, Compatibility Group S, the division and compatibility group letter shall also be marked unless the label for 1.4S is displayed. A typical package marking is:

Corrosive liquid, acidic, organic, n.o.s. (Caprylyl chloride) UN 3265.

NOTE: *The size requirements for the UN number marking shall apply as from 1 January 2014.*

5.2.1.2 All package markings required by 5.2.1.1:

- (a) Shall be readily visible and legible;
- (b) Shall be able to withstand open weather exposure without a substantial reduction in effectiveness;
- (c) Shall be displayed on a background of contrasting colour on the external surface of the package; and
- (d) Shall not be located with other package markings that could substantially reduce their effectiveness.

5.2.1.3 Salvage packagings and salvage pressure receptacles shall additionally be marked with the word "SALVAGE". The lettering of the "SALVAGE" marking shall be at least 12 mm high.

NOTE: *The size requirement for the "SALVAGE" marking shall apply as from 1 January 2016.*

5.2.1.4 Intermediate bulk containers of more than 450 litres capacity and large packagings shall be marked on two opposing sides.

5.2.1.5 *Special marking provisions for radioactive material*

5.2.1.5.1 Each package shall be legibly and durably marked on the outside of the packaging with an identification of either the consignor or consignee, or both. Each overpack shall be legibly and durably marked on the outside of the overpack with an identification of either the consignor or consignee, or both unless these markings of all packages within the overpack are clearly visible.

5.2.1.5.2 The marking of excepted packages of radioactive material of Class 7 shall be as required by 5.1.5.4.1.

5.2.1.5.3 Each package of gross mass exceeding 50 kg shall have its permissible gross mass legibly and durably marked on the outside of the packaging.

5.2.1.5.4 Each package which conforms to:

- (a) a Type IP-1 package, a Type IP-2 package or a Type IP-3 package design shall be legibly and durably marked on the outside of the packaging with "TYPE IP-1", "TYPE IP-2" or "TYPE IP-3" as appropriate;
- (b) a Type A package design shall be legibly and durably marked on the outside of the packaging with "TYPE A";
- (c) a Type IP-2 package, a Type IP-3 or a Type A package design shall be legibly and durably marked on the outside of the packaging with the international vehicle registration code (VRI Code) of the country of origin of design and either the name of the manufacturer or other identification of the packaging specified by the competent authority of the country of origin of design.

5.2.1.5.5 Each package which conforms to a design approved under one or more of paragraphs 5.1.5.2.1, 6.4.22.1 to 6.4.22.4, 6.4.23.4 to 6.4.23.7 and 6.4.24.2 shall be legibly and durably marked on the outside of the packaging with the following information:

- (a) the identification mark allocated to that design by the competent authority;
- (b) a serial number to uniquely identify each packaging which conforms to that design;
- (c) Type B(U)", "Type B(M)" or "Type C", in the case of a Type B(U), Type B(M) or Type C package design.

5.2.1.5.6 Each package which conforms to a Type B(U), Type B(M) or Type C package design shall have the outside of the outermost receptacle which is resistant to the effects of fire and water plainly marked by embossing, stamping or other means resistant to the effects of fire and water with the trefoil symbol shown in the figure below:

Figure 5.2.1

Basic trefoil symbol with proportions based on a central circle of radius X .
The minimum allowable size of X shall be 4 mm.

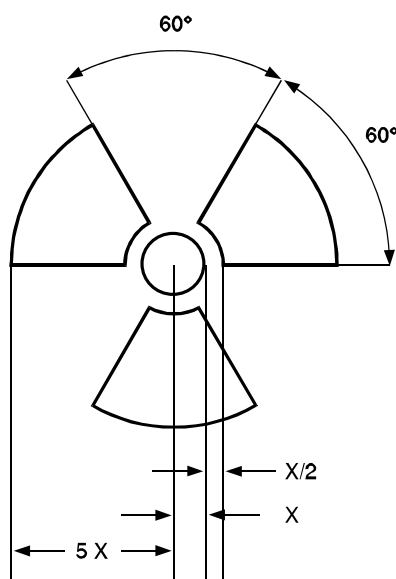

5.2.1.5.7 Where LSA-I or SCO-I material is contained in receptacles or wrapping materials and is transported under exclusive use as permitted by 4.1.9.2.4, the outer surface of these receptacles or wrapping materials may bear the marking “RADIOACTIVE LSA-I” or “RADIOACTIVE SCO-I”, as appropriate.

5.2.1.5.8 In all cases of international transport of packages requiring competent authority approval of design or shipment, for which different approval types apply in the different countries concerned by the shipment, marking shall be in accordance with the certificate of the country of origin of the design.

5.2.1.6 *Special marking provisions for environmentally hazardous substances*

5.2.1.6.1 Unless otherwise specified in these Regulations, packages containing environmentally hazardous substances meeting the criteria of 2.9.3 (UN Nos. 3077 and 3082) shall be durably marked with the environmentally hazardous substance mark.

5.2.1.6.2 The environmentally hazardous substance mark shall be located adjacent to the markings required by 5.2.1.1. The requirements of 5.2.1.2 and 5.2.1.4 shall be met.

5.2.1.6.3 The environmentally hazardous substance mark shall be as shown in Figure 5.2.2.

Figure 5.2.2



Environmentally hazardous substance mark

The marking shall be in the form of a square set at an angle of 45 degrees (diamond-shaped). The symbol (fish and tree) shall be black on white or suitable contrasting background. The minimum dimensions shall be 100 mm x 100 mm and the minimum width of line forming the diamond shall be 2 mm. If the size of the package so requires, the dimensions/line thickness may be reduced, provided the marking remains clearly visible. Where dimensions are not specified, all features shall be in approximate proportion to those shown.

NOTE 1: *The labelling provisions of 5.2.2 apply in addition to any requirement for packages to bear the environmentally hazardous substance mark.*

NOTE 2: *The provisions of 5.2.1.6.3 from the seventeenth revised edition of the Recommendations on the Transport of Dangerous Goods, Model Regulations may continue to be applied until 31 December 2016.*

5.2.1.7 *Orientation arrows*

5.2.1.7.1 Except as provided in 5.2.1.7.2:

- combination packagings having inner packagings containing liquid dangerous goods;
- single packagings fitted with vents; and
- cryogenic receptacles intended for the transport of refrigerated liquefied gases,

shall be legibly marked with package orientation arrows which are similar to the illustration shown below or with those meeting the specifications of ISO 780:1997. The orientation arrows shall appear on two opposite vertical sides of the package with the arrows pointing in the correct upright direction. They shall be rectangular and of a size that is clearly visible commensurate with the size of the package. Depicting a rectangular border around the arrows is optional.

Figure 5.2.3

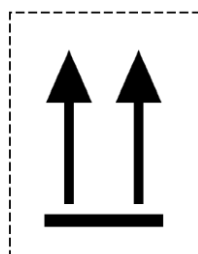
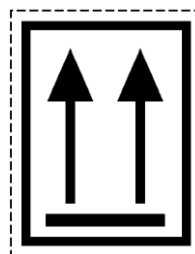

Figure 5.2.4



or

Two black or red arrows on white or suitable contrasting background.

The rectangular border is optional

All features shall be in approximate proportion to those shown.

5.2.1.7.2 Orientation arrows are not required on:

- (a) Outer packagings containing pressure receptacles except cryogenic receptacles;
- (b) Outer packagings containing dangerous goods in inner packagings each containing not more than 120 ml, with sufficient absorbent material between the inner and outer packagings to completely absorb the liquid contents;
- (c) Outer packagings containing division 6.2 infectious substances in primary receptacles each containing not more than 50 ml;
- (d) Type IP-2, type IP-3, type A, type B(U), type B(M) or type C packages containing Class 7 radioactive material;
- (e) Outer packagings containing articles which are leak-tight in all orientations (e.g. alcohol or mercury in thermometers, aerosols, etc.); or
- (f) Outer packagings containing dangerous goods in hermetically sealed inner packagings each containing not more than 500 ml.

5.2.1.7.3 Arrows for purposes other than indicating proper package orientation shall not be displayed on a package marked in accordance with this sub-section.

5.2.1.8 *Excepted quantities mark*

to 3.5.4. Packages containing excepted quantities of dangerous goods shall be marked according

5.2.2 Labelling

5.2.2.1 Labelling provisions

NOTE: *These provisions relate essentially to danger labels. However, additional markings or symbols indicating precautions to be taken in handling or storing a package (e.g. a symbol representing an umbrella indicating that a package shall be kept dry) may be displayed on a package if appropriate.*

5.2.2.1.1 Labels identifying primary and subsidiary risks shall conform to models Nos. 1 to 9 illustrated in 5.2.2.2.2. The “EXPLOSIVE” subsidiary risk label is model No. 1.

5.2.2.1.2 Where articles or substances are specifically listed in the Dangerous Goods List, a danger class label shall be affixed for the hazard shown in Column 3. A subsidiary risk label shall also be affixed for any risk indicated by a class or division number in the Column 4 of the Dangerous Goods List. However, special provisions indicated in Column 6 may also require a subsidiary risk label where no subsidiary risk is indicated in Column 4 or may exempt from the requirement for a subsidiary risk label where such a risk is indicated in the Dangerous Goods List.

5.2.2.1.3 Except as provided in 5.2.2.1.3.1, if a substance which meets the definition of more than one class is not specifically listed by name in the Dangerous Goods List in Chapter 3.2, the provisions in Chapter 2.0 shall be used to determine the primary risk class of the goods. In addition to the label required for that primary risk class, subsidiary risk labels shall also be applied as specified in the Dangerous Goods List.

5.2.2.1.3.1 Packages containing substances of Class 8 need not bear subsidiary risk label model No. 6.1 if the toxicity arises solely from the destructive effect on tissue. Packages containing substances of Division 4.2 need not bear subsidiary risk label model No. 4.1.

5.2.2.1.4 Labels for Class 2 gases with subsidiary risk(s)

Division	Subsidiary risk(s) shown in Chapter 2.2	Primary risk label	Subsidiary risk label(s)
2.1	None	2.1	None
2.2	None	2.2	None
	5.1	2.2	5.1
2.3	None	2.3	None
	2.1	2.3	2.1
	5.1	2.3	5.1
	5.1, 8	2.3	5.1, 8
	8	2.3	8
	2.1, 8	2.3	2.1, 8

5.2.2.1.5 Three separate labels have been provided for Class 2, one for flammable gases of Division 2.1 (red), one for non-flammable, non-toxic gases of Division 2.2 (green) and one for toxic gases of Division 2.3 (white). Where the Dangerous Goods List indicates that a Class 2 gas possesses single or multiple subsidiary risks, labels shall be used in accordance with the table in 5.2.2.1.4.

5.2.2.1.6 Except as provided in 5.2.2.2.1.2, each label shall:

- (a) Be located on the same surface of the package near the proper shipping name marking, if the package dimensions are adequate;

- (b) Be so placed on the packaging that they are not covered or obscured by any part or attachment to the packaging or any other label or marking; and
- (c) When primary and subsidiary risk labels are required, be displayed next to each other.

Where a package is of such an irregular shape or small size that a label cannot be satisfactorily affixed, the label may be attached to the package by a securely affixed tag or other suitable means.

5.2.2.1.7 Intermediate bulk containers of more than 450 litres capacity and large packagings shall be labelled on two opposing sides.

5.2.2.1.8 Labels shall be affixed on a surface of contrasting colour.

5.2.2.1.9 *Special provisions for the labelling of self-reactive substances*

An “EXPLOSIVE” subsidiary risk label (Model No. 1) shall be applied for type B self-reactive substances, unless the competent authority has permitted this label to be dispensed with for a specific packaging because test data have proved that the self-reactive substance in such a packaging does not exhibit explosive behaviour.

5.2.2.1.10 *Special provisions for the labelling of organic peroxides*

The Division 5.2 label (model No. 5.2) shall be affixed to packages containing organic peroxides classified as types B, C, D, E or F. This label also implies that the product may be flammable and hence no “FLAMMABLE LIQUID”, subsidiary risk label (model No. 3) is required. In addition, the following subsidiary risk labels shall be applied:

- (a) An “EXPLOSIVE” subsidiary risk label (model No. 1) for organic peroxides type B, unless the competent authority has permitted this label to be dispensed with for a specific packaging because test data have proved that the organic peroxide in such a packaging does not exhibit explosive behaviour;
- (b) A “CORROSIVE” subsidiary risk label (model No. 8) is required when packing group I or II criteria of Class 8 are met.

5.2.2.1.11 *Special provisions for the labelling of infectious substances packages*

In addition to the primary risk label (model No. 6.2), infectious substances packages shall bear any other label required by the nature of the contents.

5.2.2.1.12 *Special provisions for the labelling of radioactive material*

5.2.2.1.12.1 Except when enlarged labels are used in accordance with 5.3.1.1.5.1, each package, overpack and freight container containing radioactive material shall bear the labels conforming to the applicable models Nos. 7A, 7B or 7C, according to the appropriate category. Labels shall be affixed to two opposite sides on the outside of the package or overpack or on the outside of all four sides of a freight container or tank. Each overpack containing radioactive material shall bear at least two labels on opposite sides of the outside of the overpack. In addition, each package, overpack and freight container containing fissile material, other than fissile material excepted under the provisions of 2.7.2.3.5 shall bear labels conforming to model No. 7E; such labels, where applicable shall be affixed adjacent to the labels conforming to the applicable model Nos. 7A, 7B or 7C.. Labels shall not cover the markings specified in 5.2.1. Any labels which do not relate to the contents shall be removed or covered.

5.2.2.1.12.2 Each label conforming to the applicable model No. 7A, 7B or 7C shall be completed with the following information:

- (a) Contents:
 - (i) except for LSA-I material, the name(s) of the radionuclide(s) as taken from Table 2.7.2.2.1, using the symbols prescribed therein. For mixtures of radionuclides, the most restrictive nuclides shall be listed to the extent the space on the line permits. The group of LSA or SCO shall be shown following the name(s) of the radionuclide(s). The terms “LSA-II”, “LSA-III”, “SCO-I” and “SCO-II” shall be used for this purpose;
 - (ii) for LSA-I material, the term “LSA-I” is all that is necessary; the name of the radionuclide is not necessary;
- (b) Activity: The maximum activity of the radioactive contents during transport expressed in units of becquerels (Bq) with the appropriate SI prefix symbol (see 1.2.2.1). For fissile material, the total mass of fissile nuclides in units of grams (g), or multiples thereof, may be used in place of activity;
- (c) For overpacks and freight containers the “contents” and “activity” entries on the label shall bear the information required in 5.2.2.1.12.2 (a) and 5.2.2.1.12.2 (b), respectively, totalled together for the entire contents of the overpack or freight container except that on labels for overpacks or freight containers containing mixed loads of packages containing different radionuclides, such entries may read “See Transport Documents”;
- (d) Transport index: The number determined in accordance with 5.1.5.3.1 and 5.1.5.3.2 (no transport index entry is required for category I-WHITE).

5.2.2.1.12.3 Each label conforming to the model No. 7E shall be completed with the criticality safety index (CSI) as stated in the certificate of approval applicable in the countries through or into which the consignment is transported and issued by the competent authority or as specified in 6.4.11.2 or 6.4.11.3.

5.2.2.1.12.4 For overpacks and freight containers, the label conforming to model No. 7E shall bear the sum of the criticality safety indexes of all the packages contained therein.

5.2.2.1.12.5 In all cases of international transport of packages requiring competent authority approval of design or shipment, for which different approval types apply in the different countries concerned by the shipment, labelling shall be in accordance with the certificate of the country of origin of design.

5.2.2.2 Provisions for labels

5.2.2.2.1 Labels shall satisfy the provisions of this section and conform, in terms of colour, symbols and general format, to the specimen labels shown in 5.2.2.2.2.

NOTE: *Where appropriate, labels in 5.2.2.2.2 are shown with a dotted outer boundary as provided for in 5.2.2.2.1.1. This is not required when the label is applied on a background of contrasting colour.*

5.2.2.2.1.1 Labels shall be configured as shown in Figure 5.2.5.

Figure 5.2.5

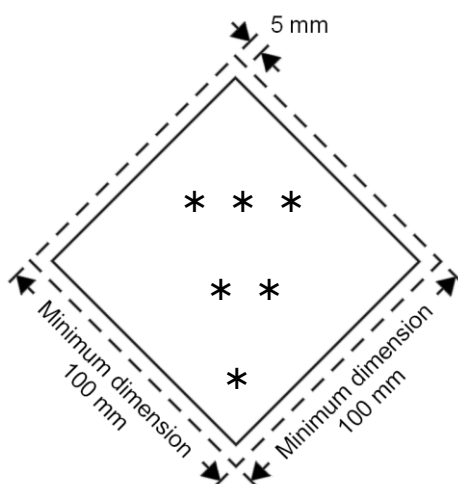

Class/division label

- * The class or, for divisions 5.1 and 5.2, the Division number shall be shown in the bottom corner
- ** Additional text/numbers/letters shall (if mandatory) or may (if optional) be shown in this bottom half
- *** The class or division symbol or, for divisions 1.4, 1.5 and 1.6, the division number and for Model No 7E the word “FISSILE” shall be shown in this top half

5.2.2.2.1.1.1 Labels shall be displayed on a background of contrasting colour, or shall have either a dotted or solid outer boundary line.

5.2.2.2.1.1.2 The label shall be in the form of a square set at an angle of 45 degrees (diamond-shaped). The minimum dimensions shall be 100 mm x 100 mm and the minimum width of the line inside the edge forming the diamond shall be 2 mm. The line inside the edge shall be parallel and 5 mm from the outside of that line to the edge of the label. The line inside the edge on the upper half of the label shall be the same colour as the symbol and the line inside the edge on the lower half of the label shall be the same colour as the class or division number in the bottom corner. Where dimensions are not specified, all features shall be in approximate proportion to those shown.

5.2.2.2.1.1.3 If the size of the package so requires the dimensions may be reduced, provided the symbols and other elements of the label remain clearly visible. The line inside the edge shall remain 5 mm to the edge of the label. The minimum width of the line inside the edge shall remain 2 mm. Dimensions for cylinders shall comply with 5.2.2.2.1.2.

NOTE: *The provisions of 5.2.2.2.1.1 from the seventeenth revised edition of the Recommendations on the Transport of Dangerous Goods, Model Regulations may continue to be applied until 31 December 2016. When so applied, 5.2.2.2.1.1.1, 5.2.2.2.1.1.2 and 5.2.2.2.1.1.3 shall not apply until 31 December 2016.*

5.2.2.2.1.2 Cylinders for Class 2 may, on account of their shape, orientation and securing mechanisms for transport, bear labels representative of those specified in this section, which have been reduced in size, according to ISO 7225:2005, for display on the non-cylindrical part (shoulder) of such cylinders. Labels may overlap to the extent provided for by ISO 7225:2005 “Gas cylinders – Precautionary labels”, however, in all cases, the labels representing the primary hazard and the numbers appearing on any label shall remain fully visible and the symbols recognisable.

5.2.2.2.1.3 With the exception of labels for divisions 1.4, 1.5 and 1.6 of Class 1, the upper half of the label shall contain the pictorial symbol and the lower half shall contain the class or division number 1, 2, 3, 4, 5.1, 5.2, 6, 7, 8 or 9 as appropriate. The label may include such text as the UN number, or words describing the hazard class (e.g. “flammable”) in accordance with 5.2.2.2.1.5 provided that the text does not obscure or detract from the other required label elements.

5.2.2.2.1.4 In addition, except for divisions 1.4, 1.5 and 1.6, labels for Class 1 shall show in the lower half, above the class number, the division number and the compatibility group letter for the substance or article. Labels for divisions 1.4, 1.5 and 1.6 shall show in the upper half the division number, and in the lower half the class number and the compatibility group letter. For Division 1.4, Compatibility Group S, no label is generally required. However, in cases where a label is considered necessary for such goods, it shall be based on model No. 1.4.

5.2.2.2.1.5 On labels other than those for material of Class 7, the insertion of any text (other than the class or division number) in the space below the symbol shall be confined to particulars indicating the nature of the risk and precautions to be taken in handling.

5.2.2.2.1.6 The symbols, text and numbers shall be shown in black on all labels except for:

- (a) The Class 8 label, where the text (if any) and class number shall appear in white;
- (b) Labels with entirely green, red or blue backgrounds where they may be shown in white;
- (c) The Division 5.2 label, where the symbol may be shown in white; and
- (d) The Division 2.1 label displayed on cylinders and gas cartridges for liquefied petroleum gases, where they may be shown in the background colour of the receptacle if adequate contrast is provided.

5.2.2.2.1.7 All labels shall be able to withstand open weather exposure without a substantial reduction in effectiveness.

5.2.2.2.2 Specimen labels

CLASS 1

Explosive substances or articles



(No. 1)

Divisions 1.1, 1.2 and 1.3

Symbol (exploding bomb): black; Background: orange; Figure '1' in bottom corner



(No. 1.4)

Division 1.4



(No. 1.5)

Division 1.5



(No. 1.6)

Division 1.6

Background: orange; Figures: black; Numerals shall be about 30 mm in height and be about 5 mm thick (for a label measuring 100 mm x 100 mm); Figure '1' in bottom corner

** Place for division - to be left blank if explosive is the subsidiary risk

* Place for compatibility group - to be left blank if explosive is the subsidiary risk

CLASS 2

Gases



(No. 2.1)

Division 2.1

Flammable gases

Symbol (flame): black or white;
(except as provided for in 5.2.2.2.1.6 (d))
Background: red; Figure '2' in bottom corner



(No. 2.2)

Division 2.2

Non-flammable, non-toxic gases

Symbol (gas cylinder): black or white;
Background: green; Figure '2' in bottom corner



CLASS 3

Flammable liquids



(No. 2.3)

Division 2.3

Toxic gases

Symbol (skull and crossbones): black;
Background: white; Figure '2' in bottom corner



(No. 3)

Symbol (flame): black or white;
Background: red; Figure '3' in bottom corner



CLASS 4



(No. 4.1)
Division 4.1
Flammable solids
Symbol (flame): black;
Background: white with
seven vertical red stripes;
Figure '4' in bottom corner



(No. 4.2)
Division 4.2
Substances liable
to spontaneous combustion
Symbol (flame): black;
Background: upper half white,
lower half red;
Figure '4' in bottom corner



(No. 4.3)
Division 4.3
Substances which, in contact
with water, emit flammable gases
Symbol (flame): black or white;
Background: blue;
Figure '4' in bottom corner



CLASS 5



(No. 5.1)
Division 5.1
Oxidizing substances
Symbol (flame over circle): black;
Background: yellow;
Figure '5.1' in bottom corner



(No. 5.2)
Division 5.2
Organic peroxides
Symbol (flame); black or white;
Background: upper half red; lower half yellow;
Figure '5.2' in bottom corner



CLASS 6



(No. 6.1)
Division 6.1
Toxic substances
Symbol (skull and crossbones): black;
Background: white; Figure '6' in bottom corner



(No. 6.2)
Division 6.2
Infectious substances
The lower half of the label may bear the inscriptions: 'INFECTIOUS SUBSTANCE'
and 'In the case of damage or leakage immediately notify Public Health Authority';
Symbol (three crescents superimposed on a circle) and inscriptions: black;
Background: white; Figure '6' in bottom corner

CLASS 7
Radioactive material



(No. 7A)
 Category I – White
 Symbol (trefoil): black;
 Background: white;
 Text (mandatory): black in lower half of label:
 'RADIOACTIVE'
 'CONTENTS'
 'ACTIVITY'
 One red bar shall follow the word 'RADIOACTIVE';
 Figure '7' in bottom corner



(No. 7B)
 Category II – Yellow
 Symbol (trefoil): black;
 Background: upper half yellow with white border, lower half white;
 Text (mandatory): black in lower half of label:
 'RADIOACTIVE'
 'CONTENTS'
 'ACTIVITY'
 In a black outlined box: 'TRANSPORT INDEX';
 Two red vertical bars shall follow the word 'RADIOACTIVE';
 Figure '7' in bottom corner



(No. 7C)
 Category III – Yellow
 Symbol (trefoil): black;
 Background: upper half yellow with white border, lower half white;
 Text (mandatory): black in lower half of label:
 'RADIOACTIVE'
 'CONTENTS'
 'ACTIVITY'
 In a black outlined box: 'TRANSPORT INDEX';
 Three red vertical bars shall follow the word 'RADIOACTIVE';
 Figure '7' in bottom corner



(No. 7E)
 Class 7 fissile material
 Background: white;
 Text (mandatory): black in upper half of label: 'FISSILE';
 In a black outlined box in the lower half of the label:
 'CRITICALITY SAFETY INDEX'
 Figure '7' in bottom corner

CLASS 8
Corrosive substances



(No. 8)
 Symbol (liquids, spilling from two glass vessels and attacking a hand and a metal): black;
 Background: upper half white;
 lower half black with white border;
 Figure '8' in bottom corner

CLASS 9
Miscellaneous dangerous substances and articles, including environmentally hazardous substances



(No. 9)
 Symbol (seven vertical stripes in upper half): black;
 Background: white;
 Figure '9' underlined in bottom corner

CHAPTER 5.3

PLACARDING AND MARKING OF CARGO TRANSPORT UNITS

5.3.1 Placarding

5.3.1.1 *Placarding provisions*

5.3.1.1.1 *Deleted.*

5.3.1.1.2 Placards shall be affixed to the exterior surface of cargo transport units to provide a warning that the contents of the unit are dangerous goods and present risks. Placards shall correspond to the primary risk of the goods contained in the cargo transport unit except that:

- (a) Placards are not required on cargo transport units carrying any quantity of explosives of Division 1.4, Compatibility Group S; and
- (b) Placards indicating the highest risk only need be affixed on cargo transport units carrying substances and articles of more than one division in Class 1.

Placards shall be displayed on a background of contrasting colour, or shall have either a dotted or solid outer boundary line.

5.3.1.1.3 Placards shall also be displayed for those subsidiary risks for which a subsidiary risk label is required according to 5.2.2.1.2. However, cargo transport units containing goods of more than one class need not bear a subsidiary risk placard if the hazard represented by that placard is already indicated by a primary risk placard.

5.3.1.1.4 Cargo transport units carrying dangerous goods or the residue of dangerous goods in unpurged tanks or empty uncleaned bulk containers shall display placards clearly visible on at least two opposing sides of the units and in any case in such a position as may be seen by all those involved in the loading or unloading process. Where the cargo transport unit has a multiple compartment tank which is carrying two or more dangerous goods and/or the residues of dangerous goods, appropriate placards shall be displayed along each side at the position of the relevant compartments.

5.3.1.1.5 *Special provisions for Class 7*

5.3.1.1.5.1 Large freight containers carrying packages other than excepted packages, and tanks shall bear four placards which conform to the model No.7D given in Figure 5.3.1. The placards shall be affixed in a vertical orientation to each side wall and each end wall of the large freight container or tank. Any placards which do not relate to the contents shall be removed. Instead of using both labels and placards, it is permitted as an alternative to use enlarged labels only, as shown in label models Nos. 7A, 7B and 7C, except having the minimum size shown in Figure 5.3.1.

5.3.1.1.5.2 Rail and road vehicles carrying packages, overpacks or freight containers labelled with any of the labels shown in 5.2.2.2.2 as models Nos. 7A, 7B, 7C and 7E, or carrying consignments under exclusive use, shall display the placard shown in Figure 5.3.1 (model No.7D) on each of:

- (a) the two external lateral walls in the case of a rail vehicle;
- (b) the two external lateral walls and the external rear wall in the case of a road vehicle.

In the case of a vehicle without sides the placards may be affixed directly on the cargo-carrying unit provided that they are readily visible; in the case of physically large tanks or freight containers,

the placards on the tanks or freight containers shall suffice. In the case of vehicles which have insufficient area to allow the fixing of larger placards, the dimensions of the placard as described in Figure 5.3.1 may be reduced to 100 mm. Any placards which do not relate to the contents shall be removed.

5.3.1.2 *Specifications for placards*

5.3.1.2.1 Except as provided in 5.3.1.2.2 for the Class 7 placard, and in 5.3.2.3.2 for the environmentally hazardous substance mark, a placard shall be configured as shown in Figure 5.3.0.

Figure 5.3.0

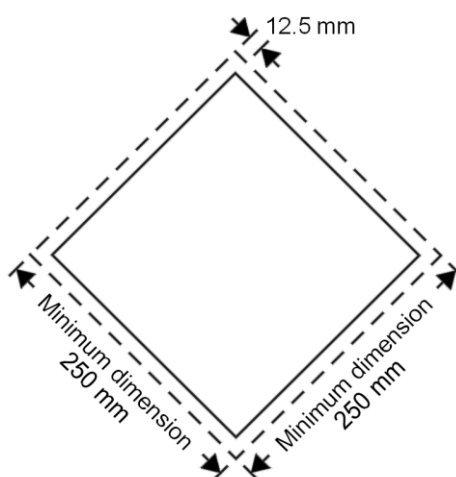

Placard (except for class 7)

The placard shall be in the form of a square set at an angle of 45 degrees (diamond-shaped). The minimum dimensions shall be 250 mm x 250 mm (to the edge of the placard). The line inside the edge shall be parallel and 12.5 mm from the outside of that line to the edge of the placard. The symbol and line inside the edge shall correspond in colour to the label for the class or division of the dangerous goods in question. The class or division symbol/numeral shall be positioned and sized in proportion to those prescribed in 5.2.2.2 for the corresponding class or division of the dangerous goods in question. The placard shall display the number of the class or division (and for goods in Class 1, the compatibility group letter) of the dangerous goods in question in the manner prescribed in 5.2.2.2 for the corresponding label, in digits not less than 25 mm high. Where dimensions are not specified, all features shall be in approximate proportion to those shown.

NOTE: *The provisions of 5.3.1.2.1 from the seventeenth revised edition of the Recommendations on the Transport of Dangerous Goods, Model Regulations may continue to be applied until 31 December 2016.*

5.3.1.2.2 For Class 7, the placard shall have minimum overall dimensions of 250 mm by 250 mm (except as permitted by 5.3.1.1.5.2) with a black line running 5 mm inside the edge and parallel with it, and shall be otherwise as shown in Figure 5.3.1 below. When different dimensions are used, the relative proportions shall be maintained. The number “7” shall not be less than 25 mm high. The background colour of the upper half of the placard shall be yellow and of the lower half white, the colour of the trefoil and the printing shall be black. The use of the word “RADIOACTIVE” in the bottom half is optional to allow the use of this placard to display the appropriate United Nations number for the consignment.

Figure 5.3.1
Placard for radioactive material of Class 7

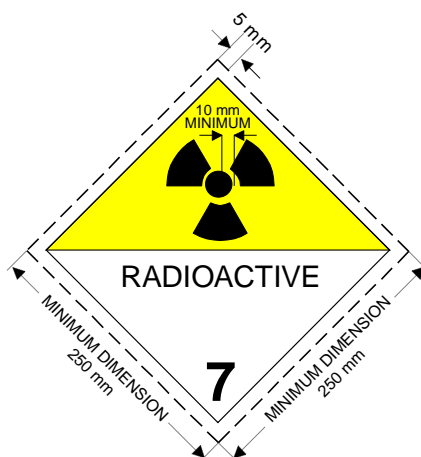

(No. 7D)

Symbol (trefoil): black; Background: upper half yellow with white border, lower half white; The lower half shall show the word RADIOACTIVE or alternatively, when required (see 5.3.2.1), the appropriate UN number; and the figure “7” in the bottom corner

5.3.2 Marking

5.3.2.1 Display of UN numbers

5.3.2.1.1 Except for goods of Class 1, the UN number shall be displayed as required by this section on consignments of:

- (a) Solids, liquids or gases transported in tank cargo transport units including on each component of a multicompartiment tank cargo transport unit;
- (b) Solids in bulk containers;
- (c) Packaged dangerous goods of a single commodity which constitute a full load for the cargo transport unit;
- (d) Unpackaged LSA-1 or SCO-1 material of Class 7 in or on a vehicle, or in a freight container, or in a tank; and
- (e) Packaged radioactive material with a single UN number in or on a vehicle, or in a freight container, when required to be transported under exclusive use.

5.3.2.1.2 The UN number for the goods shall be displayed in black digits not less than 65 mm high, either:

- (a) Against a white background in the area below the pictorial symbol and above the class or division number and the compatibility group letter in a manner that does not obscure or detract from the other required label elements (see Figures 5.3.1 and 5.3.2); or
- (b) On an orange rectangular panel not less than 120 mm high and 300 mm wide, with a 10 mm black border, to be placed immediately adjacent to each placard (see Figure 5.3.3).

5.3.2.1.3 *Examples of display of UN numbers***Figure 5.3.2**

- * location of class or division number
- ** location of UN number

Figure 5.3.35.3.2.2 *Elevated temperature substances*

Cargo transport units containing a substance that is transported or offered for transport in a liquid state at a temperature equal to or exceeding 100 °C or in a solid state at a temperature equal to or exceeding 240 °C shall bear on each side and on each end the mark shown in Figure 5.3.4.

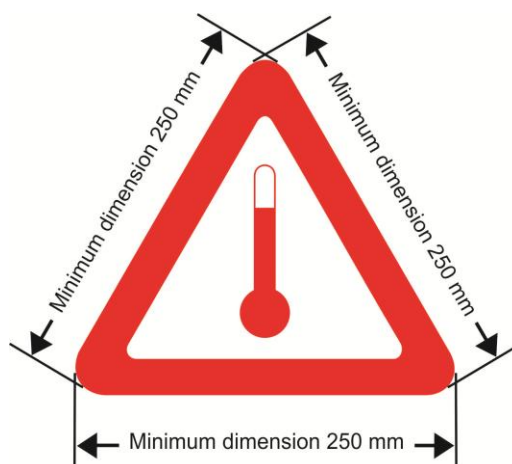
Figure 5.3.4

Mark for carriage at elevated temperature

The marking shall be an equilateral triangle. The colour of the mark shall be red. The minimum dimension of the sides shall be 250 mm. Where dimensions are not specified, all features shall be in approximate proportion to those shown.

NOTE: *The provisions of 5.3.2.2 from the seventeenth revised edition of the Recommendations on the Transport of Dangerous Goods, Model Regulations may continue to be applied until 31 December 2016.*

5.3.2.3 *Environmentally hazardous substance mark*

5.3.2.3.1 A cargo transport unit containing environmentally hazardous substances meeting the criteria of 2.9.3 (UN Nos. 3077 and 3082) shall be marked on at least two opposing sides of the unit and in any case in such a position as may be seen by all those involved in the loading or unloading processes, with the environmentally hazardous substance mark to be affixed in accordance with the provisions of 5.3.1.1.4 for placards.

5.3.2.3.2 The environmentally hazardous substance mark for cargo transport units shall be as described in 5.2.1.6.3 and Figure 5.2.2, except that the minimum dimensions shall be 250 mm x 250 mm.

NOTE: *The requirements of 5.3.2.3.2 shall apply as from 1st January 2017.*

CHAPTER 5.4

DOCUMENTATION

Introductory note

NOTE: *These Regulations do not preclude the use of electronic data processing (EDP) and electronic data interchange (EDI) transmission techniques as an alternative to paper documentation. All references to “dangerous goods transport document” in this Chapter also include provision of the required information by use of EDP and EDI transmission techniques.*

5.4.1 Dangerous goods transport information

5.4.1.1 General

5.4.1.1.1 Except as otherwise provided, the consignor who offers dangerous goods for transport shall give to the carrier the information applicable to those dangerous goods, including any additional information and documentation as specified in these Regulations. This information may be provided on a dangerous goods transport document or, with the agreement of the carrier, by EDP or EDI techniques.

5.4.1.1.2 When a paper document is used, the consignor shall give the initial carrier a copy of the dangerous goods transport document, completed and signed as required in this Chapter.

5.4.1.1.3 When the dangerous goods transport information is given to the carrier by EDP or EDI techniques, the consignor shall be able to produce the information without delay as a paper document, with the information in the sequence required by this Chapter.

5.4.1.2 Form of the transport document

5.4.1.2.1 A dangerous goods transport document may be in any form, provided it contains all of the information required by these Regulations.

5.4.1.2.2 If both dangerous and non-dangerous goods are listed in one document, the dangerous goods shall be listed first, or otherwise be emphasised.

5.4.1.2.3 Continuation page

A dangerous goods transport document may consist of more than one page, provided pages are consecutively numbered.

5.4.1.2.4 The information on a dangerous goods transport document shall be easy to identify, legible and durable.

5.4.1.2.5 *Example of a dangerous goods transport document*

The form shown in Figure 5.4.1 at the end of this Chapter is an example of a dangerous goods transport document¹.

5.4.1.3 *Consignor, consignee and date*

The name and address of the consignor and the consignee of the dangerous goods shall be included on the dangerous goods transport document. The date the dangerous goods transport document or an electronic copy of it was prepared or given to the initial carrier shall be included.

5.4.1.4 *Information required on the dangerous goods transport document*

5.4.1.4.1 *Dangerous goods description*

The dangerous goods transport document shall contain the following information for each dangerous substance, material or article offered for transport:

- (a) The UN number preceded by the letters “UN”;
- (b) The proper shipping name, as determined according to 3.1.2, including the technical name enclosed in parenthesis, as applicable (see 3.1.2.8);
- (c) The primary hazard class or, when assigned, the division of the goods, including for Class 1, the compatibility group letter. The words “Class” or “Division” may be included preceding the primary hazard class or division numbers;
- (d) Subsidiary hazard class or division number(s) corresponding to the subsidiary risk label(s) required to be applied, when assigned, shall be entered following the primary hazard class or division and shall be enclosed in parenthesis. The words “Class” or “Division” may be included preceding the subsidiary hazard class or division numbers;
- (e) Where assigned, the packing group for the substance or article which may be preceded by “PG” (e.g. “PG II”).

¹ For standardized formats, see also the relevant recommendations of the UNECE United Nations Centre for Trade Facilitation and Electronic Business (UN/CEFACT), in particular Recommendation No. 1 (United Nations Lay-out Key for Trade Documents) (ECE/TRADE/137, edition 81.3), UN Layout Key for Trade Documents - Guidelines for Applications (ECE/TRADE/270, edition 2002), Revised Recommendation No. 11 (Documentary Aspects of the International Transport of Dangerous Goods) (ECE/TRADE/C/CEFACT/2008/8) and Recommendation No. 22 (Lay-out Key for standard Consignment Instructions) (ECE/TRADE/168, edition 1989). Refer also to the UN/CEFACT Summary of Trade Facilitation Recommendations (ECE/TRADE/346, edition 2006) and the United Nations Trade Data Elements Directory (UNTDDED) (ECE/TRADE/362, edition 2005).

5.4.1.4.2 *Sequence of the dangerous goods description*

The five elements of the dangerous goods description specified in 5.4.1.4.1 shall be shown in the order listed above (i.e. (a), (b), (c), (d), (e)) with no information interspersed, except as provided in these Regulations. Examples of a dangerous goods description are:

UN1098 ALLYL ALCOHOL 6.1 (3) I
UN1098, ALLYL ALCOHOL, Division 6.1, (Class 3), PG I

NOTE: *In addition to the requirements of these Regulations, other elements of information may be required by the competent authority or for certain modes of transport (e.g. flash point for sea transport). Unless permitted or required by these Regulations, additional information shall be placed after the dangerous goods description.*

5.4.1.4.3 *Information which supplements the proper shipping name in the dangerous goods description*

The proper shipping name in the dangerous goods description shall be supplemented as follows:

- (a) Technical names for “n.o.s.” and other generic descriptions: Proper shipping names that are assigned special provision 274 or 318 in Column 6 of the Dangerous Goods List shall be supplemented with their technical or chemical group names as described in 3.1.2.8;
- (b) Empty uncleaned packagings, bulk containers and tanks: Empty means of containment (including packagings, IBCs, bulk containers, portable tanks, tank-vehicles and tank-wagons) which contain the residue of dangerous goods of classes other than Class 7 shall be described as such by, for example, placing the words “**EMPTY UNCLEANED**” or “**RESIDUE LAST CONTAINED**” before or after the dangerous goods description specified in 5.4.1.4.1 (a) to (e);
- (c) Wastes: For waste dangerous goods (other than radioactive wastes) which are being transported for disposal, or for processing for disposal, the proper shipping name shall be preceded by the word “**WASTE**”, unless this is already a part of the proper shipping name;
- (d) Elevated temperature substances: If the proper shipping name of a substance which is transported or offered for transport in a liquid state at a temperature equal to or exceeding 100 °C, or in a solid state at a temperature equal to or exceeding 240 °C, does not convey the elevated temperature condition (for example, by using the term “**MOLTEN**” or “**ELEVATED TEMPERATURE**” as part of the shipping name), the word “**HOT**” shall immediately precede the proper shipping name.

5.4.1.5 *Information required in addition to the dangerous goods description*

In addition to the dangerous goods description the following information shall be included after the dangerous goods description on the dangerous goods transport document.

5.4.1.5.1 *Total quantity of dangerous goods*

Except for empty uncleaned packagings, the total quantity of dangerous goods covered by the description (by volume or mass as appropriate) of each item of dangerous goods bearing a different proper shipping name, UN number or packing group shall be included. For Class 1 dangerous goods, the quantity shall be the net explosive mass. For dangerous goods transported in salvage packagings, an estimate of the quantity of dangerous goods shall be given. The number and kind (e.g. drum, box, etc.) of packages shall also be indicated. UN packaging codes may only be used to supplement the description of the kind of

package (e.g. one box (4G)). Abbreviations may be used to specify the unit of measurement for the total quantity.

NOTE: *The number, type and capacity of each inner packaging within the outer packaging of a combination packaging is not required to be indicated.*

5.4.1.5.2 *Limited quantities*

When dangerous goods are transported according to the exceptions for dangerous goods packed in limited quantities provided for in Column 7a of the Dangerous Goods List and Chapter 3.4, the words “**limited quantity**” or “**LTD QTY**” shall be included.

5.4.1.5.3 *Salvage packagings and salvage pressure receptacles*

For dangerous goods transported in salvage packagings or salvage pressure receptacles, the words “**SALVAGE PACKAGING**” or “**SALVAGE PRESSURE RECEPTACLE**” shall be included.

5.4.1.5.4 *Substances stabilized by temperature control*

If the word “STABILIZED” is part of the proper shipping name (see also 3.1.2.6), when stabilization is by means of temperature control, the control and emergency temperatures (see 7.1.5.3.1) shall be indicated in the transport document, as follows:

“Control temperature: °C Emergency temperature: °C”

5.4.1.5.5 *Self-reactive substances and organic peroxides*

For self-reactive substances of Division 4.1 and for organic peroxides which require temperature control during transport, the control and emergency temperatures (see 7.1.5.3.1) shall be indicated on the dangerous goods transport document, as follows:

“Control temperature: °C Emergency temperature: °C”

5.4.1.5.5.1 When for certain self-reactive substances of Division 4.1 and organic peroxides of Division 5.2 the competent authority has permitted the “EXPLOSIVE” subsidiary risk label (model No. 1) to be dispensed with for the specific package, a statement to this effect shall be included.

5.4.1.5.5.2 When organic peroxides and self-reactive substances are transported under conditions where approval is required (for organic peroxides, see 2.5.3.2.5, 4.1.7.2.2, 4.2.1.13.1 and 4.2.1.13.3; for self-reactive substances, see 2.4.2.3.2.4 and 4.1.7.2.2), a statement to this effect shall be included in the dangerous goods transport document. A copy of the classification approval and conditions of transport for non-listed organic peroxides and self-reactive substances shall be attached to the dangerous goods transport document.

5.4.1.5.5.3 When a sample of an organic peroxide (see 2.5.3.2.5.1) or a self-reactive substance (see 2.4.2.3.2.4(b)) is transported, a statement to this effect shall be included in the dangerous goods transport document.

5.4.1.5.6 *Infectious substances*

The full address of the consignee shall be shown on the document, together with the name of a responsible person and his telephone number.

5.4.1.5.7 *Radioactive material*

5.4.1.5.7.1 The following information shall be included for each consignment of Class 7 material, as applicable, in the order given:

- (a) The name or symbol of each radionuclide or, for mixtures of radionuclides, an appropriate general description or a list of the most restrictive nuclides;
- (b) A description of the physical and chemical form of the material, or a notation that the material is special form radioactive material or low dispersible radioactive material. A generic chemical description is acceptable for chemical form;
- (c) The maximum activity of the radioactive contents during transport expressed in units of becquerels (Bq) with an appropriate SI prefix symbol (see 1.2.2.1). For fissile material, the mass of fissile material (or mass of each fissile nuclide for mixtures when appropriate) in units of grams (g), or appropriate multiples thereof, may be used in place of activity;
- (d) The category of the package, i.e. I-WHITE, II-YELLOW, III-YELLOW;
- (e) The transport index (categories II-YELLOW and III-YELLOW only);
- (f) For fissile material:
 - (i) Shipped under one exception of 2.7.2.3.5 (a) to (f), reference to that paragraph;
 - (ii) Shipped under 2.7.2.3.5 (c) to (e), the total mass of fissile nuclides;
 - (iii) Contained in a package for which one of 6.4.11.2 (a) to (c) or 6.4.11.3 is applied, reference to that paragraph;
 - (iv) The criticality safety index, where applicable.;
- (g) The identification mark for each competent authority certificate of approval (special form radioactive material, low dispersible radioactive material, fissile material excepted under 2.7.2.3.5 (f), special arrangement, package design, or shipment) applicable to the consignment;
- (h) For consignments of more than one package, the information contained in 5.4.1.4.1 (a) to (c) and 5.4.1.5.7.1 (a) to (g) shall be given for each package. For packages in an overpack, freight container, or conveyance, a detailed statement of the contents of each package within the overpack, freight container, or conveyance and, where appropriate, of each overpack, freight container, or conveyance shall be included. If packages are to be removed from the overpack, freight container, or conveyance at a point of intermediate unloading, appropriate transport documents shall be made available;
- (i) Where a consignment is required to be shipped under exclusive use, the statement "EXCLUSIVE USE SHIPMENT"; and
- (j) For LSA-II, LSA-III, SCO-I and SCO-II, the total activity of the consignment as a multiple of A_2 . For radioactive material for which the A_2 value is unlimited, the multiple of A_2 shall be zero.

5.4.1.5.7.2 The transport document shall include a statement regarding actions, if any, that are required to be taken by the carrier. The statement shall be in the languages deemed necessary by the carrier or the authorities concerned, and shall include at least the following points:

- (a) Supplementary requirements for loading, stowage, transport, handling and unloading of the package, overpack or freight container including any special stowage provisions for the safe dissipation of heat (see 7.1.8.3.2), or a statement that no such requirements are necessary;
- (b) Restrictions on the mode of transport or conveyance and any necessary routing instructions;
- (c) Emergency arrangements appropriate to the consignment.

5.4.1.5.7.3 In all cases of international transport of packages requiring competent authority approval of design or shipment, for which different approval types apply in the different countries concerned by the shipment, the UN number and proper shipping name required in 5.4.1.4.1 shall be in accordance with the certificate of the country of origin of design.

5.4.1.5.7.4 The applicable competent authority certificates need not necessarily accompany the consignment. The consignor shall make them available to the carrier(s) before loading and unloading.

5.4.1.5.8 *Transport of solids in bulk containers*

For bulk containers other than freight containers, the following statement shall be shown on the transport document (see 6.8.4.6):

“Bulk container BK(x) approved by the competent authority of...”

5.4.1.5.9 *Transport of IBCs or portable tanks after the date of expiry of the last periodic test or inspection*

For transport in accordance with 4.1.2.2 (b), 6.7.2.19.6 (b), 6.7.3.15.6 (b) or 6.7.4.14.6 (b), a statement to this effect shall be included in the transport document, as follows: “Transport in accordance with 4.1.2.2 (b)”, “Transport in accordance with 6.7.2.19.6 (b)”, “Transport in accordance with 6.7.3.15.6 (b)” or “Transport in accordance with 6.7.4.14.6 (b)” as appropriate.

5.4.1.5.10 *Firework classification reference*

When fireworks of UN Nos. 0333, 0334, 0335, 0336 and 0337 are transported, the dangerous goods transport document shall include a classification reference(s) issued by the competent authority.

The classification reference(s) shall consist of the competent authority’s state, indicated by the distinguishing sign for motor vehicles in international traffic, the competent authority identification and a unique serial reference. Examples of such classification references are:

GB/HSE123456
D/BAM1234
USA EX20091234.

5.4.1.6 **Certification**

5.4.1.6.1 The dangerous goods transport document shall include a certification or declaration that the consignment is acceptable for transport and that the goods are properly packaged, marked and labelled, and in proper condition for transport in accordance with the applicable regulations. The text for this certification is:

“I hereby declare that the contents of this consignment are fully and accurately described above² by the proper shipping name, and are classified, packaged, marked and

² or below

labelled/placarded, and are in all respects in proper condition for transport according to applicable international and national governmental regulations.”

The certification shall be signed and dated by the consignor. Facsimile signatures are acceptable where applicable laws and regulations recognize the legal validity of facsimile signatures.

5.4.1.6.2 If the dangerous goods documentation is presented to the carrier by means of EDP or EDI transmission techniques, the signature(s) may be electronic signature(s) or may be replaced by the name(s) (in capitals) of the person authorized to sign.

5.4.1.6.3 When the dangerous goods transport information is given to a carrier by EDP or EDI techniques and subsequently the dangerous goods are transferred to a carrier that requires a paper dangerous goods transport document, the carrier shall ensure that the paper document indicates “Original received electronically” and the name of the signatory shall be shown in capital letters.

5.4.2 Container/vehicle packing certificate

5.4.2.1 When dangerous goods are packed or loaded into any container³ or vehicle which will be transported by sea, those responsible for packing of the container or vehicle shall provide a “container/vehicle packing certificate” specifying the container/vehicle identification number(s) and certifying that the operation has been carried out in accordance with the following conditions:

- (a) The container/vehicle was clean, dry and apparently fit to receive the goods;
- (b) Packages, which need to be segregated in accordance with applicable segregation requirements, have not been packed together onto or in the container/vehicle;
- (c) All packages have been externally inspected for damage, and only sound packages have been loaded;
- (d) All goods have been properly loaded and, where necessary, adequately braced with securing material to suit the mode(s) of transport for the intended journey;
- (e) Goods loaded in bulk have been evenly distributed within the container/vehicle;
- (f) For consignments including goods of Class 1 other than Division 1.4, the container/vehicle is structurally serviceable in accordance with 7.1.3.2.1;
- (g) The container/vehicle and packages are properly marked, labelled and placarded, as appropriate;
- (h) When substances presenting a risk of asphyxiation are used for cooling or conditioning purposes (such as dry ice (UN 1845) or nitrogen, refrigerated liquid (UN 1977) or argon, refrigerated liquid (UN 1951)), the container/vehicle is externally marked in accordance with 5.5.3.6; and
- (i) A dangerous goods transport document, as indicated in 5.4.1.1, has been received for each dangerous goods consignment loaded in the container/vehicle.

NOTE: *The container/vehicle packing certificate is not required for tanks.*

³ *Container means an article of transport equipment that is of a permanent character and accordingly strong enough to be suitable for repeated use; specially designed to facilitate the transport of goods, by one or more modes of transport, without intermediate reloading; designed to be secured and/or readily handled, having fittings for these purposes, and approved in accordance with the International Convention for Safe Containers (CSC), 1972, as amended. The term “container” includes neither vehicle nor packaging. However, a container that is transported on a chassis is included.*

5.4.2.2 The information required in the dangerous goods transport document and the container/vehicle packing certificate may be incorporated into a single document, if not, these documents shall be attached one to the other. If the information is incorporated into a single document, the document shall include a signed declaration such as “It is declared that the packing of the goods into the container/vehicle has been carried out in accordance with the applicable provisions”. This declaration shall be dated and the person signing this declaration shall be identified on the document. Facsimile signatures are acceptable where applicable laws and regulations recognize the legal validity of facsimile signatures.

5.4.2.3 If the container/vehicle packing certificate is presented to the carrier by means of EDP or EDI transmission techniques, the signature(s) may be electronic signature(s) or may be replaced by the name(s) (in capitals) of the person authorized to sign.

5.4.2.4 When the container/vehicle packing certificate is given to a carrier by EDP or EDI techniques and subsequently the dangerous goods are transferred to a carrier that requires a paper dangerous goods transport document, the carrier shall ensure that the paper document indicates “Original received electronically” and the name of the signatory shall be shown in capital letters.

5.4.3 Emergency response information

For consignments for which a dangerous goods transport document is required by these Regulations, appropriate information shall be immediately available at all times for use in emergency response to accidents and incidents involving dangerous goods in transport. The information shall be available away from the packages containing the dangerous goods and immediately accessible in the event of an accident or incident. Methods of compliance include:

- (a) Appropriate entries in the transport document; or
- (b) Provision of a separate document such as a safety data sheet; or
- (c) Provision of a separate document, such as the International Civil Aviation Organization (ICAO) “Emergency Response Guidance for Aircraft Incidents Involving Dangerous Goods” or the International Maritime Organization (IMO) “Emergency Procedures for Ships Carrying Dangerous Goods” and “Medical First Aid Guide in Accidents Involving Dangerous Goods”, for use in conjunction with the transport document.

5.4.4 Retention of dangerous goods transport information

5.4.4.1 The consignor shall retain a copy of the dangerous goods transport document and additional information and documentation as specified in these Regulations, for a minimum period of three months.

5.4.4.2 When the documents are kept electronically or in a computer system, the consignor shall be able to reproduce them in a printed form.

Figure 5.4.1: Multimodal Dangerous Goods Form (next page)

CHAPTER 5.5

SPECIAL PROVISIONS

5.5.1 *Deleted.*

5.5.2 **Special provisions applicable to fumigated cargo transport units (UN 3359)**

5.5.2.1 *General*

5.5.2.1.1 Fumigated cargo transport units (UN 3359) containing no other dangerous goods are not subject to any provisions of these Regulations other than those of this section.

5.5.2.1.2 When the fumigated cargo transport unit is loaded with dangerous goods in addition to the fumigant, any provision of these Regulations relevant to these goods (including placarding, marking and documentation) applies in addition to the provisions of this section.

5.5.2.1.3 Only cargo transport units that can be closed in such a way that the escape of gas is reduced to a minimum shall be used for the transport of cargo under fumigation.

5.5.2.2 *Training*

Persons engaged in the handling of fumigated cargo transport units shall be trained commensurate with their responsibilities.

5.5.2.3 *Marking and placarding*

5.5.2.3.1 A fumigated cargo transport unit shall be marked with a warning mark, as specified in 5.5.2.3.2, affixed at each access point in a location where it will be easily seen by persons opening or entering the cargo transport unit. This mark shall remain on the cargo transport unit until the following provisions are met:

- (a) The fumigated cargo transport unit has been ventilated to remove harmful concentrations of fumigant gas; and
- (b) The fumigated goods or materials have been unloaded.

5.5.2.3.2 The fumigation warning mark shall be as shown in Figure 5.5.1.

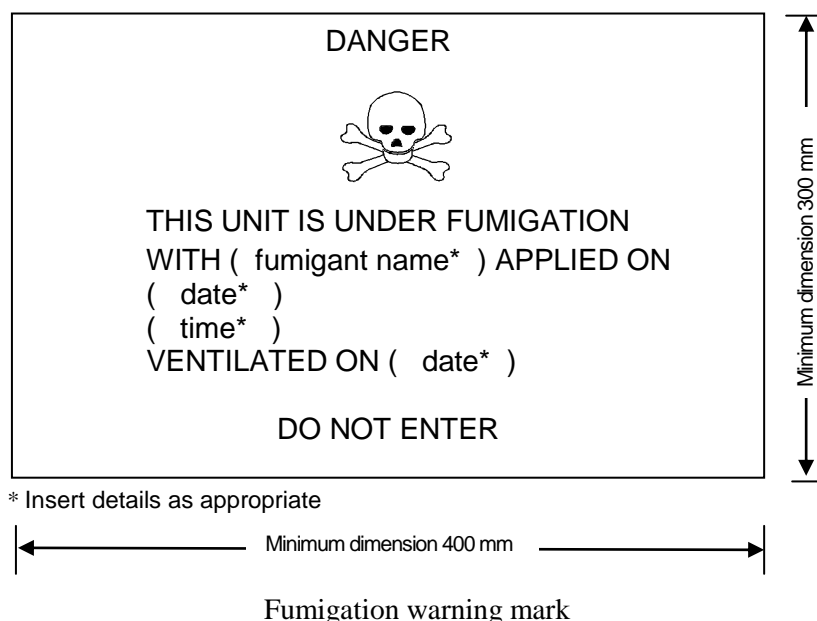
Figure 5.5.1

The marking shall be a rectangle. The minimum dimensions shall be 400 mm wide x 300 mm high and the minimum width of the outer line shall be 2 mm. The marking shall be in black print on a white background with lettering not less than 25 mm high. Where dimensions are not specified, all features shall be in approximate proportion to those shown.

NOTE: *The provisions of 5.5.2.3.2 from the seventeenth revised edition of the Recommendations on the Transport of Dangerous Goods, Model Regulations may continue to be applied until 31 December 2016.*

5.5.2.3.3 If the fumigated cargo transport unit has been completely ventilated either by opening the doors of the unit or by mechanical ventilation after fumigation, the date of ventilation shall be marked on the fumigation warning mark.

5.5.2.3.4 When the fumigated cargo transport unit has been ventilated and unloaded, the fumigation warning mark shall be removed.

5.5.2.3.5 Class 9 placards (Model No. 9, see 5.2.2.2.2) shall not be affixed to a fumigated cargo transport unit except as required for other Class 9 substances or articles packed therein.

5.5.2.4 Documentation

5.5.2.4.1 Documents associated with the transport of cargo transport units that have been fumigated and have not been completely ventilated before transport shall include the following information:

- UN 3359, fumigated cargo transport unit, 9, or UN 3359, fumigated cargo transport unit, class 9;
- The date and time of fumigation; and
- The type and amount of the fumigant used.

5.5.2.4.2 The transport document may be in any form, provided it contains the information required in 5.5.2.4.1. This information shall be easy to identify, legible and durable.

5.5.2.4.3 Instructions for disposal of any residual fumigant including fumigation devices (if used) shall be provided.

5.5.2.4.4 A document is not required when the fumigated cargo transport unit has been completely ventilated and the date of ventilation has been marked on the warning mark (see 5.5.2.3.3 and 5.5.2.3.4).

5.5.3 Special provisions applicable to packages and cargo transport units containing substances presenting a risk of asphyxiation when used for cooling or conditioning purposes (such as dry ice (UN 1845) or nitrogen, refrigerated liquid (UN 1977) or argon, refrigerated liquid (UN 1951))

5.5.3.1 *Scope*

5.5.3.1.1 This section is not applicable to substances which may be used for cooling or conditioning purposes when transported as a consignment of dangerous goods. When they are transported as a consignment, these substances shall be transported under the relevant entry of the Dangerous Goods List in Chapter 3.2 in accordance with the associated conditions of transport.

5.5.3.1.2 This section is not applicable to gases in cooling cycles.

5.5.3.1.3 Dangerous goods used for cooling or conditioning portable tanks or MEGCs during transport are not subject to this section.

5.5.3.1.4 Cargo transport units containing substances used for cooling or conditioning purposes include cargo transport units containing substances used for cooling or conditioning purposes inside packages as well as cargo transport units with unpackaged substances used for cooling or conditioning purposes.

5.5.3.2 *General*

5.5.3.2.1 Cargo transport units containing substances used for cooling or conditioning purposes (other than fumigation) during transport are not subject to any provisions of these Regulations other than those of this section.

5.5.3.2.2 When dangerous goods are loaded in cargo transport units containing substances used for cooling or conditioning purposes any provisions of these Regulations relevant to these dangerous goods apply in addition to the provisions of this section.

5.5.3.2.3 For air transport, arrangements between consignor and operator shall be made for each consignment, to ensure that ventilation safety procedures are followed.

5.5.3.2.4 Persons engaged in the handling or transport of cargo transport units containing substances used for cooling or conditioning purposes shall be trained commensurate with their responsibilities.

5.5.3.3 *Packages containing a coolant or conditioner*

5.5.3.3.1 Packaged dangerous goods requiring cooling or conditioning assigned to packing instructions P203, P620, P650, P800, P901 or P904 of 4.1.4.1 shall meet the appropriate requirements of that packing instruction.

5.5.3.3.2 For packaged dangerous goods requiring cooling or conditioning assigned to other packing instructions, the packages shall be capable of withstanding very low temperatures and shall not be affected or significantly weakened by the coolant or conditioner. Packages shall be designed and constructed to permit the release of gas to prevent a build-up of pressure that could rupture the packaging. The dangerous goods shall be packed in such a way as to prevent movement after the dissipation of any coolant or conditioner.

5.5.3.3.3 Packages containing a coolant or conditioner shall be transported in well ventilated cargo transport units.

5.5.3.4 *Marking of packages containing a coolant or conditioner*

5.5.3.4.1 Packages containing dangerous goods used for cooling or conditioning shall be marked with the proper shipping name of these dangerous goods followed by the words “AS COOLANT” or “AS CONDITIONER” as appropriate.

5.5.3.4.2 The markings shall be durable, legible and placed in such a location and of such a size relative to the package as to be readily visible.

5.5.3.5 *Cargo transport units containing unpackaged dry ice*

5.5.3.5.1 If dry ice in unpackaged form is used, it shall not come into direct contact with the metal structure of a cargo transport unit to avoid embrittlement of the metal. Measures shall be taken to provide adequate insulation between the dry ice and the cargo transport unit by providing a minimum of 30 mm separation (e.g. by using suitable low heat conducting materials such as timber planks, pallets etc).

5.5.3.5.2 Where dry ice is placed around packages, measures shall be taken to ensure that packages remain in the original position during transport after the dry ice has dissipated.

5.5.3.6 *Marking of cargo transport units*

5.5.3.6.1 Cargo transport units containing dangerous goods used for cooling or conditioning purposes shall be marked with a warning mark, as specified in 5.5.3.6.2 affixed at each access point in a location where it will be easily seen by persons opening or entering the cargo transport unit. This mark shall remain on the cargo transport unit until the following provisions are met:

- (a) The cargo transport unit has been ventilated to remove harmful concentrations of coolant or conditioner; and
- (b) The cooled or conditioned goods have been unloaded.

5.5.3.6.2 The warning mark shall be as shown in Figure 5.5.2

Figure 5.5.2



Coolant/conditioning warning mark for cargo transport units

* Insert proper shipping name of the coolant/conditioner. The lettering shall be in capitals, all be on one line and shall be at least 25 mm high. If the length of the proper shipping name is too long to fit in the space provided, the lettering may be reduced to the maximum size possible to fit. For example: CARBON DIOXIDE, SOLID

** Insert “AS COOLANT” or “AS CONDITIONER” as appropriate. The lettering shall be in capitals, all be on one line and be at least 25 mm high

The marking shall be a rectangle. The minimum dimensions shall be 150 mm wide x 250 mm high. The word “WARNING” shall be in red or white and be at least 25 mm high. Where dimensions are not specified, all features shall be in approximate proportion to those shown.

NOTE: *The provisions of 5.5.3.6.2 from the seventeenth revised edition of the Recommendations on the Transport of Dangerous Goods, Model Regulations may continue to be applied until 31 December 2016.*

5.5.3.7 Documentation

5.5.3.7.1 Documents (such as a bill of lading or cargo manifest) associated with the transport of cargo transport units containing or have contained substances used for cooling or conditioning purposes and have not been completely ventilated before transport shall include the following information:

- (a) The UN number preceded by the letters “UN”; and
- (b) The proper shipping name followed by the words “AS COOLANT” or “AS CONDITIONER” as appropriate.

For example: UN 1845, CARBON DIOXIDE, SOLID, AS COOLANT.

5.5.3.7.2 The transport document may be in any form, provided it contains the information required in 5.5.3.7.1. This information shall be easy to identify, legible and durable.

